Caution



Do not exceed the operating input power, voltage, and current level and signal type appropriate for the instrument being used, refer to your instrument's Function Reference.



Electrostatic discharge(ESD) can damage the highly sensitive microcircuits in your instrument. ESD damage is most likely to occur as the test fixtures are being connected or disconnected. Protect them from ESD damage by wearing a grounding strap that provides a high resistance path to ground. Alternatively, ground yourself to discharge any static charge built-up by touching the outer shell of any grounded instrument chassis before touching the test port connectors.

Safety Summary

When you notice any of the unusual conditions listed below, immediately terminate operation and disconnect the power cable.

Contact your local Agilent Technologies sales representative or authorized service company for repair of the instrument. If you continue to operate without repairing the instrument, there is a potential fire or shock hazard for the operator.

- Instrument operates abnormally.
- Instrument emits abnormal noise, smell, smoke or a spark-like light during operation.
- Instrument generates high temperature or electrical shock during operation.
- Power cable, plug, or receptacle on instrument is damaged.
- Foreign substance or liquid has fallen into the instrument.

Herstellerbescheinigung

GERÄUSCHEMISSION

LpA < 70 dB
am Arbeitsplatz
normaler Betrieb
nach DIN 45635 T. 19

Manufacturer's Declaration

ACOUSTIC NOISE EMISSION

LpA < 70 dB
operator position
normal operation
per ISO 7779

Regulatory compliance information

This product complies with the essential requirements of the following applicable European Directives, and carries the CE marking accordingly:

The Low Voltage Directive 73/23/EEC, amended by 93/68/EEC

The EMC Directive 89/336/EEC, amended by 93/68/EEC

To obtain Declaration of Conformity, please contact your local Agilent Technologies sales office, agent or distributor.

Safety notice supplement

- This equipment complies with EN/IEC61010-1:2001.
- This equipment is MEASUREMENT CATEGORY I (CAT I). Do not use for CAT II, III, or IV.
- Do not connect the measuring terminals to mains.
- This equipment is POLLUTION DEGREE 2, INDOOR USE product.
- This equipment is tested with stand-alone condition or with the combination with the accessories supplied by Agilent Technologies against the requirement of the standards described in the Declaration of Conformity. If it is used as a system component, compliance of related regulations and safety requirements are to be confirmed by the builder of the system.

Agilent E5070B/E5071B ENA Series RF Network Analyzers

User's Guide

Tenth Edition

FIRMWARE REVISIONS

This manual applies directly to instruments that have the firmware revision A.08.00.

For additional information about firmware revisions, see Appendix A.



Agilent Technologies

Manufacturing No. E5070-90420

February 2007

Notices

The information contained in this document is subject to change without notice.

This document contains proprietary information that is protected by copyright. All rights are reserved. No part of this document may be photocopied, reproduced, or translated to another language without the prior written consent of Agilent Technologies.

Microsoft®, MS-DOS®, Windows®, Visual C++®, Visual Basic®, VBA® and Excel® are registered

UNIX is a registered trademark in U.S. and other countries, licensed exclusively through X/Open Company Limited.

Portions ©Copyright 1996, Microsoft Corporation. All rights reserved.

© Copyright 2002, 2003, 2004, 2005, 2006, 2007 Agilent Technologies

Manual Printing History

The manual's printing date and part number indicate its current edition. The printing date changes when a new edition is printed (minor corrections and updates that are incorporated at reprint do not cause the date to change). The manual part number changes when extensive technical changes are incorporated.

August 2002	First Edition (part number: E5070-90030)
March 2003	Second Edition (part number: E5070-90040, changes for firmware version A.03.50)
July 2003	Third Edition (part number: E5070-90050)
January 2004	Fourth Edition (part number: E5070-90060, changes for firmware version A.03.60)
March 2004	Fifth Edition (part number: E5070-90070)
August 2004	Sixth Edition (part number: E5070-90080, changes for firmware version A.04.00)
May 2005	Seventh Edition (part number: E5070-90090, changes for firmware version A.05.00)
November 2005	Eighth Edition (part number: E5070-90400, changes for firmware version A.06.00)
May 2006	Ninth Edition (part number: E5070-90410, changes for firmware version A.06.50)
February 2006	Tenth Edition (part number: E5070-90420, changes for firmware version A.08.00)

Safety Summary

The following general safety precautions must be observed during all phases of operation, service, and repair of this instrument. Failure to comply with these precautions or with specific WARNINGS elsewhere in this manual may impair the protection provided by the equipment. Such noncompliance would also violate safety standards of design, manufacture, and intended use of the instrument. Agilent Technologies assumes no liability for the customer's failure to comply with these precautions.

NOTE

The E5070B/E5071B complies with INSTALLATION CATEGORY II as well as POLLUTION DEGREE 2 in IEC61010-1. The E5070B/E5071B is an INDOOR USE product.

NOTE

The LEDs in the E5070B/E5071B are Class 1 in accordance with IEC60825-1, CLASS 1 LED PRODUCT.

- Ground the Instrument
To avoid electric shock, the instrument chassis and cabinet must be grounded with the supplied power cable's grounding prong.
- DO NOT Operate in an Explosive Atmosphere
Do not operate the instrument in the presence of inflammable gasses or fumes. Operation of any electrical instrument in such an environment clearly constitutes a safety hazard.
- Keep Away from Live Circuits
Operators must not remove instrument covers. Component replacement and internal adjustments must be made by qualified maintenance personnel. Do not replace components with the power cable connected. Under certain conditions, dangerous voltage levels may remain even after the power cable has been disconnected. To avoid injuries, always disconnect the power and discharge circuits before touching them.
- DO NOT Service or Adjust the Instrument Alone
Do not attempt internal service or adjustment unless another person, capable of rendering first aid and resuscitation, is present.
- DO NOT Substitute Parts or Modify the Instrument
To avoid the danger of introducing additional hazards, do not install substitute parts or perform unauthorized modifications to the instrument. Return the instrument to an Agilent Technologies Sales and Service Office for service and repair to ensure that safety features are maintained in operational condition.
- Dangerous Procedure Warnings
Warnings, such as the example below, precede potentially dangerous procedures throughout this manual. Instructions contained in the warnings must be followed.

WARNING

Dangerous voltage levels, capable of causing death, are present in this instrument. Use extreme caution when handling, testing, and adjusting this instrument.

Safety Symbols

General definitions of safety symbols used on the instrument or in manuals are listed below.



Instruction Manual symbol: the product is marked with this symbol when it is necessary for the user to refer to the instrument manual.



Alternating current.



Direct current.



On (Supply).



Off (Supply).



In-position of push-button switch.



Out-position of push-button switch.



A chassis terminal; a connection to the instrument's chassis, which includes all exposed metal structure.



Stand-by.

WARNING

This warning sign denotes a hazard. It calls attention to a procedure, practice, or condition that, if not correctly performed or adhered to, could result in injury or death to personnel.

CAUTION

This Caution sign denotes a hazard. It calls attention to a procedure, practice, or condition that, if not correctly performed or adhered to, could result in damage to or destruction of part or all of the instrument.

NOTE

This Note sign denotes important information. It calls attention to a procedure, practice, or condition that is essential for the user to understand.

Certification

Agilent Technologies certifies that this product met its published specifications at the time of shipment from the factory. Agilent Technologies further certifies that its calibration measurements are traceable to the United States National Institute of Standards and Technology, to the extent allowed by the Institution's calibration facility or by the calibration facilities of other International Standards Organization members.

Documentation Warranty

The material contained in this document is provided "as is," and is subject to being changed, without notice, in future editions. Further, to the maximum extent permitted by applicable law, Agilent disclaims all warranties, either express or implied with regard to this manual and any information contained herein, including but not limited to the implied warranties of merchantability and fitness for a particular purpose. Agilent shall not be liable for errors or for incidental or consequential damages in connection with the furnishing, use, or performance of this document or any information contained herein. Should Agilent and the user have a separate written agreement with warranty terms covering the material in this document that conflict with these terms, the warranty terms in the separate agreement will control.

Exclusive Remedies

The remedies provided herein are Buyer's sole and exclusive remedies. Agilent Technologies shall not be liable for any direct, indirect, special, incidental, or consequential damages, whether based on contract, tort, or any other legal theory.

Assistance

Product maintenance agreements and other customer assistance agreements are available for Agilent Technologies products.

For any assistance, contact your nearest Agilent Technologies Sales and Service Office. Addresses are provided at the back of this manual.

Typeface Conventions

Sample (bold)

Boldface type is used when a term is defined or emphasis.

Sample (Italic)

Italic type is used for emphasis.

Sample key

Indicates a hardkey (key on the front panel or external keyboard) labeled “Sample.” “key” may be omitted.

Sample menu/button/box

Indicates a menu/button/box on the screen labeled “Sample” which can be selected/executed by clicking. “menu,” “button,” or “box” may be omitted.

Sample block/toolbar

Indicates a block (group of hardkeys) or a toolbar (setup toolbar) labeled “Sample.”

Sample 1 - Sample 2 - Sample 3

Indicates a sequential operation of **Sample 1**, **Sample 2**, and **Sample 3** (menu, button, or box). “-” may be omitted.

Documentation Map

The following manuals are available for the Agilent E5070B/E5071B.

- ***User's Guide (Part Number E5070-904x0, attached to Option ABA)***

This manual describes most of the basic information needed to use the E5070B/E5071B. It provides a function overview, detailed operation procedure for each function (from preparation for measurement to analysis of measurement results), measurement examples, specifications, and supplemental information. For programming guidance on performing automatic measurement with the E5070B/E5071B, please see the *Programming Manual*.
- ***Installation and Quick Start Guide (Part Number E5070-900x1, attached to Option ABA)***

This manual describes installation of the instrument after it is delivered and the basic procedures for applications and analysis. Refer to this manual when you use the E5070B/E5071B for the first time.
- ***Programmer's Guide (Part Number E5070-900x2, attached to Option ABA)***

This manual provides programming information for performing automatic measurement with the E5070B/E5071B. It includes an outline of remote control, procedures for detecting measurement start (trigger) and end (sweep end), application programming examples, a command reference, and related information.
- ***VBA Programmer's Guide (Part Number E5070-900x3, attached to Option ABA)***

This manual describes programming information for performing automatic measurement with internal controller. It includes an outline of VBA programming, some sample programming examples, a COM object reference, and related information.

NOTE

The number position shown by “x” in the part numbers above indicates the edition number. This convention is applied to each manual, CD-ROM (for manuals), and sample programs disk issued.

VBA Macro

The Agilent folder (D:\Agilent) on the hard disk of the E5070B/E5071B contains the VBA macros (VBA Projects) used in this manual.

The customer shall have the personal, non-transferable rights to use, copy, or modify the VBA macros for the customer's internal operations.

The customer shall use the VBA macros solely and exclusively for their own purposes and shall not license, lease, market, or distribute the VBA macros or modification of any part thereof.

Agilent Technologies shall not be liable for any infringement of any patent, trademark, copyright, or other proprietary right by the VBA macros or their use. Agilent Technologies does not warrant that the VBA macros are free from infringements of such rights of third parties. However, Agilent Technologies will not knowingly infringe or deliver software that infringes the patent, trademark, copyright, or other proprietary right of a third party.

1. Precautions	
Software Installed	26
Before contacting us	27
2. Overview of Functions	
Front Panel: Names and Functions of Parts	30
1. Standby Switch	31
2. LCD Screen	31
3. ACTIVE CH/TRACE Block	32
4. RESPONSE Block	33
5. STIMULUS Block	34
6. Floppy Disk Drive	34
7. NAVIGATION Block	35
8. ENTRY Block	36
9. INSTR STATE Block	37
10. MKR/ANALYSIS Block	38
⚠ 11. Test Port	38
12. Front USB Port	39
13. Ground Terminal	39
Screen Area: Names and Functions of Parts	40
1. Menu Bar	40
2. Data Entry Bar	40
3. Softkey Menu Bar	42
4. Instrument Status Bar	44
5. Channel Window	46
Rear Panel: Names and Functions of Parts	54
1. Handler I/O Port	55
2. Ethernet Port	55
3. External Monitor Output Terminal (Video)	55
4. GPIB Connector	55
5. External Trigger Input Connector (Ext Trig)	55
6. Fan	55
7. Line Switch (Always ON)	55
8. Power Cable Receptacle (to LINE)	56
9. High Stability Frequency Reference Output Connector (Ref Oven, Option 1E5 only)	56
10. External Reference Signal Input Connector (Ref In)	56
11. Internal Reference Signal Output Connector (Ref Out)	57
12. Serial Number Plate	57
13. Certificate of Authenticity Label	57
14. Rear USB port	57
15. Reserved Port (Reserved)	57
16. Printer Parallel Port	57
17. Mini-DIN Keyboard Port	57
18. Mini-DIN Mouse Port	58
19. USB (USBTMC) Interface Port	58
3. Setting Measurement Conditions	
Initializing Parameters	60

Contents

Setting Channels and Traces	61
Setting upper limits of number of channels/traces	61
Setting channel display (layout of channel windows)	62
Setting trace display	64
Active channel	66
Active trace	66
Parameter setting for each setup item (analyzer, channel, trace)	67
Setting the System Z0	69
Setting Stimulus Conditions	70
Setting sweep type	70
Setting the Sweep Range	70
Turning stimulus signal output on/off	73
Setting fixed frequency at power sweep	73
Setting power level with Auto Power Range set function	74
Setting power range manually	77
Setting the number of points	78
Setting the sweep time	78
Selecting Measurement Parameters	80
Definition of S-parameters	80
Setting up S-parameters	80
Selecting a Data Format	81
Rectangular display formats	81
Polar format	82
Smith chart format	83
Selecting a data format	84
Setting the Scales	85
Auto scale	85
Manual scale adjustment on a rectangular display format	85
Manual scale adjustment on the Smith chart/polar format	87
Setting the value of a reference line using the marker	87
Setting Window Displays	88
Maximizing the specified window/trace display	88
Turning off the display of graticule labels	88
Hiding Frequency Information	89
Labeling a window	89
Setting display colors	91
4. Calibration	
Measurement Errors and their Characteristics	94
Drift Errors	94
Random Errors	94
Systematic Errors	95
Calibration Types and Characteristics	99
Checking Calibration Status	102
Execution status of error correction for each channel	102
Execution status of error correction for each trace	102
Acquisition status of calibration coefficient for each channel	103
Selecting Calibration Kit	105
Setting the trigger source for calibration	106

OPEN/SHORT Response Calibration (reflection test)	107
Procedure.	107
THRU Response Calibration (transmission test)	110
Procedure.	110
1-Port Calibration (reflection test)	113
Procedure.	114
Enhanced Response Calibration	115
Procedure.	116
Full 2-Port Calibration	118
Procedure.	119
Full 3-Port Calibration	121
Procedure.	122
Full 4-Port Calibration	124
Procedure.	125
ECal (electronic calibration).	127
1-Port Calibration Using a 2-Port ECal Module	127
Full 2-Port Calibration Using the 2-Port ECal Module.	128
Unknown Thru Calibration	130
Turning off ECal auto-detect function	131
Full 3-Port and Full 4-Port Calibration using 2-Port ECal	132
Operational procedure.	132
Calibration Using 4-port ECal	135
Operational procedure.	135
2-port TRL calibration	137
Operational procedure.	138
3-port TRL calibration	140
Operational procedure.	141
4-port TRL calibration	144
Operational procedure.	145
Simplified calibration	148
Simplified full 3/4-port calibration	148
Simplified 3/4-port TRL calibration	149
Partial overwrite	151
Procedure.	151
Improving accuracy of measurement using partial overwrite (thru calibration) along with ECal	152
Unknown Thru Calibration.	153
Procedure.	153
Calibration between Ports of Different Connector Types	155
Operating procedure	156
Adapter Characterization	160
Concept	161
How to execute adapter characterization	162
Execution procedure of characterization for test fixture using probe	165
Adapter Removal-Insertion.	167
About Adapter Removal	167
About Adapter Insertion	169
Procedure for Adapter Removal / Insertion	170
User-characterized ECal	171
Precautions to take in using VBA macros.	171

Storing user characteristics to the ECal module	172
Backup and recovery of ECal module's built-in flash memory	176
Executing User-characterized ECal	177
Confidence Check on Calibration Coefficients Using ECal	179
Operational procedure.	179
Changing the Calibration Kit Definition	181
Definitions of terms	182
Defining parameters for standards	183
Redefining a calibration kit.	185
Example of defining the TRL calibration kit	188
Setting options for TRL calibration	190
Setting a media type for the calibration kit.	191
Saving and loading definition file of calibration kit.	192
Default settings of pre-defined calibration kits.	193
Specifying Different Standard for Each Frequency	202
Defining different standard for each frequency band.	202
Defining standard for each subclass	203
Disabling standard defined for a subclass.	204
Notes on how frequency ranges are dealt when using subclasses	205
Power Calibration.	208
Turning ON or OFF power level error correction.	208
Preparing power meter and sensor	209
Selecting target port of error correction	215
Setting loss compensation.	215
Setting a tolerance for power calibration	218
Measuring calibration data	218
Receiver Calibration.	220
Turning ON/OFF receiver error correction.	220
Selecting target port for error correction	221
Measuring the calibration data	221
Vector-Mixer Calibration	223
Overview of vector-mixer calibration.	223
Measured mixer	224
Calibration mixer (with IF filter)	224
Characterizing calibration mixer (with IF filter)	224
Characterizing procedure for calibration mixer (with IF filter)	225
How to execute characterization of calibration mixer	226
Characterizing calibration mixer (with IF filter) for balance mixer measurement.	230
How to execute characterization.	230
Scalar-Mixer Calibration	233
Confirming calibration status	234
Operational Procedure (when using mechanical calibration kit)	235
Operational procedure (when using ECal module).	238
5. Making Measurements	
Setting Up the Trigger and Making Measurements	242
Sweep Order in Each Channel	242
Trigger Source.	243
Trigger Modes.	243

Setting Up the Trigger and Making Measurements	243
Setting the Point Trigger	245
Procedure to Set the Point Trigger	245
Setting the low-latency external trigger mode	246
Procedure to set the low-latency external trigger	246
External trigger delay time and point trigger interval	247
Setting the Averaging Trigger Function	249
Using the averaging trigger function	249
Executing a Trigger Only for Active Channel	250
Procedure to set the range	250
6. Data Analysis	
Analyzing Data on the Trace Using the Marker	252
About marker functions	252
Reading values on the trace	253
Reading the Relative Value From the Reference Point on the Trace	256
Reading only the actual measurement point/Reading the value interpolated between measurement points	257
Setting up markers for each trace/Setting up markers for coupled operations between traces	258
Listing all marker values in all channels displayed	259
Specifying the display position of marker values	260
Aligning maker value displays	261
Displaying all marker values for displayed traces	262
Searching for Positions that Match Specified Criteria	263
Setting search range	263
Automatically executing a search each time a sweep is done (search tracking)	264
Searching for the maximum and minimum measured values	265
Searching for the target value (target search)	266
Searching for the peak	268
Determining the Bandwidth of the Trace (Bandwidth Search)	270
Executing a Bandwidth Search	270
Determining the Mean, Standard Deviation, and p-p of the Trace	272
Displaying Statistics Data	272
Comparing Traces/Performing Data Math	273
Performing Data Math Operations	273
Performing Parameter Conversion of Measurement Results	275
Operational Procedure	275
Using the Equation Editor	277
Procedure to start the equation editor	277
Procedure to use the equation editor	277
Enabling/Disabling the equation editor	279
Entering the equation label	279
7. Fixture Simulator	
Overview of Fixture Simulator	282
Functions for single-ended (unbalanced) port	283
Balance-unbalance conversion (option 313, 314, 413, or 414)	284
Functions for balanced port (option 313, 314, 413, or 414)	284

Extending the Calibration Plane Using Network De-embedding	285
Using the Network De-embedding Function	285
Converting the Port Impedance of the Measurement Result	286
Converting the Port Impedance	286
Determining Characteristics After Adding a Matching Circuit	287
Using the Matching Circuit Function	287
Obtaining Characteristics After Embedding/De-embedding 4-port Network	290
Operational Procedure	291
Evaluating Balanced Devices (balance-unbalance conversion function).	293
Measurement parameters of balanced devices	295
Steps for Balance-Unbalance Conversion	298
Steps for Measurement Parameter Setups.	299
Checking device type and port assignment.	299
Converting Reference Impedance of Balanced Port	300
Converting port reference impedance in differential mode	301
Converting port reference impedance in common mode	301
Determining the Characteristics that Result from Adding a Matching Circuit to a Differential Port	303
Example of Using Fixture Simulator	306
Measurement circuit example for a DUT with balanced port	306
Evaluation using an actual test fixture	306
Problems in measurement with an actual test fixture	307
DUT evaluation using the E5070B/E5071B's fixture simulator	308
Advantages of balanced DUT evaluation using fixture simulator	310
8. Frequency-Offset Measurement (Option 008)	
Overview	312
Overview of Frequency-Offset Measurement	312
Measurement of Mixers	313
Measurement flow	313
1. Setting Frequency-Offset	313
2. Setting External Signal Source	316
3. Avoid Spurious Function	320
4. Changing Frequency Data	321
5. Implementing Mixer Calibration	323
6. Conversion Loss Measurement.	323
Measurement of Harmonic Distortion	326
Measurement flow	326
1. Setting Frequency-Offset Function.	326
2. Implementing Receiver Calibration	327
3. Setting Absolute Measurement Parameters	327
4. Harmonic Distortion Measurement	328
9. Analysis in Time Domain (Option 010)	
Overview	332
Overview of time domain measurement.	332
Comparison to time domain reflectometry (TDR) measurement	332
Time domain function of E5070B/E5071B	333
Transformation to time domain	334

Measurement flow	334
Selecting a type	335
Setting the window	337
Calculating necessary measurement conditions	338
Setting the frequency range and the number of points	342
Setting display range	343
Enabling transformation function	343
Deleting Unnecessary Data in Time Domain (gating)	345
Measurement Flow	345
Setting gate type	345
Setting gate shape	346
Setting gate range	347
Enabling gating function	348
Characteristics of Response in Time Domain	349
Masking	349
Identifying mismatch type	350
10. Data Output	
Saving and Recalling Instrument State	352
Compatibility of files related to saving and recalling	352
Save procedure	354
Recall Procedure	357
Recall Procedure Using “Recall by File Name” Feature	358
Priority of recalling the configuration file at startup	358
Saving/Recalling Instrument State for Each Channel into/from Memory	359
Operational Procedure	359
Saving Trace Data to a File	360
Saving data as a CSV file	360
Saving data in Touchstone format	361
Saving the Screen Image to a File	366
Saving the Screen Image to a File	366
Organizing Files and Folders	367
To Open Windows Explorer	367
To Copy a File or Folder	367
To Move a File or Folder	368
To Delete a File or Folder	368
To Rename a File or Folder	368
To Format a Floppy Disk	368
Printing Displayed Screen	369
Supported printers	369
Printed/saved images	370
Print Procedure	370
11. Limit Test	
Limit Test	374
Concept of limit test	374
Displaying judgment result of limit test	375
Defining the limit line	376

Turning the limit test ON/OFF	380
Limit line offset.	381
Initializing the limit table	382
Ripple Test	383
Concept of ripple test	383
Displaying ripple test results.	384
Configuring ripple limit	385
Turning on/off ripple test and displaying results	388
Initializing the limit table	389
Bandwidth Test.	390
Displaying Bandwidth Test Results	391
Set up bandwidth test	392
Turning On/Off Bandwidth Test and Displaying Results.	392
12. Optimizing Measurements	
Expanding the Dynamic Range	394
Lowering the receiver noise floor.	394
Reducing Trace Noise	396
Turning on Smoothing	396
Improving Phase Measurement Accuracy	398
Electrical Delay.	398
Phase offset.	400
Specifying the velocity factor.	400
Setting Port Extensions and Loss Values	401
Setting port extensions	401
Setting loss values.	402
Enabling port extensions and loss values	403
Using the auto port extension function.	404
Reducing Measurement Error in High Temperature Environments.	409
Procedure	409
Improving Measurement Throughput.	410
Using Fast Sweep Modes	410
Turning off the updating of information displayed on the LCD screen	414
Turning off system error correction	414
Performing a Segment-by-Segment Sweep (segment sweep)	415
Concept of Segment Sweep	415
Conditions for setting up a segment sweep	416
Items that can be set for each segment	416
Sweep delay time and sweep time in a segment sweep	417
Frequency base display and order base display	417
Procedure	419
13. Setting and Using the Control and Management Functions	
Setting the GPIB.	426
Setting talker/listener GPIB address of E5070B/E5071B	426
Setting system controller (USB/GPIB interface)	426
Setting the Internal Clock.	429
Setting the Date and Time.	429

Setting the Date/Time Display ON/OFF	430
Setting the Mouse	431
Setup Step	431
Configuring the Network	434
Enabling/disabling network.	434
Setting IP address	435
Specifying computer name	437
Remote Control Using HTTP	439
Required Modification of Settings	439
How to Start VNC Server Configuration	439
Accessing Hard Disk of E5070B/E5071B from External PC.	440
Enabling the access form the external PC.	440
Accessing hard disk of E5070B/E5071B from external PC	442
Disabling USB Mass Storage Device	443
Steps for Setting Modification	443
Locking the Front Keys, Keyboard, and/or Mouse (Touch Screen).	444
Locking the Front Keys, Keyboard, and/or Mouse.	444
Setting the Beeper (Built-in Speaker).	445
Setting the Operation Complete Beeper	445
Setting the Warning Beeper.	445
Turning off the LCD Screen Backlight.	446
Turning off the LCD Screen Backlight	446
Checking the product information	447
Checking the serial number.	447
Checking other product information	447
Setting the preset function	449
Showing/hiding the confirmation buttons when presetting.	449
Setting the user preset function	449
Saving a user-preset instrument state	450
System Recovery	451
Types of system recoveries	451
Notes on executing system recovery	451
Procedure to execute the factory function (1).	452
Procedure to create the user backup image (1)	455
Procedure to execute the user recovery function (1).	458
Procedure to execute the factory recovery function (2)	461
Procedure to create the user backup image (2)	464
Procedure to execute the user recovery function (2).	467
Calibration of the Touch Screen	470
Initial Source Port Control function	471
14. Controlling E5091A	
Connecting E5070B/E5071B and E5091A.	474
Required devices	474
Connecting E5070B/E5071B and E5091A.	474
Powering on.	475
Setting the E5091A.	476
Selecting ID for E5091A.	476
Selecting the E5091A Model	477

Assigning test ports	477
Displaying the E5091A properties	479
Setting control line	480
Enabling control of E5091A	481
Calibration	482
Performing Measurement	483
Trigger state and switching the setting of the E5091A	483
Operation	483
Connecting Two E5091As	484

15. Measurement Examples

Measuring the SAW Bandpass Filter Using the Segment Sweep	486
Evaluation Steps	486
1. Determine the Segment Sweep Conditions	487
2. Create a Segment Sweep Table	488
3. Select the Segment Sweep as the Sweep Type	490
4. Execute the Calibration	490
5. Connect the DUT	491
6. Execute the Measurement	491
7. Define the Setup for Display	491
Evaluating a Duplexer	493
Evaluation Steps	493
1. Determine the Segment Sweep Conditions	493
2. Create a Segment Sweep Table	494
3. Select the Segment Sweep as the Sweep Type	495
4. Execute the Calibration	495
5. Connect the DUT	497
6. Define the Setup for Display	498
7. Execute the Measurement	498
8. Define the Setup for the Segment Display and Scale	498
9. Analyze the Parameters	499
10. Define the Setup for a Limit Table	501
11. Execute the Limit Test	502
Measuring the Deviation from a Linear Phase	505
Evaluation Steps	505
1. Connect the DUT	505
2. Define the Measurement Conditions	506
3. Execute the Calibration	506
4. Connect the DUT and Execute the Auto Scale	506
5. Specify the Electrical Delay	507
6. Measure the Deviation from a Linear Phase	508
Measuring an Unbalanced and Balanced Bandpass Filter	509
Evaluation Steps	509
1. Connecting the DUT	510
2. Setting the Measurement Conditions	511
3. Performing Calibration	512
4. Setting a Balance Conversion Topology	513
5. Selecting Measurement Parameters	513
6. Extending the Calibration Plane (removing the cause of error)	515

7. Setting the Port Reference Impedances	515
8. Adding a Matching Circuit	517
Measuring Parameters with Cable	518
Overview of evaluation procedure	518
1. Setting the Measurement Conditions	518
2. Executing Calibration	518
3. Connecting the DUT	519
4. Auto Scale	519
5. Setting the Time Domain Function	520
Evaluating Transmission Characteristics of a Front End Module	521
Overview of evaluation procedure	521
1. Determining Measurement Conditions	522
2. Setting Channel Window Allocation	522
3. Setting the Test Ports	522
4. Setting Control Line	523
5. Setting Sweep Conditions	523
6. Setting Balance Conversion Topology	523
7. Selecting Measurement Parameter	524
8. Executing Calibration	524
9. Connecting DUT	526
10. Executing Measurement	527
Executing Power Calibration	529
Overview of execution procedure	529
1. Connecting Power Meter	529
2. Setting Address of Power Meter	530
3. Setting Stimulus Condition	530
4. Executing Zero Adjustment and Calibration of Power Sensor	530
5. Setting Calibration Data Measurement Conditions	530
6. Connecting Power Sensor	531
7. Measuring Calibration Data	531
16. Specifications and Supplemental Information	
Definitions	534
Corrected System Performance	535
Uncorrected System Performance	540
Test Port Output (Source)	541
Test Port Input	543
General Information	547
Measurement Throughput Summary	555
Measurement capabilities	558
Source control	559
Trace functions	559
Data accuracy enhancement	560
Storage	561
System capabilities	561
Automation	562
17. Measurement Accessories	

Contents

Test Port Cables	564
N6314A 50 Ω N Type RF Cable (300 kHz ~ 9 GHz)	564
N6315A 50 Ω N Type RF Cable (300 kHz ~ 9 GHz)	564
Calibration Kits	565
For Devices with N Type Connectors	565
For Devices with 3.5 mm (SMA) Connectors	568
For Devices with 7 mm Connectors	571
For Devices with 7-16 Connectors	572
Adaptors	573
11853A 50 Ω N Type Accessory Kit	573
11878A N type to 3.5 mm Adaptor Kit	573
11854A 50 Ω BNC Accessory Kit	573
11852B Minimum-loss pad	573
System Accessories	574
System Racks and Cases	574
GP-IB Cables	574
82357A USB/GPIB Interface	574
18. Information on Maintenance	
Backing Up the Data	576
Making Backup Files	576
Removing/Mounting Removable Hard Disk	577
Removing Removable Hard Disk	577
Mounting Removable Hard Disk	577
Writing System Correction Data from Backup Memory to Removable Hard Disk	579
Cleaning this Instrument	580
Cleaning an LCD	580
Maintenance of Test Ports and Other Connectors/Ports	580
Cleaning a Display Other than an LCD	580
Replacement of Parts with Limited Service Life	581
Cautions Applicable to Requesting Repair, Replacement, Regular Calibration, etc.	582
Backing Up Data in the Hard Disk	582
Devices to be Sent Back for Repair or Regular Calibration	582
Recommended Calibration Period	582
A. Manual Changes	
Manual Changes	584
Change 14	585
Change 13	585
Change 12	585
Change 11	595
Change 10	599
Change 9	600
Change 8	601
Change 7	601
Change 6	602
Change 5	602
Change 4	605

Change 3	605
Change 2	605
Change 1	605
B. Troubleshooting	
Troubleshooting	608
Troubleshooting during Startup	608
Troubleshooting during Operation	609
Troubleshooting for External Devices	612
Error Messages	613
A	613
B	613
C	613
D	614
E	614
F	615
G	616
H	616
I	616
L	618
M	618
N	618
O	619
P	619
Q	621
R	621
S	622
T	623
U	624
V	624
Warning Message	626
C. List of Default Values	
List of Default Values, Save/Recall Settings, and Backup Settings	630
D. Softkey Functions	
E5070B/E5071B Menu (Top Menu)	646
Analysis Menu	647
Average Menu	662
Calibration Menu	663
Display Menu	688
Format Menu	692
Macro Setup Menu	693
Marker Menu	695
Marker Function Menu	697
Marker Search Menu	698
Measurement Menu	701
Measurement Menu (Balance Measurement, SE-Bal)	703

Measurement Menu (Balanced Measurement, Bal-Bal)	704
Measurement Menu (Balanced Measurement, SE-SE-Bal)	706
Preset Menu	708
Save/Recall Menu.	709
Scale Menu	713
Stimulus Menu	714
Sweep Setup Menu.	715
System Menu	718
Trigger Menu	725
E. General Principles of Operation	
System Description.	728
Synthesized Source	728
Source Switcher	729
Signal Separator	729
Receiver	729
Data Processing	730
ADC	730
Digital Filter	730
IF Range Correction	731
Ratio Calculation	731
Port Characteristics Correction.	731
Sweep Averaging	731
Raw Data Array	731
Error Correction/Calibration Coefficient Data Array.	731
Port Extension.	731
Fixture Simulator	731
Corrected Data Array	732
Corrected Memory Array	732
Equation Editor	732
Data Math	732
Electrical Delay/Phase Offset.	732
Data Format/Group Delay	732
Smoothing	732
Formatted Data Array/Formatted Memory Array	732
Offset/Scale.	732
Display	733
F. Replacing the 8753ES with the E5070B/E5071B	
Important Functional Differences.	736
Channel and Trace Concepts.	736
Measurement Parameters	736
Test Port Output Ranges	736
Sweep Function.	737
Calibration	738
Trigger System	739
Data Flow	740
Reading/Writing Data.	741

Screen Display and Marker Functions	742
Math Operation Functions on Traces	742
Device Test Functions	742
Analytical Functions	743
Save/Recall	744
Test Sequence Program	744
Outputting to a Printer/Plotter	744
GPIB Interface	744
LAN Interface	744
Other Functions	744
Comparing Functions	745

1 Precautions

This chapter describes cautions that must be observed in operating the E5070B/E5071B.

Software Installed

The Windows operating system installed in this machine is customized for more effective operation, and has different functions that are not part of the Windows operating system for ordinary PCs (personal computers).

Therefore, do not attempt to use the system in ways other than those described in this manual or to install Windows-based software (including anti-virus software) for ordinary PCs as doing so may cause malfunctions.

Also note the followings.

- Do not update the Windows operating system installed in this machine to the Windows operating system for ordinary PCs. Doing so will cause malfunctions.
- Do not attempt to update VBA (Visual Basic for Applications) software installed in this machine to its equivalent developed for ordinary PCs. Doing so will cause malfunctions.
- Do not allow any computer virus to infect the system. This machine has no virus check function nor anti-virus software installed.

Agilent Technologies will not be held liable for any failure or damage arising from negligence regarding these prohibitions and warnings.

NOTE

If the pre-installed software is damaged somehow, resulting in errant behavior by the machine, perform a system recovery. For further details of system recovery, refer to “System Recovery” on page 451.

Before contacting us

If you encounter the following problems during startup or operation of the E5070B/E5071B, in which initial registration of the Windows 2000 Operating System has been properly performed, execute system recovery and update the firmware version. As for the system recovery procedure, refer to “System Recovery” on page 451.

The system starts up, but the normal measurement screen does not appear

- The system automatically shuts down immediately after the startup, or the startup process stops.
- The measurement screen appears, but "Power on test fail" or "Calibration data lost" is displayed in the instrument message/warning area against a red background in the lower-left part of the screen. The system enters the service mode. (The instrument status bar in the lower-right displays SVC in red).

Unstable Operation

- The system hangs up while the instrument is controlled from VBA or external PCs.
- The blue screen appears and the system hangs up.
- The response is much slower than usual.

When execution of system recovery does not result in normal operation, a failure may have occurred. Contact Agilent Technology’s Customer Contact listed at the end of this guide or the company from which you bought the device.

For other problems, refer to “Troubleshooting” on page 608.

Precautions
Before contacting us

2

Overview of Functions

This chapter describes the functions of the E5070B/E5071B that can be accessed from the front panel, LCD screen, and rear panel.

Front Panel: Names and Functions of Parts

This section describes the names and functions of the parts on the front panel of the E5070B/E5071B. For more details on the functions displayed on the LCD screen, see “Screen Area: Names and Functions of Parts” on page 40. For more about the functions of softkeys, see Appendix D, “Softkey Functions,” on page 645.

Figure 2-1 Front panel

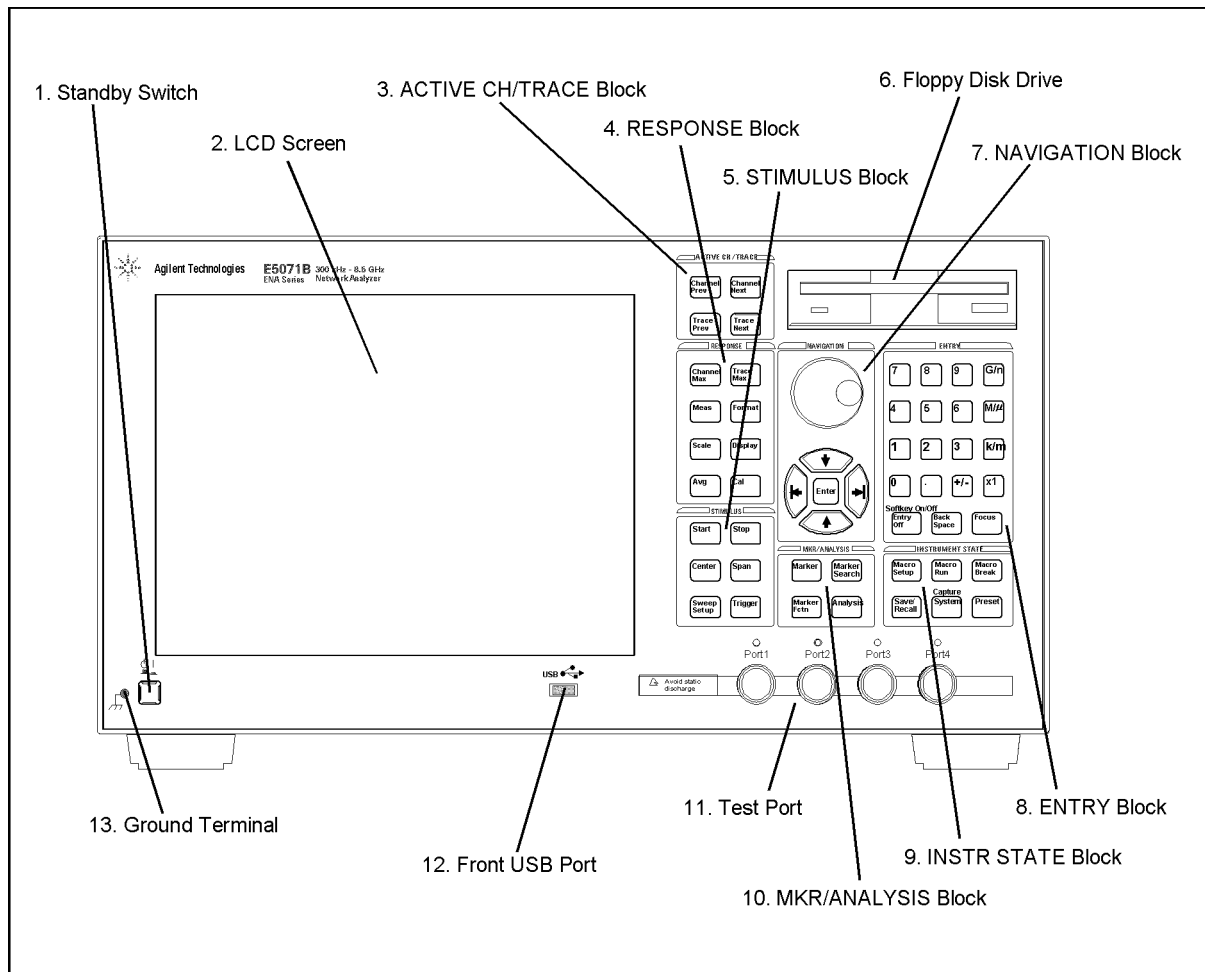

e5070bue032

1. Standby Switch

Used for choosing between power-on (|) and standby (⏻) states of the E5070B/E5071B.

NOTE

To turn off the power for the E5070B/E5071B, be sure to follow the steps described below.

1. First, press this standby switch or send a shutdown command from the external controller to activate the shutdown process (the processing of software and hardware necessary to turn off the power supply). This will put the E5070B/E5071B into the standby state.
2. Next, if necessary, turn off the power supply to the “8. Power Cable Receptacle (to LINE)” on page 56 on the rear panel.

Under normal use, never directly interrupt the power supply to the power cable receptacle on the rear panel when the power supply is on. Always keep the “7. Line Switch (Always ON)” on page 55 at (|). Never turn it off (⏻).

If you directly interrupt the power supply to the power cable receptacle when the power supply is on, or turn off the “7. Line Switch (Always ON)” on page 55, the shutdown process will not work. This could damage the software and hardware of the E5070B/E5071B and lead to device failure.

Turning on the power supply after a faulty shutdown may cause the system to start up in a condition called “safe mode.” If this occurs, first shut down the system to put it into the standby state and then turn on the power supply again to start up the system in normal mode.

For more about turning the power supply on/off and putting it into the standby state, see Chapter 1 “Installation Guide” in the *Installation and Quick Start Guide*.

2. LCD Screen

A 10.4-inch TFT color LCD used for displaying traces, scales, settings, softkeys, etc. Either a standard color LCD or a touch screen color LCD (Option 016) is supplied. The touch screen LCD allows you to manipulate softkeys by touching the LCD screen directly with a finger. For more on the LCD screen, see “Screen Area: Names and Functions of Parts” on page 40.

NOTE

Do not press the surface of the LCD screen (either standard or touch screen type) with a sharp object (e.g., a nail, pen, or screwdriver). Pressing the surface with a sharp-pointed object will damage the LCD screen surface or cause the screen to fail. Be especially careful when using a touch screen LCD.

NOTE

Occasionally, a few pixels may appear on the screen as a fixed point of blue, green or red. Please note that this is not a failure and does not affect the performance of your product.

3. ACTIVE CH/TRACE Block

A group of keys for selecting active channels and traces. For more on the concepts of channels and traces, see “Setting Channels and Traces” on page 61.

Channel Next Key

Selects the next channel as the active channel. (Each time the key is pressed causes the active channel to step up from the channel with the currently designated number to one with a larger channel number.) A channel must be active before you can define such parameters as the sweep range. To change the settings for a channel, use this key to first make the channel active.

Channel Prev Key

Selects the previous channel as the active channel. (Each time the key is pressed causes the active channel to step down from the channel with the currently designated number to one with a smaller channel number.)

Trace Next Key

Selects the next trace as the active trace. (Each time the key is pressed causes the active trace to step up from the trace with the currently designated number to one with a larger channel number.) A trace must be active before you can define measurement parameters and other settings. To change the settings for a trace, use this key to first make the trace active.

Trace Prev Key

Selects the previous trace as the active trace. (Each time the key is pressed causes the active trace to step down from the trace with the currently designated number to one with a smaller trace number.)









4. RESPONSE Block

A group of keys used mainly for setting up response measurements on the E5070B/E5071B.

Channel Max Key	Changes between normal and maximum display of the active channel window. In normal display, all of the defined channel windows (both active and non-active) are displayed in split views on the screen. In maximum display, only the active channel window is displayed over the entire area, with non-active windows not displayed. To maximize the active channel, double-click the channel window frame. Measurements are also carried out on the non-active channels that are not displayed.
Trace Max Key	Changes between normal and maximum display of the active trace. In normal display, all of the traces defined on the channel (both active and non-active) are displayed on the screen. In maximum display, only the active trace is displayed over the entire area, with non-active traces not displayed. To maximize the active trace, double-click the area inside the channel window (excluding the frame). Measurements are also carried out on the non-active traces not displayed.
Meas Key	Displays the “Measurement Menu” on page 701 on the right side of the screen. Manipulating the “Measurement Menu” enables you to specify the measurement parameters (types of S-parameters) for each trace.
Format Key	Displays the “Format Menu” on page 692 on the right side of the screen. Manipulating the “Format Menu” enables you to specify the data format (data transformation and graph formats) for each trace.
Scale Key	Displays the “Scale Menu” on page 713 on the right side of the screen. Manipulating the “Scale Menu” enables you to specify the scale for displaying a trace (magnitude per division, value of the reference line, etc.) for each trace. You can also specify the electrical delay and phase offset for each trace.
Display Key	Displays the “Display Menu” on page 688 on the right side of the screen. Manipulating the “Display Menu” enables you to specify the number of channels and the channel window array, the number and arrangement of traces, the setup for data math, etc.
Avg Key	Displays the “Average Menu” on page 662 on the right side of the screen. Manipulating the “Average Menu” enables you to define the averaging, smoothing, and IF bandwidth.
Cal Key	Displays the “Calibration Menu” on page 663 on the right side of the screen. Manipulating the “Calibration Menu” enables you to turn the calibration and error correction on/off and change definitions for calibration kits.

5. STIMULUS Block

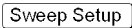
A group of keys for defining the stimulus values (signal sources and triggers).

 Key	Displays the data entry bar for specifying the start value of the sweep range in the upper part of the screen. (It also displays the “Stimulus Menu” on page 714 for specifying the sweep range on the right side of the screen.)
 Key	Displays the data entry bar for specifying the stop value of the sweep range in the upper part of the screen. (It also displays the “Stimulus Menu” in the same way as  .)
 Key	Displays the data entry bar for specifying the center value of the sweep range in the upper part of the screen. (It also displays the “Stimulus Menu” in the same way as  .)
 Key	Displays the data entry bar for specifying the span value of the sweep range in the upper part of the screen. (It also displays the “Stimulus Menu” in the same way as  .)
 Key	Displays the “Sweep Setup Menu” on page 715 on the right side of the screen. Manipulating the “Sweep Setup Menu” enables you to specify the signal source power level, sweep time, number of points, sweep type, etc.
 Key	Displays the “Trigger Menu” on page 725 on the right side of the screen. Manipulating the “Trigger Menu” enables you to specify the trigger mode and trigger source. You can specify the trigger mode for each channel.

6. Floppy Disk Drive

A device for storing to and reading from a floppy disk the setup state of the E5070B/E5071B, measurement data, calibration data, data on images displayed on the LCD screen, VBA (Visual Basic for Applications) programs, etc. The floppy disk drive is compatible with a 3.5-inch, 1.44 MB, DOS (Disk Operating System) formatted floppy disk.

There is a floppy disk access lamp to the lower left of the floppy disk drive opening. When the floppy disk drive is accessing a disk (for reading or writing), this lamp is lit green.

Pressing the disk eject button to the lower right of the floppy disk drive ejects the inserted floppy disk.

NOTE

Insert a floppy disk into the floppy disk drive opening **right side up** in the direction of the arrow marked on the disk.

Do not press the disk eject button while the floppy disk access lamp is on. Trying to forcefully pull the floppy disk out while the lamp is on may damage the floppy disk or disk drive.



7. NAVIGATION Block

The keys and knob in the NAVIGATION block are used to navigate between softkey menus, tables (limit table, segment table, etc.), or selected (highlighted) areas in a dialog box as well as to change a numeric value in the data entry area by stepping up or down. When selecting one of two or more objects (softkey menus, data entry areas, etc.) to manipulate with the NAVIGATION block keys displayed on the screen, first press the **Focus** key in the “8. ENTRY Block” on page 36 to select the object to be manipulated (placing focus on the object) and then manipulate the NAVIGATION block keys (knob) to move among selected (highlighted) objects or change numeric values.

The following descriptions show how the NAVIGATION block keys work both when the focus is on a softkey menu and when the focus is on the data entry area. For more on manipulating tables and dialog boxes, refer to the manipulation procedure for each of these functions.

When the focus is on a softkey menu (softkey menu is selected)

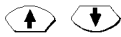

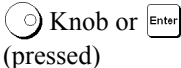
When the focus is placed on a softkey menu (the menu title area in the uppermost part is displayed in blue), the NAVIGATION block keys work as described below.

-  Knob
(turned clockwise or counterclockwise) Moves the softkey selection (highlighted display) up or down.
-  Keys Moves the softkey selection (highlighted display) up or down.
-  Key Displays the softkey menu one layer above.
-  Key Displays the softkey menu one layer below.
-  Knob or **Enter** key
(pressed) Executes the function of the selected softkey.

After pressing the data entry softkey, the focus automatically moves to the data entry area.



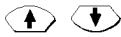

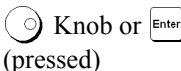
When the focus is on the data entry area (data entry area is selected)

When the focus is placed on the data entry area (the data entry bar is displayed in blue), the NAVIGATION block keys work as described below.

-  Knob
(turned clockwise or counterclockwise) Increases or decreases the numeric value in the data entry area in small steps.
-  Keys Increases or decreases the numeric value in the data entry area in large steps.
-  Keys Moves the cursor (|) in the data entry area laterally back and forth. Use it together with the “8. ENTRY Block” keys to change data one character at a time.
-  Knob or **Enter** key
(pressed) Finishes the entry in the data entry area and moves the focus to the softkey menu.

8. ENTRY Block

A group of keys used for entering numeric data.





   ...  

Keys (numeric keys)



Type numeric characters or a decimal point at the position of the cursor in the data entry area.

 Key

Alternately changes the sign (+, -) of a numeric value in the data entry area.

   

Keys

Adds a prefix to the numeric data typed by using the numeric key and  and then enters that data. One of the two prefixes written on the surface of the key is automatically selected depending on the parameter to be entered.  is entered without a prefix.

Softkey On/Off
 Key

Turns off the data entry bar if it is displayed. If the dialog box is displayed, cancels the entry and closes the dialog box. If the data entry bar and dialog box are not displayed, turns the softkey menu display on/off.

 Key





Deletes a character to the left of the cursor (|) in the data entry area. When two or more characters in the data entry area are selected (highlighted), deletes all of the characters selected.

 Key

Changes the selection (focus) among the objects to be manipulated by the NAVIGATION block keys and ENTRY block keys. The objects to be manipulated by the NAVIGATION block keys and ENTRY block keys include softkey menus, data entry areas, tables (e.g., segment tables, limit tables, and marker tables), and dialog boxes. When two or more of these are displayed on the screen and need selecting, use this key to change the selection (focus) among the objects to be manipulated. When a softkey menu is selected, the menu name area at the top of the menu is displayed in blue. When a data entry area is selected, the data entry bar is displayed in blue. When a table is selected, the frame of the table window is displayed in light gray. While a dialog box is displayed, the focus is fixed on the dialog box and cannot be changed.

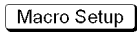
9. INSTR STATE Block

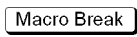
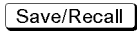
A group of keys related to the macro function, store and call function, control/management function, and the presetting of the E5070B/E5071B (returning it to the preset state).

 Key	Displays the “Macro Setup Menu” on page 693 on the right side of the screen. Manipulating the “Macro Setup Menu” enables you to start up the VBA editor or to create, call, or store a VBA project.
 Key	Executes a VBA procedure called “main” that has a VBA module named Module1.
 Key	Stops the VBA procedure being executed.
 Key	Displays the “Save/Recall Menu” on page 709 on the right side of the screen. Manipulating the “Save/Recall Menu” enables you to store to or read from the internal hard disk or floppy disk the setup conditions, calibration data, and trace data of the analyzer.
 Key	First, temporarily saves the data for the image displayed on the LCD screen the moment this key is pressed ^{*1} to the internal memory (clipboard). Immediately after that, displays the “System Menu” on page 718 on the right side of the screen. Manipulating the “System Menu” enables you to define the setup for the limit test and then execute it or to define the setup for the control and management of the analyzer. Using the Dump Screen Image key enables you to store the image data in the clipboard to a file on the internal hard disk or a floppy disk. Also, using the Print key in the System menu enables you to print the image data in the clipboard to a printer.
 Key	Displays the “Preset Menu” on page 708 on the right side of the screen. Pressing OK in the “Preset Menu” enables you to return the analyzer to the initial setup state, called the preset setup. For details on the initial setup for each of the functions, see Appendix C, “List of Default Values,” on page 629.

*1. Strictly speaking, the temporary save occurs the moment the “System Menu” is manipulated. Therefore, this also occurs when the menu bar is used to execute **5 Instr State - 5 System**.

10. MKR/ANALYSIS Block

A group of keys used for analyzing the measurement results by using the markers, fixture simulator, etc. For more on the functions of the keys in the MKR/ANALYSIS block, see Chapter 2 “Overview of Functions” in the *User’s Guide*.

Marker Key

Displays the “Marker Menu” on page 695 on the right side of the screen. Manipulating the “Marker Menu” enables you to turn the markers on/off and move them by entering stimulus values. You can place up to 10 markers on each trace.

Marker Search Key

Displays the “Marker Search Menu” on page 698 on the right side of the screen. Manipulating the “Marker Search Menu” enables you to move a marker to a specific point (maximum, minimum, peak, and a point with a target value) on a trace. You can also find the bandwidth parameters (up to six) and display them.

Marker Fctn Key

Displays the “Marker Function Menu” on page 697 on the right side of the screen. Manipulating the “Marker Function Menu” enables you to not only specify the marker sweep range and the coupling of markers on a channel but also to display statistics data on traces.

Analysis Key

Displays the “Analysis Menu” on page 647 on the right side of the screen. Manipulating the “Analysis Menu” enables you to use the analytical function called the fixture simulator.

11. Test Port

The port to which the DUT is connected. Options 213 and 214 each have two ports, Options 314 and 314 each have three ports, and Options 413 and 414 each have four ports. While signals are being output from a test port, the yellow LED above the test port is lit.

Connector type: 50 Ω, N-type, female

CAUTION



Do not apply DC voltage or current to the test port. Applying DC voltage or current may lead to device failure. In particular, the capacitor might remain charged. Connect the measurement sample (DUT) to the test port (or the test fixture, cables, etc. connected to the test port) after the analyzer has been completely discharged.

The test ports comply with Installation Category I of IEC 61010-1.

12. Front USB Port

A USB (Universal Serial Bus) port (number of parts: 1) specifically installed for an ECal (Electronic Calibration) module, a USB/GPIB interface, a multiport test set or a printer. Connecting a designated ECal module to this port enables ECal measurements to be taken. Connecting a compatible printer to this port enables screen information on the E5070B/E5071B to be printed. For more on executing ECal measurements, see Chapter 4, “Calibration,” on page 93, and for printing, see “Printing Displayed Screen” on page 369. The specifications of this port are identical to those of the “14. Rear USB port” on page 57.

NOTE

We do not support connections to the USB port of devices other than designated printers, ECal modules, the USB/GPIB interface, and multiport test sets.

13. Ground Terminal

Connected to the chassis of the E5070B/E5071B. You can connect a banana-type plug to this terminal for grounding.

Screen Area: Names and Functions of Parts

This section describes the names and functions of parts on the LCD screen of the E5070B/E5071B.

Figure 2-2

Screen display

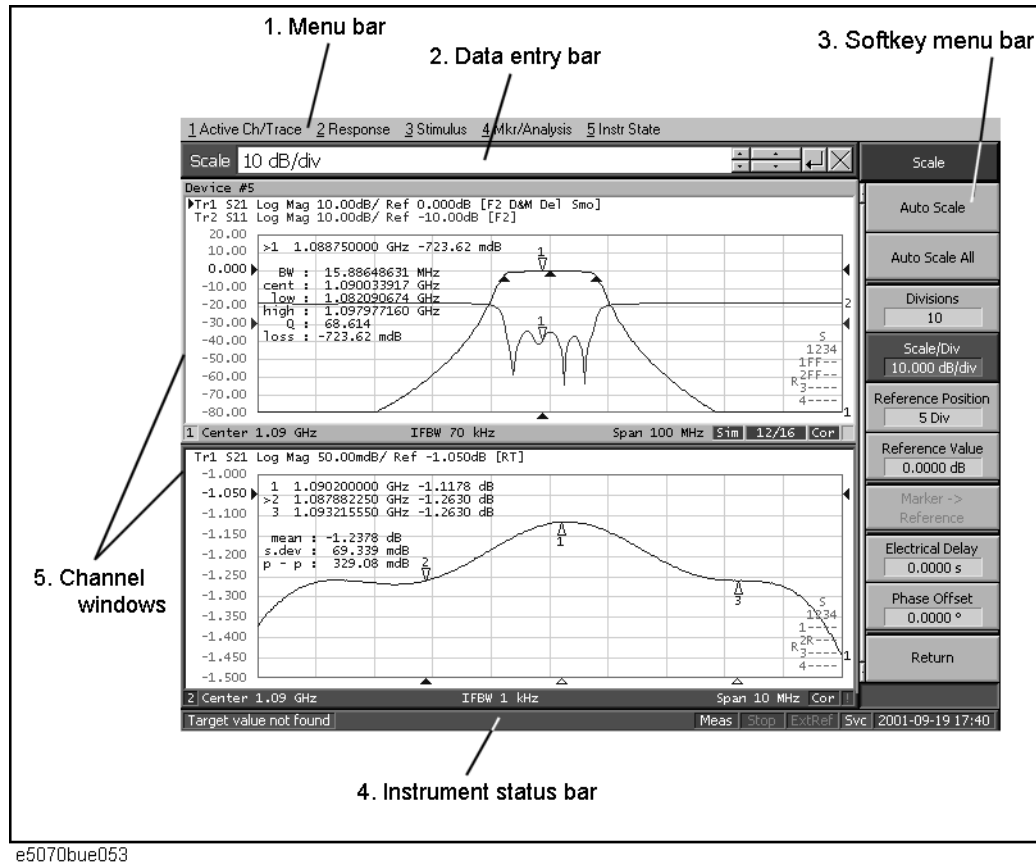

1. Menu Bar

By using the mouse and keyboard to manipulate the menu bar, you can perform interface operations that are equivalent to those of the keys in the ACTIVE CH/TRACE block, RESPONSE block, STIMULUS block, MKR/ANALYSIS block, and INSTR STATE block on the front panel of the E5070B/E5071B. The menus on the menu bar correspond to the key blocks, and their submenus to the hardkeys inside the key blocks.

2. Data Entry Bar

Used to enter numeric data into the E5070B/E5071B. Press a hardkey or softkey to enter data, and the data entry bar will appear at the top of the screen. To assign a title to a channel window, an entry bar that allows you to enter letters and symbols by using the front panel keys or mouse is displayed instead.

Figure 2-3

Data entry bar

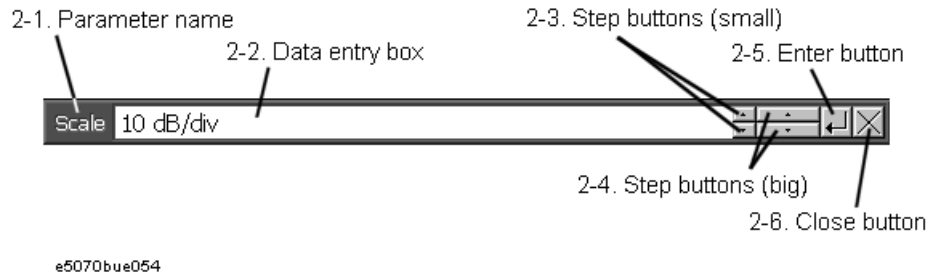

NOTE

To manipulate the data entry bar by using the front panel keys, the data entry bar must be selected as the object to manipulate (with the focus placed on it). When the focus is placed on the data entry bar, the entire bar is displayed in blue. Pressing or clicking **Focus** in the “8. ENTRY Block” on page 36 enables you to move the focus to the desired object.

2-1. Parameter Name

Displays the name of the parameter for which data will be entered.

2-2. Data Entry Area

When the data entry bar is displayed for the first time, the current settings are displayed on it. You can change numeric values by typing from the keyboard or in the ENTRY block on the front panel.

You can hide the frequency information in order to ensure its confidentiality or for other reasons. For detailed information, see “Hiding Softkey's Frequency Information” on page 89.

2-3. Step Button (Small)

Increases or decreases the numeric value in the data entry area in small steps. Use the mouse to manipulate this button.

2-4. Step Button (Large)

Increases or decreases the numeric value in the data entry area in large steps. Use the mouse to manipulate this button.

2-5. Enter Button

After typing numeric values in the data entry area by using the keyboard or the numeric keys in the ENTRY block on the front panel, press this button to finish the entry. Use the mouse to manipulate this button.

2-6. Close Button

Closes the data entry area (turns off the display). Use the mouse to manipulate this button.

3. Softkey Menu Bar

A group of keys on the screen called by the softkeys and menu bars. You can manipulate these keys by using the NAVIGATION block keys on the front panel, the mouse, or the keyboard. When a touch screen LCD (Option 016) is used, you can perform manipulations by directly touching the screen with your finger instead of using a mouse.

Figure 2-4

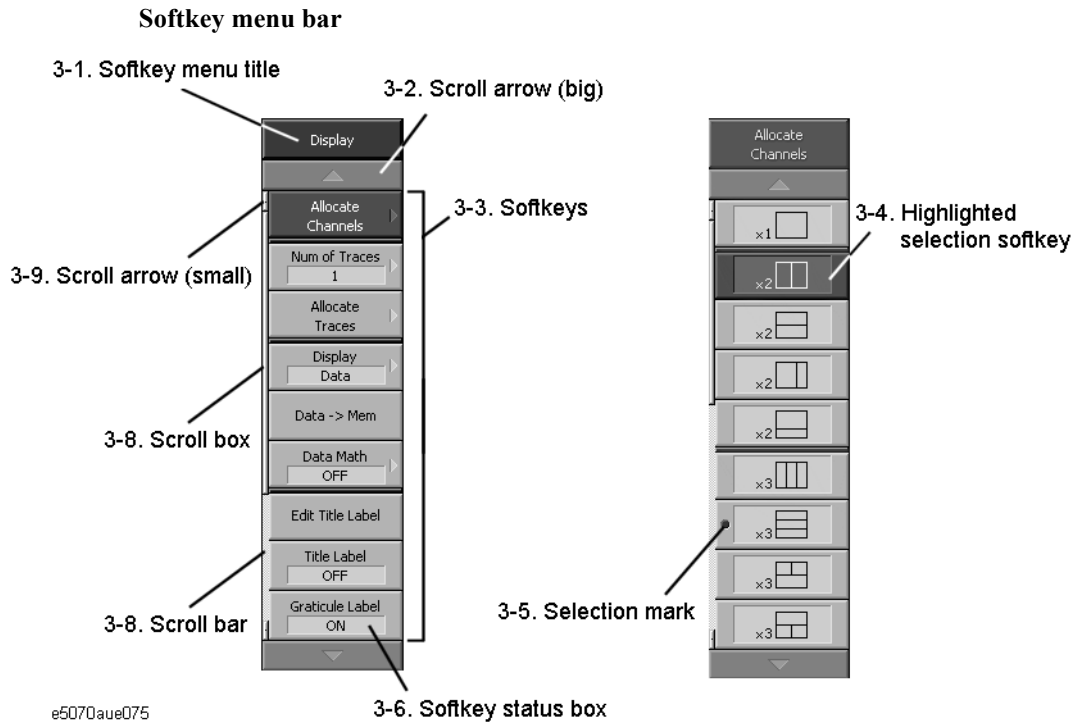

NOTE

To manipulate a menu bar, it has to be selected as the object to manipulate (with the focus placed on it). When the focus is placed on a menu bar, the menu title area at the top is displayed in blue. Pressing or clicking on **Focus** in the “8. ENTRY Block” on page 36 enables you to move the focus to the desired object.

3-1. Softkey Menu Title

The title of the softkey menu is displayed here. Double-clicking on this part of the menu bar displays the top layer of softkeys.













3-2. Scroll Arrow (Large)

When the softkeys in a menu overflow the screen, using this key enables you to scroll the menu page by page. Both upward and downward scroll arrows are available. Use the mouse to manipulate these buttons.

3-3. Softkeys

These are the actual keys you would use to perform setup. A ► displayed to the right of a softkey indicates that pressing that softkey will display the lower layer of softkeys.

3-4. Highlighted Softkey

Pressing  and  on the front panel or pressing  on the keyboard causes the highlighted (selected) softkey to be executed. You can change which softkey in the menu is highlighted by turning  or pressing   on the front panel or by pressing   on the keyboard. Pressing the  key on the front panel or the  key on the keyboard brings up the upper level softkey menu, and pressing the  key on the front panel or the  key on the keyboard brings up the lower level softkey menu.

3-5. Selection Mark

Shows which softkey function is currently selected.

3-6. Softkey Status Display

Displays a softkey's setup status.

You can hide the frequency information in order to ensure its confidentiality or for other reasons. For detailed information, see “Hiding Softkey's Frequency Information” on page 89.

3-7. Scroll Bar

When the softkeys in a menu overflow the screen, clicking on the blank part of the scroll bar enables you to scroll the softkey menu up or down.

3-8. Scroll Box

You can scroll the softkey menu up or down by using the mouse to select and drag the scroll box (pressing the button on the object to be moved and then releasing the button at the desired location). The length and position of the scroll box indicate the length and position of the currently displayed part of the softkey menu relative to the entire menu.

3-9. Scroll Arrow (Small)

Using this button, you can scroll the menu one softkey at a time. Both upward and downward scroll arrows are available. Use the mouse to manipulate these buttons.

4. Instrument Status Bar

The instrument status bar displays the status of the entire instrument.

Figure 2-5 Instrument status bar

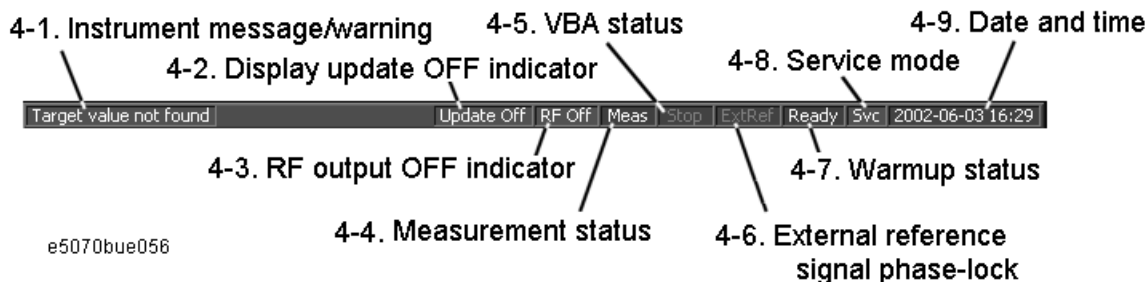

4-1. Instrument Message/Warning

Displays instrument messages and warnings. Instrument messages are displayed in gray and warnings in red. For the meanings of the instrument messages and warnings, see Appendix B, “Troubleshooting,” on page 607.

4-2. Display Update OFF Indicator

When updating of information displayed on the LCD screen is turned off, this indicator is displayed.

4-3. Rf Output OFF Indicator

When the stimulus signal output is turned off, this indicator is displayed.

4-4. Measurement Status

Displays the measurement status of the E5070B/E5071B.

Setup	Setup for measurement in progress
Hold	Measurement on hold (idling)
Init	Measurement being initialized
Man	The trigger source is set to “Manual” and waiting for trigger.
Ext	The trigger source is set to “External” and waiting for trigger.
Bus	The trigger source is set to “Bus” and waiting for trigger.
Meas	A measurement is in progress.

4-5. VBA Status

Displays the state of the execution of the VBA program in the E5070B/E5071B.

Run	A VBA program is currently running.
Stop	A VBA program has stopped.

4-6. External Reference Signal Phase Lock

When the frequency reference signal is input to the “10. External Reference Signal Input Connector (Ref In)” on page 56 on the rear panel and the measurement signal of the E5070B/E5071B is phase-locked to the reference signal, **ExtRef** is displayed in blue.

ExtRef (displayed in blue) Measurement signal is phase-locked to the external reference signal.

ExtRef (displayed in gray) Measurement signal is not phase-locked to the external reference signal.

NOTE

Even when the “9. High Stability Frequency Reference Output Connector (Ref Oven, Option 1E5 only)” on page 56 and “10. External Reference Signal Input Connector (Ref In)” on page 56 are connected, phase-locking may not occur immediately after power-on in a low-temperature environment. (The “ExtRef” display remains gray, not blue.) In such a case, wait a few minutes until the instrument has warmed up and the “ExtRef” display turns blue.

4-7. Warm-up Status

Ready (displayed in blue) Shows that warm-up of the instrument is completed.

Ready (displayed in gray) Shows that warm-up of the instrument is not completed.

4-8. Service Mode

Indicates the service mode status.

SVC (displayed in blue) The E5070B/E5071B is in service mode, which is used for self-diagnosis and repair of the E5070B/E5071B. Therefore, measurement performance will not be guaranteed according to the specifications. If, under normal use, the system remains in the service mode and does not return to normal operating mode, there is a possibility that the instrument is out of order.

SVC (displayed in red) An abnormal condition has been detected inside the E5070B/E5071B. The unit may be damaged. Notify the Customer Contact listed at the end of this manual or the distributor from whom the unit was purchased.

SVC (displayed in gray) The E5070B/E5071B is in normal mode.

4-9. Date and Time

Displays the date and time generated by the internal clock. The display format is as follows:

YYYY-MM-DD HH:MM **YYYY:** Year (AD)
 MM: Month
 DD: Day
 HH:MM: Time (0:00 to 23:59)

You can turn the date and time display on/off by manipulating the keys: **System** - **Clock Setup** - **Show Clock**.

5. Channel Window

Windows for displaying traces. Because a channel corresponds to a window, it is called a channel window. When the outer frame of a channel window is displayed in light gray, the channel is the active channel (the channel for which setup is being performed). In Figure 2-2 on page 40, channel 1 (the upper window) is the active channel. To make a channel active, use **Channel Next** or **Channel Prev**. Clicking inside a channel window will also make the channel active.

Figure 2-6

Channel Window

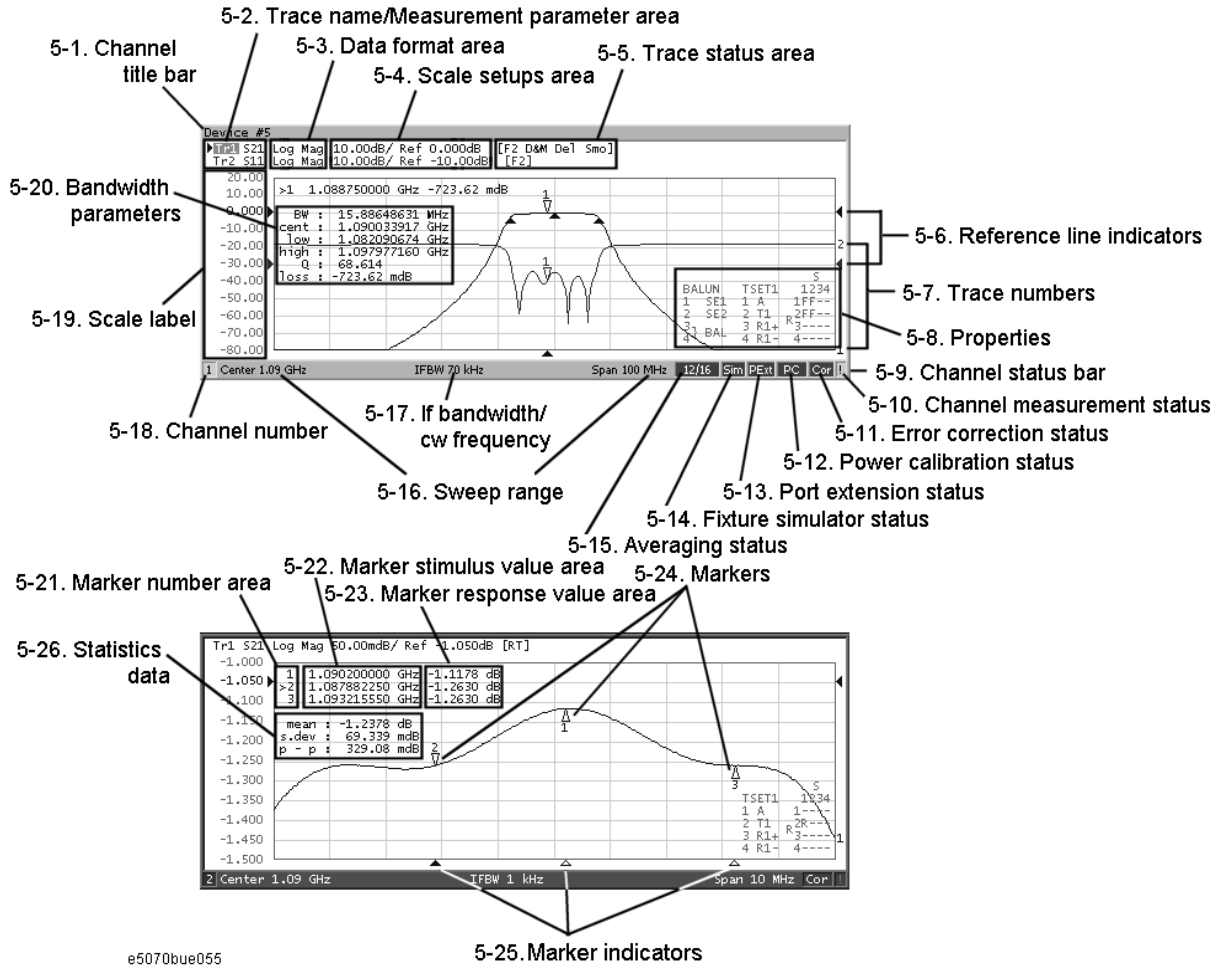



e5070bue055

5-1. Channel Title Bar

You can assign a title to each channel and have the title displayed on the bar. For more on setting up a channel title bar, see “Labeling a window” on page 89.

5-2. Trace Name/Measurement Parameter

The names of the traces (Tr1 through Tr9) on the channel and their measurement parameters are displayed here. ► to the right of the trace name indicates the active trace (the trace for which setup is being performed). To make a trace active, use **Trace Next** or **Trace Prev**. Clicking the line where the trace name is placed (the mouse pointer changes from  to ) also makes a trace active.

When an equation label is input using the equation editor, the measurement parameter changes to the equation label. For details, refer to “Entering the equation label” on page 279.

5-3. Data Format

The data format of each trace is displayed here. For more on setting up data formats, see “Selecting a Data Format” on page 81.

5-4. Scale Settings

The scale setting for each trace is displayed here. This example shows that “0.00dB/” corresponds to 10 dB per division. “Ref 0.000dB” shows that the value of the reference line is 0 dB. For more on setting scales, see “Setting the Scales” on page 85.

5-5. Trace Status Area

The setup for each trace is displayed here.



Table 2-1 Trace status display

Classification	Contents inside []	Meaning
Error correction	RO RS RT ER F1 F2 F3 F4	Error correction: ON (OPEN (n) response calibration) Error correction: ON (SHORT (n) response calibration) Error correction: ON (THRU (n) response calibration) Error correction: ON (Enhanced response calibration) Error correction: ON (1-port calibration) Error correction: ON (Full 2-port calibration / 2-port TRL calibration) Error correction: ON (Full 3-port calibration / 3-port TRL calibration) Error correction: ON (Full 4-port calibration / 4-port TRL calibration)
Turning on/off traces	Nothing M D&M off	Data trace: ON, Memory trace: OFF Data trace: OFF, Memory trace: ON Data trace: ON, Memory trace: ON Data trace: OFF, Memory trace: OFF
Performing data math	D+M (D+M&M) D-M (D-M&M) D*M (D*M&M) D/M (D/M&M)	Execution of Data+Mem math Execution of Data-Mem math Execution of Data*Mem math Execution of Data/Mem math
Electrical delay	Del	A numeric value other than 0 (zero) is specified as the electrical delay or phase offset.
Smoothing	Smo	Smoothing: ON
Gating	Gat	Gating: ON
Parameter conversion	Zr Zt Ztsh Yr Yt Ytsh 1/S Conj	Conversion: ON (Impedance: Reflection measurement) Conversion: ON (Impedance: Transmission measurement) Conversion: ON (Impedance: Transmission-Shunt measurement) Conversion: ON (Admittance: Reflection measurement) Conversion: ON (Admittance: Transmission measurement) Conversion: ON (Admittance: Transmission-Shunt measurement) Conversion: ON (Inverse S-parameter) Conversion: ON (Conjugation)
Power correction	PC	Error correction: ON (Power calibration)
Receiver correction	RC	Error correction: ON (Receiver calibration)
Scalar-mixer correction	Cor	Error correction: ON (Scalar-mixer calibration)

Table 2-1 Trace status display

Classification	Contents inside []	Meaning
Equation Editor	Equ	Equation editor: ON
	Equ!	Equation editor: ON (The equation refers to invalid data.)

5-6. Reference Line Indicators

The indicators that indicate the position of the reference line for the Y-axis scale in the rectangular display format. One indicator is to the right and the other is to the left of the scale (▶ and ◀). To enter a numeric value for the position of the reference line, open the data entry bar using the keys: **Scale** - **Reference Position**. You can also move the position of the reference line by placing the mouse pointer on either of the two reference line indicators (the pointer changes from  to ), moving the indicator vertically with the left mouse button kept pressed, and then releasing the button at the desired location (i.e., a drag-and-drop operation).

5-7. Trace Number

In the rectangular display format, the trace number is displayed in the same color as the trace at the right end of each trace.

5-8. Properties

Displays the following properties.

Figure 2-7

Properties

Balanced Measurement Topology Property	E5091A Property	Calibration Property
BALUN	TSET1	S
1 SE1	1 A	1234
2 SE2	2 T1	1FF --
3 } BAL	3 R1+	2FF --
4 }	4 R1 -	R 3 ----
		4 ----

e5070bue057

- Calibration Property Displays the status of the obtained calibration coefficients on the channel. For details, see “Acquisition status of calibration coefficient for each channel” on page 103.
- E5091A Property Displays the assignment information of the test ports on the channel. For details, see “Displaying the E5091A properties” on page 479.
- Balanced Measurement
Topology Property Displays the topology for balanced measurement on the channel. For details, see “Checking device type and port assignment” on page 299.

5-9. Channel Status Bar

The status of each channel is displayed here (see parts 5-10 through 5-16).

5-10. Channel Measurement Status

Displays the update status of traces on the channel.

!	Measurement in progress. When the sweep time exceeds 1.5 seconds, ↑ is displayed at the point on the trace.
#	Invalid traces. The measurement conditions have changed, but the traces on the channel currently displayed have not been updated to match the new conditions.
(No display)	The measurement has not been executed.

5-11. Error Correction Status

Displays the execution status of error correction on the channel. For details, see “Execution status of error correction for each channel” on page 102.

5-12. Power Calibration Status

Displays the execution status of power level error correction on the channel. For details, see “Turning ON or OFF power level error correction” on page 208.

5-13. Port Extension Status

Shows whether the port extension is turned ON or OFF.

PExt (displayed in blue)	Port extension: ON
(not displayed)	Port extension: OFF

5-14. Fixture Simulator Status

Shows whether the fixture simulator is turned ON or OFF.

Sim (displayed in blue)	Fixture simulator: ON
(not displayed)	Fixture simulator: OFF

5-15. Averaging Status

Displays the averaging factor and averaging count when averaging is turned on.

n/m (displayed in blue)	Averaging: ON (m: averaging factor; n: averaging count)
(not displayed)	Averaging: OFF

5-16. Sweep Range

Indicates the sweep range by using the start/stop or center/span.



5-17. IF Bandwidth/CW Frequency

Indicates the IF bandwidth when the sweep type is linear/log frequency or the CW frequency when the sweep type is power.

5-18. Channel Number

Indicates the channel number.

5-19. Graticule Labels

Y-axis divisions in the rectangular display format. When traces in the rectangular display format are overlaid, the Y-axis divisions for the active trace are displayed. The value of the reference line (the division line between ► and ◀) is entered numerically by opening the data entry bar using the keys: **Scale** + **Reference Value**. You can change values of the reference line at one-division intervals by placing the mouse pointer in the area of the graticule label (the pointer changes from  to ) , moving the pointer vertically with the left mouse button pressed, and then releasing the button at the desired location.

5-20. Bandwidth Parameters

Turning on the bandwidth search function displays the bandwidth parameters here. For more on the bandwidth search function, see “Determining the Bandwidth of the Trace (Bandwidth Search)” on page 270.

5-21. Marker Numbers

The marker values are displayed in a list at positions 5-21, 5-22, and 5-23. Position 5-21 displays the marker numbers. For the active marker (the one for which setup and analysis are being performed), > is displayed to the left of the marker number. For the reference marker, △ is displayed instead of the marker number.

5-22. Marker Stimulus Values

The marker stimulus value for each marker (the frequency/power level at the marker point) is displayed here.

5-23. Marker Response Values

The marker response value for each marker (the measurement value at the marker point) is displayed here. Two (or three) response values are displayed for data in Smith chart or polar display format.

5-24. Markers

The markers used for reading values on a trace. Up to 10 markers can be displayed for each trace.



Active marker (the one for which setup and analysis are being performed)





Non-active marker

Here, “n” denotes a marker number. For the reference marker, however, nothing is displayed at the location of n. Clicking the marker or one of the “5-25. Marker Indicators” makes the marker active.

5-25. Marker Indicators

Indicates the positions of markers on the stimulus axis.

- ▲ Active marker indicator
- △ Non-active marker indicator

You can also move a marker to the desired position by placing the mouse pointer on the marker indicator or position of the marker itself (the pointer changes from  to ) , moving the indicator vertically with the left mouse button pressed, and then releasing the button at the desired location.

5-26. Statistics Data

Turning on the statistics data function displays statistics data here. For more on the statistics data function, see “Determining the Mean, Standard Deviation, and p-p of the Trace” on page 272.

Rear Panel: Names and Functions of Parts

This section describes the names and functions of the parts on the rear panel of the E5070B/E5071B.

Figure 2-8 Rear panel

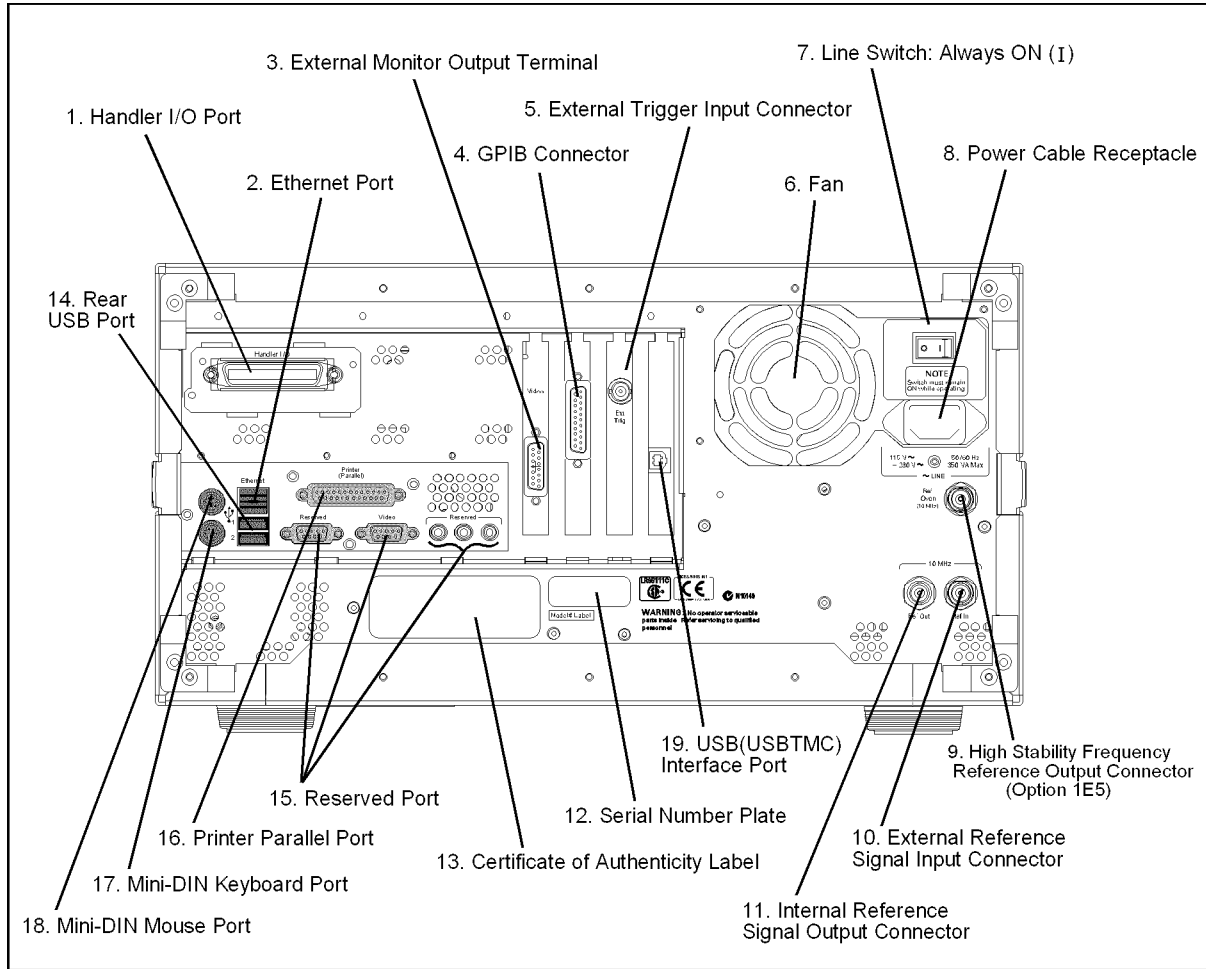

e5070bue7010

1. Handler I/O Port

The terminal to which an automatic machine (handler) used on a production line is connected. For more on using the handler I/O port, see the Programmer's Guide.

Connector type: 36-pin Ribbon (Centronics) connector

2. Ethernet Port

A terminal for connecting the E5070B/E5071B to a LAN (Local Area Network). Connecting this instrument to a LAN enables you to access the hard disk drive of this instrument from an external PC or to control this instrument by using SICL-LAN or telnet.

Connector type: 8-pin RJ-45 connector

Base standard: 10Base-T/100Base-TX Ethernet (automatic data rate selection)

3. External Monitor Output Terminal (Video)

A terminal to which an external color monitor (display device) can be connected. By connecting a color monitor to this terminal, the same information shown on the LCD screen of the main body can be displayed on an external color monitor.

Connector type: 15-pin VGA connector, female

4. GPIB Connector

General Purpose Interface Bus (GPIB). The connection of an external controller and other devices through this connector allows you to configure an automatic measurement system. For more on the automatic measurement system using GPIB, see the *Programmer's Guide*.

5. External Trigger Input Connector (Ext Trig)

A connector to which external trigger signals are input. This connector detects the downward transition from the HIGH state in TTL signals as the trigger signal. To use this connector to generate a trigger, you must set the trigger source to the "external" side (key operation: Trigger - **Trigger Source - External**).

Connector type: BNC connector, female

6. Fan

The cooling fan for controlling the temperature inside the E5070B/E5071B. This fan exhausts heated air from inside the analyzer to the outside.

7. Line Switch (Always ON)

Always keep this switch on (I).

CAUTION

Do not use this switch to turn off (O) the mains. Doing so may cause the analyzer to fail. For more information, see the description of the "1. Standby Switch" on page 31.

8. Power Cable Receptacle (to LINE)

The receptacle (outlet) to which the power cable is connected.

NOTE

To connect the device to a power source (outlet), use the supplied three-prong power cable with a ground conductor.

The plug attached to the power cable (on the power outlet side or device side of the cable) serves as the disconnecting device (device that cuts off power supply) of the E5070B/E5071B. When the power supply must be cut off to avoid such danger as electric shock, pull out the power cable plug (on the power outlet side or device side of the cable). For the procedure for turning off the mains in normal use, see the description in “1. Standby Switch” on page 31.

For more on the power supply, see Chapter 2 “Installation” in the Installation and Quick Start Guide.

9. High Stability Frequency Reference Output Connector (Ref Oven, Option 1E5 only)

When Option 1E5 (high stability frequency reference) is installed, the reference signal is output from this connector.

Connector type: BNC connector, female

Output signal (Nominal): 10 MHz, +0 dBm \pm 3 dB

NOTE

When Option 1E5 (high stability frequency reference) is installed, connect this connector to the “10. External Reference Signal Input Connector (Ref In)” on page 56 by using the BNC(m)-BNC(m) cable included with the option.

10. External Reference Signal Input Connector (Ref In)

The reference signal input connector for phase-locking the measurement signal from the E5070B/E5071B to the external frequency reference signal. Inputting the reference signal to this connector improves the accuracy and frequency stability of the measurement signal from the E5070B/E5071B.

Connector type: BNC connector, female

Input signal (Nominal): 10 MHz \pm 10 ppm, +0 dBm \pm 3 dB

NOTE

When the frequency reference signal is input to this connector, the measurement signal from the E5070B/E5071B is automatically phase-locked to the reference signal. When an input signal is not present, the frequency reference signal inside the E5070B/E5071B is automatically used. The **ExtRef** on the instrument status bar is displayed in blue when the system is phase-locked to the external reference signal and in gray when not phase-locked.

When using Option 1E5 (high stability frequency reference), connect this connector to the “9. High Stability Frequency Reference Output Connector (Ref Oven, Option 1E5 only)” on page 56 by using the BNC(m)-BNC(m) cable included with the option.

11. Internal Reference Signal Output Connector (Ref Out)

A connector for outputting the internal frequency reference signal from the E5070B/E5071B. By connecting this output connector to the external reference signal input connector of another device, the device can be phase-locked to the internal reference signal of the E5070B/E5071B and used under this condition.

Connector type: BNC connector, female
Output signal (Nominal): 10 MHz, +0 dBm \pm 3 dB
Output impedance (Nominal): 50 Ω

12. Serial Number Plate

The seal showing the serial number of the product.

13. Certificate of Authenticity Label

The label showing the information of the “Certificate of Authenticity.”

14. Rear USB port

A USB (Universal Serial Bus) port (number of ports: 2) specifically installed for an ECal (Electronic Calibration), a USB/GPIB interface, a multiport test set or a printer. The specifications of this port are identical to the “12. Front USB Port” on page 39.

15. Reserved Port (Reserved)

These two ports are not available for connections.

16. Printer Parallel Port

A 25-pin parallel port for printer connection. Connecting a designated printer to this port allows screen information on the E5070B/E5071B to be printed. For more on printing, see “Printing Displayed Screen” on page 369.

17. Mini-DIN Keyboard Port

A port to which a mini-DIN type keyboard is connected. The keyboard can be used to edit VBA programs inside the E5070B/E5071B or to enter file names. Since the arrow keys and numeric keys on the keyboard work in the same way as the arrow keys and numeric keys on the front panel of the E5070B/E5071B, you can use it instead of front panel operation.

NOTE

Be sure to only use a keyboard designated for use with this instrument. Using a keyboard other than those designated may cause erroneous input.

18. Mini-DIN Mouse Port

The port to which a mini-DIN type mouse is connected. Using a mouse enables you to more efficiently perform the operations of menu bars, softkeys, and dialog boxes as well as selecting an active channel or an active trace. The mouse also enables you to move a marker or the scale reference line by using drag-and-drop operations.

NOTE

Be sure to only use a mouse designated for use with this instrument. Using a mouse other than those designated may cause erroneous input.

19. USB (USBTMC) Interface Port

Through this port, you can control the E5070B/E5071B from external controllers. For more information on the measurement system using the USB port, see the Programmer's Guide.

Connector Types: Universal serial bus (USB) jack, type B (4 contact positions), Female

Compliance Standards: USBTMC-USB488 and USB2.0

3 Setting Measurement Conditions

This chapter describes how to set up the measurement conditions for the Agilent E5070B/E5071B Network Analyzer.

Initializing Parameters

The E5070B/E5071B has three different initial settings as shown in Table 3-1 below.

Table 3-1 E5070B/E5071B Initial settings and methods for restoring them

Initial setting	Restore method
Preset state	<ul style="list-style-type: none">• Press Preset - OK on the front panel*¹or• Execute the :SYST:PRES command
*RST state	Execute the *RST command
Factory default setting	(how the E5070B/E5071B is set up prior to shipment from the factory)

*1. Initialization may be executed without displaying the **OK** or **Cancel** button, depending on the instrument setting state. For more information, see “Showing/hiding the confirmation buttons when presetting” on page 449.

The user can set items to be preset freely. For more information, see “Setting the user preset function” on page 449.

For further details of each setting, refer to Appendix C, “List of Default Values,” on page 629. To restore initial settings using commands, refer to the *Programmer’s Guide* and *VBA Programmer’s Guide*.

Setting Channels and Traces

The E5070B/E5071B allows you to use up to 16 channels (when the number of traces is up to 4) to perform measurement under 16 different stimulus conditions.

For each channel, up to 16 traces (measurement parameters) can be displayed (when the number of channels is up to 4). Because multiple traces can be displayed for each channel, no feature is provided to link the stimulus conditions between channels, and each channel is always independent of the others. In other words, for the E5070B/E5071B, you need to set the measurement conditions and execute calibration for each channel you use for measurement.

With the E5070B/E5071B, you can change the number of available channels and the upper limit of the number of traces. If you change the upper limit setting, you need to restart the firmware of the E5070B/E5071B. Therefore, first, set the upper limit appropriately depending on the numbers of channels and traces necessary for your measurement.

When you set items whose setting target is channels/traces (refer to “Parameter setting for each setup item (analyzer, channel, trace)” on page 67), the target is the selected (active) channel/trace. You can specify only the displayed channels/traces as active channels/traces. Therefore, set the display of channels/traces before setting the measurement conditions.

Setting upper limits of number of channels/traces

You can select the upper limits of the number of channels and the number of traces from the following combinations.

- 1 channels and 4 traces
- 2 channels and 4 traces
- 4 channels and 16 traces
- 9 channels and 9 traces
- 12 channels and 6 traces
- 16 channels and 4 traces

You may want to select the "1-channel, 4-trace" or "2-channel, 4-trace" configuration to save the time required to save/call the instrument state file, since this takes longer with other configurations.

NOTE

It's important to realize that the combination used to save a state file must be the same used to recall it; that is, you cannot save a state file with one combination of channels/traces and recall it with another combination. For more details, see “Saving and Recalling Instrument State” on page 352.

NOTE

When more than 1601 measurement points is set for 1 channel and 4 traces, the E5070B/E5071B VBA macro function may not operate.

The selection procedure is as follows:

- Step 1.** Press **System**.
- Step 2.** Press **Misc Setup**.
- Step 3.** Press **Channel/Trace Setup**.
- Step 4.** Press the desired softkey to select the upper limits of the number of channels and the number of traces.

Setting Measurement Conditions

Setting Channels and Traces

Step 5. Press **Return**. The dialog box that prompts you to restart the firmware appears. Click the **Yes** button to restart the firmware.

Setting channel display (layout of channel windows)

The measurement result for each channel is displayed in its dedicated window (channel window). You cannot have a single window display the measurement results from more than one channel. This means that the setting of the window layout determines the number of channels displayed on screen.

NOTE

The execution of measurement for each channel does not depend on how the channel is displayed (channels that are not displayed can be measured). For information on executing measurement for each channel (trigger mode and trigger source), refer to Chapter 5, “Making Measurements,” on page 241.

The procedure for setting the window layout is as follows:

Step 1. Press **Display**.

Step 2. Press **Allocate Channels**.

Step 3. Press the desired softkey to select the window layout (refer to Figure 3-1).

Figure 3-1

Layout of channel windows

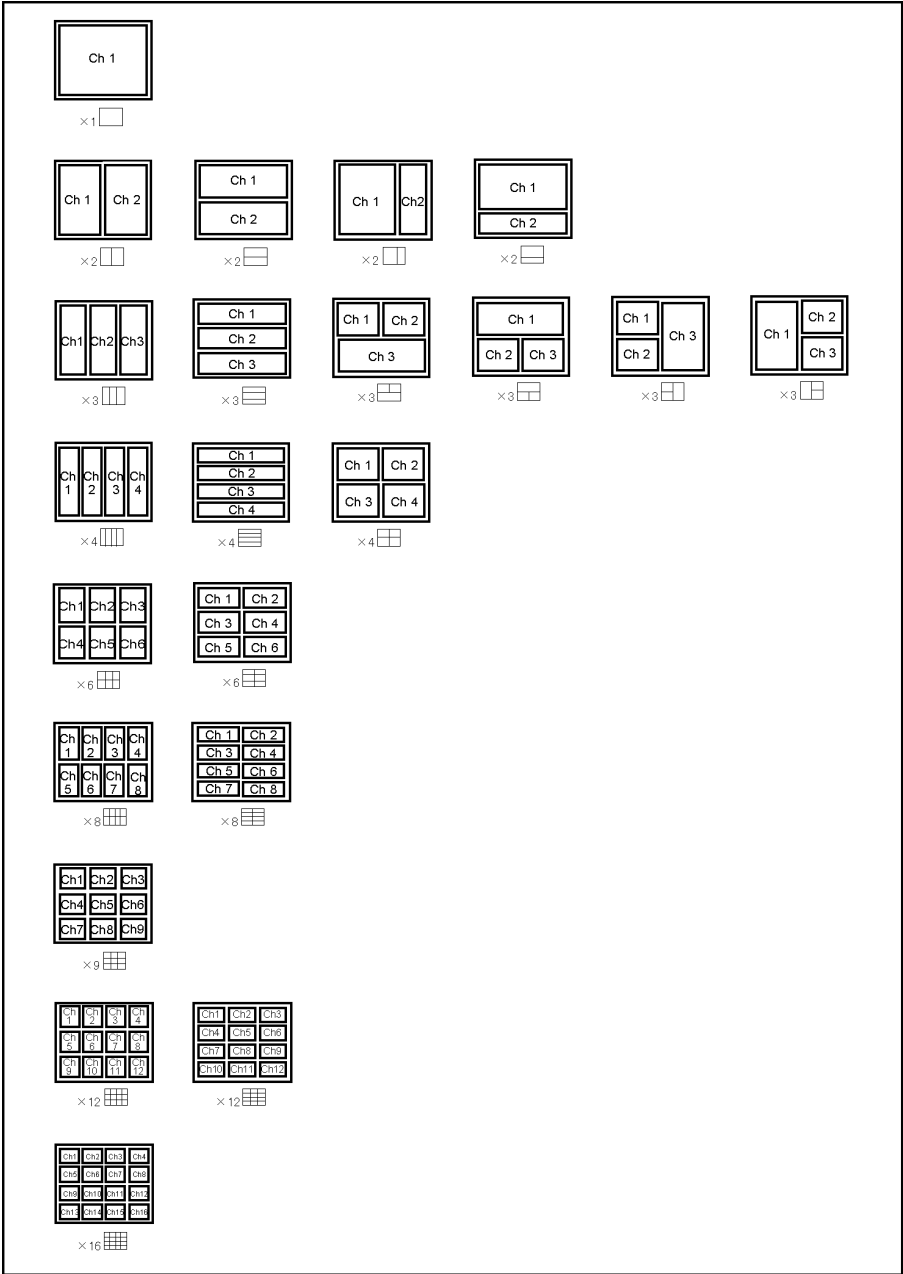

e5070buy002

Setting trace display

Setting the number of traces

Depending on the measurement parameters of the traces displayed for each channel, the sweep necessary for each channel is executed. For more information, refer to “Sweep Order in Each Channel” on page 242.

You specify the trace display by setting the number of traces (upper limit of displayed trace numbers). For example, if you set the number of traces to 3, traces 1 through 3 are displayed.

The procedure for setting the number of traces is as follows:

- Step 1.** Press **Channel Next** or **Channel Prev** to select the channel for which you want to set the number of traces.
- Step 2.** Press **Display**.
- Step 3.** Press **Number of Traces**.
- Step 4.** Press the desired softkey to set the number of traces.

Setting trace layout (graph layout)

Traces are laid out and displayed in the order of the trace number from graph 1 according to the graph layout in the channel window.

You can select the graph layout from Figure 3-2.

If the number of traces is less than the number of graphs, nothing is displayed in the remaining area. If the number of traces you set exceeds the number of graphs, excess traces are superimposed from the first graph. For example, if you select **x3** as the graph layout and set the number of traces to 5, graph 1 (Gr1 in Figure 3-2) and graph 2 (Gr2 in Figure 3-2) display traces 1 and 4 and traces 2 and 5, respectively, by superimposing, and graph 3 (Gr3 in Figure 3-2) displays only trace 3 as shown in the figure below.

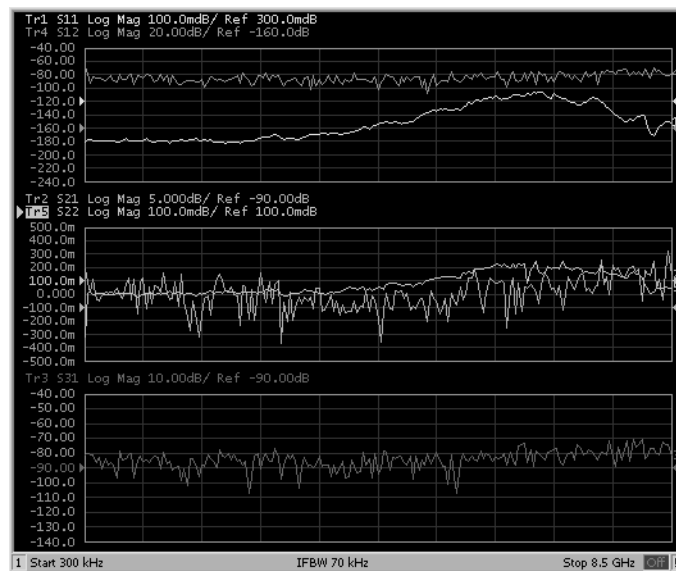

The procedure for setting the graph layout is as follows:

- Step 1.** Press **Channel Next** or **Channel Prev** to select the channel for which you want to set the graph layout.
- Step 2.** Press **Display**.
- Step 3.** Press **Allocate Traces**.
- Step 4.** Press the desired softkey to select the graph layout (refer to Figure 3-2).

Figure 3-2

Graph layout

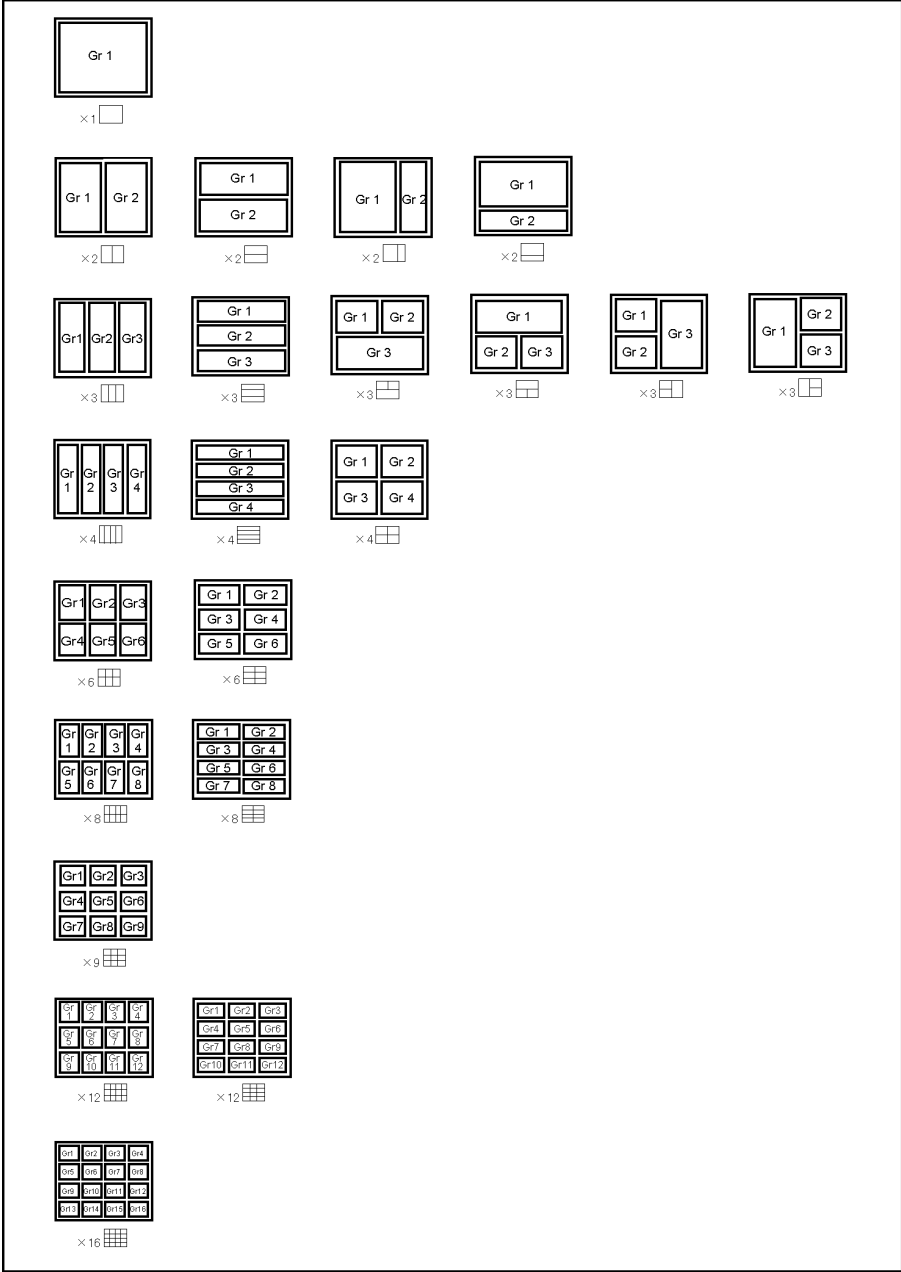

e5070bu003

Active channel

The active channel is the one whose settings can currently be changed. The window frame of the active channel is displayed brighter than the window frames of the other channels. To change the settings specific to a certain channel, you must first activate the channel.

To change the active channel, use the following hardkeys:

Hardkey	Function
Channel Next	Change the active channel to the next channel with the larger channel number.
Channel Prev	Change the active channel to the previous channel with the smaller channel number.

Active trace

The active trace is the one whose settings can currently be changed. The trace name on the screen (for example, Tr3) of the current active trace is highlighted and indicated with ► to the left. To change the settings specific to a certain trace, you must first activate the trace.

To select the active trace, use the following hardkeys:

Hardkey	Function
Trace Next	Change the active trace to the next trace with the larger trace number.
Trace Prev	Change the active trace to the previous trace with the smaller trace number.

Parameter setting for each setup item (analyzer, channel, trace)

Table 3-2 lists the setting parameters and indicates the setup item (analyzer, channel, or trace) that each parameter controls along with the applicable setup key(s).

Table 3-2 Parameters and setup items they control

Parameter	Controlled Setup Items			Setup Key(s)
	Analyzer	Channel	Trace	
Stimulus Settings				
Sweep range		✓		<input type="button" value="Start"/> <input type="button" value="Stop"/> <input type="button" value="Center"/> <input type="button" value="Span"/>
Power, CW frequency		✓		<input type="button" value="Sweep Setup"/> - Power
Sweep time/Sweep delay time		✓		<input type="button" value="Sweep Setup"/> - Sweep Time/Sweep Delay
Number of points		✓		<input type="button" value="Sweep Setup"/> - Points
Segment sweep		✓		<input type="button" value="Sweep Setup"/> - Sweep Type /Edit Segment Table/Segment Display
Sweep mode		✓		<input type="button" value="Sweep Setup"/> - Sweep Mode
Trigger Settings				
Trigger source	✓			<input type="button" value="Trigger"/> - Trigger Source/Restart/Trigger
Trigger mode		✓(*1)		<input type="button" value="Trigger"/> - Hold/Hold All Channels /Single /Continuous/Continuous Disp Channels
Response Settings				
Measurement parameter			✓	<input type="button" value="Meas"/>
Data format			✓	<input type="button" value="Format"/>
Scale, Electrical delay, Phase offset			✓(*2)	<input type="button" value="Scale"/>
Memory trace and data math			✓	<input type="button" value="Display"/> - Display /Data → Mem /Data Math
Window title		✓		<input type="button" value="Display"/> - Edit Title Label /Title Label (ON/OFF)
Graticule label in rectangular form		✓		<input type="button" value="Display"/> - Graticule Label (ON/OFF)
Color inversion	✓			<input type="button" value="Display"/> - Invert Color
Frequency display ON/OFF	✓			<input type="button" value="Display"/> - Frequency (ON/OFF)
Display update ON/OFF	✓			<input type="button" value="Display"/> - Update (ON/OFF)
Averaging		✓		<input type="button" value="Avg"/> - Averaging Restart /Avg Factor/Averaging (ON/OFF)
Smoothing			✓	<input type="button" value="Avg"/> - Smo Aperture /Smoothing (ON/OFF)

Setting Measurement Conditions
Setting Channels and Traces

Table 3-2 Parameters and setup items they control

Parameter	Controlled Setup Items			Setup Key(s)
	Analyzer	Channel	Trace	
IF bandwidth		✓		<input type="button" value="Avg"/> - IF Bandwidth
Calibration		✓		<input type="button" value="Cal"/>
Marker			✓(*3)	<input type="button" value="Marker"/> <input type="button" value="Marker Search"/> <input type="button" value="Marker Fctn"/>
Analysis				
Fixture simulator		✓(*4)		<input type="button" value="Analysis"/> - Fixture Simulator
Time domain			✓	<input type="button" value="Analysis"/> - Gating <input type="button" value="Analysis"/> - Transform
Parameter conversion			✓	<input type="button" value="Analysis"/> - Conversion
Limit test			✓	<input type="button" value="Analysis"/> - Limit Test
Saving and recalling data	✓			<input type="button" value="Save/Recall"/>
Macro	✓			<input type="button" value="Macro Setup"/> <input type="button" value="Macro Run"/> <input type="button" value="Macro Break"/>
System				
Printing/Saving display Screen/Beeper/GRIB settings/Network Settings/Date & Time/Key Lock/Backlight/Firmware Revision/Service menu	✓			<input type="button" value="System"/>
Preset	✓			<input type="button" value="Preset"/>

*1. **Hold All Channels** for the analyzer.

*2. **Auto Scale All** and scale **Divisions** must be set up in rectangular form for each channel.

*3. Turning the marker table display on or off applies to the entire analyzer. On the other hand, the sweep range setting of the marker must be performed for each channel. In the preset condition, marker coupling is enabled and marker settings and movements are effective for all traces on a channel.

*4. The balanced-unbalanced conversion function (**BalUn ON/OFF**) must be turned on or off for each trace.

Setting the System Z0

NOTE

This function is available with the firmware version 3.01 or greater.

The procedure for setting the system characteristic impedance (Z0) is as follows:

- Step 1.** Press .
- Step 2.** Press **Set Z0**.
- Step 3.** Enter the system Z0 using the ENTRY block keys on the front panel.

Setting Stimulus Conditions

You can set the stimulus condition for each channel independently.

Setting sweep type

You can select the sweep type from the following four types.

Sweep type	Description
Linear	Sweeps frequencies in linear scale.
Log	Sweeps frequencies in logarithmic scale.
Segment	Performs a sweep with linear sweep conditions (segments) combined. For more information, refer to “Performing a Segment-by-Segment Sweep (segment sweep)” on page 415.
Power	Sweeps power levels in linear scale.

The procedure for selecting the sweep type is as follows:

- Step 1.** Press **Channel Next** or **Channel Prev** to select the channel for which you want to set the sweep type.
- Step 2.** Press **Sweep Setup**.
- Step 3.** Press **Sweep Type**.
- Step 4.** Press the desired softkey to select the sweep type.

Setting the Sweep Range

There are two ways to set the sweep range: by specifying the lowest and the highest values and by specifying the center value and a span. Once the sweep range is set, it is possible to change the range by substituting the lowest value, the highest value, or the center value with a value (stimulus value) represented by a marker on the trace.

Figure 3-3

Setting the sweep range

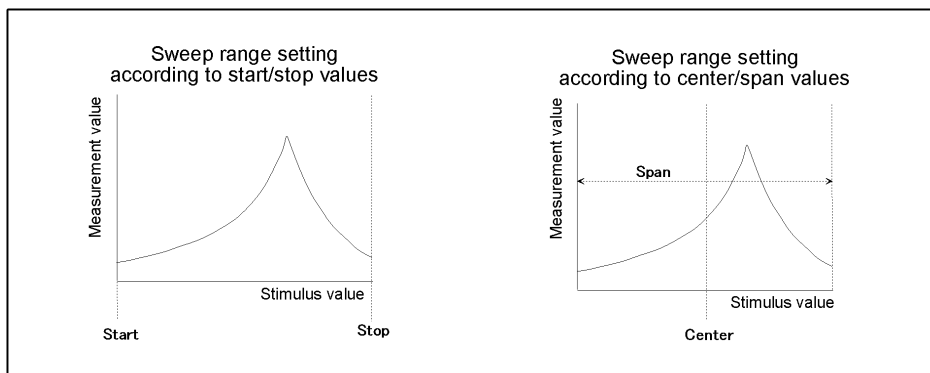

e5070bue001

Setting the Sweep Range with the Lowest and Highest Values

- Step 1.** Press **Channel Next** or **Channel Prev** to select the channel whose sweep range will be set.
- Step 2.** Press **Start**.
- Step 3.** Using the ENTRY block keys on the front panel, input the lowest value.
- Step 4.** Press **Stop**.
- Step 5.** Using the ENTRY block keys on the front panel, input the highest value.

Setting the Sweep Range with the Center Value and a Span

- Step 1.** Press **Channel Next** or **Channel Prev** to select the channel whose sweep range will be set.
- Step 2.** Press **Center**.
- Step 3.** Using the ENTRY block keys on the front panel, input the center value.
- Step 4.** Press **Span**.
- Step 5.** Using the ENTRY block keys on the front panel, input a span value.

Setting the Sweep Range Using the Marker

- Step 1.** In the channel window whose range must be set, place the active marker on the active trace to a position that corresponds to the new range (to the lowest, highest, or center value).
- Step 2.** Press **Marker Fctn**.
- Step 3.** Press the softkey that corresponds to each value.

Softkey	Function
Marker → Start	Sets the lowest value to the stimulus value of the active marker on the currently active trace.
Marker → Stop	Sets the highest value to the stimulus value of the active marker on the currently active trace.
Marker → Center	Sets the center value to the stimulus value of the active marker on the currently active trace.

NOTE

If the reference marker is on and the stimulus value of the active marker is expressed by a value relative to the reference marker, the absolute stimulus value will be used to set the new sweep range.

Setting Measurement Conditions
Setting Stimulus Conditions

Figure 3-4 Setting the sweep range using the marker

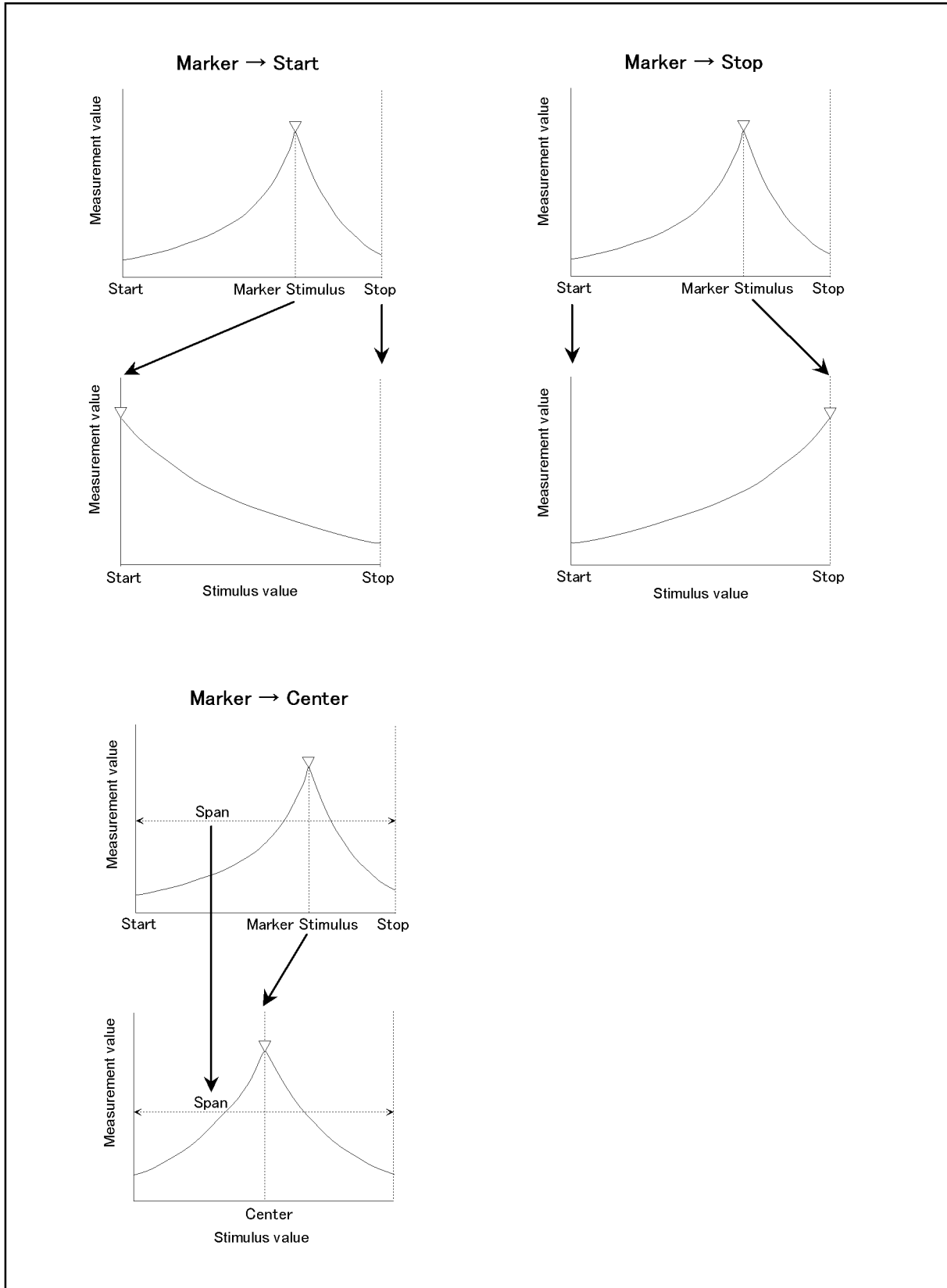

e5070aue118

Turning stimulus signal output on/off

You can turn on/off the stimulus signal output, but this will prevent you from performing measurement. Therefore, you will not normally use this feature. This is mainly used to turn the output back to on after it has been turned off by the power trip feature.

Follow these steps to turn the stimulus signal output on/off:

- Step 1.** Press **Sweep Setup**.
- Step 2.** Press **Power**.
- Step 3.** Press **RF Out**. Each press toggles between on/off.

When set to off, “RF OFF” is displayed in “4. Instrument Status Bar” on page 44.

Power trip

The power trip is a feature that the instrument uses to automatically turn off the output of the stimulus signal to protect the instrument when a signal whose level exceeds the upper limit is inputted to the test port.

If the power output is automatically turned off by the power trip feature, remove the cause of the over-input and turn on the power output according to the above steps to restart the measurement.

Setting fixed frequency at power sweep

The procedure for setting the fixed frequency (CW frequency) at the power sweep is as follows:

- Step 1.** Press **Channel Next** or **Channel Prev** to select the channel for which you want to set the fixed frequency.
- Step 2.** Press **Sweep Setup**.
- Step 3.** Press **Power**.
- Step 4.** Press **CW Freq**.
- Step 5.** Enter the fixed frequency using the ENTRY block keys on the front panel.

Setting power level with Auto Power Range set function

When the Auto Power Range set function is effective, the proper source attenuator and power range are selected automatically, as shown by the figures below, according to the maximum frequency and maximum output power of each channel (except for instruments with option 213, 313, or 413).

NOTE

Under the following conditions, turn OFF the Auto Power Range set function and set the power range and power level manually, according to **Setting power range manually** on page 77.

- When different power ranges are selected in multiple channel measurement settings. In this case, an error message is displayed to avoid source attenuator damage. (For example: When Channel 1's stop frequency is 8 GHz and Channel 2's stop frequency is 2 GHz with a 0 dBm setting, the error message "Continuous switching may damage source attenuator" is displayed because each selected power range is different.
- When you cannot obtain the desirable power sweep range. (For example, if you want to set start power to -25 dBm and stop power to 7 dBm at 2 GHz CW, you cannot set the start power level below -20 dBm when Auto Power Range set function is ON.)

Figure 3-5 Available power level and selected power range with Auto Power Range set function ON (when maximum frequency is 3 GHz or below)

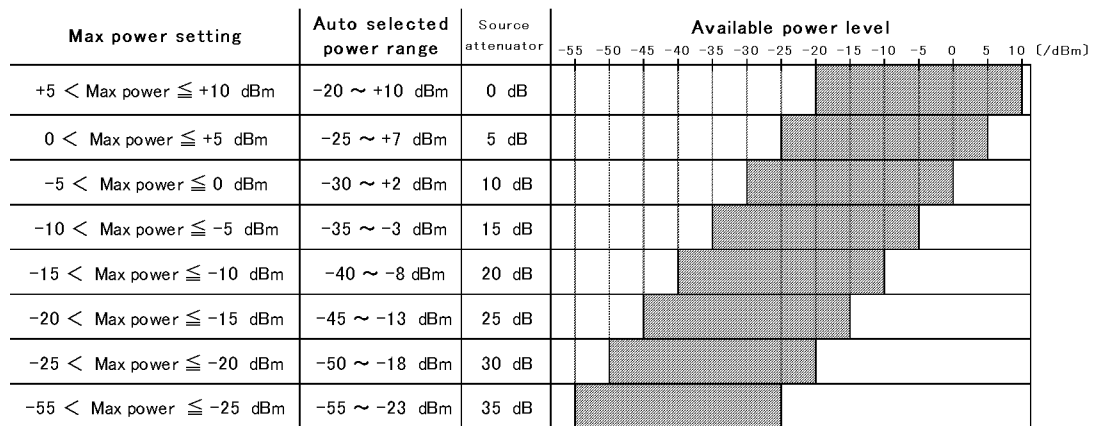

e5070bue0101

Figure 3-6

Available power level and selected power range with Auto Power Range set function ON (when maximum frequency is over 3 GHz (for E5071B only))^{*1}

Max power setting	Auto selected power range	Source attenuator	Available power level																									
			-55	-50	-45	-40	-35	-30	-25	-20	-15	-10	-5	0	5	10	[/dBm]											
0 < Max power ≤ +10 dBm	-20 ~ +10 dBm	0 dB																										
-5 < Max power ≤ 0 dBm	-25 ~ +7 dBm	5 dB																										
-10 < Max power ≤ -5 dBm	-30 ~ +2 dBm	10 dB																										
-15 < Max power ≤ -10 dBm	-35 ~ -3 dBm	15 dB																										
-20 < Max power ≤ -15 dBm	-40 ~ -8 dBm	20 dB																										
-25 < Max power ≤ -20 dBm	-45 ~ -13 dBm	25 dB																										
-30 < Max power ≤ -25 dBm	-50 ~ -18 dBm	30 dB																										
-55 < Max power ≤ -30 dBm	-55 ~ -23 dBm	35 dB																										

e5070bue0102

Setting the level

- Step 1.** Press Channel Next or Channel Prev to select the channel for which you want to set the power level.
- Step 2.** Press Sweep Setup.
- Step 3.** Press **Power**.
- Step 4.** Press **Port Couple** and select the on/off setting of the level coupling for all ports.

ON	The same power level is outputted to all ports.
OFF	A specific power level is outputted to each port independently.

NOTE The power level of port 1 is coupled with the power level for all ports.

NOTE If you change the on/off setting of the level coupling, all ports are automatically changed to the same level value as that of port 1.

Step 5. When setting level for all ports (Port Couple ON)

- 1. Press **Power**.
- 2. Enter the power level using the ENTRY block keys on the front panel.

When setting level for each port (Port Couple OFF)

- 1. Press **Port Power**.
- 2. Press the softkey corresponding to each port (**Port 1 Power** to **Port 4 Power**).

*1. The available power level over 3 GHz changes according to measurement frequencies.

Setting Measurement Conditions

Setting Stimulus Conditions

3. Enter the power level using the ENTRY block keys on the front panel.

Correcting attenuation of power level (using power slope feature)

You can use the power slope feature to correct the attenuation of a power level so that it is simply proportional to the frequency (attenuation due to cables and so on), which improves the accuracy of the level actually applied to the DUT.

Turning power slope feature on/off

Step 1. Press **Channel Next** or **Channel Prev** to select the channel for which the power slope feature will be turned on or off.

Step 2. Press **Sweep Setup**.

Step 3. Press **Power**.

Step 4. Press **Slope [OFF] (Slope [ON])**. Each press toggles between on/off.

Setting correction coefficient (correction amount for 1 GHz)

Step 1. Press **Channel Next** or **Channel Prev** to select the channel for which you want to set the correction coefficient.

Step 2. Press **Sweep Setup**.

Step 3. Press **Power**.

Step 4. Press **Slope [xxx dB/GHz]**. “xxx” represents the current set value.

Step 5. Enter the correction coefficient using the ENTRY block keys on the front panel.

Setting power range manually

By turning off the Auto Power Range set function, you can set the power level at the frequency sweep independently for each test port manually, within the range of -20 dBm to 10 dBm (for instruments with option 214, 314, or 414, the range of -55 dBm to 10 dBm) and at a resolution of 0.05 dB.

Selecting range

When option 214, 314, or 414 is installed, you can select from the following power ranges.

Selectable power ranges	
-20 dBm to 10 dBm	-25 dBm to 7 dBm
-30 dBm to 2 dBm	-35 dBm to -3 dBm
-40 dBm to -8 dBm	-45 dBm to -13 dBm
-50 dBm to -18 dBm	-55 dBm to -23 dBm

NOTE

The range selection is common to all ports: You cannot select it for each port independently.

The procedure for selecting the range is as follows:

- Step 1.** Press **Channel Next** or **Channel Prev** to select the channel for which you want to set the power range.
- Step 2.** Press **Sweep Setup**.
- Step 3.** Press **Power**.
- Step 4.** Turn OFF **Auto Range**.
- Step 5.** Press **Power Ranges**.
- Step 6.** Press the desired softkey to select the power range.

Setting the number of points

The number of points is the number of data items collected in one sweep. It can be set to any number from 2 to 1601 for each channel independently.

- To obtain a higher trace resolution against the stimulus value, choose a larger number of points.
- To obtain higher throughput, keep the number of points to a smaller value within an allowable trace resolution.
- To obtain higher measurement accuracy after calibration, perform calibration using the same number of points as in actual measurements.

NOTE

When the upper limit of the number of channels and traces is set to **1Ch / 4 Tr 20001 Points** in Channel/Trace Setup, the maximum number of measurement points will be 20001.

Setting the number of points

- Step 1.** Press **Channel Next** or **Channel Prev** to select the channel for which the number of points will be set.
- Step 2.** Press **Sweep Setup**.
- Step 3.** Press **Points**.
- Step 4.** Using the ENTRY block keys on the front panel, input the desired number of points.

Setting the sweep time

Sweep time is the time it takes to complete a sweep for each stimulus (source) port. Two modes are available for setting the sweep time: manual sweep time mode and automatic sweep time mode.

Manual Sweep Time Mode

In this mode, the sweep time is set manually. Once the sweep time is set, changes in measurement conditions will not affect the sweep time as long as it is within the analyzer's capability. If the sweep time becomes lower than the analyzer's lower sweep time limit, the sweep time will be reset to the shortest time within the conditions. If the sweep time exceeds the analyzer's upper sweep time limit, the sweep time will be reset to the longest time within the conditions.

Automatic Sweep Time Mode

The sweep time is always kept to the shortest time possible with the current measurement conditions.

Figure 3-7 shows the definitions of the sweep time and the sweep delay time.

Figure 3-7 Sweep Time and Sweep Delay Time

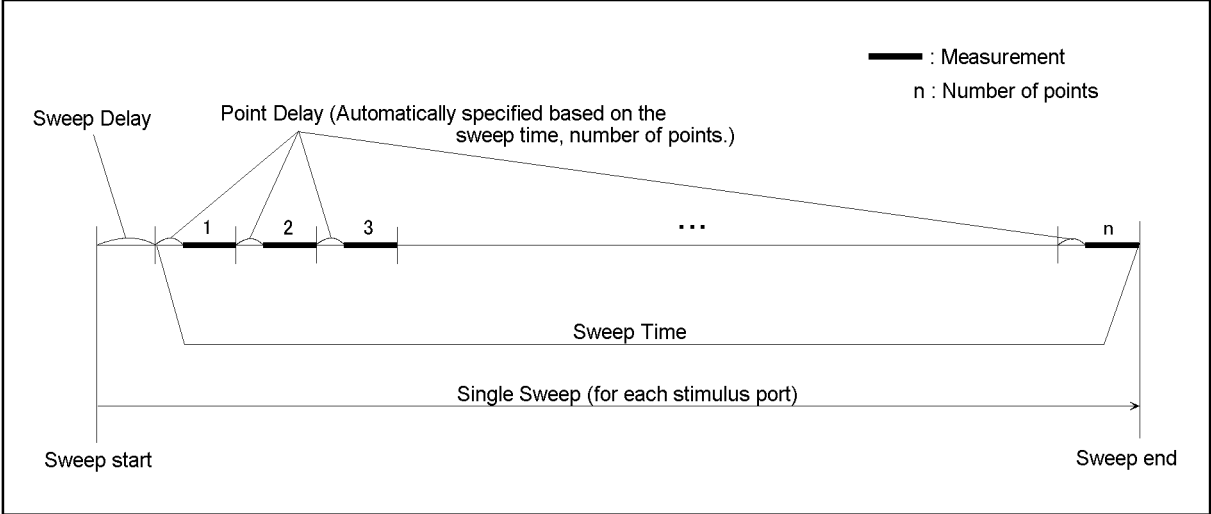

e5070aue119

Sweep delay is time before starting a sweep for each stimulus (source) port

Setting Up the Sweep Time (Manual Sweep Time Mode)

- Step 1.** Press **Channel Next** or **Channel Prev** to select the channel for which sweep time will be set.
- Step 2.** Press **Sweep Setup**.
- Step 3.** Press **Sweep Time**.
- Step 4.** Using the ENTRY block keys on the front panel, input the desired sweep time (in seconds).

If the previous operation mode was automatic sweep time mode, entering a new sweep time forces the machine to switch to manual sweep time mode.

Switching to Automatic Sweep Time Mode

- Step 1.** Press **Channel Next** or **Channel Prev** to select the channel which will be switched to automatic sweep time mode.
- Step 2.** Press **Sweep Setup**.
- Step 3.** Press **Sweep Time**.
- Step 4.** Press **0** **x1**.

By entering zero (seconds), automatic sweep time becomes effective.

3. Setting Measurement Conditions

Selecting Measurement Parameters

The E5070B/E5071B allows users to evaluate the DUT (device under test) characteristics by using the following measurement parameters.

- S-parameters
- Mixed mode S-parameters

This section gives the definition of S-parameters and explains how to choose their values. For the definition and use of mixed mode S-parameters, refer to “Evaluating Balanced Devices (balance-unbalance conversion function)” on page 293.

Definition of S-parameters

S-parameters (scattering parameters) are used to evaluate how signals are reflected by and transferred through the DUT. An S-parameter is defined by the ratio of two complex numbers and contains information on the magnitude and phase of the signal. S-parameters are typically expressed as follows.

$$S_{\text{out in}}$$

out: port number of the DUT from which the signal is output

in: port number of the DUT to which the signal is input

For example, S-parameter S_{21} is the ratio of the output signal of port 2 on the DUT with the input signal of port 1 on the DUT, both expressed in complex numbers.

Setting up S-parameters

Step 1. Press **Channel Next** (or **Channel Prev**) and **Trace Next** (or **Trace Prev**) to select the trace for which measurement parameters will be set up.

Step 2. Press **Meas**.

Step 3. Press a softkey that corresponds to the desired S-parameter.

S-parameters on the softkeys are expressed as follows.

$$S_{\text{out in}}$$

out: test port number of the E5070B/E5071B to which the DUT's output signal is input

in: test port number of the E5070B/E5071B from which the signal is applied to the DUT

Selecting a Data Format

The E5070B/E5071B allows you to display measured S-parameters by using the following data formats:

- Rectangular display formats
 - Log magnitude format
 - Phase format
 - Expanded phase format
 - Positive phase format
 - Group delay format
 - Linear magnitude format
 - SWR format
 - Real format
 - Imaginary format
- Polar format
- Smith chart format

Rectangular display formats

Rectangular display formats draw traces by assigning stimulus values (linear scale) to the X-axis and response values to the Y-axis (Figure 3-8). Eight different formats are available depending on the selection of data for the Y-axis (Table 3-3).

Figure 3-8

Rectangular display format

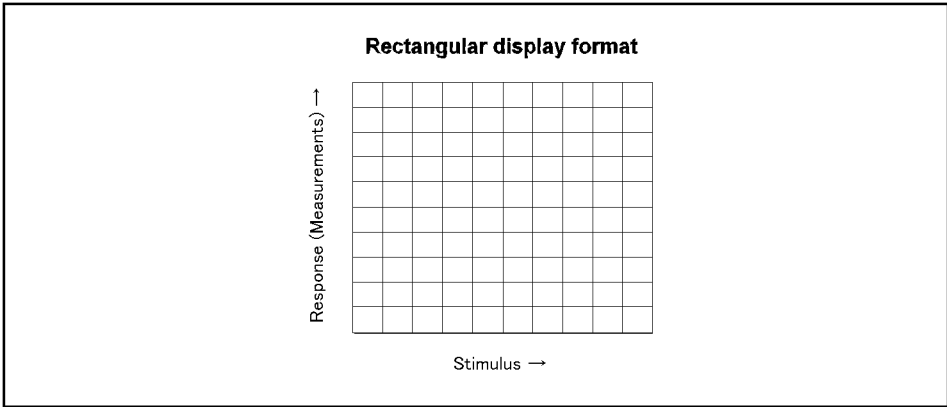

e5070bue070

Table 3-3 Eight types of rectangular display formats

Type	Y-axis Data Type	Y-axis Unit	Application Examples
Log magnitude format	Magnitude	dB	<ul style="list-style-type: none"> •Return loss measurement •Insertion loss measurement (or gain measurement)
Phase format	Phase (displayed in range from -180° to $+180^\circ$)	Degrees ($^\circ$)	•Measurement of deviation from linear phase
Expanded phase format	Phase (can be displayed above $+180^\circ$ and below -180°)	Degrees ($^\circ$)	•Measurement of deviation from linear phase
Positive phase format	Phase (displayed in range from 0° to $+360^\circ$)	Degrees ($^\circ$)	•Measurement of deviation from linear phase
Group delay format	Signal transfer delays within the DUT	Seconds (s)	•Group delay measurement
Linear magnitude format	Magnitude	(Abstract number)	•Reflection coefficient measurement
SWR format	$\frac{1 + \rho}{1 - \rho}$ (ρ : reflection coefficient)	(Abstract number)	•Measurement of standing wave ratio
Real format	Real part of measured complex parameter	(Abstract number)	
Imaginary format	Imaginary part of measured complex parameter	(Abstract number)	

Polar format

In the polar format, traces are drawn by expressing the magnitude as a displacement from the origin (linear) and phase in an angle counterclockwise from the positive X-axis. This data format does not have a stimulus axis, so frequencies must be read by using the marker. The polar format allows users to select one of the following three data groups for displaying the marker response values.

- Linear magnitude and phase ($^\circ$)
- Log magnitude and phase ($^\circ$)
- Real and imaginary parts

Figure 3-9

Polar format

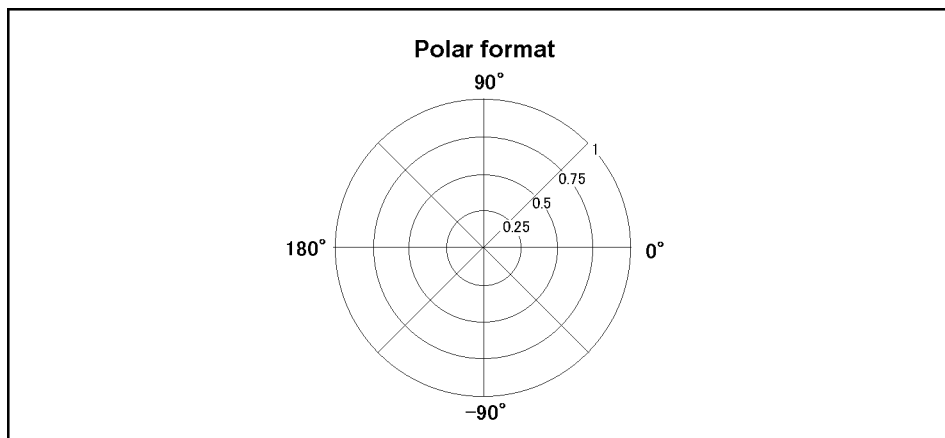

e5070aue030

Smith chart format

The Smith chart format is used to display impedances based on reflection measurement data of the DUT. In this format, traces are plotted at the same spots as in the polar format. The Smith chart format allows users to select one of the following five data groups for displaying the marker response values.

- Linear magnitude and phase ($^{\circ}$)
- Log magnitude and phase ($^{\circ}$)
- Real and imaginary parts
- Resistance (Ω), reactance (Ω), and inductance (H) or capacitance (F)
- Conductance (S), susceptance (S), and capacitance (F) or inductance (H)

Figure 3-10

Smith chart format

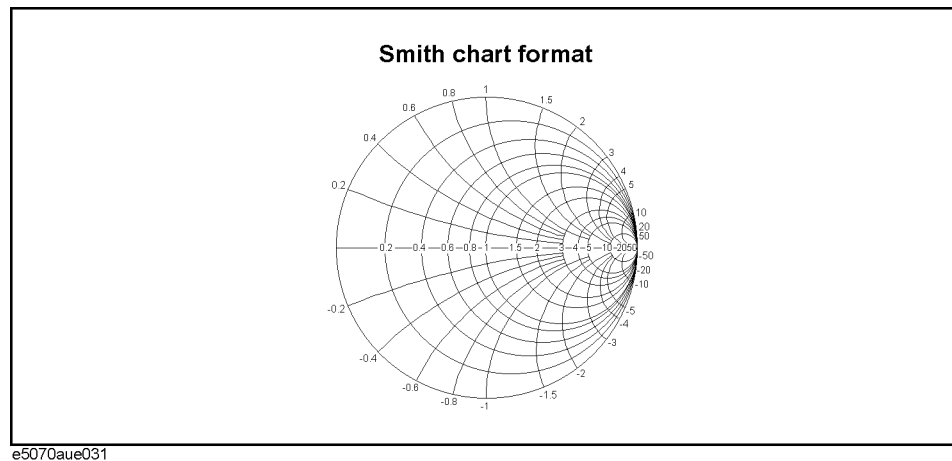

Setting Measurement Conditions

Selecting a Data Format

Selecting a data format

Use the following procedure to select a data format.

- Step 1.** Press **Channel Next** (or **Channel Prev**) and **Trace Next** (or **Trace Prev**) to select the trace for which the data format will be set.
- Step 2.** Press **Format**.
- Step 3.** Press the softkey that corresponds to the desired data format.

Softkey	Function
Log Mag	Selects the log magnitude format
Phase	Selects the phase format
Group Delay	Selects the group delay format
Smith - Lin / Phase	Selects the Smith chart format (with linear magnitude and phase as the marker response values)
Smith - Log / Phase	Selects the Smith chart format (with log magnitude and phase as the marker response values)
Smith - Real / Imag	Selects the Smith chart format (with the real and imaginary parts as the marker response values)
Smith - R + jX	Selects the Smith chart format (with resistance and reactance as the marker response values)
Smith - G + jB	Selects the Smith chart format (with conductance and susceptance as the marker response values)
Polar - Lin / Phase	Selects the polar format (with linear magnitude and phase as the marker response values)
Polar - Log / Phase	Selects the polar format (with log magnitude and phase as the marker response values)
Polar - Real / Imag	Selects the polar format (with the real and imaginary parts as the marker response values)
Lin Mag	Selects the linear magnitude format
SWR	Selects the SWR (standing wave ratio) format
Real	Selects the real format
Imaginary	Selects the imaginary format
Expand Phase	Selects the expanded phase format
Positive Phase	Selects the positive phase format

Setting the Scales

Auto scale

The auto scale function is used to tailor each scale (scale/division and the reference line value) automatically in such a way that traces will appear at the proper size on the screen for easy observation.

Single Trace Auto Scale

Follow the procedure below to perform the auto scale function on a specific trace.

- Step 1.** Press **Channel Next** (or **Channel Prev**) and **Trace Next** (or **Trace Prev**) to select the trace for which the auto scale function will be performed.
- Step 2.** Press **Scale**.
- Step 3.** Press **Auto Scale**.

Auto Scale on All Traces Within a Channel

- Step 1.** Press **Channel Next** (or **Channel Prev**) to select the channel for which the auto scale function will be performed.
- Step 2.** Press **Scale**.
- Step 3.** Press **Auto Scale All**.

Manual scale adjustment on a rectangular display format

For a rectangular display format, four parameters are used to manually adjust the scales (Table 3-3 and Figure 3-11).

Table 3-4

Adjustable scale features on a rectangular display format

Adjustable feature	Description
Divisions (Divisions)	Defines the number of divisions on the Y-axis. An even number from 4 to 30 must be used. Once set, it is commonly applied to all traces displayed in any rectangular format within that channel.
Scale/Division (Scale/Div)	Defines the number of increments per division on the Y-axis. The value applies only to the active trace.
Reference position (Reference Position)	Defines the position of the reference line. The position must be specified using the number assigned to each division on the Y-axis starting at 0 (the least significant) running up to the number of divisions being used (the most significant). The position applies only to the active trace.
Reference line value (Reference Value)	Defines the value corresponding to the reference line. It must be set using the unit on the Y-axis. The reference line value applies only to the active trace.

Figure 3-11

Manual scale setup on a rectangular display format

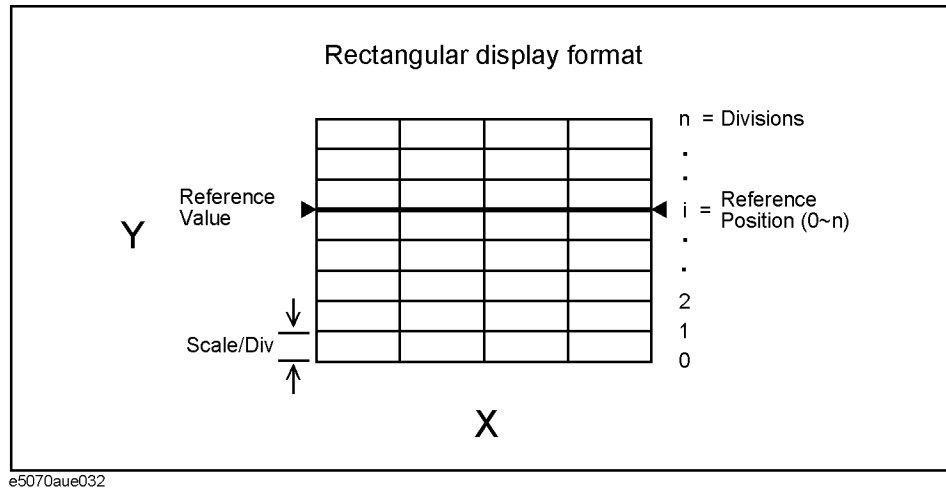

Manually setting scales on a rectangular display format

- Step 1.** Press **Channel Next** (or **Channel Prev**) and **Trace Next** (or **Trace Prev**) to select the trace for which scale features will be adjusted.
- Step 2.** Press **Scale**.
- Step 3.** Press the softkey that corresponds to the particular feature that needs to be adjusted.

Softkey	Function
Divisions	Defines the number of divisions on the Y-axis.
Scale/Div	Defines the number of increments per division on the Y-axis.
Reference Position	Defines the position of the reference line.
Reference Value	Defines the value corresponding to the reference line.

NOTE

It is also possible to turn off the display of graticule labels. For details, refer to “Turning off the display of graticule labels” on page 88.

Manual scale adjustment on the Smith chart/polar format

Manual scale adjustment on the Smith chart format or the polar format is done by using the displacement (Scale/Div of the outermost circle, Figure 3-12).

Figure 3-12

Manual scale setup on the Smith chart/polar format

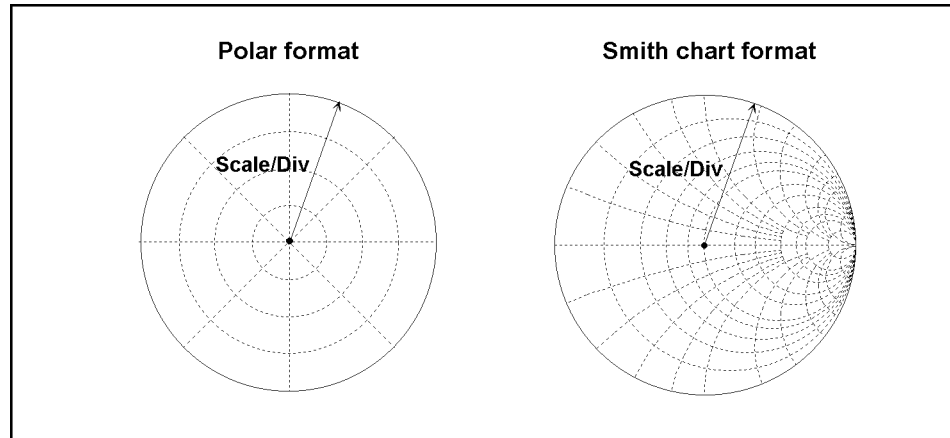

Manually setting scales on the Smith chart/polar format

- Step 1.** Press **Channel Next** (or **Channel Prev**) and **Trace Next** (or **Trace Prev**) to select the trace for which the scale will be adjusted.
- Step 2.** Press **Scale**.
- Step 3.** Press **Scale/Div**.
- Step 4.** Using the ENTRY block keys on the front panel, input the displacement of the outermost circle.

Setting the value of a reference line using the marker

When using a rectangular display format, it is possible to change the reference line value to be equal to the response value of the active marker on the active trace.

Setting the reference line value using the marker

- Step 1.** Place the active marker on the active trace on the position that corresponds to the new reference line value.
- Step 2.** Press **Scale** or **Marker Fctn**.
- Step 3.** Press **Marker** → **Reference** to change the reference line value to the marker response value.

NOTE

If the reference marker is on and the stimulus value of the active marker is expressed using a value relative to the reference marker, the absolute stimulus value will be used to set the new reference line value.

Setting Window Displays

Maximizing the specified window/trace display

When using multiple channels, it is possible to maximize a specific channel window on the screen. When multiple traces are displayed in a channel window, it is also possible to maximize a specific trace displayed within that channel window.

Maximizing a window

Step 1. Press **Channel Next** (or **Channel Prev**) to select the channel whose window will be maximized.

Step 2. Press **Channel Max** to maximize the channel window.

Press **Channel Max** one more time to reduce the window to its previous size.

Maximizing a trace display

Step 1. Press **Channel Next** (or **Channel Prev**) to select the channel to which the trace belongs.

Step 2. Press **Trace Next** (or **Trace Prev**) to select the trace whose display will be maximized.

Step 3. Press **Trace Max** to maximize the trace display.

Press **Trace Max** one more time to reduce the display to its previous size.

Turning off the display of graticule labels

When using a rectangular display format, the graph area can be expanded to the left by turning off the display of graticule labels.

Turning off graticule label display

Step 1. Press **Channel Next** (or **Channel Prev**) to select the channel for which graticule label display will be turned on or off.

Step 2. Press **Display**.

Step 3. Press **Graticule Label** to turn graticule label display on or off.

Hiding Frequency Information

You can hide the frequency information from the screen in order to ensure its confidentiality or for other reasons.

Hiding Frequency Information on the Screen

Follow the steps below to hide frequency information on the measurement screen.

- Step 1.** Press **Display**.
- Step 2.** Press **Frequency** turn off the frequency display.

NOTE

Turning off the frequency display using the **Frequency** key does not erase the frequency display within the Stimulus softkey, which is turned on by pressing **Start**, **Stop**, **Center**, and **Span**. The display of the softkey bar itself can be switched on or off by pressing **Softkey On/Off**.

Hiding Softkey's Frequency Information

You can delete the frequency information from the measurement screen, which changes the frequency information displayed in the Stimulus softkey and the data entry area for Hz unit to asterisks (***)

- Step 1.** Press **System** - **Service Menu**.
- Step 2.** Press Security Level and select any of the following options for the frequency display.

Softkey	Function
OFF	Displays the frequency information.
Low	Hides the frequency information with a series of asterisks. This can be turned to OFF by the Security Level menu.
High	Hides the frequency information with a series of asterisks. This cannot be turned to OFF by the Security Level menu. Resetting to OFF is only possible by executig Preset or Recall.

Labeling a window

It is possible to assign a unique name to a channel and display it on the screen. This feature is useful in saving and/or printing measurement result for future reference.

Labeling a window

- Step 1.** Press **Channel Next** or **Channel Prev** to select the channel to be labeled.
- Step 2.** Press **Display**.
- Step 3.** Press **Edit Title Label**.

The title label input dialog box (see Figure 3-13) appears.

Setting Measurement Conditions
Setting Window Displays

Figure 3-13

Title label input dialog box



- Step 4.** Using the keys in the dialog box, type a label and press **Enter**.
- Step 5.** Press **Title Label** to turn on the title display.

The title will appear within a frame at the top of the channel window (title bar, Figure 3-14.)

Figure 3-14

Title Display

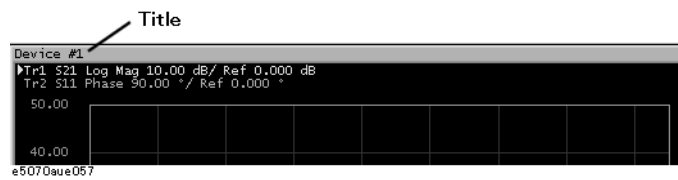

Setting display colors

Selecting display mode

You can select the display mode of the LCD display from two modes: normal display (background: black) or inverted display (background: white). In normal display, the colors of items are preset so that you can recognize them easily on the display of the instrument. On the other hand, in inverted display, they are preset to colors obtained by nearly inverting the default settings of the normal display so that you can use data easily when storing it into a graphic file.

The selection procedure is as follows:

- Step 1.** Press **Display**.
- Step 2.** Press **Invert Color** to select the display color. OFF indicates the normal display; ON the inverted display.

Setting display color for each item

You can set the display color to the normal display or the inverted display separately for each of the following items.

- Data/memory trace
- Labels and lines of graphs
- File display of the limit test and limit lines
- Background

You set the color of each item by specifying the amounts of red (R), green (G), and blue (B) contained in the color. You can specify each level of R, G, and B in 6 steps (0 to 5). Therefore, 216 colors in total are available by combining them. The table below shows the R, G, and B values for the main colors as a reference.

	R	G	B		R	G	B		R	G	B
White	5	5	5	Gray	2	2	2	Black	0	0	0
Light red	5	3	3	Red	5	0	0	Dark red	2	0	0
Light yellow	5	5	3	Yellow	5	5	0	Dark yellow	2	2	0
Light green	3	5	3	Green	0	5	0	Dark green	0	2	0
Light cyan	3	5	5	Cyan	0	5	5	Dark cyan	0	2	2
Light blue	3	3	5	Blue	0	0	5	Dark blue	0	0	2
Light magenta	5	3	5	Magenta	5	0	5	Dark magenta	2	0	2

The setting procedure is as follows:

- Step 1.** Press **System**.
- Step 2.** Press **Misc Setup**.
- Step 3.** Press **Color Setup**.
- Step 4.** Press **Normal** (for normal display) or **Invert** (for inverted display).

Setting Measurement Conditions

Setting Window Displays

Step 5. Press the softkey corresponding to the item for which you want to set the display color.

Softkey	Function
Data Trace 1 to 9	Specifies the data trace of traces 1 to 9
Mem Trace 1 to 9	Specifies the memory trace of traces 1 to 9
Graticule Main	Specifies the graticule label and the outer lines of graphs
Graticule Sub	Specifies the grid of graphs
Limit Fail	Specifies the fail display in the limit test result
Limit Line	Specifies the limit line
Background	Specifies the background

Step 6. Press **Red**.

Step 7. Select the amount of red (R) from **0** to **5**.

Step 8. Press **Green**.

Step 9. Select the amount of green (G) from **0** to **5**.

Step 10. Press **Blue**.

Step 11. Select the amount of blue (B) from **0** to **5**.

Resetting the display colors to the factory state

You can reset the display colors in normal display and inverted display to the preset factory state.

The selection procedure is as follows:

Step 1. Press **[System]**.

Step 2. Press **Misc Setup**.

Step 3. Press **Color Setup**.

Step 4. Press **Normal** (for normal display) or **Invert** (for inverted display).

Step 5. Press **Reset Color**.

Step 6. Press **OK**.

4 Calibration

This chapter describes the calibration processes that should be used with the Agilent E5070B/E5071B.

Measurement Errors and their Characteristics

It is important to understand the factors contributing to measurement errors in order to determine the appropriate measures that should be taken to improve accuracy.

Measurement errors are classified into three categories:

- Drift errors
- Random errors
- Systematic errors

Drift Errors

Drift errors are caused by deviations in the performance of the measuring instrument (measurement system) that occur after calibration. Major causes are the thermal expansion of connecting cables and thermal drift of the frequency converter within the measuring instrument. These errors may be reduced by carrying out frequent calibrations as the ambient temperature changes or by maintaining a stable ambient temperature during the course of a measurement.

Random Errors

Random errors occur irregularly in the course of using the instrument. Since random errors are unpredictable, they cannot be eliminated by calibration. These errors are further classified into the following sub-categories depending on their causes.

- Instrument noise errors
- Switch repeatability errors
- Connector repeatability errors

Instrument noise errors

Instrument noise errors are caused by electric fluctuations within components used in the measuring instrument. These errors may be reduced by increasing the power of the signal supplied to the DUT, narrowing the IF bandwidth, or enabling sweep averaging.

Switch repeatability errors

Switch repeatability errors occur due to the fact that the electrical characteristics of the mechanical RF switch used in the measuring instrument change every time it is switched on. These errors may be reduced by carrying out measurements under conditions in which no switching operation takes place.

(You don't need to worry about these errors since the E5070B/E5071B does not have mechanical RF switches).

Connector repeatability errors

Connector repeatability errors are caused by fluctuations in the electrical characteristics of connectors due to wear. These errors may be reduced by handling connectors with care.

Systematic Errors

Systematic errors are caused by imperfections in the measuring instrument and the test setup (cables, connectors, fixtures, etc.). Assuming that these errors are repeatable (i.e., predictable) and their characteristics do not change over time, it is possible to eliminate them mathematically at the time of measurement by determining the characteristics of these errors through calibration. There are six types of systematic errors, as follows.

Errors caused by signal leaks in the measuring system:

- Directivity
- Isolation (cross-talk)

Errors caused by reflections in the measuring system:

- Source match
- Load match

Errors caused by the frequency response of the receiver within the measuring instrument:

- Reflection tracking
- Transmission tracking

The E5070B/E5071B has two receivers for each test port the reference receiver and the test receiver (transmission measurement or reflection measurement). You can perform measurements with both of these receivers at the same time. Figure 4-1 shows the architecture of the test ports of the E5070B/E5071B and systematic errors.

Figure 4-1 E5070B/E5071B port architecture and systematic errors

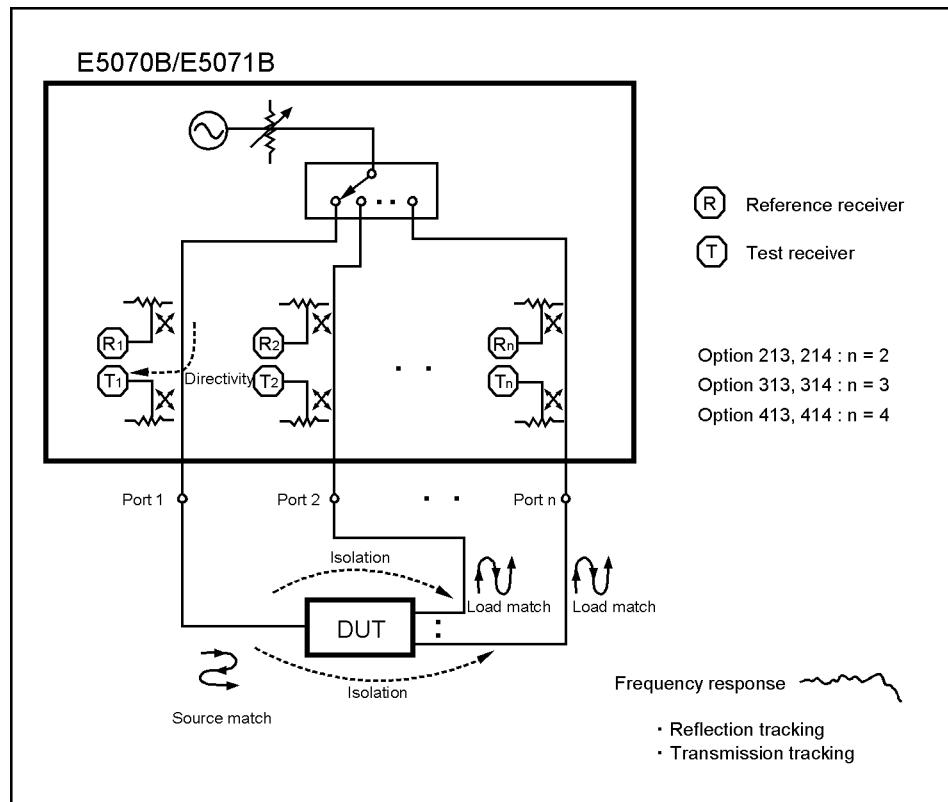

e5070bue007

Directivity error (Ed)

Directivity errors are caused by the fact that, in a reflection measurement, signals other than the reflection signal from the DUT are received by receiver T1 (Figure 4-1) through the directivity coupler. When a certain port is a stimulus port, this error can be defined as a constant value for each stimulus port because the state of the termination at the other ports does not change. The number of directivity errors of the E5070B/E5071B is the number of stimulus ports you use.

Ed1	Directivity error of port 1
Ed2	Directivity error of port 2
Ed3 ^{*1}	Directivity error of port 3
Ed4 ^{*2}	Directivity error of port 4

*1. Options 313, 314, 413, and 414 only

*2. Options 413 and 414 only

Isolation error (Ex)

An isolation error (crosstalk error) is caused by signals other than the transmission signal of the DUT leaking to the test receiver of the transmission measurement port in transmission measurements. When a certain port is a stimulus port, an isolation error is defined for each of the other ports. Therefore, the number of isolation errors for the E5070B/E5071B is the total number of combinations of stimulus ports and response ports.

Ex21, Ex31 ^{*1} , and Ex41 ^{*2}	Isolation error when port 1 is a stimulus port
Ex12, Ex32 ^{*1} , and Ex42 ^{*2}	Isolation error when port 2 is a stimulus port
Ex13 ^{*1} , Ex23 ^{*1} , and Ex43 ^{*2}	Isolation error when port 3 is a stimulus port
Ex14 ^{*2} , Ex24 ^{*2} , and Ex34 ^{*2}	Isolation error when port 4 is a stimulus port

*1. Options 313, 314, 413, and 414 only

*2. Options 413 and 414 only

Source match error (Es)

A source match error is caused when the reflection signal of the DUT reflects at the signal source and enters the DUT again. When a certain port is a stimulus port, this error can be defined as a constant value for each stimulus port because the state of the signal source switch does not change. The number of source match errors in the E5070B/E5071B is equivalent to the number of stimulus ports you use.

Es1	Source match error of port 1
Es2	Source match error of port 2
Es3 ^{*1}	Source match error of port 3
Es4 ^{*2}	Source match error of port 4

- *1. Options 313, 314, 413, and 414 only
- *2. Options 413 and 414 only

Load match error (EI)

A load match error is caused when part, but not all, of the signal transmitted in the DUT reflects at a response port is measured by the receiver of the response port. When a certain port is a stimulus port, a load match error is defined for each of the other ports. Therefore, the number of load match errors for the E5070B/E5071B is the total number of combinations of stimulus ports and response ports.

EI21, EI31 ^{*1} , and EI41 ^{*2}	Load match error when port 1 is a stimulus port
EI12, EI32 ^{*1} , and EI42 ^{*2}	Load match error when port 2 is a stimulus port
EI13 ^{*1} , EI23 ^{*1} , and EI43 ^{*2}	Load match error when port 3 is a stimulus port
EI14 ^{*2} , EI24 ^{*2} , and EI34 ^{*2}	Load match error when port 4 is a stimulus port

- *1. Options 313, 314, 413, and 414 only
- *2. Options 413 and 414 only

Reflection tracking error (Er)

A reflection tracking error is caused by the difference in frequency response between the test receiver and the reference receiver of a stimulus port in reflection measurements. This error can be defined as a constant value for each stimulus port because the combination of the test receiver and the reference receiver of a stimulus port is always the same. The number of reflection tracking errors for the E5070B/E5071B is simply the number of stimulus ports you use.

Er1	Reflection tracking error of port 1
Er2	Reflection tracking error of port 2
Er3 ^{*1}	Reflection tracking error of port 3
Er4 ^{*2}	Reflection tracking error of port 4

- *1. Options 313, 314, 413, and 414 only
- *2. Options 413 and 414 only

Transmission tracking error (Et)

A transmission tracking error is caused by the difference in frequency response between the test receiver of a response port and the reference receiver of a stimulus port in transmission measurements. When a certain port is a stimulus port, a transmission tracking error is defined for each of the other ports. Therefore, the number of transmission tracking errors for the E5070B/E5071B is the total number of combinations of stimulus ports and response ports.

Et21, Et31^{*1}, and Et41^{*2} Transmission tracking error when port 1 is a stimulus port

Et12, Et32^{*1}, and Et42^{*2} Transmission tracking error when port 2 is a stimulus port

Et13^{*1}, Et23^{*1}, and Et43^{*2} Transmission tracking error when port 3 is a stimulus port

Et14^{*2}, Et24^{*2}, and Et34^{*2} Transmission tracking error when port 4 is a stimulus port

*1. Options 313, 314, 413, and 414 only

*2. Options 413 and 414 only

Calibration Types and Characteristics

Table 4-1 shows the different types of calibrations and the features of each method.

Table 4-1 Calibration Types and Characteristics

Calibration Method	Standard(s) Used	Corrected Error Factor	Measurement Parameters	Characteristics
No calibration	None	None	All parameters	<ul style="list-style-type: none"> • Low accuracy • Calibration not required
Response Calibration *1	<ul style="list-style-type: none"> •OPEN or SHORT*2 •LOAD*3 	Following 2 error terms: <ul style="list-style-type: none"> •Reflection Tracking (Er) •Directivity (Ed)*3 	S11 (Reflection characteristics at 1 port)	<ul style="list-style-type: none"> •Medium-level accuracy •Quick calibration •Isolation calibration improves the accuracy in a reflection measurement of a DUT with high return loss
	<ul style="list-style-type: none"> •THRU •LOAD*3 	Following 2 error terms: <ul style="list-style-type: none"> •Transmission Tracking (Et) •Isolation (Ex)*3 	S21 (1 direction transmission characteristics at 2 ports)	<ul style="list-style-type: none"> •Medium-level accuracy •Quick calibration •Isolation calibration improves the accuracy in a transmission measurement of a device with high insertion loss
1-Port Calibration	ECal module (2-port/4-port)	Following 3 error terms: <ul style="list-style-type: none"> •Directivity (Ed) •Source Match (Es) •Reflection Tracking (Er) 	S11 (Reflection characteristics at 1 port)	<ul style="list-style-type: none"> •1-port measurement with the highest degree of accuracy •Quick calibration with low chance of operator error
	<ul style="list-style-type: none"> •OPEN •SHORT •LOAD 			<ul style="list-style-type: none"> •Highly accurate 1-port measurement
Full 2-Port Calibration *1	ECal module (2-port/4-port)	Following 12 error terms: <ul style="list-style-type: none"> •Directivity (Ed1,Ed2) •Isolation (Ex21,Ex12)*3 •Source Match (Es1,Es2) •Load Match (El12,El21) •Transmission Tracking (Et21,Et12) •Reflection Tracking (Er1,Er2) 	S11,S21,S12,S22 (All S-parameters at 2 ports)	<ul style="list-style-type: none"> •Highly accurate 2-port measurement*4 •Quick calibration with low chance of operator error
	<ul style="list-style-type: none"> •OPEN •SHORT •LOAD •THRU 			<ul style="list-style-type: none"> •Highly accurate 2-port measurement*4
Full 3-Port Calibration *5*1	ECal module (2-port*6/4-port)	Following 27 error terms: <ul style="list-style-type: none"> •Directivity (Ed1,Ed2,Ed3) •Isolation (Ex21,Ex31,Ex12,Ex32,Ex13,Ex23)*3 •Source Match (Es1,Es2,Es3) •Load Match (El21,El31,El12,El32,El13,El23) •Transmission Tracking (Et21,Et31,Et12,Et32,Et13,Et23) •Reflection Tracking (Er1,Er2,Er3) 	S11,S21,S31,S12,S22,S32,S13,S23,S33 (All S-parameters at 3 ports)	<ul style="list-style-type: none"> •Highly accurate 3-port measurement*4 •Quick calibration with low chance of operator error
	<ul style="list-style-type: none"> •OPEN •SHORT •LOAD •THRU 			<ul style="list-style-type: none"> •Highly accurate 3-port measurement*4

Calibration
Calibration Types and Characteristics

Table 4-1 Calibration Types and Characteristics

Calibration Method	Standard(s) Used	Corrected Error Factor	Measurement Parameters	Characteristics
Simplified full 3-port calibration ^{*5*1}	<ul style="list-style-type: none"> •Open •Short •Load •Thru 	Same as full 3-port calibration	S11, S21, S31, S12, S22, [S32], S13, [S23], S33 (Part of thru measurement can be skipped)	<ul style="list-style-type: none"> •High-accuracy 3-port measurement ^{*7*4} •Simpler procedure by skipping thru measurement
Full 4-Port Calibration ^{*8*1}	ECal module (2-port ^{*6/} 4-port)	Following 48 error terms: <ul style="list-style-type: none"> •Directivity (Ed1,Ed2,Ed3,Ed4) •Isolation (Ex21,Ex31,Ex41,Ex12,Ex32,Ex42,Ex13,Ex23,Ex43,Ex14,Ex24,Ex34) ^{*3} •Source Match (Es1,Es2,Es3,Es4) •Load Match (El1,El2,El3,El4) •Transmission Tracking (Et21,Et31,Et41,Et12,Et32,Et42,Et13,Et23,Et43,Et14,Et24,Et34) •Reflection Tracking (Er1,Er2,Er3,Er4) 	S11,S21,S31,S41,S12,S22,S32,S42,S13,S23,S33,S43,S14,S24,S34,S44 (All S-parameters at 4 ports)	<ul style="list-style-type: none"> •Highly accurate 4-port measurement ^{*4} •Quick calibration with low chance of operator error
	<ul style="list-style-type: none"> •OPEN •SHORT •LOAD •THRU 	<ul style="list-style-type: none"> •Highly accurate 4-port measurement ^{*4} 		
Simplified full 4-port calibration ^{*8*1}	<ul style="list-style-type: none"> •Open •Short •Load •Thru 	Same as full 4-port calibration	S11, S21, S31, [S41], S12, S22, [S32], [S42], S13, [S23], S33, S43, [S14], [S24], S34, S44 (Part of thru measurement can be skipped)	<ul style="list-style-type: none"> •High-accuracy 4-port measurement ^{*7*4} •Simpler procedure by skipping thru measurement
2-Port TRL Calibration	<ul style="list-style-type: none"> •Reflection (OPEN or SHORT) •THRU •LINE •MATCH 	Following 12 error terms: <ul style="list-style-type: none"> •Directivity (Ed1,Ed2) •Source Match (Es1,Es2) •Load Match (El1,El2) •Transmission Tracking (Et21,Et12) •Reflection Tracking (Er1,Er2) 	S11,S21,S12,S22 (All S-parameters at 2 ports)	<ul style="list-style-type: none"> •Highly accurate 2-port measurement •Effective for non-coaxial device measurement
3-Port TRL Calibration ^{*5}	<ul style="list-style-type: none"> •Reflection (OPEN or SHORT) •THRU •LINE •MATCH 	Following 27 error terms: <ul style="list-style-type: none"> •Directivity (Ed1,Ed2,Ed3) •Source Match (Es1,Es2,Es3) •Load Match (El21,El31,El12,El32,El13,El23) •Transmission Tracking (Et21,Et31,Et12,Et32,Et13,Et23) •Reflection Tracking (Er1,Er2,Er3) 	S11,S21,S31,S12,S22,S32,S13,S23,S33 (All S-parameters at 3 ports)	<ul style="list-style-type: none"> •Highly accurate 3-port measurement •Effective for non-coaxial device measurement

Table 4-1 Calibration Types and Characteristics

Calibration Method	Standard(s) Used	Corrected Error Factor	Measurement Parameters	Characteristics
Simplified 3-port TRL calibration *5	<ul style="list-style-type: none"> •Reflection (open or short) •Thru •Line •Match 	Same as 3-port TRL calibration	S11, S21, S31, S12, S22, [S32], S13, [S23], S33 (Part of thru (or line) and line (or match) measurement can be skipped)	<ul style="list-style-type: none"> •High-accuracy 3-port measurement *7 •Effective for non-coaxial device measurement •Simpler procedure by skipping thru/line/match measurement
4-Port TRL Calibration *8	<ul style="list-style-type: none"> •Reflection (OPEN or SHORT) •THRU •LINE •MATCH 	Following 48 error terms: <ul style="list-style-type: none"> •Directivity (Ed1,Ed2,Ed3,Ed4) •Source Match (Es1,Es2,Es3,Es4) •Load Match (El1,El2,El3,El4) •Transmission Tracking (Et21,Et31,Et41,Et12,Et32,Et42,Et13,Et23,Et43,Et14,Et24,Et34) •Reflection Tracking (Er1,Er2,Er3,Er4) 	S11,S21,S31,S41,S12,S22,S32,S42,S13,S23,S33,S43,S14,S24,S34,S44 (All S-parameters at 4 ports)	<ul style="list-style-type: none"> •Highly accurate 4-port measurement •Effective for non-coaxial device measurement
Simplified 4-port TRL calibration *8	<ul style="list-style-type: none"> •Reflection (open or short) •Thru •Line •Match 	Same as 4-port TRL calibration	S11, S21, S31, [S41], S12, S22, [S32], [S42], S13, [S23], S33, S43, [S14], [S24], S34, S44 (Part of thru (or line) and line (or match) measurement can be skipped)	<ul style="list-style-type: none"> •High-accuracy 4-port measurement *7 •Effective for non-coaxial device measurement •Simpler procedure by skipping thru/line/match measurement

- *1. The user may select whether or not to carry out isolation calibration.
- *2. A general principle is to use an open standard if the impedance of the device is larger than 50 Ω and a SHORT standard if it is less.
- *3. Only when isolation calibration is carried out. Isolation calibration is not performed when the 2-port ECal module and ECal Assistant VBA macro are used.
- *4. ECal, using the internal through, is less accurate than a mechanical through in transmission measurements if the latter is a perfect zero-length through. Otherwise, ECal is equal to or more accurate than a mechanical through, except for the mechanical TRL precision cal kits.
- *5. Only for options 313, 314, 413, and 414.
- *6. Used with the EcalAssistant VBA macro pre-installed in the E5070B/E5071B.
- *7. In the simplified calibration, because the calibration coefficients are calculated while omitting part of thru measurement data, the effect of errors when acquiring calibration data becomes larger than in the normal full 3/4-port calibration or 3/4-port TRL calibration.
- *8. Only for options 413 and 414.

Checking Calibration Status

Execution status of error correction for each channel

You can check the execution status of error correction for each channel with the error correction status.

The error correction status is indicated in the channel status bar in the lower part of the window by the symbols in the below table.

Symbol	Execution status of error correction
Cor (displayed in blue)	Error correction: On (enabled for all traces)
Cor (displayed in gray)	Error correction: On (enabled for some traces)
Off (displayed in gray)	Error correction: Off
--- (displayed in gray)	Error correction: On (no calibration data)
C? (displayed in blue)	Error correction: On (Interpolation is being executed or the IF bandwidth, power level, power range, sweep time, sweep delay time, sweep mode, or sweep type is different from that when the calibration was executed.)
C! (displayed in blue)	Error correction: On (Extrapolation is being executed.)

Execution status of error correction for each trace

You can check the status of the error correction actually executed for each trace with the trace status area.

For a trace for which error correction is executed, the applied calibration type is indicated in the trace status area by the symbols in the table below.

Symbol	Calibration type
RO	Open response calibration
RS	Short response calibration
RT	Thru response calibration
ER	Enhanced response calibration
F1	1-port calibration
F2	Full 2-port calibration/2-port TRL calibration
F3	Full 3-port calibration/3-port TRL calibration ^{*1}
F4	Full 4-port calibration/4-port TRL calibration ^{*1}

^{*1}. The simplified full 3/4-port calibration and the simplified 3/4-port TRL calibration (that acquire the calibration coefficients skipping part of measurement) are not discriminated from the normal full 3/4-port calibration and 3/4-port TRL calibration, and **F3** or **F4** is displayed.

If none of the symbols described above is displayed, error correction is not executed for the

trace.

For details on the trace status area, see “5-5. Trace Status Area” on page 48.

Acquisition status of calibration coefficient for each channel

You can check the acquisition status of the calibration coefficient for each channel with the calibration property.

The calibration property displays the acquisition status of the calibration coefficient between test ports for each channel in matrix format. Figure 4-2 shows an example of when the calibration coefficients have been acquired for the full 2-port calibration between test ports 1 and 2, the response calibration for test port 3, and the response calibration (THRU) between test ports 4 and 3.

Figure 4-2

Example of calibration property display

		Stimulus Port					
		S					
Response Port	R	1	2	3	4		
		1	F	F	-	-	E : Enhanced Response Calibration F : Full Port Calibration TRL Calibration R : Response Calibration - : Nothing
		2	F	F	-	-	
		3	-	-	R	-	
4	-	-	R	-			

e5070bue8002

NOTE

The simplified full 3/4-port calibration and the simplified 3/4-port TRL calibration are not discriminated from the normal full-port and TRL calibrations, and **F** is displayed.

Conditions for clearing already acquired calibration coefficients

In the following cases, already acquired calibration coefficients are cleared.

- o Executing preset clears all calibration coefficients.
- o If S parameters required to calculate the calibration coefficient for the specified calibration type and test ports and those required for the existing calibration coefficient overlap, executing the acquisition of the calibration coefficient (measuring necessary data and then pressing the **Done** softkey) clears the calibration coefficient for which necessary S parameters overlap. Taking Figure 4-2 as an example, if you acquire the calibration coefficient of the 1-port calibration for test port 4, neither calibration coefficient is cleared. On the other hand, if you acquire the calibration coefficient for the full 2-port calibration between test ports 2 and 3, the calibration coefficient of the full 2-port calibration between test ports 1 and 2 and that of the response calibration for test port 3 are cleared.

NOTE

An asterisk (*) may appear in the upper-right area of the softkey displayed when selecting a test port. This indicates that the existing calibration coefficient will be cleared if you select the test port and execute the acquisition of the calibration coefficient.

Procedure to turn on/off calibration property display

Follow these steps to turn on/off the calibration property display.

Calibration

Checking Calibration Status

- Step 1.** Press or to select the channel for which you want to turn on/off the calibration property display.
- Step 2.** Press .
- Step 3.** Press **Property**. Each press toggles the on/off setting.

Selecting Calibration Kit

Before executing calibration, you need to select a calibration kit.

If you use a calibration kit other than a predefined one, you need to define it. If the connector type of the standard of the calibration kit you use has polarity (the distinction between male and female), you need to change the standard class definition of the calibration kit depending on the standard you actually use. For more information, see “Changing the Calibration Kit Definition” on page 181.

NOTE

If you select a predefined calibration kit, (m) and (f) in the name (label) of the standard displayed in the softkey indicate male (m) and female (f) for the analyzer’s connector, respectively.

Follow these steps to select the calibration kit.

- Step 1.** Press **Channel Next** or **Channel Prev** to select the channel for which you want to select the calibration kit.
- Step 2.** Press **Cal**.
- Step 3.** Press **Cal Kit**.
- Step 4.** Select the calibration kit from the list below.

Softkey	Function
85033E	Selects the calibration kit “85033E”
85033D	Selects the calibration kit “85033D”
85052D	Selects the calibration kit “85052D”
85032F	Selects the calibration kit “85032F”
85032B	Selects the calibration kit “85032B”
85036B/E	Selects the calibration kit “85036B/E”
85031B	Selects the calibration kit “85031B”
85050C/D	Selects the calibration kit “85050C/D”
85052C	Selects the calibration kit “85052C”
85038A/F/M	Selects the calibration kit “85038A/F/M”
User	Selects the second user-defined calibration kit “User”

NOTE

If the name (label) of the calibration kit has been changed, the label is displayed as the softkey.

NOTE

An asterisk (*) on the upper right of the softkey corresponding to a predefined calibration kit indicates that its definition value has been changed from the factory setting by the user.

Setting the trigger source for calibration

You can set the trigger source for calibration before executing calibration.

You can select it from “Internal” or “System.” Setting it to “System” allows you to use the same trigger source setting for calibration and measurement.

You can set the trigger source for calibration (which is usually set to “Internal”) to “System,” which allows you to generate triggers at any timing from a PC for external control or from the front panel for calibration in the same way as for measurement.

The setting of the point trigger and averaging trigger is also applied to the trigger for calibration. When the trigger source for calibration is set to “System” and the trigger source for measurement is set to “External” or “Manual” with the point trigger function set to ON, a trigger is required for each measurement point during calibration. When the averaging trigger function is set to ON, the sweep is performed the number of times specified by the averaging factor for a single trigger during calibration.

NOTE

For the following types of calibration, the setting of the trigger source does not take effect. Those calibration operations are controlled by the internal trigger.

- Calibration using ECal
- Power calibration
- Receiver calibration
- Mixer converter calibration

Follow these steps to set the trigger source for calibration.

Step 1. Press .

Step 2. Press **Cal Trig Source**.

Step 3. Select the trigger source you want to use.

Softkey	Function
Internal	Selects “Internal.”
System	Selects “System.”

OPEN/SHORT Response Calibration (reflection test)

In OPEN or SHORT response calibration, calibration data are measured by connecting an OPEN or SHORT standard, respectively, to the desired test port. For frequency response, these calibrations effectively eliminate the reflection tracking error from the test setup in a reflection test using that port (Figure 4-3). It is also possible to carry out isolation calibration with a LOAD standard during OPEN/SHORT response calibration. An isolation calibration will eliminate the directivity error from the test setup in a reflection test using that port (Figure 4-4).

Figure 4-3

1-Port error model (OPEN/SHORT response)

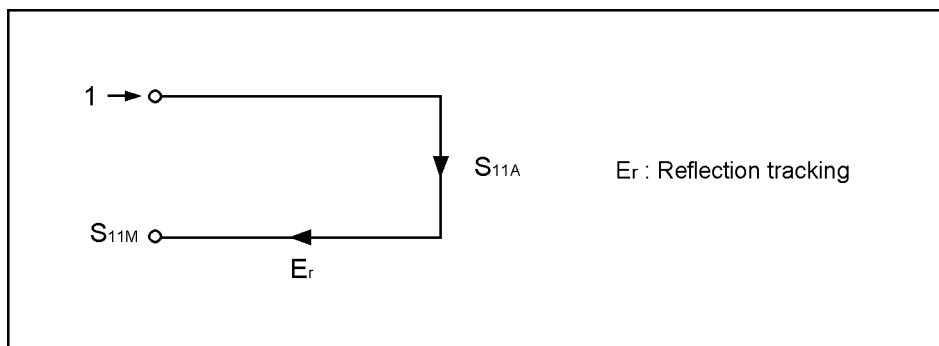

e5070aue148

Figure 4-4

1-Port error model (OPEN/SHORT response + isolation)

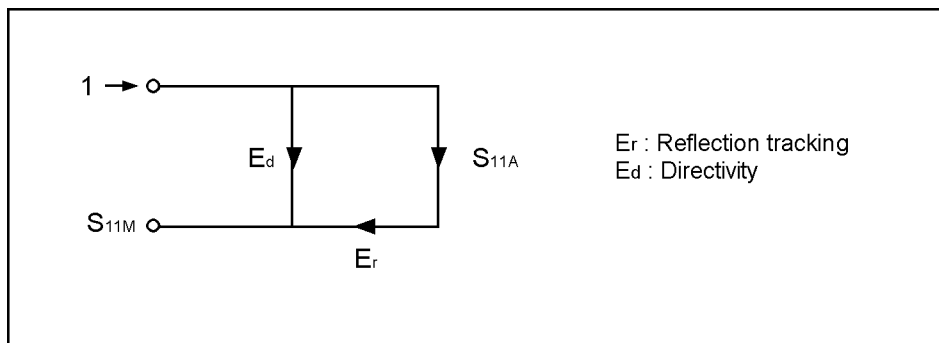

e5070aue149

Procedure

- Step 1.** Press **Channel Next** or **Channel Prev** to select the channel for which you want to perform the calibration.
- Step 2.** Press **Cal**.
- Step 3.** Press **Calibrate**.

Calibration
OPEN/SHORT Response Calibration (reflection test)

Step 4. Select OPEN or SHORT response calibration.

Softkey	Function
Response (Open)	Displays softkeys for performing an OPEN response calibration (response calibration with an OPEN standard)
Response (Short)	Displays softkeys for performing a SHORT response calibration (response calibration with a SHORT standard)

Step 5. Press **Select Port**.

Step 6. Select the test port upon which you will perform OPEN/SHORT response calibration.

Softkey	Function
1	Selects port 1
2	Selects port 2
3	Selects port 3
4	Selects port 4

NOTE

An asterisk (*) in the upper-right of the softkey indicates that the existing calibration coefficient will be cleared if you select the test port and execute the acquisition of the calibration coefficient (pressing **Done**).

Step 7. Depending on the selection made in Step 4, connect an OPEN or SHORT calibration standard to the test port (connector to which the DUT is to be connected) selected in Step 6.

Figure 4-5

Connecting the standard at OPEN/SHORT response calibration

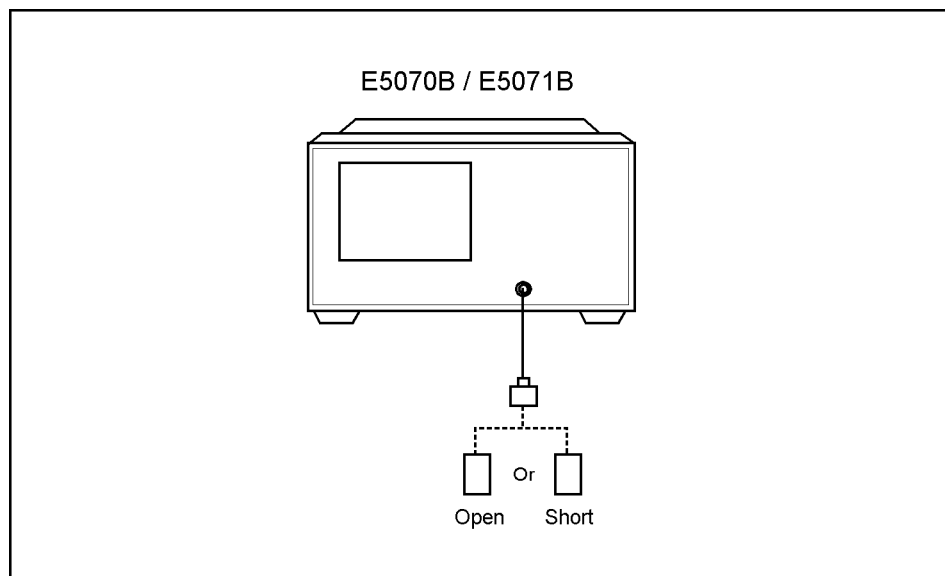

e5070bue008

- Step 8.** Press **Open** or **Short** to start the calibration measurement.
- Step 9.** If an isolation calibration must be performed using a LOAD standard, follow the procedure below.
 - a. Connect a LOAD standard to the test port (connector to which the DUT is to be connected) selected in Step 6.

Figure 4-6 **Connecting the LOAD standard**

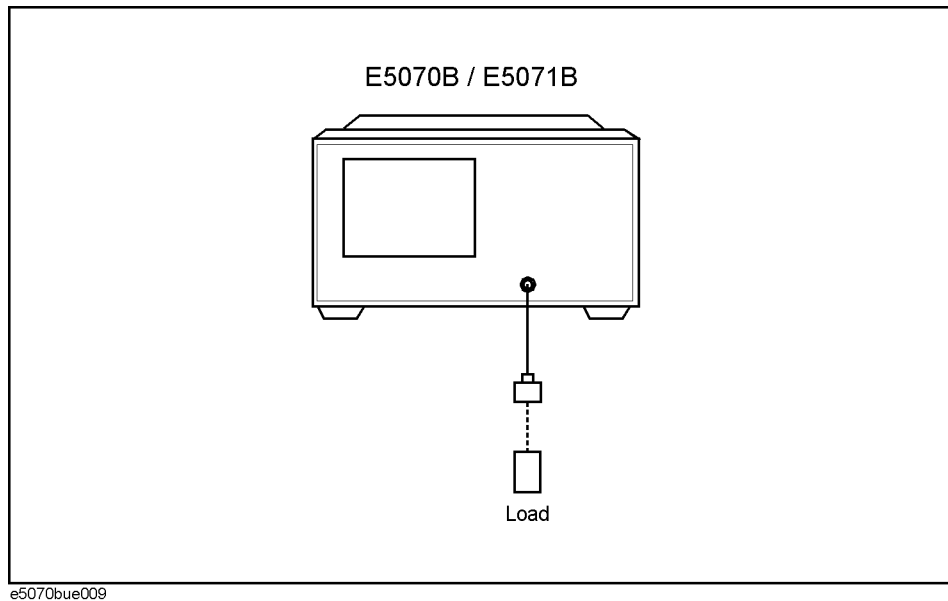

- b. Press **Load (Optional)** to start the measurement on the LOAD standard.
- Step 10.** Press **Done** to terminate the response calibration (and the LOAD isolation calibration) process. Upon pressing this key, calibration coefficients will be calculated and saved. The error correction function will also be automatically enabled.

THRU Response Calibration (transmission test)

In THRU response calibration, calibration data are measured by connecting a THRU standard to the desired test port. This calibration effectively eliminates the frequency response transmission tracking error from the test setup in a transmission test using that port (Figure 4-7). It is also possible to carry out an isolation calibration using a LOAD standard in the process of THRU response calibration. An isolation calibration will eliminate isolation error (crosstalk error) from the test setup in a transmission test using that port.

Figure 4-7

2-Port error model (THRU response)

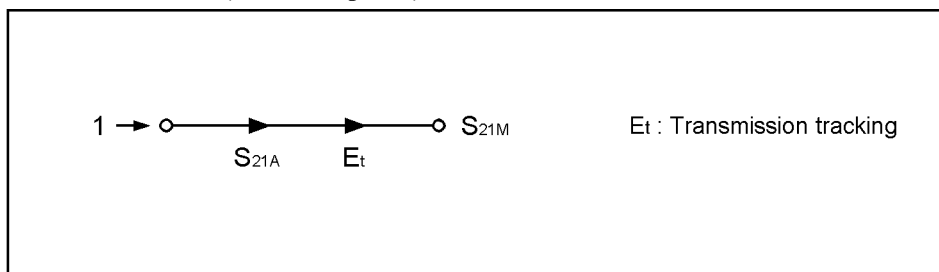

e5070aue150

Figure 4-8

2-Port Error model (THRU response + isolation)

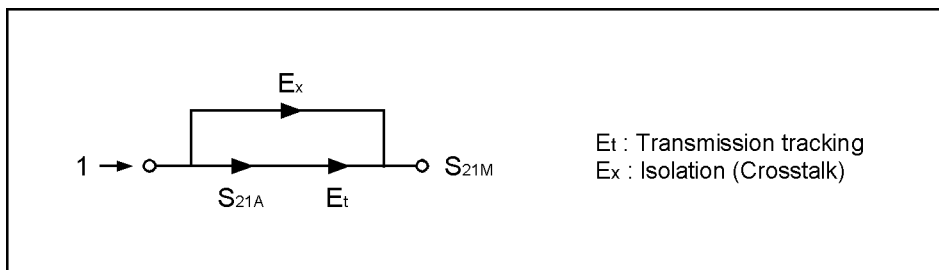

e5070aue151

Procedure

- Step 1.** Press or to select the channel for which you want to perform the calibration.
- Step 2.** Press .
- Step 3.** Press **Calibrate**.
- Step 4.** Press **Response (Thru)**.
- Step 5.** Press **Select Ports**.
- Step 6.** Select the test ports (and corresponding S parameters) upon which a THRU response calibration is to be performed.

Softkey	Function
2-1 (S21)	Selects test port 2 (input) and test port 1 (output); Corresponds to the determination of S21

Softkey	Function
3-1 (S31)	Selects test port 3 (input) and test port 1 (output); Corresponds to the determination of S31
4-1 (S41)	Selects test port 4 (input) and test port 1 (output); Corresponds to the determination of S41
1-2 (S12)	Selects test port 1 (input) and test port 2 (output); Corresponds to the determination of S12
3-2 (S32)	Selects test port 3 (input) and test port 2 (output); Corresponds to the determination of S32
4-2 (S42)	Selects test port 4 (input) and test port 2 (output); Corresponds to the determination of S42
1-3 (S13)	Selects test port 1 (input) and test port 3 (output); Corresponds to the determination of S13
2-3 (S23)	Selects test port 2 (input) and test port 3 (output); Corresponds to the determination of S23
4-3 (S43)	Selects test port 4 (input) and test port 3 (output); Corresponds to the determination of S43
1-4 (S14)	Selects test port 1 (input) and test port 4 (output); Corresponds to the determination of S14
2-4 (S24)	Selects test port 2 (input) and test port 4 (output); Corresponds to the determination of S24
3-4 (S34)	Selects test port 3 (input) and test port 4 (output); Corresponds to the determination of S34

NOTE

An asterisk (*) in the upper right of the softkey indicates that the existing calibration coefficient will be cleared if you select the test port and execute acquisition of the calibration coefficient (pressing **Done**).

Step 7. Make a THRU connection between the test ports (between the connectors to which the DUT will be connected) selected in Step 6.

Figure 4-9

Connecting at THRU response calibration

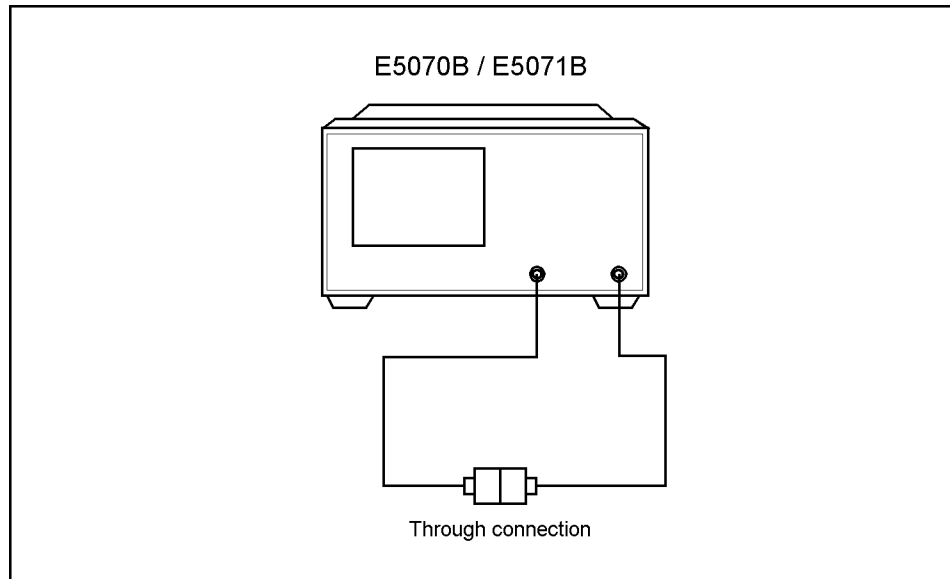

e5070bue010

Calibration

THRU Response Calibration (transmission test)

- Step 8.** Press **Thru** to start the calibration measurement.
- Step 9.** If an isolation calibration must be performed using a LOAD standard, follow the procedure below.
- Connect a LOAD standard to each of the two test ports (connectors to which the DUT is to be connected) selected in Step 6.

Figure 4-10 Connecting the LOAD standard

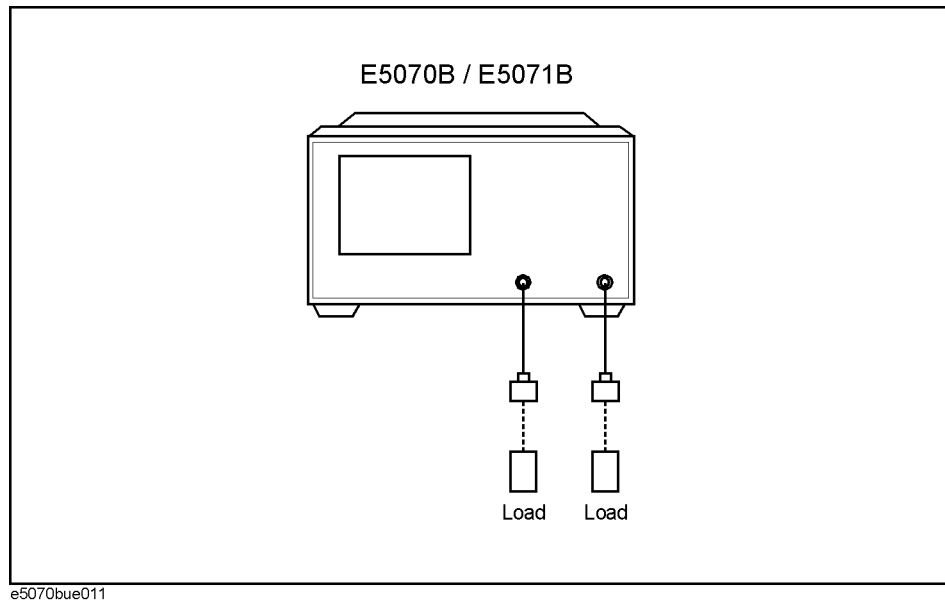

- Press **Isolation (Optional)** to start the calibration measurement.
- Step 10.** Press **Done** to terminate the response calibration (and the LOAD isolation calibration) process. Upon pressing this key, calibration coefficients will be calculated and saved. The error correction function will also be automatically enabled.

1-Port Calibration (reflection test)

In 1-port calibration, calibration data are measured by connecting an OPEN standard, a SHORT standard, and a LOAD standard to the desired test port. This calibration effectively eliminates the frequency response reflection tracking error, directivity error, and source match error from the test setup in a reflection test using that port (Figure 4-11).

Figure 4-11 1-Port error model (1-port calibration)

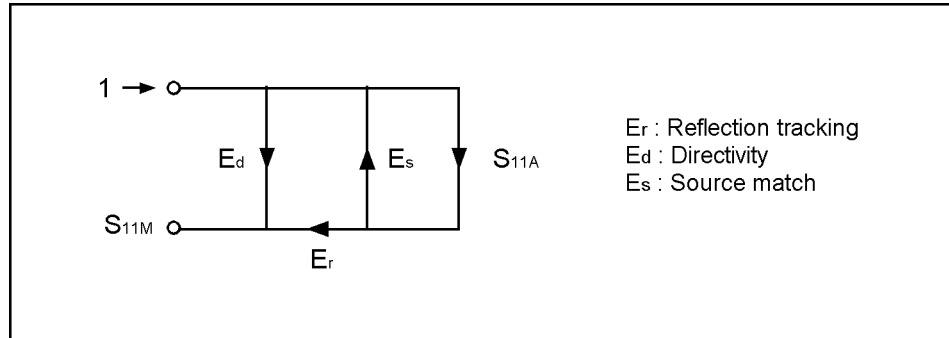

e5070aue152

Figure 4-12 Connecting the standard for 1-port calibration

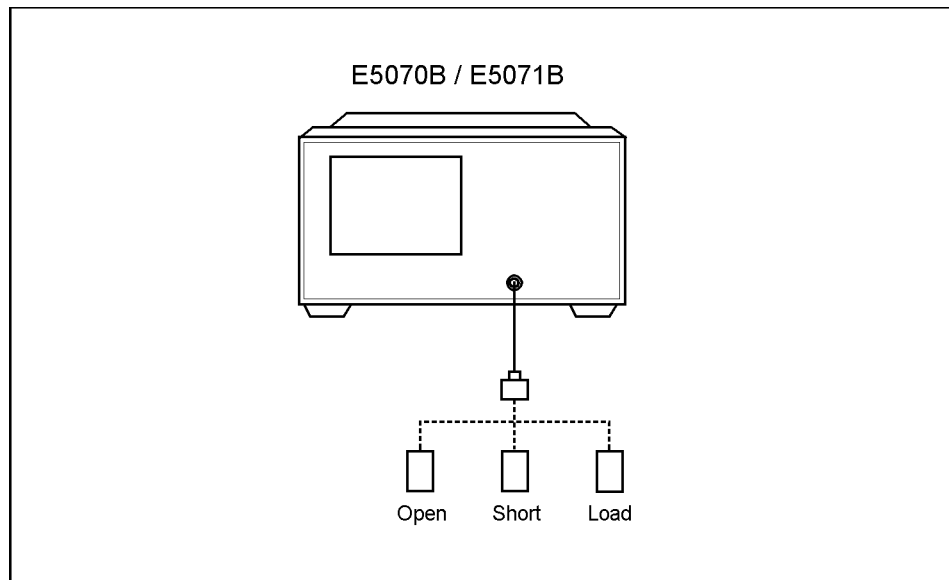

e5070bue012

Calibration
1-Port Calibration (reflection test)

Procedure

- Step 1.** Press **Channel Next** or **Channel Prev** to select the channel for which you want to perform the calibration.
- Step 2.** Press **Cal**.
- Step 3.** Press **Calibrate**.
- Step 4.** Press **1-Port Cal**.
- Step 5.** Press **Select Port**.
- Step 6.** Select a test port (and corresponding S parameter) on which 1-port calibration will be performed.

Softkey	Function
1	Selects port 1
2	Selects port 2
3	Selects port 3
4	Selects port 4

NOTE

An asterisk (*) in the upper-right of the softkey indicates that the existing calibration coefficient will be cleared if you select the test port and execute acquisition of the calibration coefficient (pressing **Done**).

- Step 7.** Connect an OPEN calibration standard to the test port (connector to which the DUT is to be connected) selected in Step 6.
- Step 8.** Press **Open** to start the calibration measurement.
- Step 9.** Connect a SHORT calibration standard to the test port (connector to which the DUT is to be connected) selected in Step 6.
- Step 10.** Press **Short** to start the calibration measurement.
- Step 11.** Connect a LOAD calibration standard to the test port (connector to which the DUT is to be connected) selected in Step 6.
- Step 12.** Press **Load** to start the calibration measurement.
- Step 13.** Press **Done** to terminate the 1-port calibration process. Upon pressing this key, calibration coefficients will be calculated and saved. The error correction function will also be automatically enabled.

Enhanced Response Calibration

In enhanced response calibration, calibration data are measured by connecting an OPEN standard, a SHORT standard, or a LOAD standard to the output port (or a THRU standard between two ports). This calibration effectively eliminates the directivity error, crosstalk, source match error, frequency response reflection tracking error, and frequency response transmission tracking error from the test setup in a transmission or reflection test using those ports (Figure 4-13).

Figure 4-13 2-Port Error Model (Enhanced Response)

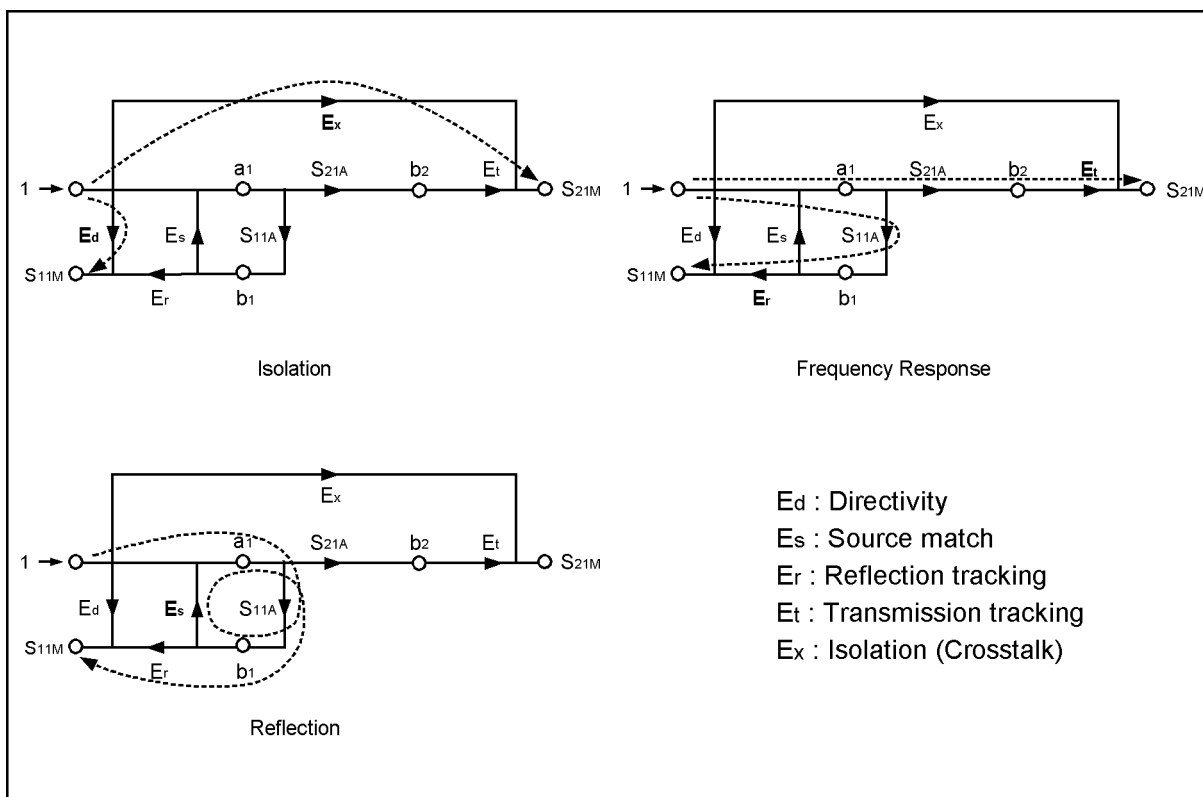

e5061aue010

Figure 4-14 Connecting the Standard at Enhanced Response Calibration

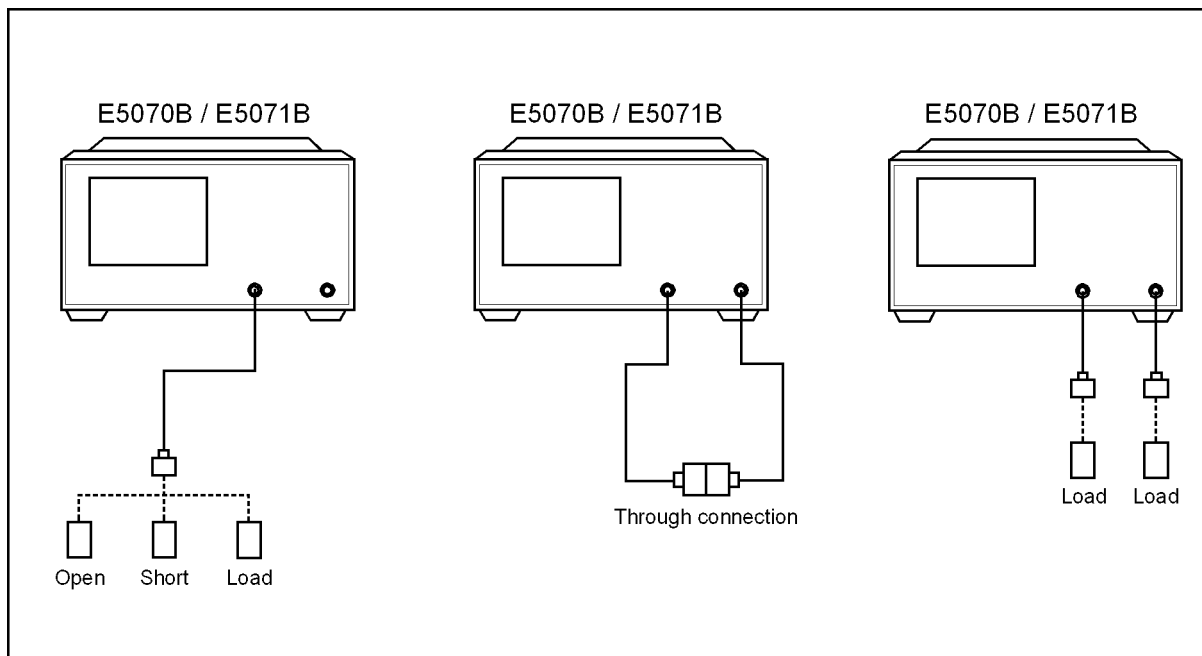

e5070bue7005

Procedure

- Step 1.** Press **Channel Next** or **Channel Prev** to select the channel for which you want to perform the calibration.
- Step 2.** Press **Cal**.
- Step 3.** Press **Calibrate**.
- Step 4.** Press **Enhanced Response**.
- Step 5.** Press **Ports** to select the test ports on which an enhanced response calibration will be performed.

Softkey display	Function
2-1(S21 S11)	Measure between test ports 1 and 2, selecting port 1 as the output.
3-1(S31 S11)	Measure between test ports 1 and 3, selecting port 1 as the output.
4-1(S41 S11)	Measure between test ports 1 and 4, selecting port 1 as the output.
1-2(S12 S22)	Measure between test ports 2 and 1, selecting port 2 as the output.
3-2(S32 S22)	Measure between test ports 2 and 3, selecting port 2 as the output.
4-2(S42 S22)	Measure between test ports 2 and 4, selecting port 2 as the output.
1-3(S13 S33)	Measure between test ports 3 and 1, selecting port 3 as the output.
2-3(S23 S33)	Measure between test ports 3 and 2, selecting port 3 as the output.
4-3(S43 S33)	Measure between test ports 3 and 4, selecting port 3 as the output.

Softkey display	Function
1-4(S14 S44)	Measure between test ports 4 and 1. selecting port 4 as the output.
2-4(S24 S44)	Measure between test ports 4 and 2. selecting port 4 as the output.
3-4(S34 S44)	Measure between test ports 4 and 3. selecting port 4 as the output.

NOTE

An asterisk (*) in the upper right of the softkey indicates that, if you select the test port and execute acquisition of the calibration coefficient (press **Done**), the existing calibration coefficient will be cleared.

- Step 6.** Connect an OPEN calibration standard to the output port.
- Step 7.** Press **Open** to start the calibration measurement.
- Step 8.** Disconnect the OPEN calibration standard that was connected in Step 8 and replace it with a SHORT calibration standard.
- Step 9.** Press **Short** to start the calibration measurement.
- Step 10.** Disconnect the SHORT calibration standard that was connected in Step 8 and replace it with a LOAD standard.
- Step 11.** Press **Load** to start the calibration measurement.
- Step 12.** Make a THRU connection between the two ports.
- Step 13.** Press **Thru** to start the calibration measurement.
- Step 14.** If an isolation calibration must be performed using a LOAD standard, follow the procedure below.
 - a. Connect a LOAD standard to the two test ports.
 - b. Press **Isolation (Optional)** to start the calibration measurement.
- Step 15.** Press **Return**.
- Step 16.** Press **Done** to terminate the enhanced response calibration process. Upon pressing the key, calibration coefficients will be calculated and saved. The error correction function will also be automatically enabled.

Full 2-Port Calibration

In full 2-port calibration, calibration data are measured by connecting an OPEN standard, a SHORT standard, or a LOAD standard to two desired test ports (or a THRU standard between two ports). This calibration effectively eliminates the directivity error, crosstalk, source match error, frequency response reflection tracking error, and frequency response transmission tracking error from the test setup in a transmission or reflection test using those ports (Figure 4-15). This calibration makes it possible to perform measurements with the highest possible accuracy. A total of twelve error terms, six each in the forward direction and the reverse direction, are used in a calibration.

Figure 4-15 Full 2-port error model (forward)

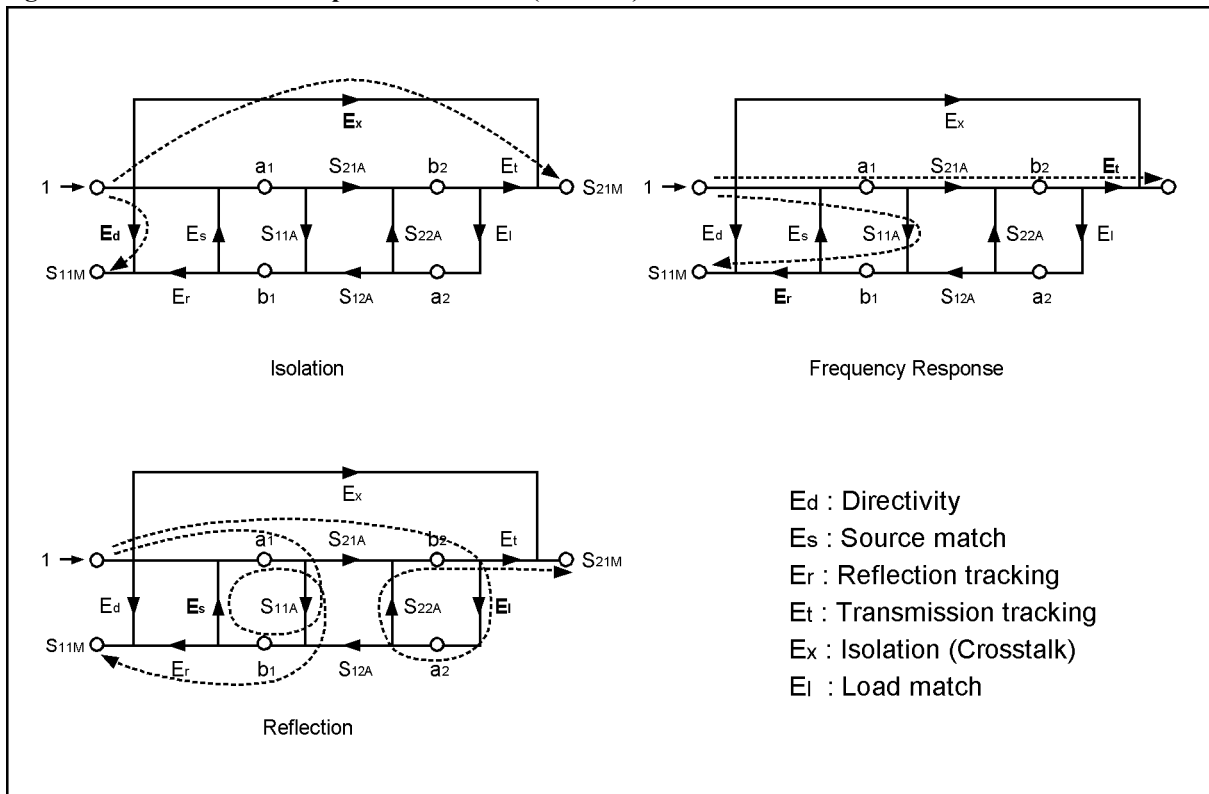

e5070aue144

Figure 4-16 Connecting standards in full 2-port calibration

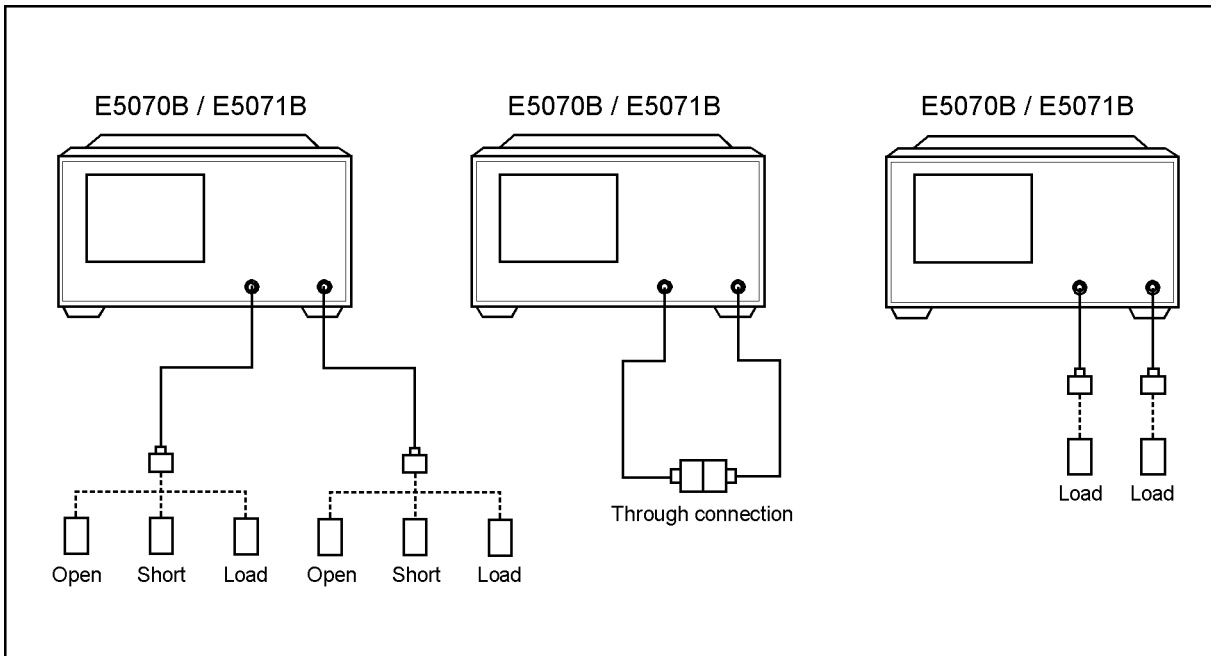

e5070bue013

Procedure

- Step 1.** Press **Channel Next** or **Channel Prev** to select the channel for which you want to perform the calibration.
- Step 2.** Press **Cal**.
- Step 3.** Press **Calibrate**.
- Step 4.** Press **2-Port Cal**.
- Step 5.** Press **Select Ports**.
- Step 6.** Select the test ports on which you will perform full 2-port calibration. (In the procedure below, the selected test ports are denoted as x and y.)

Softkey	Function
1-2	Selects test ports 1 and 2
1-3	Selects test ports 1 and 3
1-4	Selects test ports 1 and 4
2-3	Selects test ports 2 and 3
2-4	Selects test ports 2 and 4
3-4	Selects test ports 3 and 4

NOTE

An asterisk (*) in the upper-right of the softkey indicates that the existing calibration coefficient will be cleared if you select the test port and execute the acquisition of the

Calibration

Full 2-Port Calibration

calibration coefficient (pressing **Done**).

- Step 7.** Press **Reflection**.
- Step 8.** Connect an OPEN calibration standard to test port x (the connector to which the DUT is to be connected) selected in Step 6.
- Step 9.** Press **Port x Open** to start the calibration measurement (**x** denotes the test port to which the standard is connected).
- Step 10.** Disconnect the OPEN calibration standard that was connected in Step 8 and replace it with a SHORT calibration standard.
- Step 11.** Press **Port x Short** to start the calibration measurement (**x** denotes the test port to which the standard is connected).
- Step 12.** Disconnect the SHORT calibration standard that was connected in Step 10 and replace it with a LOAD standard.
- Step 13.** Press **Port x Load** to start the calibration measurement (**x** denotes the test port to which the standard is connected).
- Step 14.** Repeat Step 8 to Step 13 for port y.
- Step 15.** Press **Return**.
- Step 16.** Press **Transmission**.
- Step 17.** Make a THRU connection between ports x and y (between the connectors to which the DUT is to be connected) selected in Step 6.
- Step 18.** Press **Port x-y Thru** to start the calibration measurement (**x** and **y** denote the test ports between which the THRU connection is being made).
- Step 19.** Press **Return**.
- Step 20.** If an isolation calibration must be performed using a LOAD standard, follow the procedure below.
 - a.** Press **Isolation (Optional)**.
 - b.** Connect a LOAD standard to each of the two test ports (connectors to which the DUT is to be connected) selected in Step 6.
 - c.** Press **Port x-y Isol** to start the calibration measurement (**x** and **y** denote the port numbers to which the LOAD standard is connected).
- Step 21.** Press **Return**.
- Step 22.** Press **Done** to terminate the full 2-port calibration process. Upon pressing this key, calibration coefficients will be calculated and saved. The error correction function will also be automatically enabled.

Full 3-Port Calibration

In full 3-port calibration, calibration data are measured by connecting an OPEN standard, a SHORT standard, or a LOAD standard to three desired test ports (or a THRU standard between three ports). This calibration effectively eliminates the directivity error, crosstalk, source match error, load match error, frequency response reflection tracking error, and frequency response transmission tracking error from the test setup in a transmission or reflection test using those ports (Figure 4-17). As in full 2-port calibration, this calibration method also makes it possible to perform measurements with the highest possible accuracy. There are unique error terms for directivity, source match, and reflection tracking for each stimulus test port (3×3 ports = 9). As for isolation, load match, and transmission tracking errors, there are unique terms for each combination between a stimulus port and a response port (3×6 combinations = 18). Therefore, in total, 27 error terms are involved in a full 3-port calibration.

Figure 4-17 Full 3-port error model (Options 313, 314, 413, and 414)

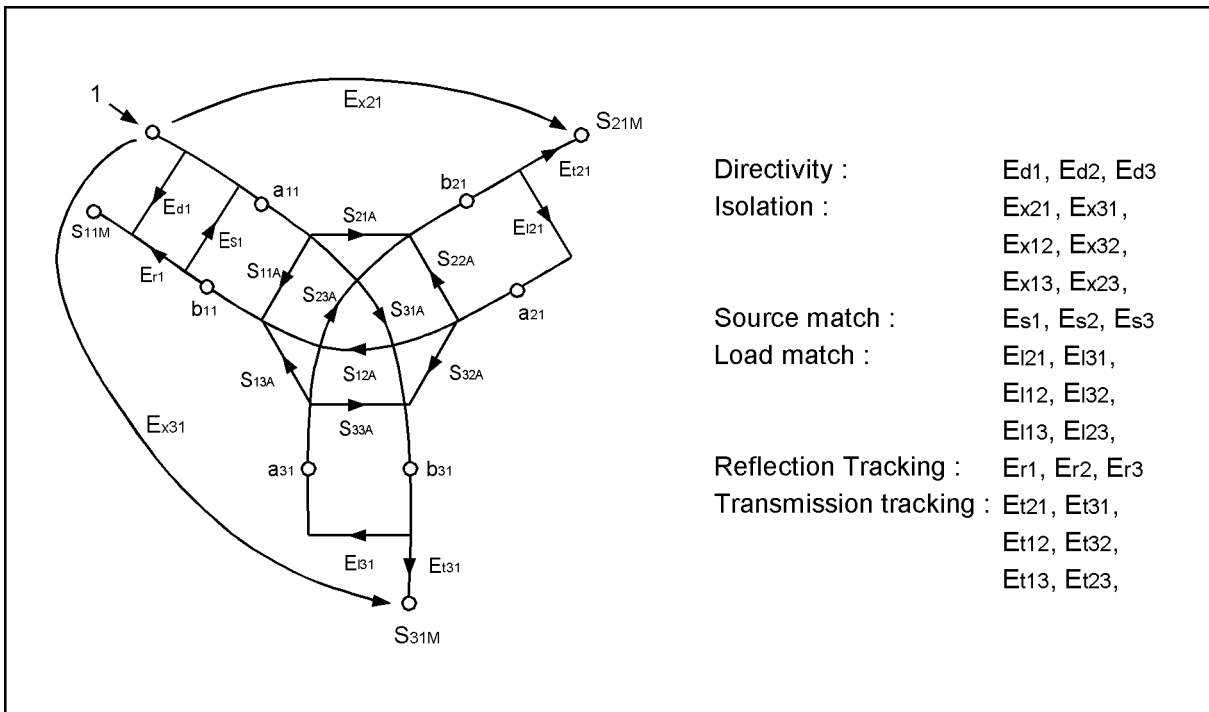

e5070aue145

Figure 4-18 Connecting standards in full 3-port calibration

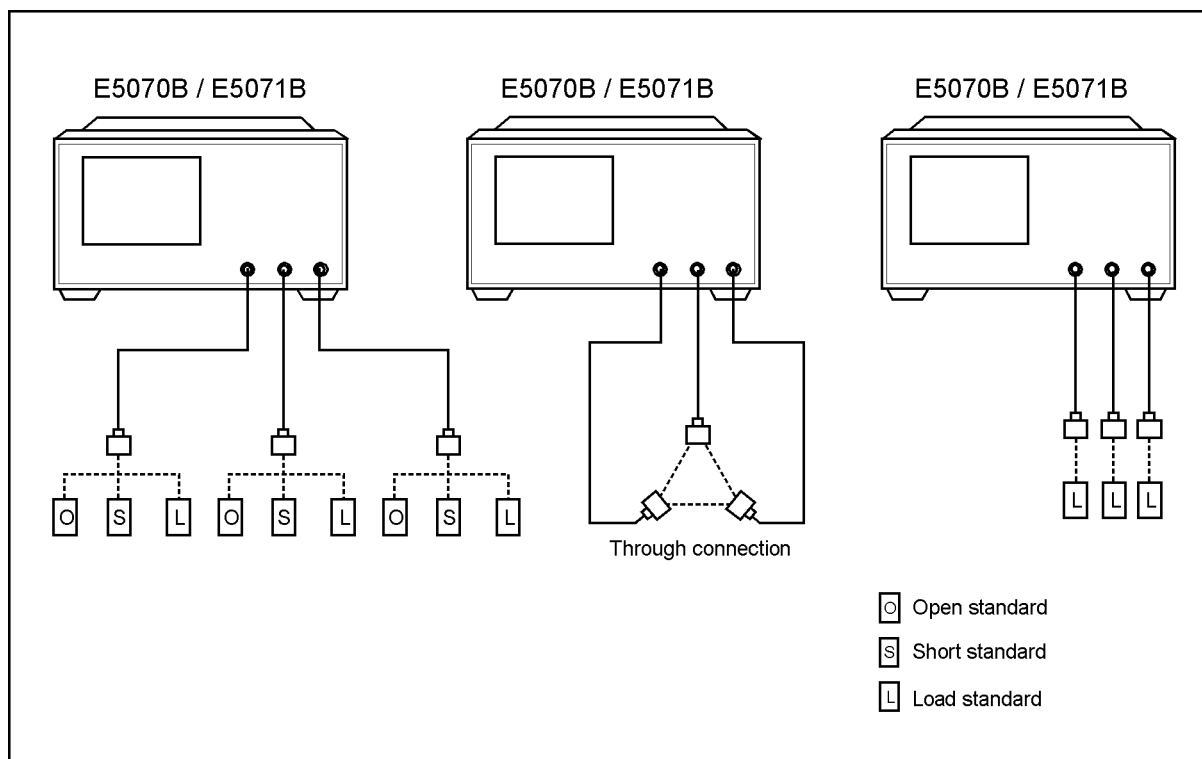

e5070bue014

Procedure

- Step 1.** Press **Channel Next** or **Channel Prev** to select the channel for which you want to perform the calibration.
- Step 2.** Press **Cal**.
- Step 3.** Press **Calibrate**.
- Step 4.** Press **3-Port Cal**.
- Step 5.** Press **Select Ports**.
- Step 6.** Select the test ports on which you will perform full 3-port calibration. (In the procedure below, the selected test ports are denoted as x, y, and z.)

Softkey	Function
1-2-3	Selects test ports 1, 2, and 3
1-2-4	Selects test ports 1, 2, and 4
1-3-4	Selects test ports 1, 3, and 4
2-3-4	Selects test ports 2, 3, and 4

NOTE

An asterisk (*) in the upper-right of the softkey indicates that the existing calibration coefficient will be cleared if you select the test port and execute acquisition of the

calibration coefficient (pressing **Done**).

- Step 7.** Press **Reflection**.
- Step 8.** Connect an OPEN calibration standard to test port x (the connector to which the DUT is to be connected) selected in Step 6.
- Step 9.** Press **Port x Open** to start the calibration measurement (**x** denotes the test port to which the standard is connected).
- Step 10.** Disconnect the OPEN calibration standard that was connected in Step 8 and replace it with a SHORT calibration standard.
- Step 11.** Press **Port x Short** to start the calibration measurement (**x** denotes the test port to which the standard is connected).
- Step 12.** Disconnect the SHORT calibration standard that was connected in Step 10 and replace it with a LOAD standard.
- Step 13.** Press **Port x Load** to start the calibration measurement (**x** denotes the test port to which the standard is connected).
- Step 14.** Repeat Step 8 to Step 13 on port y.
- Step 15.** Repeat Step 8 to Step 13 on port z.
- Step 16.** Press **Return**.
- Step 17.** Press **Transmission**.
- Step 18.** Make a THRU connection between ports x and y (between the connectors to which the DUT will be connected) selected in Step 6.
- Step 19.** Press **Port x-y Thru** to start the calibration measurement (**x** and **y** denote the test ports between which a THRU connection is being made).
- Step 20.** Repeat Step 18 and Step 19 on ports x and z.
- Step 21.** Repeat Step 18 and Step 19 on ports y and z.
- Step 22.** Press **Return**.
- Step 23.** If an isolation calibration must be performed using a LOAD standard, follow the procedure below.
 - a.** Press **Isolation (Optional)**.
 - b.** Connect a LOAD standard to each of the three test ports x, y, and z (the connectors to which the DUT is to be connected) selected in Step 6.
 - c.** Press **Port x-y Isol** to start the calibration measurement.
 - d.** Press **Port x-z Isol** to start the calibration measurement.
 - e.** Press **Port y-z Isol** to start the calibration measurement.
- Step 24.** Press **Return**.
- Step 25.** Press **Done** to terminate the full 3-port calibration process. Upon pressing this key, calibration coefficients will be calculated and saved. The error correction function will also be automatically enabled.

Full 4-Port Calibration

In full 4-port calibration, calibration data are measured by connecting an OPEN standard, a SHORT standard, or a LOAD standard to the four test ports (or a THRU standard between the four ports). This calibration effectively eliminates the directivity error, crosstalk, source match error, load match error, frequency response reflection tracking error, and frequency response transmission tracking error from the test setup in a transmission or reflection test using those ports (Figure 4-19). As in full 2-port calibration, this calibration method also makes it possible to perform measurements with the highest possible accuracy. There are unique error terms for directivity, source match, and reflection tracking for each stimulus test port (3×4 ports = 12). As for isolation, load match, and transmission tracking errors, there are unique terms for each combination between a stimulus port and a response port (3×12 combinations = 36). Therefore, in total, 48 error terms are involved in a full 4-port calibration.

Figure 4-19 Full 4-port error model (Options 413 and 414)

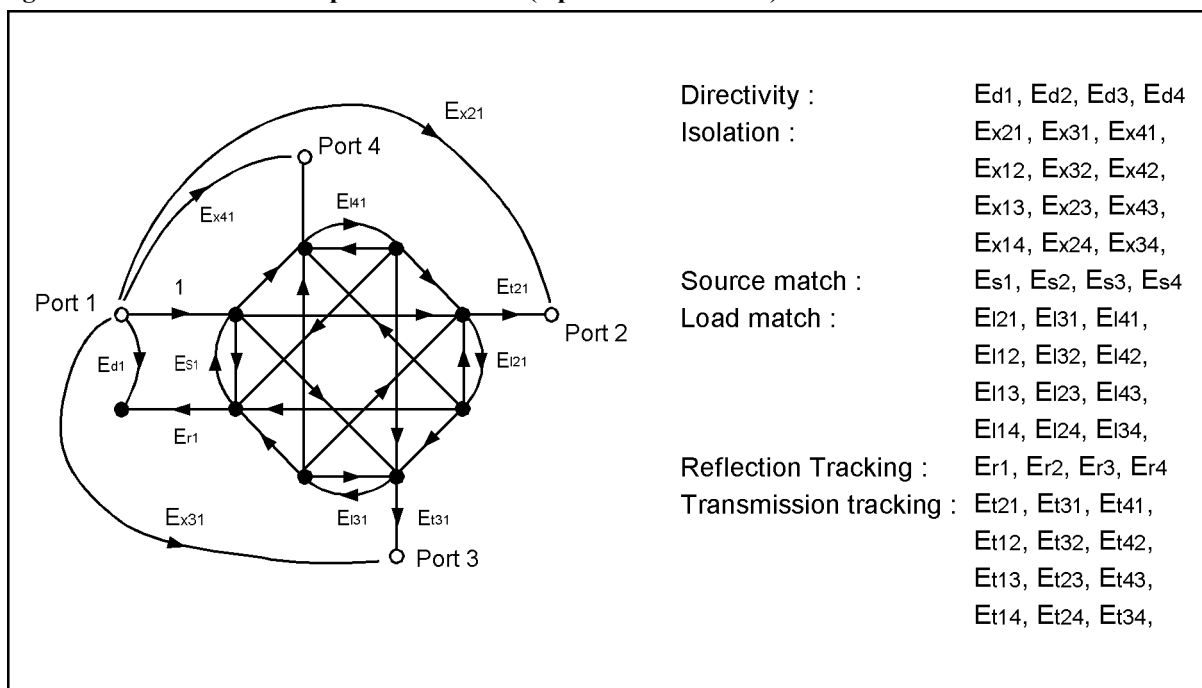

e5070aue146

Figure 4-20 Connecting standards in full 4-port calibration

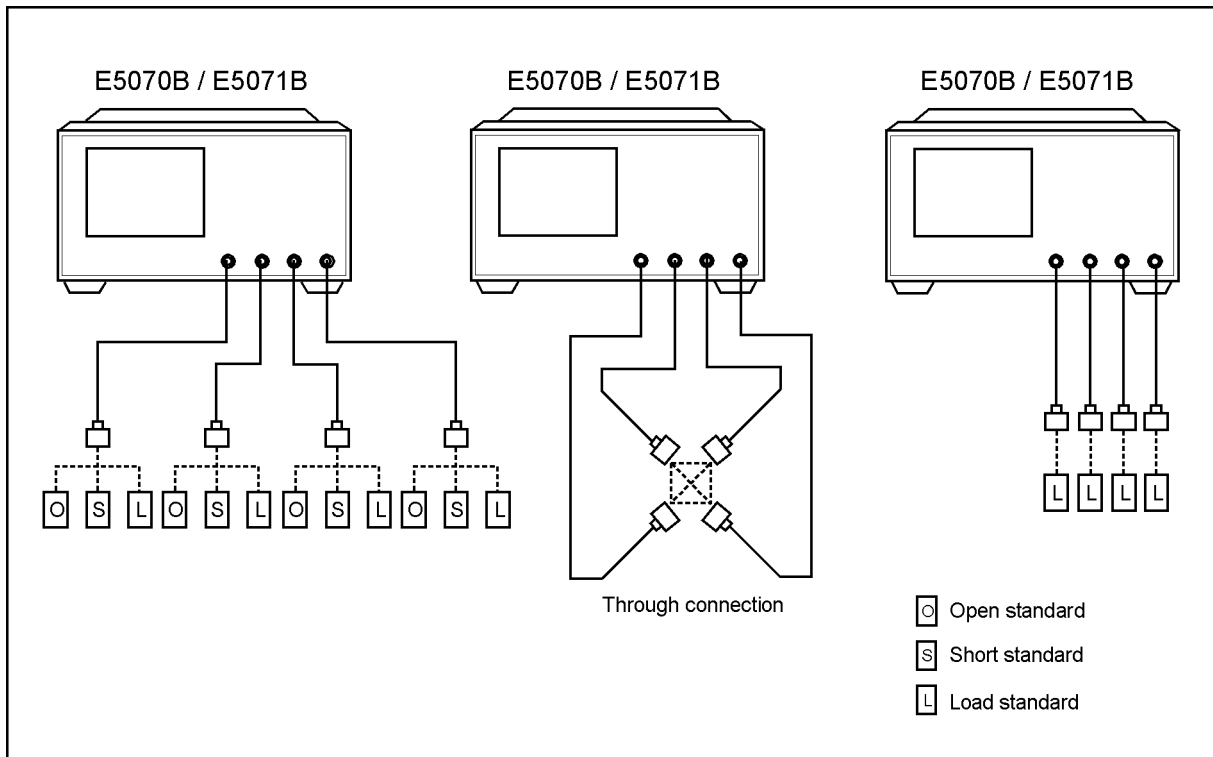

e5070bue015

Procedure

- Step 1.** Press **Channel Next** or **Channel Prev** to select the channel for which you want to perform the calibration.
- Step 2.** Press **Cal**.
- Step 3.** Press **Calibrate**.
- Step 4.** Press **4-Port Cal**.
- Step 5.** Press **Reflection**.
- Step 6.** Connect an OPEN calibration standard to test port 1 (the connector to which the DUT is to be connected).
- Step 7.** Press **Port 1 Open** to start the calibration measurement.
- Step 8.** Disconnect the OPEN calibration standard connected in Step 6 and replace it with a SHORT calibration standard.
- Step 9.** Press **Port 1 Short** to start the calibration measurement.
- Step 10.** Disconnect the SHORT calibration standard connected in Step 8 and replace it with a LOAD calibration standard.
- Step 11.** Press **Port 1 Load** to start the calibration measurement.
- Step 12.** Repeat Step 6 to Step 11 on test port 2.

Calibration

Full 4-Port Calibration

- Step 13.** Repeat Step 6 to Step 11 on test port 3.
- Step 14.** Repeat Step 6 to Step 11 on test port 4.
- Step 15.** Press **Return**.
- Step 16.** Press **Transmission**.
- Step 17.** Make a THRU connection between ports 1 and 2 (between the connectors to which the DUT will be connected).
- Step 18.** Press **Port 1-2 Thru** to start the calibration measurement.
- Step 19.** Repeat Step 17 and Step 18 on ports 1 and 3.
- Step 20.** Repeat Step 17 and Step 18 on ports 1 and 4.
- Step 21.** Repeat Step 17 and Step 18 on ports 2 and 3.
- Step 22.** Repeat Step 17 and Step 18 on ports 2 and 4.
- Step 23.** Repeat Step 17 and Step 18 on ports 3 and 4.
- Step 24.** Press **Return**.
- Step 25.** If an isolation calibration must be performed using a LOAD standard, follow the procedure below.
- a. Press **Isolation (Optional)**.
 - b. Connect a LOAD standard to each of the four test ports (connectors to which the DUT is to be connected).
 - c. Press **Port 1-2 Isol** to start the calibration measurement.
 - d. Press **Port 1-3 Isol** to start the calibration measurement.
 - e. Press **Port 1-4 Isol** to start the calibration measurement.
 - f. Press **Port 2-3 Isol** to start the calibration measurement.
 - g. Press **Port 2-4 Isol** to start the calibration measurement.
 - h. Press **Port 3-4 Isol** to start the calibration measurement.
- Step 26.** Press **Return**.
- Step 27.** Press **Done** to terminate the full 4-port calibration process. Upon pressing this key, calibration coefficients will be calculated and saved. The error correction function will also be automatically enabled. By pressing **Done**, previously saved calibration coefficients will be overwritten with new ones.

ECal (electronic calibration)

ECal is a calibration method that uses solid-state circuit technology. ECal offers the following advantages:

- Simplified calibration process.
- Shorter time required for calibration.
- Reduced chance of erroneous operation.
- Little degradation of performance due to wear because the ECal module employs PIN diodes and FET switches.

1-Port Calibration Using a 2-Port ECal Module

Follow the procedure below to perform a 1-port calibration using the 2-port ECal module.

- Step 1.** Connect the USB port on the ECal module with the USB port on the E5070B/E5071B via a USB cable. This connection may be made while the E5070B/E5071B's power is on.
- Step 2.** Connect a port on the ECal module to the test port to be calibrated.

NOTE

You can connect the ports of the ECal and the test ports of the E5070B/E5071B arbitrarily. Connected ports can be manually specified although they are automatically detected before data measurement. For more information, “Turning off ECal auto-detect function” on page 131.

NOTE

If you don't use all of the ECal module's ports, connect terminations to the unused ports.

Figure 4-21

Connecting ECal module (1-port calibration)

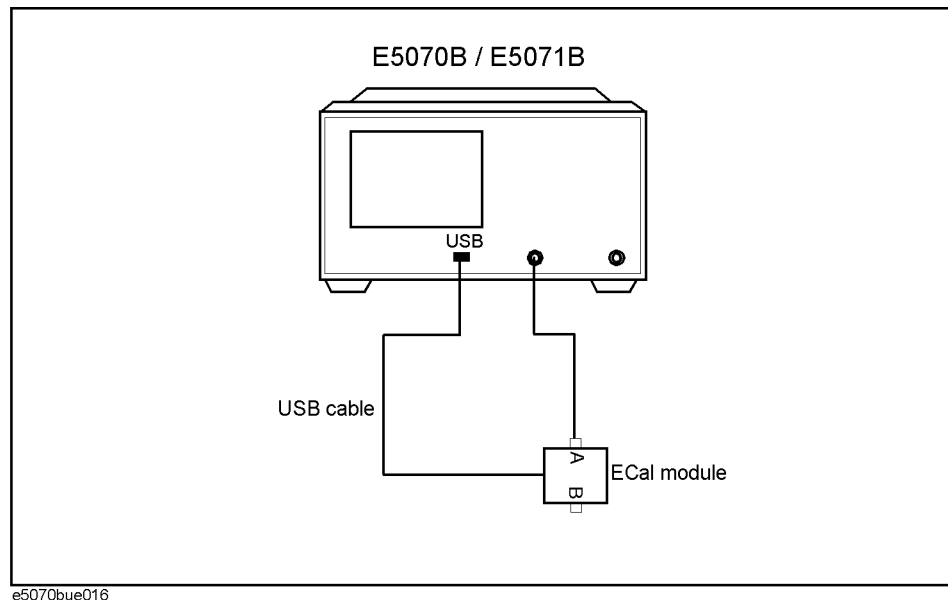

Calibration

ECal (electronic calibration)

- Step 3.** Press **Channel Next** or **Channel Prev** to select the channel for which you want to perform the calibration.
- Step 4.** Press **Cal**.
- Step 5.** Press **ECal**.
- Step 6.** Press **1 Port ECal**.
- Step 7.** Perform a 1-port calibration.

Softkey	Function
Port 1	Performs a 1-port calibration on test port 1
Port 2	Performs a 1-port calibration on test port 2
Port 3 ^{*1}	Performs a 1-port calibration on test port 3
Port 4 ^{*2}	Performs a 1-port calibration on test port 4

*1. Only with Options 313, 314, 413, and 414.

*2. Only with Options 413 and 414.

Full 2-Port Calibration Using the 2-Port ECal Module

Follow the procedure below to perform a full 2-port calibration using the 2-port ECal module.

- Step 1.** Connect the USB port on the ECal module with the USB port on the E5070B/E5071B via a USB cable. This connection may be done while the E5070B/E5071B's power is on.
- Step 2.** Connect port A and port B on the ECal module to the test ports to be calibrated.

NOTE

You can connect the ports of the ECal and the test ports of the E5070B/E5071B arbitrarily. Connected ports can be manually specified although they are automatically detected before data measurement. For more information, "Turning off ECal auto-detect function" on page 131.

Figure 4-22 **Connecting ECal module (full 2-port calibration)**

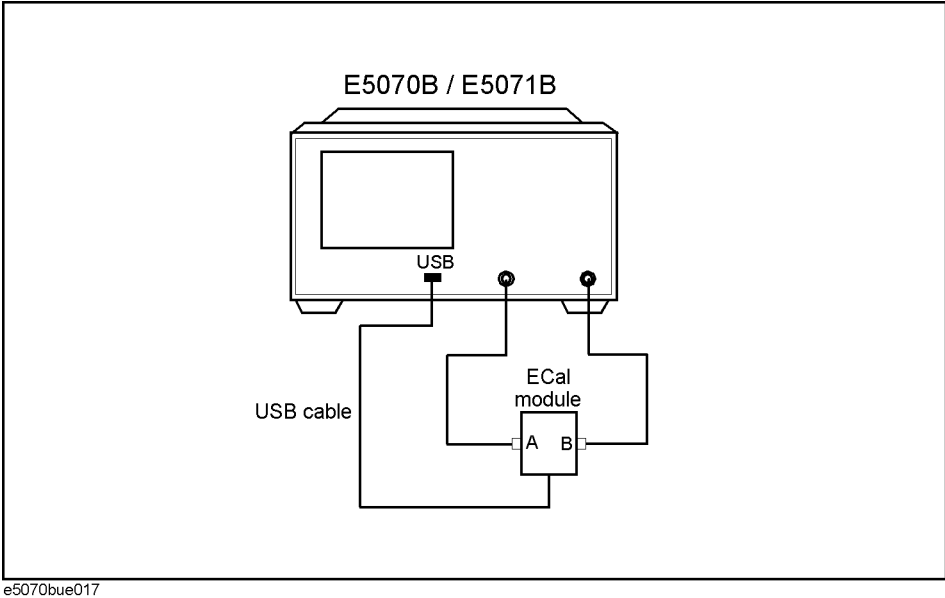

- Step 3.** Press **Channel Next** or **Channel Prev** to select the channel for which you want to perform the calibration.
- Step 4.** Press **Cal**.
- Step 5.** Press **ECal**.
- Step 6.** To enable isolation calibration, press **Isolation** and confirm that the display has turned **ON**.
- Step 7.** Press **2 Port ECal**. When using a 2-port E5070B/E5071B (Options 213 or 214), pressing this key performs a 2-port ECal.
- Step 8.** When using a 3-port or 4-port E5070B/E5071B (Options 313, 314, 413, or 414), press one of the softkeys below to start a full 2-port calibration.

Softkey	Function
Port 1-2	Performs a full 2-port calibration between test ports 1 and 2
Port 1-3	Performs a full 2-port calibration between test ports 1 and 3
Port 1-4^{*1}	Performs a full 2-port calibration between test ports 1 and 4
Port 2-3	Performs a full 2-port calibration between test ports 2 and 3
Port 2-4^{*1}	Performs a full 2-port calibration between test ports 2 and 4
Port 3-4^{*1}	Performs a full 2-port calibration between test ports 3 and 4

^{*1}. Only with Options 413 and 414.

Calibration
ECal (electronic calibration)

Unknown Thru Calibration

E5070B/E5071B allows you to perform thru calibration of ECal as unknown thru calibration. In this function, the thru calibration is done with thru standard in ECal, however, the stored thru calibration data in ECal is not used. E5070B/E5071B performs thru calibration as a unknown thru calibration.

For more detail on the unknown thru calibration, see “Unknown Thru Calibration” on page 153.

- Step 1.** Press .
- Step 2.** Press **ECal**.
- Step 3.** Press **Unknown Thru** to turn on.
- Step 4.** Perform your desired ECal calibration.

Turning off ECal auto-detect function

The ECal module automatically detects the connection between E5070B/E5071B's test ports and ECal module's ports. You can turn off this function to set ports manually.

NOTE

Even if the connection is wrong with the auto-detect function turned off, no error is displayed.

Step 1. Press **Channel Next** or **Channel Prev** to select the channel for which you want to turn off the auto-detect function.

Step 2. Press **Cal**.

Step 3. Press **ECal**.

Step 4. Press **Orientation**, and select **Manual**.

Softkey	Function
Auto	Turns on the auto-detect function.
Manual	Turns off the auto-detect function.

Step 5. Specify a test port of the E5070B/E5071B.

Softkey	Function
Port 1	Specifies port 1 of the E5070B/E5071B.
Port 2	Specifies port 2 of the E5070B/E5071B.
Port 3 ^{*1}	Specifies port 3 of the E5070B/E5071B.
Port 4 ^{*2}	Specifies port 4 of the E5070B/E5071B.

*1. Only with Options 313, 314, 413, and 414.

*2. Only with Options 413 and 414.

Step 6. Specify an Ecal port for the port of the E5070B/E5071B you specified.

Softkey	Function
Port A	Specifies port A of Ecal.
Port B	Specifies port B of Ecal.
Port C ^{*1}	Specifies port C of Ecal.
Port D ^{*2}	Specifies port D of Ecal.

*1. Only with Ecal modules supporting 3 ports and 4 ports.

*2. Only with Ecal modules supporting 4 ports.

Full 3-Port and Full 4-Port Calibration using 2-Port ECal

A VBA macro (ECal Assistant) is pre-installed in the E5070B/E5071B to carry out a full 3-port or a full 4-port calibration using the 2-port ECal.

NOTE

ECal Assistant does not perform isolation calibration.

Operational procedure

- Step 1.** Connect the USB port of the ECal module to the USB port on the E5070B/E5071B with a USB cable. The connection may be made while the E5070B/E5071B's power is on.
- Step 2.** Press **Macro Setup**.
- Step 3.** Press **Load Project**.
- Step 4.** From the Open dialog box, select the VBA project file "D:\Agilent\ECalAssistant.VBA" and press the **Open** button.
- Step 5.** Press **Macro Run**.

The dialog box shown in Figure 4-23 appears.

Figure 4-23

ECalAssistant (start) dialog box

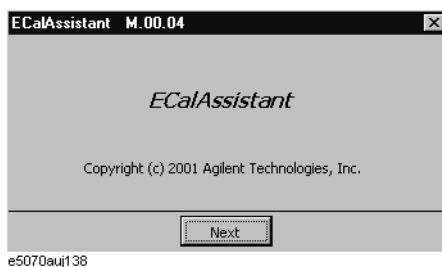

- Step 6.** Press the **Next** button.

The dialog box shown in Figure 4-24 appears.

Figure 4-24

ECalAssistant (Port/Channel Selection) dialog box

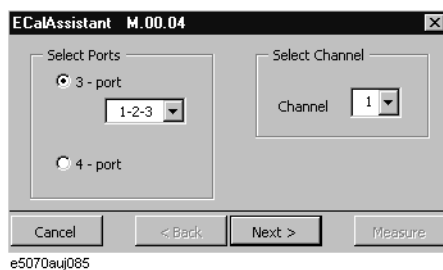

- Step 7.** In the Select Ports area, click and select the **3-Port** (for a full 3-port calibration) or the **4-Port** (for a full 4-port calibration) radio button.

- Step 8.** When a full 3-port calibration is carried out on an E5070B/E5071B with options 413 or 414, select the test ports to be calibrated from the drop-down list box below the **3-Port** button (either **1-2-3**, **1-2-4**, **1-3-4**, or **2-3-4**).
- Step 9.** In the Select Channel area, select the channel to be calibrated (one of channels **1 ~ 9**).
- Step 10.** Press the **Next** button.

The dialog box shown in Figure 4-25 appears.

Figure 4-25

ECalAssistant (Connection) dialog box

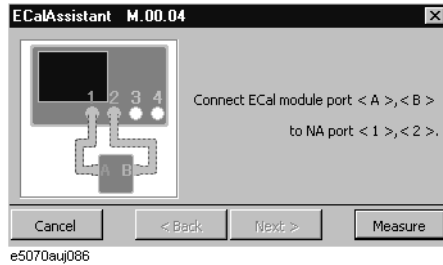

- Step 11.** Following the connection diagram shown in the dialog box (Figure 4-25), connect ports A and B of the ECal module to test ports on the E5070B/E5071B.

Note that the connection diagram shown in each dialog box that appears in each step depends on the number of test ports on the E5070B/E5071B (options 313/314 or 413/414) as well as the test port selection made in Step 8.

- Step 12.** Press the **Measure** button to start the measurement of calibration data.

Upon completion of measurement, the dialog box shown in Figure 4-26 will be displayed.

Figure 4-26

ECalAssistant (Measurement Complete) dialog box

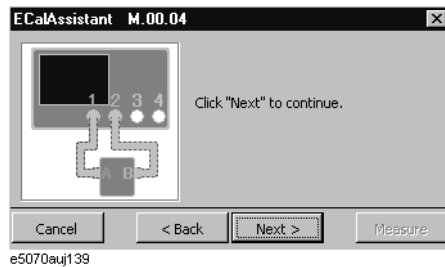

- Step 13.** Press the **Next** button.

The dialog box shown in Figure 4-27 appears.

Figure 4-27

EcalAssistant (Connection) dialog box

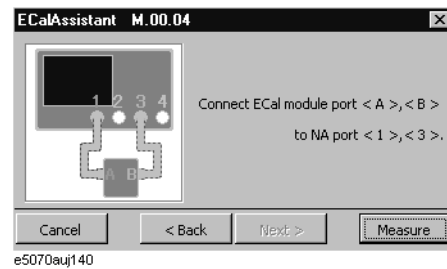

Step 14. Re-connect the ECal module following the instructions given in each dialog box and continue the calibration process.

Step 15. When all calibration data have been collected, a dialog box with the *Complete!* sign appears as shown in Figure 4-28. Press the **Done** button to finish the calibration. If you wish to cancel the calibration, press the **Cancel** button.

Figure 4-28

EcalAssistant (Finish) dialog box

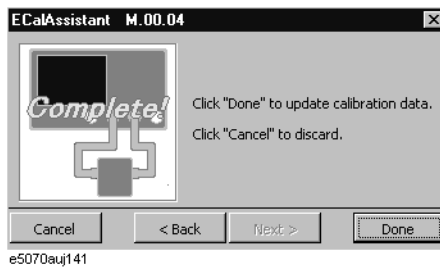

Calibration Using 4-port ECal

The E5070B/E5071B allows you to perform calibration using the 4-port ECal module. It provides much simpler operation than when using the 2-port ECal. Especially when using a multi-port test set, calibration time and operator errors can be reduced significantly.

Operational procedure

To execute full 2-port calibration using the 4-port ECal module, follow these steps.

- Step 1.** Connect the USB cable between the USB port of the 4-port ECal module and the USB port of the E5070B/E5071B. You can make this connection while the E5070B/E5071B's power is on.
- Step 2.** Connect the ports of the 4-port ECal module to the test ports you want to calibrate.

Figure 4-29

Connecting 4-port ECal module (for full 4-port calibration)

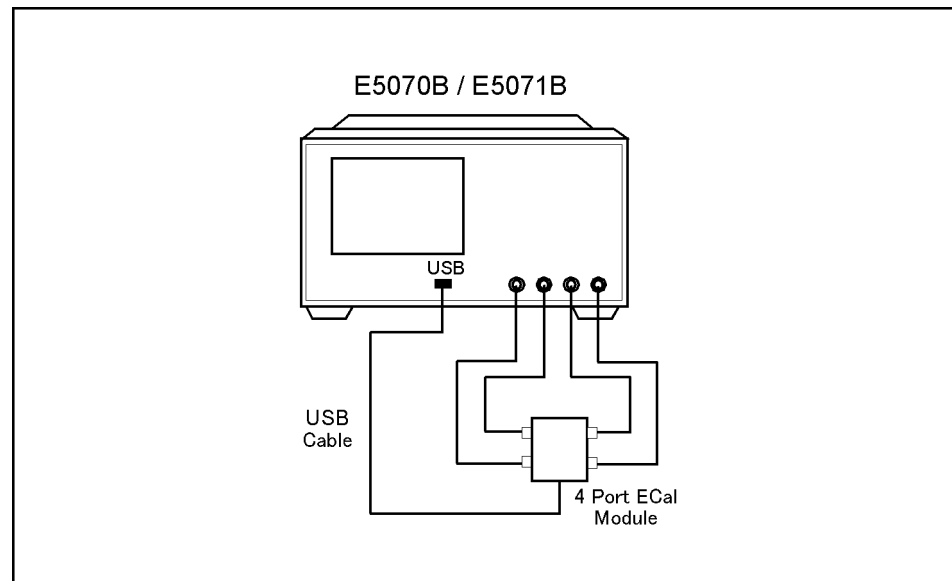

e5070bue018

NOTE

You can connect the ports of the ECal and the test ports of the E5070B/E5071B arbitrarily. Connected ports can be manually specified although they are automatically detected before data measurement. For more information, “Turning off ECal auto-detect function” on page 131.

NOTE

If you don't use all of the ECal module's ports, connect terminations to the unused ports.

- Step 3.** Press **Channel Next** or **Channel Prev** to select the channel for which you want to perform the calibration.
- Step 4.** Press **Cal**.
- Step 5.** Press **ECal**.

Calibration
Calibration Using 4-port ECal

Step 6. When you want to turn ON the isolation calibration, press **Isolation** (set to **ON**).

Step 7. Select the calibration type based on the list below.

Softkey	Function
1-Port ECal	Selects 1-port calibration
2-Port ECal	Selects full 2-port calibration
3-Port ECal ^{*1}	Selects full 3-port calibration
4-Port ECal ^{*2}	Selects full 4-port calibration
Thru ECal	Selects THRU calibration

*1. Options 313, 314, 413, and 414 only

*2. Options 413 and 414 only

Step 8. If you must select a port, the softkey for making this selection is displayed. Select a port and start calibration. If you do not have to select a port, this step is skipped.

Step 9. The E5070B/E5071B detects the test ports connected to the ECal and then measurement starts.

NOTE

If a test port to be calibrated is not connected to the ECal module, an error occurs.

2-port TRL calibration

The 2-port TRL calibration function lets you measure calibration data by connecting thru, reflection (open or short), line, or match calibration standards to (between) 2 desired test ports. This calibration provides the most accurate measurement for non-coaxial parts, using 12 error terms in total for calibration in the same way as full 2-port calibration.

NOTE

This function is available with firmware version A.06.00 or greater. For firmware version A.06.00 or earlier, you can use VBA macros to define/save calibration kits and execute calibration. For more information, see Appendix A, “Manual Changes,” on page 583.

Before executing TRL calibration, you need to modify the calibration kit definition you use (or create a new one). For more information, see “Changing the Calibration Kit Definition” on page 181.

Figure 4-30 2-port TRL error model (forward direction)

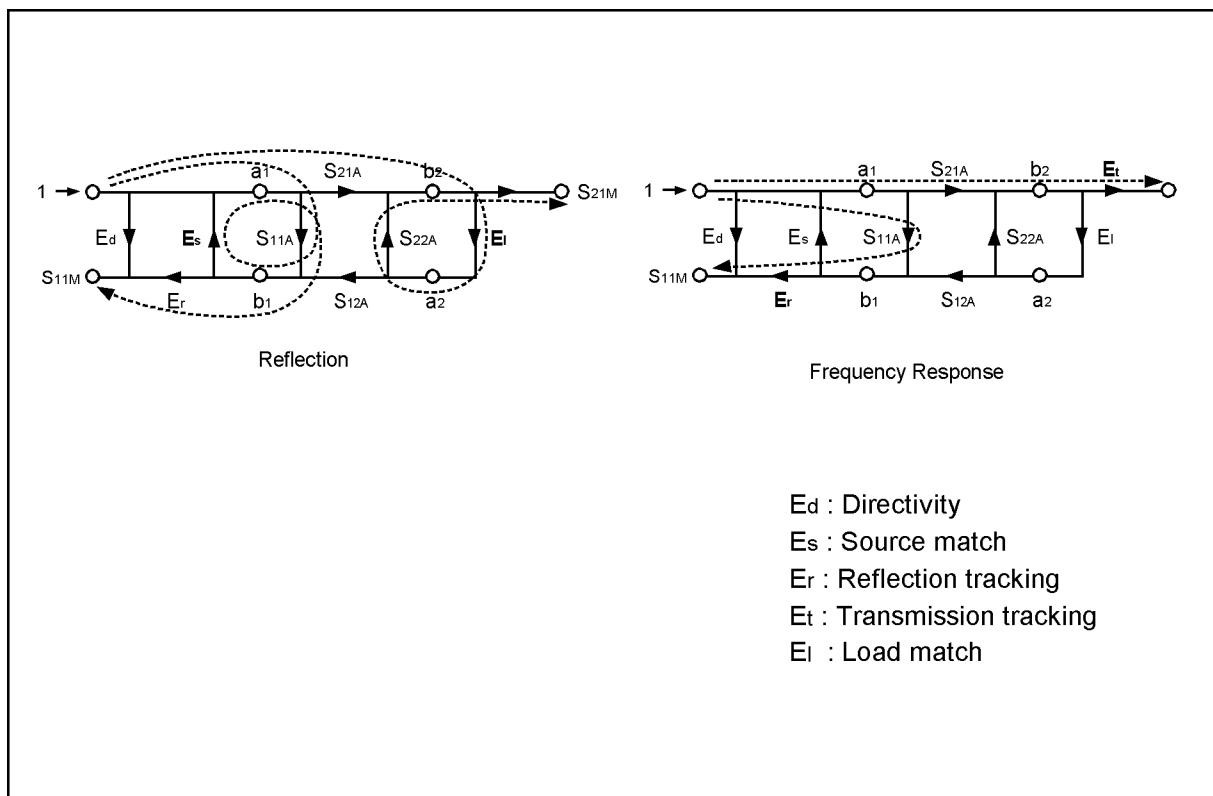

e5070bue8006

Operational procedure

Figure 4-31 Connection of standards in 2-port TRL calibration

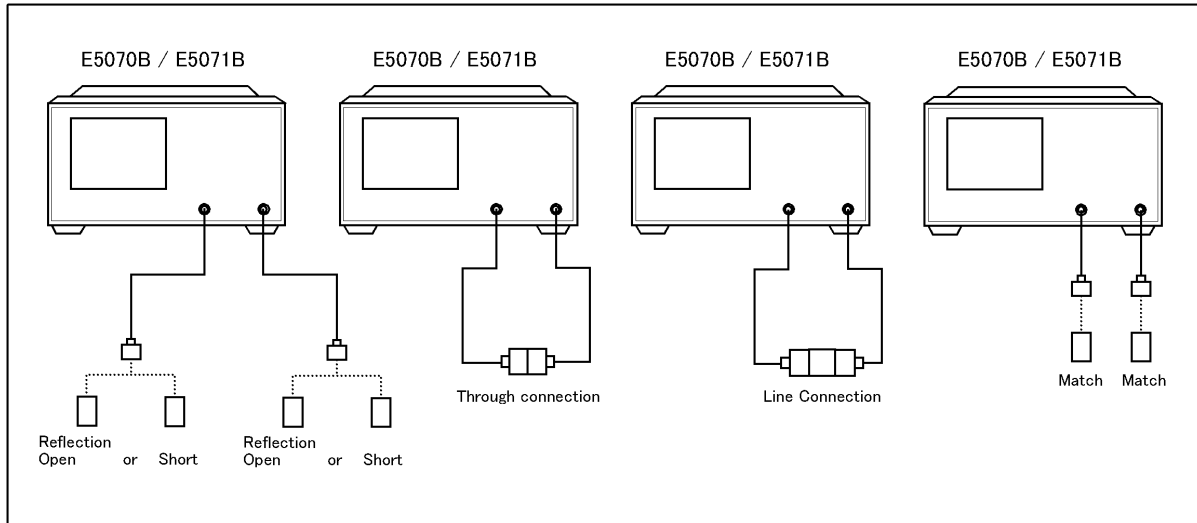

NOTE

The shapes of actual standards differ from those shown in Figure 4-31 which are just symbols for illustration.

- Step 1.** Press **Channel Next** or **Channel Prev** to select the channel for which you want to execute calibration.
- Step 2.** Press **Cal**.
- Step 3.** Press **Calibrate**.
- Step 4.** Press **2-Port TRL Cal**.
- Step 5.** Press **Select Ports**.
- Step 6.** Select the test ports for which you want to execute TRL 2-port calibration. (In the following procedure, test ports you select here are expressed as test ports x and y.)

Softkey	Function
1-2	Selects test ports 1 and 2.
1-3	Selects test ports 1 and 3.
1-4	Selects test ports 1 and 4.
2-3	Selects test ports 2 and 3.
2-4	Selects test ports 2 and 4.
3-4	Selects test ports 3 and 4.

NOTE

An asterisk (*) in the upper right of the softkey indicates that a calibration coefficient exists

that will be cleared if you select the test port and execute acquisition of the calibration coefficient (by pressing **Done**).

Step 7. Thru/Line to start the measurement of the calibration standard.

Softkey	Function
Port x-y Thru	Executes thru/line calibration for test ports x and y.

Step 8. Reflect to start the measurement of the calibration standard.

Softkey	Function
Port x Reflect	Executes reflection calibration for test port x.
Port y Reflect	Executes reflection calibration for test port y.

Step 9. Line/Match to start the measurement of the calibration standard.

Softkey	Function
x-y Line/Match *1	Executes line/match calibration for test ports x and y. Use this to perform forward-direction measurement and reverse-direction measurement at the same time.
x-y Fwd (Syx) *2	Executes line/match calibration for test ports x and y. Use this to perform forward-direction measurement only.
x-y Rvs (Sxy) *2	Executes line/match calibration for test ports x and y. Use this to perform reverse-direction measurement only.

*1. This is equivalent to measuring **x-y Fwd (Syx)** and **x-y Rvs (Sxy)**.

*2. Measuring **x-y Fwd (Syx)** and **x-y Rvs (Sxy)** is equivalent to measuring **x-y Line/Match**.

Step 10. Press **Done** to finish TRL 2-port calibration. At this point, the calibration coefficient is calculated and saved. The error correction function is automatically turned on.

3-port TRL calibration

The 3-port TRL calibration function lets you measure calibration data by connecting thru, reflection (open or short), line, or match calibration standards to (between) 3 desired test ports. This calibration provides the most accurate measurement for non-coaxial parts, using 27 error terms in total for calibration in the same way as full 3-port calibration.

NOTE

This function is available with firmware version A.06.00 or later. For firmware version A.06.00 or earlier, you can use VBA macros to define/save calibration kits and execute calibration. For more information, see Appendix A, “Manual Changes,” on page 583.

Before executing TRL calibration, you need to modify the calibration kit definition you use (or create a new one). For more information, see “Changing the Calibration Kit Definition” on page 181.

Figure 4-32 3-port TRL error model (options 313, 314, 413, 414)

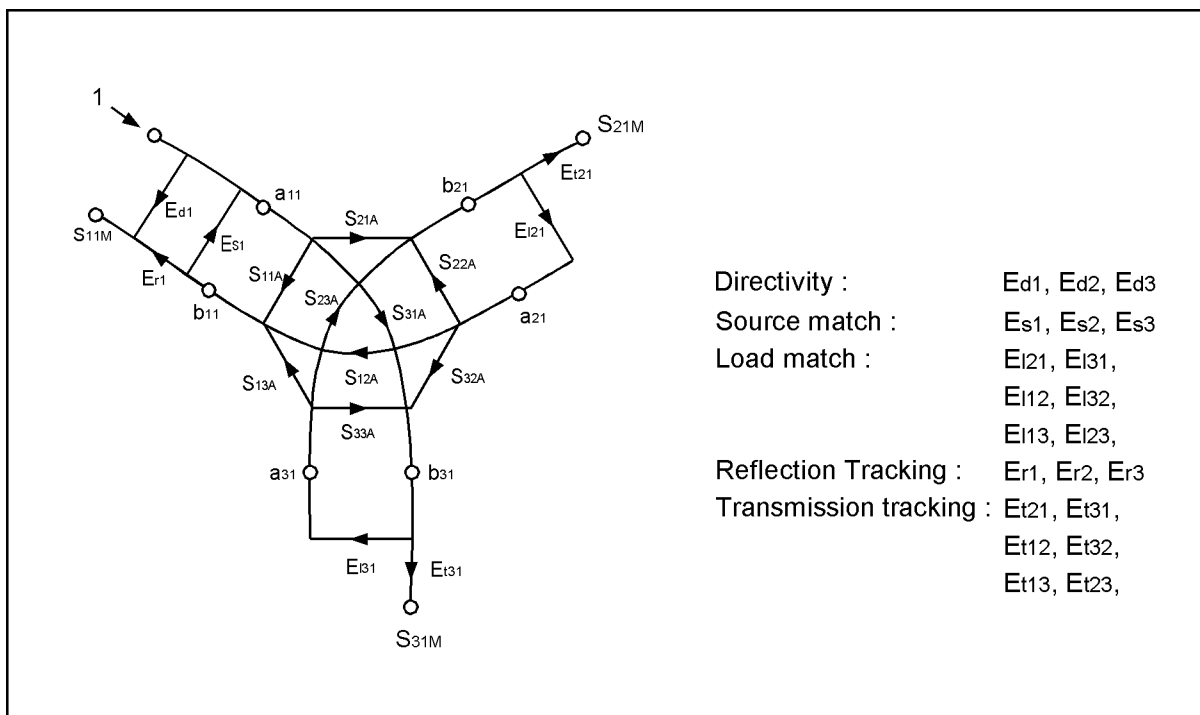

e5070bue8007

Figure 4-33 Connection of standards in 3-port TRL calibration

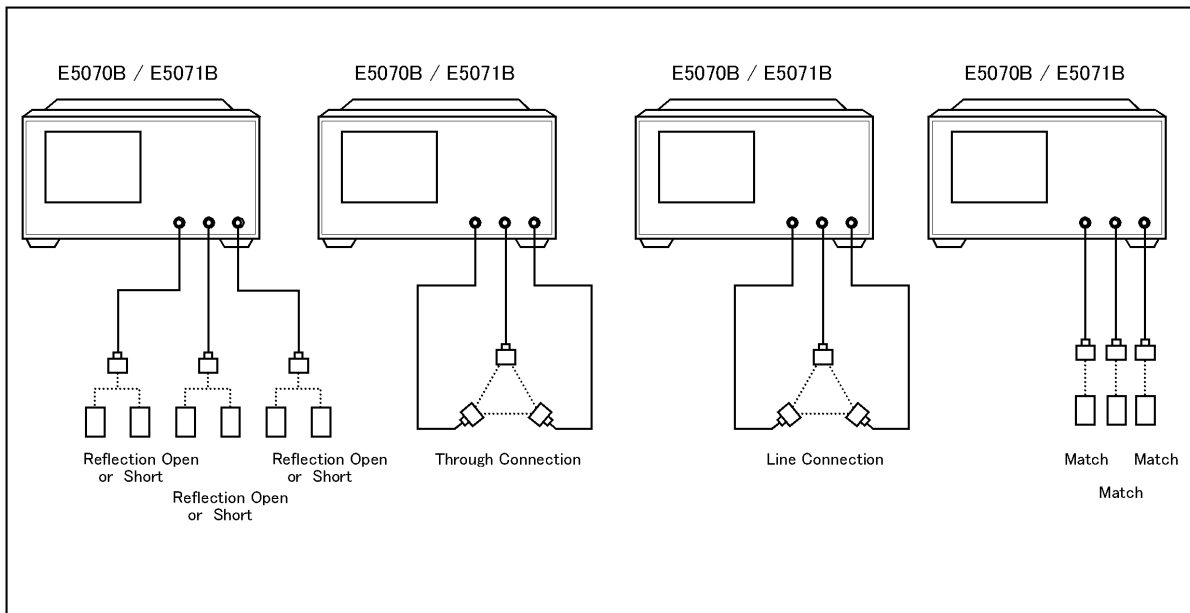

Operational procedure

NOTE

The shapes of actual standards differ from those shown in Figure 4-33 which are just symbols for illustration.

- Step 1.** Press **Channel Next** or **Channel Prev** to select the channel for which you want to execute calibration.
- Step 2.** Press **Cal**.
- Step 3.** Press **Calibrate**.
- Step 4.** Press **3-Port TRL Cal**.
- Step 5.** Press **Select Ports**.
- Step 6.** Select test ports for which you want to execute TRL 3-port calibration. (In the following procedure, test ports you select here are expressed as test ports x, y, and z.)

Softkey	Function
1-2-3	Selects test ports 1, 2, and 3.
1-2-4	Selects test ports 1, 2, and 4.
1-3-4	Selects test ports 1, 3, and 4.
2-3-4	Selects test ports 2, 3, and 4.

NOTE

An asterisk (*) in the upper right of the softkey indicates that a calibration coefficient exists that will be cleared if you select the test port and execute acquisition of the calibration

Calibration

3-port TRL calibration

coefficient (by pressing **Done**).

Step 7. Thru/Line to start the measurement of the calibration standard.

Softkey	Function
Port x-y Thru	Executes thru/line calibration for test ports x and y.
Port x-z Thru	Executes thru/line calibration for test ports x and z.
Port y-z Thru	Executes thru/line calibration for test ports y and z.

Step 8. Reflect to start the measurement of the calibration standard.

Softkey	Function
Port x Reflect	Executes reflection calibration for test port x.
Port y Reflect	Executes reflection calibration for test port y.
Port z Reflect	Executes reflection calibration for test port z.

Step 9. Line/Match to start the measurement of the calibration standard.

Softkey	Function
x-y Line/Match ^{*1}	Executes line/match calibration for test ports x and y. Use this to perform forward-direction measurement and reverse-direction measurement at the same time.
x-y Fwd (Syx) ^{*2}	Executes line/match calibration for test ports x and y. Use this to perform forward-direction measurement only.
x-y Rvs (Sxy) ^{*2}	Executes line/match calibration for test ports x and y. Use this to perform reverse-direction measurement only.
x-z Line/Match	Executes line/match calibration for test ports x and z. Use this to perform forward-direction measurement and reverse-direction measurement at the same time.
x-z Fwd (Szx)	Executes line/match calibration for test ports x and z. Use this to perform forward-direction measurement only.
x-z Rvs (Sxz)	Executes line/match calibration for test ports x and z. Use this to perform reverse-direction measurement only.
y-z Line/Match	Executes line/match calibration for test ports y and z. Use this to perform forward-direction measurement and reverse-direction measurement at the same time.
y-z Fwd (Szy)	Executes line/match calibration for test ports y and z. Use this to perform forward-direction measurement only.
y-z Rvs (Syz)	Executes line/match calibration for test ports y and z. Use this to perform reverse-direction measurement only.

*1. This is equivalent to measuring **x-y Fwd (Syx)** and **x-y Rvs (Sxy)**.

*2. Measuring **x-y Fwd (Syx)** and **x-y Rvs (Sxy)** is equivalent to measuring **x-y Line/Match**.

Step 10. Press **Done** to finish TRL 3-port calibration. At this point, the calibration coefficient is calculated and saved. The error correction function is automatically turned on.

4-port TRL calibration

The 4-port TRL calibration function lets you measure calibration data by connecting thru, reflection (open or short), line, or match calibration standards to (between) 4 test ports. This calibration provides the most accurate measurement for non-coaxial parts, using 48 error terms in total for calibration in the same way as full 4-port calibration.

NOTE

This function is available with firmware version A.06.00 or later. For firmware version A.06.00 or earlier, you can use VBA macros to define/save calibration kits and execute calibration. For more information, see Appendix A, “Manual Changes,” on page 583.

Before executing TRL calibration, you need to modify the calibration kit definition you use (or create a new one). For more information, see “Changing the Calibration Kit Definition” on page 181.

Figure 4-34 4-port TRL error model (options 413, 414)

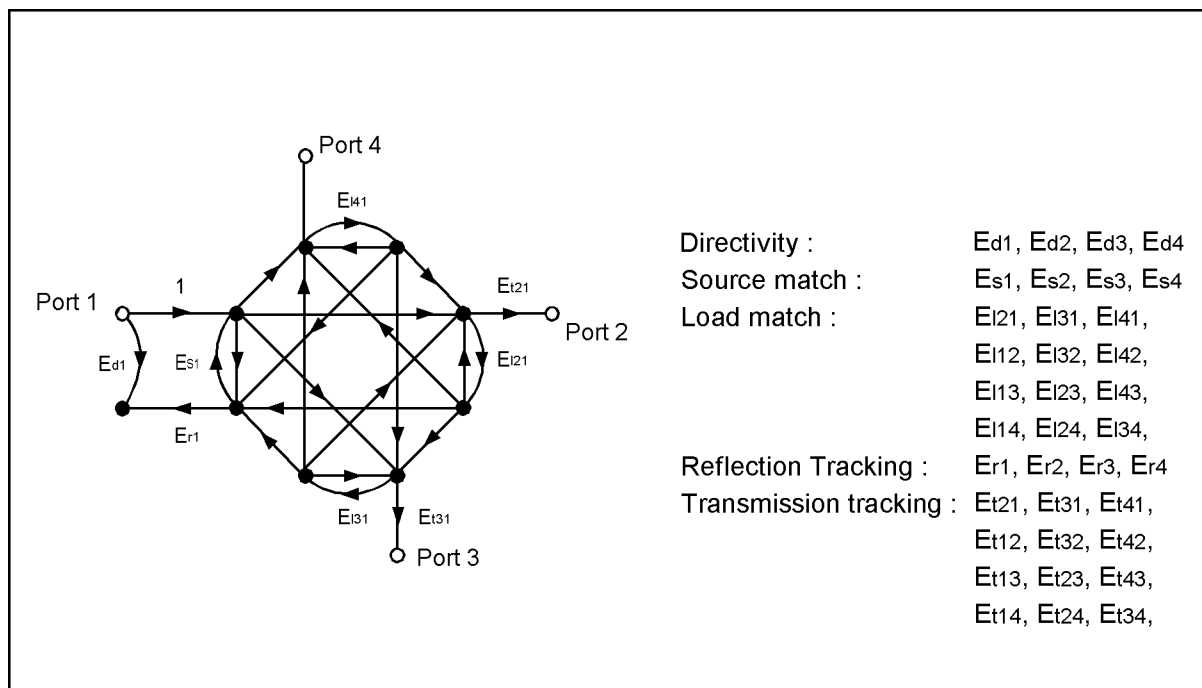

e5070bue8008

Figure 4-35 Connection of standards in 4-port TRL calibration

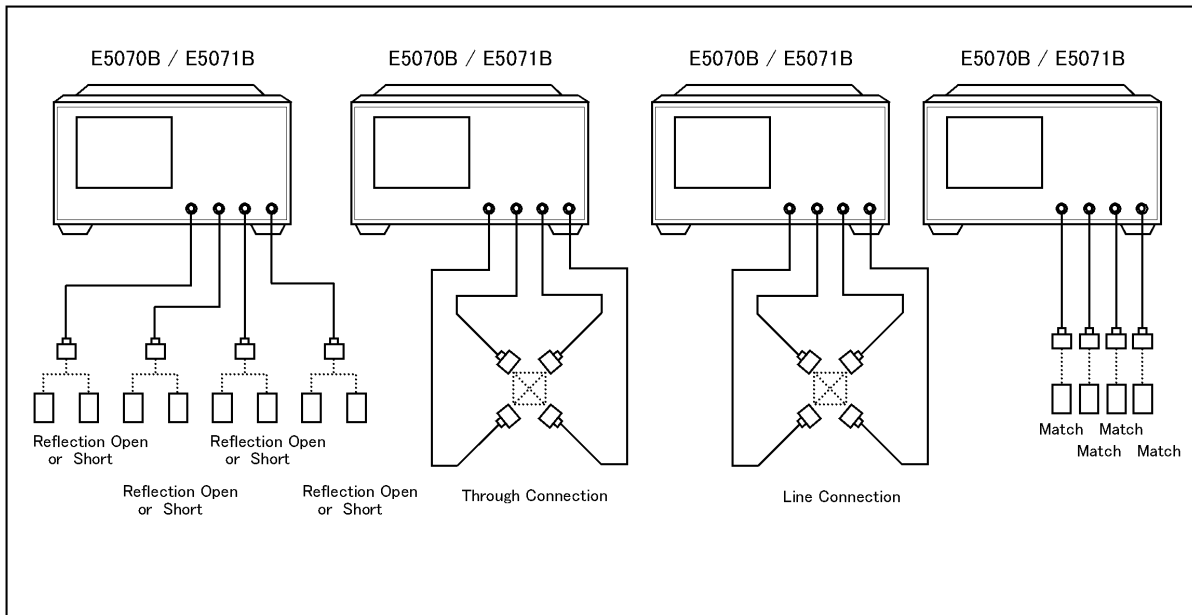

e5070bue8005

Operational procedure

NOTE

The shapes of actual standards differ from those shown in Figure 4-35 which are just symbols for illustration.

- Step 1.** Press **Channel Next** or **Channel Prev** to select the channel for which you want to execute calibration.
- Step 2.** Press **Cal**.
- Step 3.** Press **Calibrate**.
- Step 4.** Press **4-Port TRL Cal**.
- Step 5.** Press **Select Ports**.
- Step 6.** **Thru/Line** to start the measurement of the calibration standard.

Softkey	Function
Port 1-2 Thru	Executes thru/line calibration for test ports 1 and 2.
Port 1-3 Thru	Executes thru/line calibration for test ports 1 and 3.
Port 1-4 Thru	Executes thru/line calibration for test ports 1 and 4.
Port 2-3 Thru	Executes thru/line calibration for test ports 2 and 3.
Port 2-4 Thru	Executes thru/line calibration for test ports 2 and 4.
Port 3-4 Thru	Executes thru/line calibration for test ports 3 and 4.

Calibration

4-port TRL calibration

Step 7. Reflect to start the measurement of the calibration standard.

Softkey	Function
Port 1 Reflect	Executes reflection calibration for test port 1.
Port 2 Reflect	Executes reflection calibration for test port 2.
Port 3 Reflect	Executes reflection calibration for test port 3.
Port 4 Reflect	Executes reflection calibration for test port 4.

Step 8. Line/Match to start the measurement of the calibration standard.

Softkey	Function
1-2 Line/Match * ¹	Executes line/match calibration for test ports 1 and 2. Use this to perform forward-direction measurement and reverse-direction measurement at the same time.
1-2 Fwd (S21) * ²	Executes line/match calibration for test ports 1 and 2. Use this to perform forward-direction measurement only.
1-2 Rvs (S12) * ²	Executes line/match calibration for test ports 1 and 2. Use this to perform reverse-direction measurement only.
1-3 Line/Match	Executes line/match calibration for test ports 1 and 3. Use this to perform forward-direction measurement and reverse-direction measurement at the same time.
1-3 Fwd (S31)	Executes line/match calibration for test ports 1 and 3. Use this to perform forward-direction measurement only.
1-3 Rvs (S13)	Executes line/match calibration for test ports 1 and 3. Use this to perform reverse-direction measurement only.
1-4 Line/Match	Executes line/match calibration for test ports 1 and 4. Use this to perform forward-direction measurement and reverse-direction measurement at the same time.
1-4 Fwd (S41)	Executes line/match calibration for test ports 1 and 4. Use this to perform forward-direction measurement only.
1-4 Rvs (S14)	Executes line/match calibration for test ports 1 and 4. Use this to perform reverse-direction measurement only.
2-3 Line/Match	Executes line/match calibration for test ports 2 and 3. Use this to perform forward-direction measurement and reverse-direction measurement at the same time.
2-3 Fwd (S32)	Executes line/match calibration for test ports 2 and 3. Use this to perform forward-direction measurement only.
2-3 Rvs (S23)	Executes line/match calibration for test ports 2 and 3. Use this to perform reverse-direction measurement only.
2-4 Line/Match	Executes line/match calibration for test ports 2 and 4. Use this to perform forward-direction measurement and reverse-direction measurement at the same time.

Softkey	Function
2-4 Fwd (S42)	Executes line/match calibration for test ports 2 and 4. Use this to perform forward-direction measurement only.
2-4 Rvs (S24)	Executes line/match calibration for test ports 2 and 4. Use this to perform reverse-direction measurement only.
3-4 Line/Match	Executes line/match calibration for test ports 3 and 4. Use this to perform forward-direction measurement and reverse-direction measurement at the same time.
3-4 Fwd (S43)	Executes line/match calibration for test ports 3 and 4. Use this to perform forward-direction measurement only.
3-4 Rvs (S34)	Executes line/match calibration for test ports 3 and 4. Use this to perform reverse-direction measurement only.

*1. This is equivalent to measuring **1-2 Fwd (S21)** and **1-2 Rvs (S12)**.

*2. Measuring **1-2 Fwd (S21)** and **1-2 Rvs (S12)** is equivalent to measuring **1-2 Line/Match**.

Step 9. Press **Done** to finish TRL 4-port calibration. At this point, the calibration coefficient is calculated and saved. The error correction function is automatically turned on.

Simplified calibration

The simplified calibration calculates the calibration coefficients by skipping part of thru measurement (and line measurement for TRL measurement) that is necessary for the full 3/4-port calibration and the 3/4-port TRL calibration.

Simplified full 3/4-port calibration

In the simplified full 3/4-port calibration, since the calibration coefficients are calculated while omitting part of the thru measurement data, the effect of errors when acquiring calibration data becomes larger than in the normal full 3/4-port calibration. Therefore, you must pay special attention to the following points when measuring data for the simplified full 3/4-port calibration.

- o The standard used for measurement must match its definition value.
 - Use a standard that provides good repeatability (stability).
 - Do not omit the length of the thru when defining the standard.
 - When using a user-created standard, verify the definition value.
 - For the N connector, note the discrimination between male and female.
- o Realize high reliability and repeatability for measurement.
 - Reduce the difference in external environment (such as temperature difference) between conditions of measuring calibration data and conditions of measuring actual data.
 - Set the power level of the stimulus signal to a value that does not generate compression.
 - Narrow the IF bandwidth.
 - Increase the averaging factor.
 - Use a cable whose change in amplitude/phase characteristics when bent is small.
 - Use high-precision connectors.

The types of thru measurement you can omit are determined by the ports you select. Some types of thru measurement cannot be omitted. The table below shows the types of thru measurement that can be omitted.

Table 4-2

Types of thru measurement that can be omitted for simplified full 3-port calibration

Ports used	Types of thru measurement that can be omitted
Ports 1, 2, 3	2-3
Ports 1, 2, 4	2-4
Ports 1, 3, 4	1-4
Ports 2, 3, 4	2-4

NOTE For the simplified full 3-port calibration, (Optional) is displayed on the softkey of the type of thru measurement that can be omitted. For example, when the omissible thru measurement is 2-3, **2-3 (Optional)** is displayed. The display after the execution of the omissible thru measurement is the same as that for a required thru measurement.

Table 4-3 **Types of thru measurement that can be omitted for simplified full 4-port calibration**

Required thru measurements	Types of thru measurement that can be omitted
1-2, 1-3, 3-4	1-4, 2-3, 2-4

NOTE For the simplified full 4-port calibration, (Recommended) is displayed on the softkey of the type of thru measurement that can be omitted. For example, when the omissible thru measurement is 2-3, **2-3 (Recommended)** is displayed. The display after the execution of the omissible thru measurement is the same as that for a required thru measurement, and the display for the remaining omissible thru measurement is **2-3 (Optional)**.

For the simplified full 4-port calibration, up to three thru measurements can be omitted, but it is recommended to perform two or more types of calibration because omitting all of them results in poor accuracy.

Simplified 3/4-port TRL calibration

In the simplified 3/4-port TRL calibration, because the calibration coefficients are calculated while omitting part of the thru/line measurement data and line/match measurement data, the effect of errors when acquiring calibration data becomes larger than in the normal 3/4-port TRL calibration. Therefore, you must give more attention to data measurement for the simplified full 3/4-port calibration than for the ordinary 3/4-port TRL calibration. For details, refer to “Simplified full 3/4-port calibration” on page 148.

The types of thru/line measurement and line/match measurement you can omit are determined by the ports you select. Some types of measurement cannot be omitted. You cannot omit thru/line measurement only or line/match measurement only, even for an omissible measurement path.

The table below shows omissible measurements.

Table 4-4 **Omissible measurements for simplified 3-port TRL calibration**

Ports used	Omissible measurement
Ports 1, 2, 3	2-3
Ports 1, 2, 4	2-4
Ports 1, 3, 4	1-4
Ports 2, 3, 4	2-4

NOTE For the simplified 3-port TRL calibration, (Optional) is displayed on the softkey of the omissible thru/line measurement. For example, when the omissible thru/line measurement

Calibration
Simplified calibration

is 2-3, **2-3 (Optional)** is displayed. The display after the execution of the omittable thru/line measurement is **2-3 Thru/Line**.

For the softkey of an omittable line/match measurement, (Optional) is displayed as in the case of the omittable thru/line measurement. For example, when the omittable line/match measurement is 2-3, **2-3 (Optional)** is displayed. The display after the execution of the omittable line/match measurement is **2-3 Line/Match**.

The softkeys (Fwd and Rvs) for forward measurement and reverse measurement for the omittable line/match measurement do not change.

Table 4-5

Required measurements and omittable measurements for simplified 4-port TRL calibration

Required measurements	Omittable measurements
1-2, 1-3, 3-4	1-4, 2-3, 2-4

NOTE

For the simplified 4-port TRL calibration, (Recommended) is displayed on the softkey of the omittable thru/line measurement. For example, when the omittable thru/line measurement is 2-3, **2-3 (Recommended)** is displayed. The display after the execution of the omittable thru/line measurement is **2-3 Thru/Line**, and the display for the remaining omittable thru/line measurement is **2-3 (Optional)**.

For the softkey of an omittable line/match measurement, (Recommended) is displayed as in the case of the omittable thru/line measurement. For example, when the omittable line/match measurement is 2-3, **2-3 (Recommended)** is displayed. The display after the execution of the omittable line/match measurement is **2-3 Line/Match**, and the display for the remaining omittable line/match measurement is **2-3 (Optional)**.

The softkeys (Fwd and Rvs) for forward measurement and reverse measurement for the omittable line/match measurement do not change.

For the simplified 4-port TRL calibration, up to three thru/line measurements and line/match measurements can be omitted, but omitting all of them results in poor accuracy.

Partial overwrite

The partial overwrite function is used to perform partial measurement after the execution of calibration, and it overwrites the calibration coefficients.

There are three types of calibration coefficients: Er, Es, Ed for reflection, Et for transmission, and Ex for isolation. If some of them do not provide satisfactory calibration, you can use this function to re-calculate the calibration coefficients by measuring an applicable standard only instead of measuring all standards again.

NOTE

When the calibration coefficients become inappropriate over time or the status on the E5070B/E5071B side from the calibration surface changes due to replacement of a cable or connector, you need to also perform thru measurement when partial overwrite is required for reflection or isolation measurement.

NOTE

Partial overwrite is not available if no calibration has been done. You cannot append calibration coefficients to previous calibrations. For example, you cannot realize full 4-port calibration by performing additional calibration for 1 port after the execution of full 3-port calibration. The partial overwrite function is used to make measurements for previous calibration coefficients and overwrite them.

Procedure

Follow these steps to execute the partial overwrite function. The example demonstrates re-calibration for full 2-port thru calibration.

- Step 1.** Press **Channel Next** or **Channel Prev** to select the channel for which you want to execute re-calibration.
- Step 2.** Press **Cal**.
- Step 3.** Press **Calibrate**.
- Step 4.** Press **2-Port Cal**.
- Step 5.** Press **Select Ports**.
- Step 6.** Select the test ports for which you want to perform re-calibration for full 2-port calibration. (In the following procedure, the test ports you select are expressed as test ports x and y.)

Softkey	Function
1-2	Selects test ports 1 and 2.
1-3	Selects test ports 1 and 3.
1-4	Selects test ports 1 and 4.
2-3	Selects test ports 2 and 3.
2-4	Selects test ports 2 and 4.
3-4	Selects test ports 3 and 4.

Calibration

Partial overwrite

- Step 7.** Press **Transmission**.
- Step 8.** Make a thru connection between test ports x and y (between the connectors to which the DUT is connected) selected in Step 6.
- Step 9.** Press **Port x-y Thru** (x and y are the thru-connected port numbers) to start the re-measurement of the calibration standard.
- Step 10.** Press **Return**.
- Step 11.** Press **Overwrite** to finish the re-calibration for the full 2-port calibration. At this point, the calibration coefficients are re-calculated and saved.

Improving accuracy of measurement using partial overwrite (thru calibration) along with ECal

Inaccuracy caused by the ECal thru calibration standard can be reduced by performing thru measurement with the calibration kit and partial overwrite after the execution of full N-port calibration with ECal.

For example, follow these steps for full 2-port calibration.

- Step 1.** Execute full 2-port calibration according to the procedure of “Full 3-Port and Full 4-Port Calibration using 2-Port ECal” on page 132 and save the calibration coefficients.
- Step 2.** Execute steps from Step 2 to Step 11 of “Partial overwrite” with the thru standard of the calibration kit.

Unknown Thru Calibration

Unknown Thru Calibration is the preferred THRU method of calibrating the E5070B/E5071B to measure a non-insertable device. The major benefits of using a unknown thru calibration are :

- It is easy to perform.
- Provides better accuracy than defined thru and is usually better than adapter removal.
- Does not rely on existing standard definitions that may no longer be accurate.
- Causes minimal cable movement if the Thru standard has the same footprint as the DUT. In fact, the DUT can often be treated as the Thru standard.

The thru must satisfy the following requirements:

1. Thru must be reciprocal (with S21 and S12 equal) in nature. It should have a consistent behavior, independent of the direction from which it is used.
2. The electrical length of the thru should be known at an accuracy of $\pm 1/4$ of wavelength.

NOTE

Unknown Thru is NOT supported during a TRL calibration.

Procedure

The s-parameter of a thru can be determined when the following data is available:

1. Open, Short and Load measurement.
2. Actual, values derived from the calibration kit definitions.

To perform the Unknown Thru Calibration, follow the given procedure.

Procedure to select and define the name of the calibration kit

- Step 1.** Press .
- Step 2.** Press **CalKit**.
- Step 3.** Select desired calibration kit. (e.g. 85033D or user kit)
- Step 4.** Press **Modify CalKit**.
- Step 5.** Press **Define STDs**.
- Step 6.** Press **No Name**.
- Step 7.** Press **Label**.
- Step 8.** Type a name for unknown thru calibration standard. (e.g. Unknown Thru)

NOTE

By changing the label to a different name (e.g. Unknown Thru1), the “No Name” standard will adopt the specified new name.

Calibration

Unknown Thru Calibration

Procedure to select the standard type and define the standard factor

- Step 1. Press .
- Step 2. Press **Modify Calkit**.
- Step 3. Press **Define STDs**.
- Step 4. Press **{Defined Name}**.
- Step 5. Press **STD Type**.
- Step 6. Press **Unknown Thru**.
- Step 7. Press **Offset Delay**, then enter approximate offset delay value of the unknown thru standard.

Procedure to define the unknown thru

- Step 1. Press .
- Step 2. Press **Modify Calkit**.
- Step 3. Press **Specify CLSs**.
- Step 4. Press **Thru**.
- Step 5. Press **Set All**.
- Step 6. Press **{Defined Name}**.

NOTE Different unknown thru can be used for different ports.

Procedure to perform the unknown thru

- Step 1. Press .
- Step 2. Press **Calibrate**.
- Step 3. Press **n-Port Cal***1.
- Step 4. Press **Transmission**.
- Step 5. Press **{Defined Name}** to execute mechanical unknown thru calibration.
- Step 6. Complete Reflection, and Isolation (optional) for n-full port calibration.

*1. The 1-port calibration is not available.

Calibration between Ports of Different Connector Types

When you perform calibration between ports of different connector types, you need to use a different calibration kit for each test port. In addition, for transmission measurement between 2 ports, you need to use adapters suitable for the connector types of both ports.

For example, in order to perform full 2-port calibration between port 1 of an N-type connector and port 2 of a 3.5-mm connector, you need to use an N-type connector calibration kit (for example, 85032F) for reflection measurement of port 1, a 3.5-mm connector calibration kit (for example, 85033E) for reflection measurement of port 2, and an N-3.5-mm adapter for transmission measurement between ports 1 and 2.

Because you cannot use a different calibration kit for each port in normal calibration of the E5070B/E5071B, you need to use the following VBA macro to perform calibration between ports of different connector types.

Storage folder	VBA macro name (project name)
D:\Agilent	AdapterCharacterization.vba

NOTE

Never delete this VBA macro, since even system recovery cannot restore it.

This VBA macro lets you select a calibration kit for each test port and each pair of test ports when performing calibration. In addition, it lets you select any adapter (2-port Touchstone file) whose characteristics have been determined for a standard between test ports.

NOTE

This VBA macro has an adapter characterization function to obtain the characteristics of an adapter and save them to a 2-port Touchstone file. For more information, see “Adapter Characterization” on page 160.

Operating procedure

NOTE

This VBA macro changes the definition of the label of calibration kit 10 (calibration kit corresponding to the lowest softkey) temporarily, performs calibration, and restores the previous definition after completing calibration. Therefore, if the VBA macro is aborted for some reason, the definition of calibration kit 10's label may be lost.

When you use this VBA macro, it is recommended that you do not use calibration kit 10. If you are, you should back up calibration kit 10 before using the VBA macro.

To back up a calibration kit, use the VBA macro "SavRecCalKit.vba". You can download this VBA macro from our product information Web site established for the Agilent Technologies E5070B/E5071B.

1. Setting Stimulus Condition

Set the stimulus condition of the channel for which you will perform the calibration.

For information on the setting procedure, see Chapter 3, "Setting Measurement Conditions."

2. Starting VBA Macro

Load the VBA project and run it.

- Step 1.** Press **Macro Setup**.
- Step 2.** Press **Load Project**.
- Step 3.** The Open dialog box appears. Specify the file name "D:\Agilent\AdapterCharacterization.vba" and press **Open**.
- Step 4.** Press **Macro Run** to start the macro (Figure 4-36).

Figure 4-36

Adapter Characterization macro

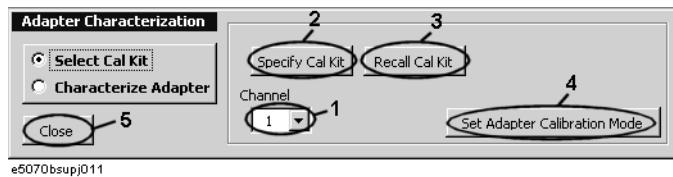

3. Selecting a Channel

Select a channel (1 in Figure 4-36).

NOTE

The selected channel has no relation to the active channel.

4. Setting Calibration Kit

Select a calibration kit for each test port and each pair of test ports and select a standard to use for each reflection/transmission measurement.

Step 1. Press **Specify Cal Kit** (2 in Figure 4-36).

The Specify Cal Kit dialog box (Reflection tab) shown in Figure 4-37 appears.

Figure 4-37

Specify Cal Kit dialog box (Reflection tab)

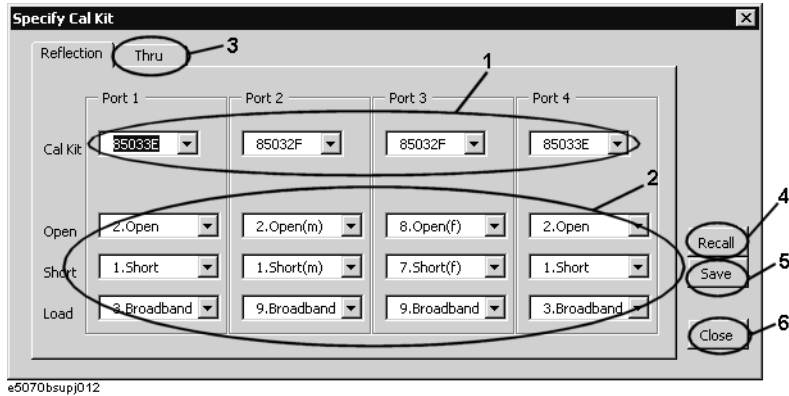

Step 2. For each test port, select a calibration kit (1 in Figure 4-37) and a standard to use in the open/short/load reflection measurements from the calibration kits (2 in Figure 4-37).

Step 3. Select the **Thru** tab (3 in Figure 4-37). The Specify Cal Kit dialog box (Thru tab) shown in Figure 4-38 appears.

Figure 4-38

Specify Cal Kit dialog box (Thru tab)

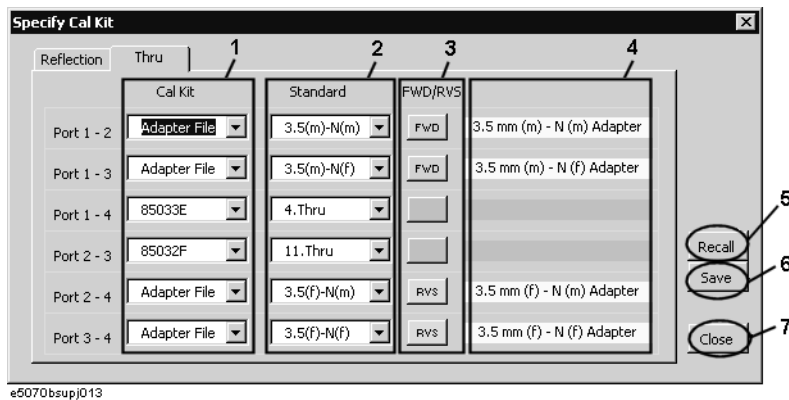

Step 4. For each test port, select a calibration kit (1 in Figure 4-38). In addition to the 10 calibration kits you can select for normal calibration, you can also select Adapter File. When you want to use the adapter as the standard, select Adapter File.

From the calibration kits you have selected, select a standard to use for transmission measurement (2 in Figure 4-38). If you select Adapter File as the calibration kit, you can select an adapter file (2-port Touchstone file) under the D:\Agilent\Data\AdapterCharacterization folder as the standard. In this case, you have to specify the port connection mode (FWD/RVS) between the E5070B/E5071B and the

Calibration

Calibration between Ports of Different Connector Types

adapter (3 in Figure 4-38).

FWD	Port 1 of the adapter (port 1 of the 2-port Touchstone file) is connected to the test port of the smaller port number of the E5070B/E5071B.
RVS	Port 2 of the adapter (port 2 of the 2-port Touchstone file) is connected to the test port of the smaller port number of the E5070B/E5071B.

For example, when setting ports 2 to 4, if you want to connect port 1 of the adapter to test port 4 of the E5070B/E5071B and port 2 of the adapter to test port 2 of the E5070B/E5071B, select RVS as the port connection mode.

When you select Adapter File, the comment contained in the adapter file is displayed at 4 in Figure 4-38.

NOTE

If the system Z0 written in the adapter file is different from the system Z0 of the E5070B/E5071B, “file error” is displayed at 4 in Figure 4-38. In this case, you cannot set the E5070B/E5071B to the adapter calibration mode.

Saving and loading calibration kit settings

You can save the selection of the calibration kit and standard for each test port (the setting in the Reflection tab) and that for each pair of test ports (the setting in the Thru tab), as well as load them for restoring whenever needed.

Press the **Save** button (5 in Figure 4-37 or 6 in Figure 4-38) to save the setting to a file.

Press the **Recall** button (4 in Figure 4-37 or 5 in Figure 4-38) or the **Recall Cal Kit** button (3 in Figure 4-36) to recall the setting from the file.

NOTE

If the calibration kit definition is changed after saving the file, resulting in a contradiction between the information in the file and that in the calibration kit definition, you can no longer recall the settings from the file.

Step 5. Press **Close** (6 in Figure 4-37 or 7 in Figure 4-38) to finish the setting of the calibration kits.

5. Performing Calibration

Set the E5070B/E5071B to the special calibration mode in which you can use a different calibration kit for each test port (adapter calibration mode), then perform the calibration.

Step 1. Press **Set Adapter Calibration Mode** (4 in Figure 4-36) to set the E5070B/E5071B to the adapter calibration mode.

NOTE

Do not terminate the VBA macro by force.

In the adapter calibration mode, if you terminate the VBA macro forcefully, for example, with the **Macro Break** key before returning to the normal calibration mode with the **Exit** button, normal calibration can no longer be performed and the label of calibration kit 10 remains altered. To return to the normal calibration mode, restart the firmware of the E5070B/E5071B. In this case, you cannot restore the label of calibration kit 10.

Step 2. The screen showing the selected calibration kits for each test port and each pair of test ports

based on the setting in “4. Setting Calibration Kit” on page 157 appears (Figure 4-39).

Figure 4-39

Display of calibration kit setting for adapter calibration mode

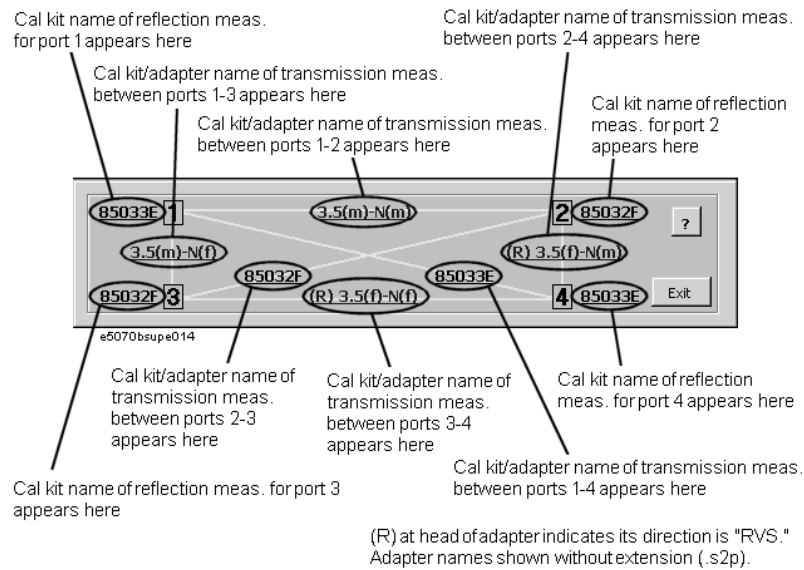

The calibration procedure in the adapter calibration mode is the same as that in the normal calibration except that the standard connected for each calibration data measurement differs. Therefore, when performing this calibration, you must use the same softkeys (the menu displayed by **Cal** - **Calibrate**) you used in the normal calibration.

In the adapter calibration mode, the standard name is displayed in the softkey to perform each calibration data measurement based on the setting in “4. Setting Calibration Kit” on page 157.

Following the on-screen information in Figure 4-39 and the softkey label, connect the appropriate standard and measure each type of calibration data to perform calibration.

Step 3. After calibration, press **Exit** to return the E5070B/E5071B to the normal calibration mode.

6. Closing VBA Macro

Press **Close** (5 in Figure 4-36) to close the macro.

Adapter Characterization

To perform calibration between ports of different connector types, you have to obtain the characteristics of the adapter for use in transmission measurement in advance.

The adapter characterization function lets you obtain the adapter's characteristics (S-parameters) and save them to a 2-port Touchstone file.

Use the following VBA macro to execute the adapter characterization.

Storage folder	VBA macro name (project name)
D:\Agilent	AdapterCharacterization.vba

NOTE

Never delete this VBA macro, since even system recovery cannot restore it.

Concept

Adapter characterization is a function that calculates the S-parameters of an adapter based on 3 measurement results obtained by using open/short/load standards connected to the test port, via the adapter, for which 1-port calibration has been performed. This VBA macro uses test port 1 for this measurement.

The S-parameters of the adapter can be calculated from the above 3 measurement results. However, you can calculate the S-parameters more accurately by connecting the adapter to the test port in the reverse direction, measuring 3 more results in the same way as above, and using the above 3 results with the 3 new results (a total of 6 measurement results). This VBA macro uses test port 2 for the measurement made when the adapter is connected in the reverse direction.

Figure 4-40

Adapter characterization

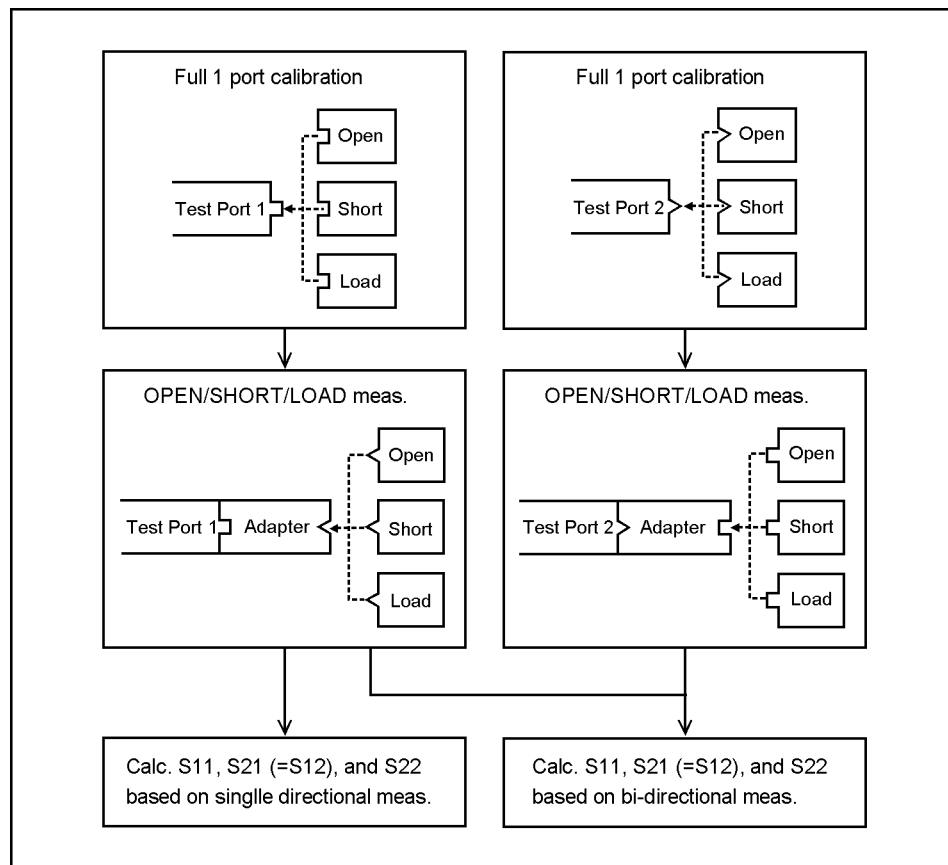

e5070bsupe015

How to execute adapter characterization

1. Setting Stimulus Conditions

Set the stimulus conditions of the channel for which you will execute the adapter characterization.

For information on the setting procedure, see Chapter 3, “Setting Measurement Conditions.”

2. Performing Calibration

Perform 1-port calibration for test port 1 and test port 2 in the channel for which the stimulus condition has been set. Use the connector type appropriate for the adapter for the calibration surface of test port 1 and test port 2.

For information on the procedure for performing this calibration, see “1-Port Calibration (reflection test)” on page 113.

3. Starting VBA Macro

- Step 1.** Press **Macro Setup**.
- Step 2.** Press **Load Project**.
- Step 3.** The Open dialog box appears. Specify the file name “D:\Agilent\AdapterCharacterization.vba” and press the **Open** button.
- Step 4.** Press **Macro Run** to start the macro.
- Step 5.** Select **Characterize Adapter** (1 in Figure 4-41) to display the Adapter Characterization screen.

Figure 4-41

Adapter Characterization macro (Adapter Characterization screen)

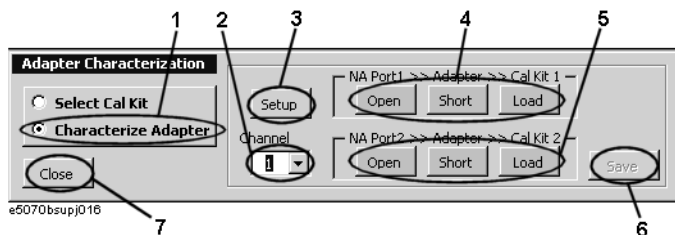

4. Selecting Channel

Select the channel for which calibration has been performed (2 in Figure 4-41).

NOTE

The selected channel has no relation to the active channel.

5. Setting Adapter Characterization

Step 1. Press **Setup** (3 in Figure 4-41). The Setup dialog box shown in Figure 4-42 appears.

Figure 4-42 Setup dialog box

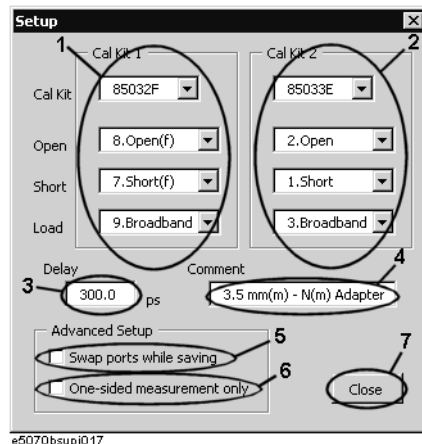

Step 2. Make the setting of the calibration kit for the adapter that is connected to test port 1 of the E5070B/E5071B in Cal Kit 1 (1 in Figure 4-42).

Step 3. Make the setting of the calibration kit for the adapter that is connected to test port 2 of the E5070B/E5071B in Cal Kit 2 (2 in Figure 4-42).

When you calculate the S-parameters using measurement data in one direction only, you do not have to make the setting in Cal Kit 2. In this case, check the box to the left of One-sided measurement Only (6 in Figure 4-42).

Step 4. Enter the Delay of the adapter (3 in Figure 4-42) within an error of $\pm \frac{1}{4 \times f}$ [s], where f is the maximum measurement frequency [Hz]. For example, when the maximum value is 1 GHz, enter a value within an error of ± 250 ps.

Step 5. Enter a comment about the adapter (4 in Figure 4-42). The comment entered here is displayed in the comment field in the Specify Cal Kit dialog box (4 in Figure 4-37).

Step 6. By default, the S-parameters are saved so that the port of the adapter connected to test port 1 of the E5070B/E5071B corresponds to port 1 of the 2-port Touchstone file. To save the S-parameters in reverse order, which means that the port of the adapter connected to test port 1 of the E5070B/E5071B corresponds to port 2 of the 2-port Touchstone file, check the box to the left of Swap ports while saving (5 in Figure 4-42).

Step 7. Press **Close** (7 in Figure 4-42) to finish setting the adapter characterization.

Calibration

Adapter Characterization

6. Measuring Data

Measure data when each standard is connected.

- Step 1.** Connect the adapter to test port 1 of the E5070B/E5071B.
- Step 2.** According to the setting of Cal Kit 1, connect each standard to the adapter and then press the corresponding button (4 in Figure 4-41). When the data measurement is complete, the button turns yellow.

When you calculate the S-parameters using measurement data in one direction only, the data measurement is complete here.

- Step 3.** Connect the adapter to test port 2 of the E5070B/E5071B in the reverse direction.
- Step 4.** According to the setting of Cal Kit 2, connect each standard to the adapter and then press the corresponding button (5 in Figure 4-41). When the data measurement is complete, the button turns yellow.

7. Saving to a File

Calculate the S-parameters and save them to a file.

- Step 1.** Press the **Save** button (6 in Figure 4-41).
- Step 2.** The Save As dialog box appears. Enter a file name and press **Save**.

If you save the file under the D:\Agilent\Data\AdapterCharacterization folder, you can select it as the standard Adapter file while setting the adapter calibration mode in the Specify Cal Kit dialog box.

8. Closing VBA Macro

Press **Close** (7 in Figure 4-41) to close the macro.

Execution procedure of characterization for test fixture using probe

The adapter characterization function also lets you obtain the characteristics of a test fixture that is inserted between the instrument and a DUT that cannot be connected directly to the instrument. In this case, a probe is used, and the obtained characteristics are saved to a 2-port Touchstone file. The obtained result can be eliminated by using the network de-embedding of the fixture simulator function, which permits measurement by eliminating the effect of the test fixture.

NOTE

For more information on test fixture characterization using a probe, see Product Note E5070/71-4.

1. Setting Stimulus Conditions

Set the stimulus condition of the channel for which you will execute the test fixture characterization.

2. Performing Calibration

Perform 1-port calibration for the probe in the channel for which the stimulus condition has been set.

3. Starting VBA Macro

Start the VBA macro to display the Adapter Characterization screen (Figure 4-41).

4. Selecting Channel

Select the channel for which calibration has been performed (2 in Figure 4-41).

5. Setting Characterization

- Step 1.** Press **Setup** (3 in Figure 4-41) to display the Setup dialog box (Figure 4-42).
- Step 2.** Make the setting of the calibration kit used in Cal Kit 1 (1 in Figure 4-42).
- Step 3.** Enter the Delay of the test fixture (3 in Figure 4-42).
- Step 4.** Enter a comment about the test fixture (4 in Figure 4-42). This comment is added to the comment line at the beginning of the Touchstone file.
- Step 5.** Check the box to the left of Swap ports while saving (5 in Figure 4-42) to align the direction when specifying a file in the network de-embedding function.
- Step 6.** Check the box to the left of One-sided measurement Only (6 in Figure 4-42).
- Step 7.** Press **Close** (7 in Figure 4-42) to close the Setup dialog box.

6. Measuring Data

- Step 1.** Connect the probe to the end of the test fixture on the DUT side.
- Step 2.** Depending on the setting of Cal Kit 1, connect each standard to the connector side of the test fixture and then press the corresponding button (4 in Figure 4-41). When the data measurement is complete, the button turns yellow.

7. Saving to file

Press the **Save** button (6 in Figure 4-41) to save the calculated S-parameters to a 2-port Touchstone file.

8. Closing VBA Macro

Press **Close** (7 in Figure 4-41) to close the macro.

Adapter Removal-Insertion

About Adapter Removal

Adapter removal is a technique used to remove any adapter characteristics from the calibration plane. Usually, 2-port network analyzers remove adapter characteristics by performing two sets of full 2-port calibration as shown below.

Figure 4-43

Adapter removal

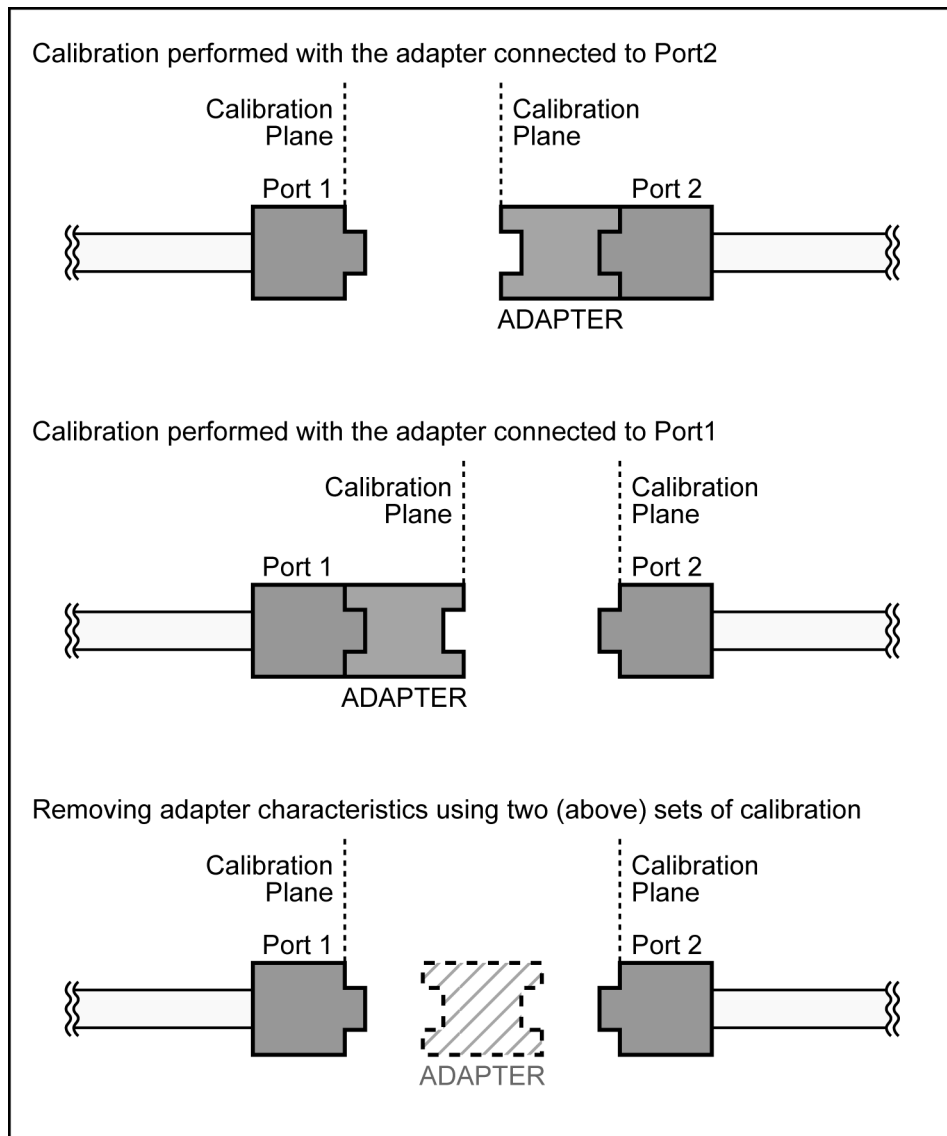

e5070bue10005

Calibration

Adapter Removal-Insertion

However, this method is not suitable for a multi-port network analyzer because it will require as many sets of full 2-port calibration as twice the number of port combinations. Hence, E5070B/E5071B uses the following adapter removal process to remove adapter characteristics.

1. Perform calibration with the adapter in use.
2. Remove the adapter from the port and measure Open, Short and Load values to determine the adapter's characteristics.
3. Remove the obtained adapter characteristics from the error coefficients in an embedding fashion.

Figure 4-44 Adapter removal for E5070B/E5071B

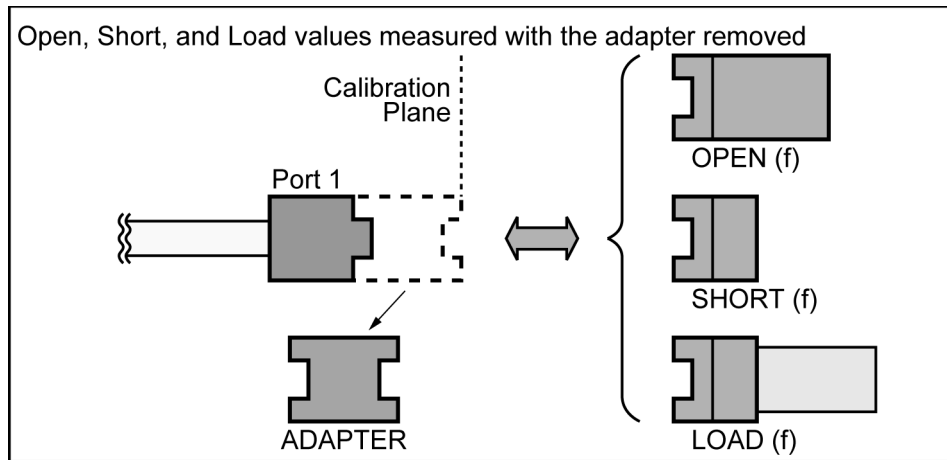

e5070bue10006

About Adapter Insertion

This above described method also makes it possible to add adapter characteristics to a port with full n-port calibration. This allows you to make a measurement with the adapter. E5070B/E5071B uses the following adapter insertion process to insert adapter characteristics.

1. Perform calibration without the adapter in use.
2. Insert the adapter to the port and measure Open, Short and Load values to determine the adapter's characteristics.
3. Insert the obtained adapter characteristics to the error coefficients in an De-embedding fashion.

In order to determine the adapter characteristics (with four unknown parameters) by making three measurements (Open, Short and Load), the adapter must satisfy the following requirements.

- Adapter must be reciprocal (with S21 and S12 equal) in nature. It should have a consistent behavior, independent of the direction from which it is used.
- The electrical length of adapter should be known at an accuracy of $\pm 1/4$ of wavelength.

Figure 4-45

Adapter insertion for E5070B/E5071B

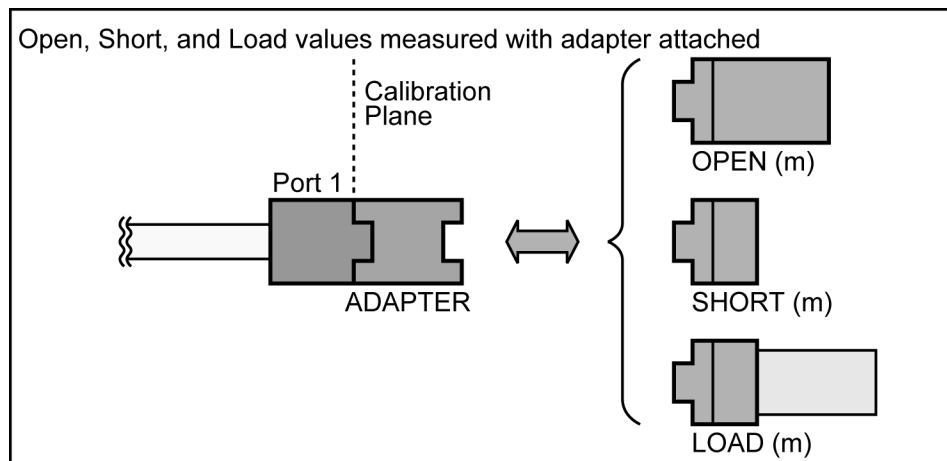

e5070bue10007

Procedure for Adapter Removal / Insertion

The s-parameter of a reciprocal adapter can be determined when the following data is available.

- Open, Short, and Load measurements.
- Actual values derived from the CalKit definitions.
- An approximate length of the adapter.
- Nature of the intended operation : removal or insertion.

Once the s-parameter has been determined, run de-embedding and update the error coefficients.

NOTE

If the frequency setting is not zero span, an approximate length of the adapter should be provided otherwise an error generated in the measurement.

Step 1. Perform a full n-port calibration.

Step 2. Press .

Step 3. Press **Calibrate**.

Step 4. Press **Adapter Removal**.

Step 5. Select the port in/from which you want to insert/remove adapter characteristics from **Select Port**.

Step 6. Press **Cal Kit**, and then select calibration kit.

Step 7. Select the adapter length.

Softkey	Function
AUTO	Adapter automatic
Positive Value	Adapter removal
Negative Value	Adapter insertion

NOTE

For adapter removal, the adapter length is positive. For adapter insertion, the adapter length is negative.

Step 8. Press **Open**, **Short**, and **Load** respectively.

Step 9. Press **Done** to complete the process.

User-characterized ECal

The E5070B/E5071B allows you to execute ECal calibration with user-defined characteristics instead of the ECal characteristics defined as the factory default. This feature is called User-characterized ECal, and it is used to execute ECal calibration when an adapter is connected to the ECal module.

Before executing the User-characterized ECal, you have to measure data, such as characteristics when the adapter is connected to the ECal module, and store them to the built-in flash memory of the ECal module as the user characteristics.

Use the following VBA macro to acquire user characteristics and store them to the ECal module's built-in memory.

Storage folder	VBA macro name (project name)
D:\Agilent	EcalCharacterization.vba

NOTE This function is available with firmware version 3.50 or higher.

NOTE Never delete this VBA macro, since even system recovery cannot restore it.

Precautions to take in using VBA macros

- o Never connect/disconnect the USB cable.
Never connect/disconnect the USB cable between the ECal module and the E5070B/E5071B while executing the VBA macro.

CAUTION In particular, the above precaution must always be observed while the VBA macro is storing data to the ECal module's built-in flash memory; disconnecting the USB cable at this time may damage the ECal module.

- o Back up the flash memory contents.
The VBA macro provides a feature to back up the contents of the ECal module's built-in flash memory. Before storing user characteristics to the ECal module, be sure to use this feature to back up the flash memory's current contents.

Storing user characteristics to the ECal module

Follow these steps to measure characteristics while an adapter is connected to the ECal module and then to store them to the ECal module's built-in flash memory as user characteristics.

NOTE

With the E5070B/E5071B with 2/3 ports (options 213, 214, 313, or 314), you cannot measure the user characteristics of a 4-port ECal module and store them into the memory by using this VBA macro.

1. Connecting ECal Module

Connect the USB cable between the USB port of the ECal module and that of the E5070B/E5071B. You can make this connection while the E5070B/E5071B's power is ON.

2. Setting Stimulus Condition

Set the stimulus condition of the channel for which you want to measure the user characteristics. For optimal accuracy, set the IF bandwidth to 1 kHz or less.

3. Executing Calibration

For the channel for which you have set the stimulus condition, execute full 4-port calibration with a 4-port ECal module or full 2-port calibration between the test ports used with a 2-port ECal module. Define the calibration surface as the connector surface connected to each port of the ECal module in the state used to measure characteristics.

For information on how to perform calibration when the connector types of individual ports differ, refer to “Calibration between Ports of Different Connector Types” on page 155.

4. Starting the VBA MACRO

- Step 1.** Press **Macro Setup**.
- Step 2.** Press **Load Project**.
- Step 3.** The Open dialog box appears. Specify the file name “D:\AgilentEcalCharacterization.vba” and press **Open**.
- Step 4.** Press **Macro Run** to start the macro. The ECal part (1 in Figure 4-46) displays the information of the ECal module connected to the E5070B/E5071B. Press **Refresh** (2 in Figure 4-46) to update the information if you have connected another ECal module after the macro has been started.

Figure 4-46

EcalCharacterization macro

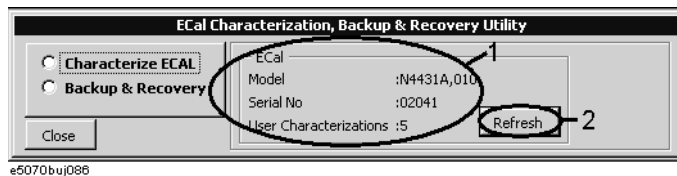

5. Measuring User Characteristics

Step 1. Select **Characterize ECAL** (1 in Figure 4-47) to display the User Characteristic Measurement screen.

Figure 4-47 EcalCharacterization macro (User Characteristic Measurement screen)

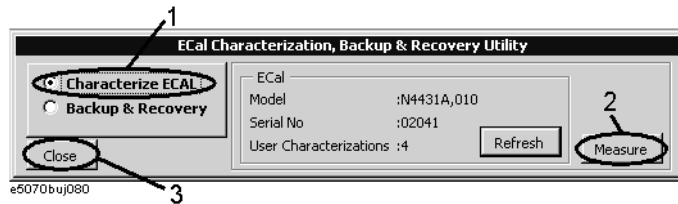

Step 2. After connecting the adapter to the ECal module as necessary, connect each port of the ECal module and the test port of the E5070B/E5071B.

Figure 4-48 Connecting ECal module (for 4 ports)

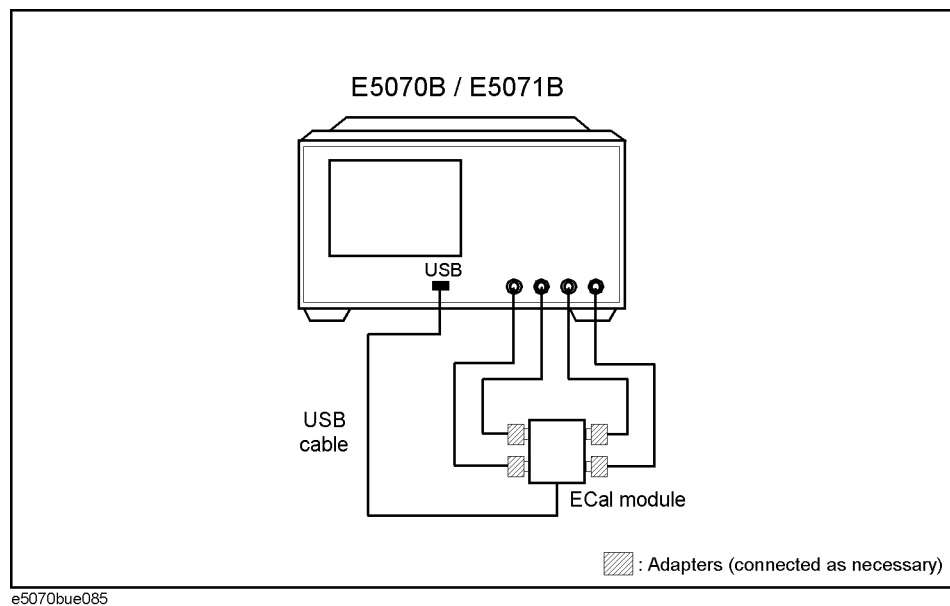

NOTE

You can select any port of the ECal module and any test port of the E5070B/E5071B for connection; the E5070B/E5071B automatically recognizes the connected ports before measurement.

Step 3. Press **Measure** (2 in Figure 4-47) to start measurement.

6. Storing the User Characteristics to the Memory

Step 1. When the measurement is complete, the User Characteristic Store screen shown in Figure 4-49 appears.

Specify a user number (a location number in the memory where you want to store the user characteristics) using 1 in Figure 4-49. If the specified location number is not used for storage, the parts Characterization, Connectors, and Adapter Description are left blank; if already used, the stored contents are displayed.

Figure 4-49

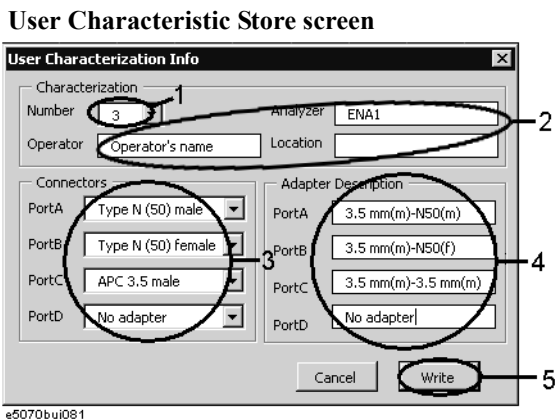

Step 2. Enter the following information.

Characterization (2 in Figure 4-49)	Enter the information (operator, used analyzer, and so on) when measuring user characteristics as necessary.
Connectors (3 in Figure 4-49)	Select the connector types of the adapters for the ECal module’s test ports. Male and female in the list of connected types indicate male and female adapter, respectively. Select “No adapter” if no adapter is used on a port.
Adapter Description (4 in Figure 4-49)	Enter the detailed information on the adapters connected to each port as necessary.

The information you have entered is displayed when checking the user characteristics information by using the key strokes: **Cal** - **E**Cal - **C**haracterization **I**nf

Step 3. Press **Write** (5 in Figure 4-49).

At this time, if user characteristics are already stored for the specified user number, a dialog appears to confirm overwriting. Click the **OK** button.

NOTE

Although the maximum number of user characteristics stored to the ECal’s memory is usually five, this number may be limited by memory size because the size of user-characteristics data is not fixed and increases in proportion to the number of measurement points. An error occurs when the **Write** button is pressed if the total size added the new user characteristics exceeds this limitation due to memory size.

Step 4. The dialog box shown in Figure 4-50 is displayed to confirm execution. Press **OK** (1 in Figure 4-50) to start storing the user characteristics.

CAUTION

Do not disconnect the USB cable or terminate the VBA macro by force while the VBA macro is storing data to the ECal's built-in flash memory. Doing so may damage the ECal module.

Figure 4-50 Execution Confirmation screen

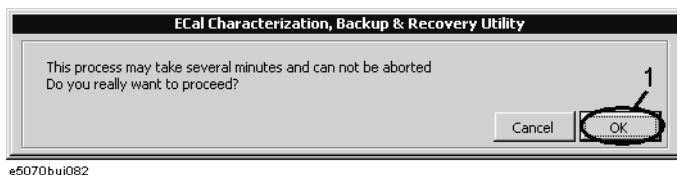

The dialog box shown in Figure 4-51 appears while the VBA macro is storing data to memory. Storing the user characteristics takes a few minutes depending on the amount of data.

Figure 4-51 Screen while macro is storing data

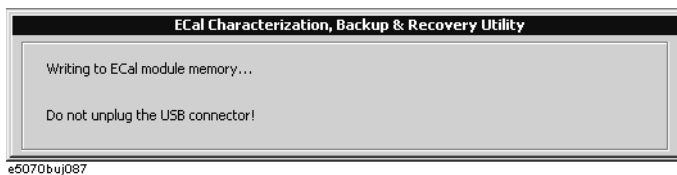

Step 5. Another dialog box is displayed to notify completion of data storage. Click **OK**.

8. Closing the VBA macro

Press **Close** (3 in Figure 4-47) to close the macro.

Backup and recovery of ECal module's built-in flash memory

Follow these steps to back up the contents of the ECal module's built-in flash memory.

- Step 1.** Connect the USB cable between the USB port of the ECal module and that of the E5070B/E5071B. You can make this connection while the E5070B/E5071B's power is ON.
- Step 2.** Start the VBA macro according to “4. Starting the VBA MACRO” on page 172.
- Step 3.** Select **Backup Flash ROM** (1 in Figure 4-52) to display the Backup screen.

Figure 4-52 EcalCharacterization macro (Backup screen)

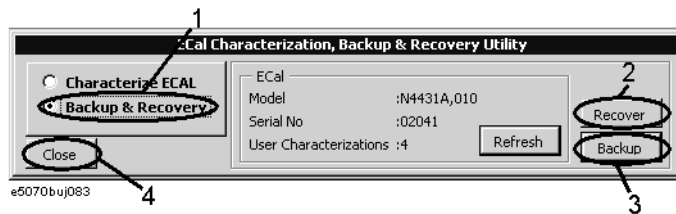

Step 4. Recovery

1. Press **Recover** (2 in Figure 4-52).
2. The Open dialog box appears. Enter the file name of the contents you want to recover and press **Open**.

If the serial number information stored in the file does not match that of the ECal module connected to the E5070B/E5071B, a confirmation dialog box appears. Press **OK** to continue the recovery only if a mismatch between these serial numbers is allowed.

3. The dialog box shown in Figure 4-50 is displayed to confirm execution. Press **OK** (1 in Figure 4-50) to start the recovery of the flash memory. The dialog box shown in Figure 4-51 appears while the VBA macro is storing data to the memory. The recovery of the flash memory takes a few minutes depending on the amount of data.

CAUTION

Do not disconnect the USB cable or terminate the VBA macro by force while the VBA macro is storing data to the ECal's built-in flash memory. Doing so may damage the ECal module.

4. The Completion screen appears. Click **OK**.

Backup

1. Press **Backup** (3 in Figure 4-52).
2. The Save As dialog box appears. Enter the name of the file you want to save and press **Save**.

- Step 5.** Press **Close** (4 in Figure 4-52) to close the macro.

Executing User-characterized ECal

The execution procedure for the User-characterized ECal is the same as for normal ECal except that it requires the user characteristics to be selected in advance.

Follow these steps to select the user characteristics.

- Step 1.** Press **Channel Next** or **Channel Prev** to select the channel for which you want to execute calibration.
- Step 2.** Press **Cal**.
- Step 3.** Press **ECal**.
- Step 4.** Press **Characterization**.
- Step 5.** Select a user characteristic according to the list below.

Softkey	Function
Factory	Factory-default characteristic (for normal ECal)
User1	User characteristic stored at location number 1 in ECal's flash memory
User2	User characteristic stored at location number 2 in ECal's flash memory
User3	User characteristic stored at location number 3 in ECal's flash memory
User4	User characteristic stored at location number 4 in ECal's flash memory
User5	User characteristic stored at location number 5 in ECal's flash memory

- Step 6.** To check the information on the user characteristics you have selected, press **Characterization Info**. The dialog box shown in Figure 4-51 appears.

Figure 4-53

ECal Characterization Information screen

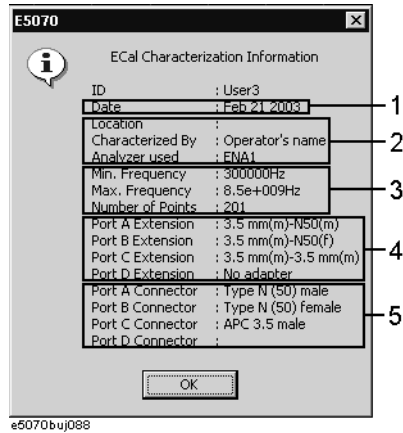

- 1: The date when the user characteristics were measured
- 2: The information you entered in Characterization (1 in Figure 4-49)
- 3: The stimulus conditions when the user characteristics were measured
- 4: The information you entered in Adapter Description (3 in Figure 4-49)
- 5: The information you entered in Connectors (2 in Figure 4-49)

Confidence Check on Calibration Coefficients Using ECal

NOTE

This function is available with firmware version 3.50 or higher.

Using the ECal module, the E5070B/E5071B lets you verify the obtained calibration coefficients to determine whether correct measurement is possible with them.

The E5070B/E5071B can set ECal to the state used to verify the measurement parameters and then copy the appropriate characteristics of that verification state to the memory trace from the ECal's built-in memory. This is done according to the measurement parameters of the active trace of the active channel. While measuring ECal in this specified state, you can compare the measurement results with those of the E5070B/E5071B and with the appropriate measurement results stored in ECal in several different ways. These include simultaneously displaying the data and memory traces or displaying the math operation results between the data and memory traces. This enables you to verify the correctness of measurement for each measurement parameter when the obtained calibration coefficients are used.

Operational procedure

Follow these steps to verify the reliability of the calibration coefficients.

- Step 1.** Connect the USB cable between the USB port of the ECal module and that of the E5070B/E5071B. You can make this connection while the E5070B/E5071B's power is ON.
- Step 2.** Press **Channel Next** or **Channel Prev** to select the channel for which you want to perform the verification.
- Step 3.** Press **Meas**.
- Step 4.** Select the S-parameter you want to verify.

NOTE

You cannot verify the mixed mode S-parameter.

- Step 5.** Connect the test ports of the E5070B/E5071B corresponding to the selected S-parameter (for example, ports 1 and 2 when the S-parameter is S21) and the ports of the ECal module.

NOTE

If you don't use all of the ECal module's ports, connect terminations to the unused ports.

NOTE

You can use any of the Ecal's ports for this connection. The connected port is automatically detected and measurement is performed.

Figure 4-54

Connecting ECal module (for verification of S21)

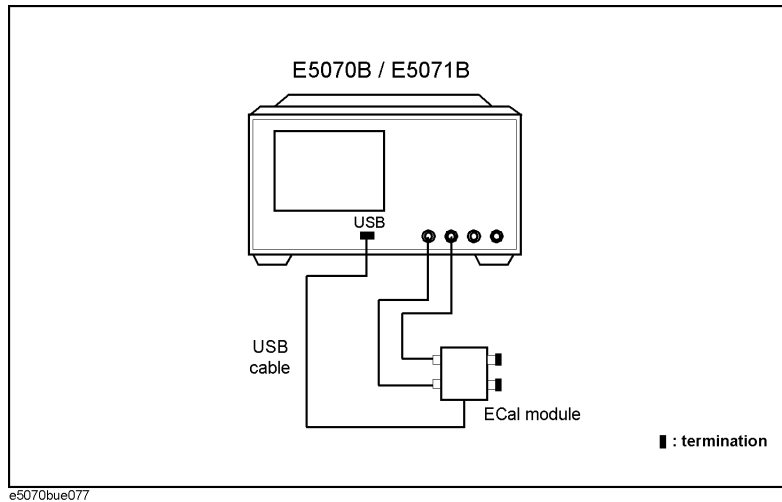

Step 6. Press **Cal**.

Step 7. Press **ECal**.

Step 8. When using an adapter to the ECal, press **Characterization** and then press the softkey corresponding to the characterization for the adapter you are using.

Step 9. Press **Confidence Check**.

Step 10. Compare the data trace and the memory trace and verify whether measurement is correct.

The following is the procedure for comparison when simultaneously displaying the data trace and the memory trace.

a. Press **Display**.

b. Press **Display**.

c. Press **Data & Mem**.

d. Press **Scale**.

e. Press **Auto Scale**.

f. Determine whether the difference between the traces is acceptable.

Step 11. For all of the parameters you want to verify, repeat Step 3 through Step 10.

Changing the Calibration Kit Definition

In most measurements, the user can use pre-defined calibration kits as they are. However, it may be necessary to change the definition of a calibration kit (or create a new one) when changing the pre-defined connector between male and female (e.g. from OPEN (f) to OPEN (m)^{*1}) or when a special standard is used or a high degree of accuracy is demanded. When it is necessary to change the definition of a calibration kit that contains a calibration device but no calibration kit model, the user must fully understand error correction and the system error model.

A user-defined calibration kit may be used in the following circumstances.

- When the user wants to use connectors other than those pre-defined in the calibration kits for the E5070B/E5071B (e.g., a SMA connector).
- When the user wants to use different standards in place of one or more standards pre-defined in the E5070B/E5071B. For example, when three offset SHORT standards are used instead of OPEN, SHORT, and LOAD standards.
- When the user wants to modify the standard model of a pre-defined calibration kit and turn it into a more accurate model. It is possible to perform better calibration if the performance of the actual standard is better reflected in the standard model. For example, you may need to define the 7-mm LOAD standard as 50.4 Ω instead of 50.0 Ω .

*1. The designations (m) and (f) in the name (label) of the standard indicate male (m) and female (f) analyzer connectors.

Definitions of terms

The terms used in this section are defined as follows:

Standard	An accurate physical device, for which the model is clearly defined, used to determine system errors. With the E5070B/E5071B, the user may define up to 21 standards per calibration kit. Each standard is numbered from 1 through 21. For example, standard 1 for the 85033E 3.5-mm calibration kit is a SHORT standard.
Standard type	The type of standard used to classify a standard model based on its form and construction. Five standard types are available: SHORT, OPEN, LOAD, delay/THRU, and arbitrary impedance.
Standard coefficient	The numeric characteristics of the standard used in the selected model. For example, the offset delay (32 ps) of the SHORT standard in the 3.5-mm calibration kit is a standard coefficient.
Standard class	A group of standards used in a calibration process. For each class, the user must select the standards to use from the 21 available standards.
Subclass	You can register up to 8 standard types. This capability lets you specify a different standard for each frequency range. You must assign standards to subclasses you use.

Defining parameters for standards

Figure 4-55 and Figure 4-56 show the parameters used in defining standards.

Figure 4-55

Reflection Standard Model (SHORT, OPEN, or LOAD)

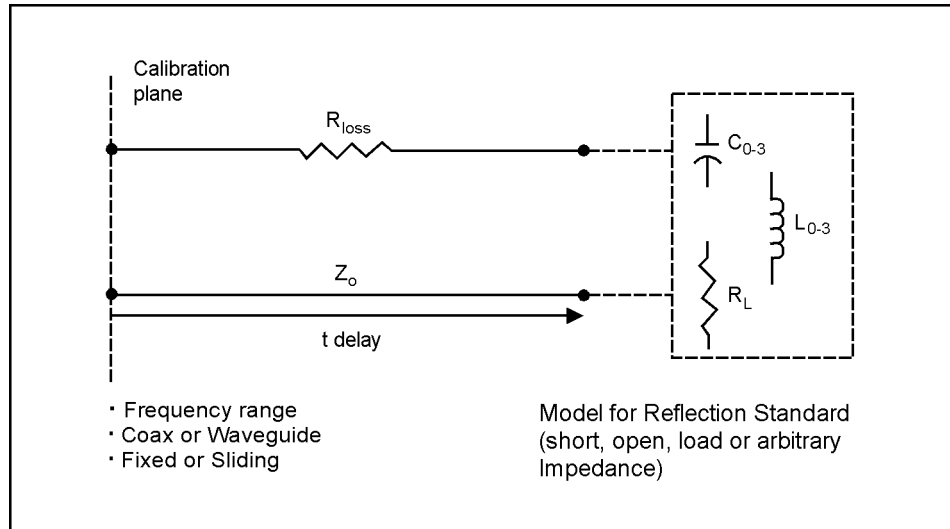

e5070aue004

Figure 4-56

Transmission Standard Model (THRU)

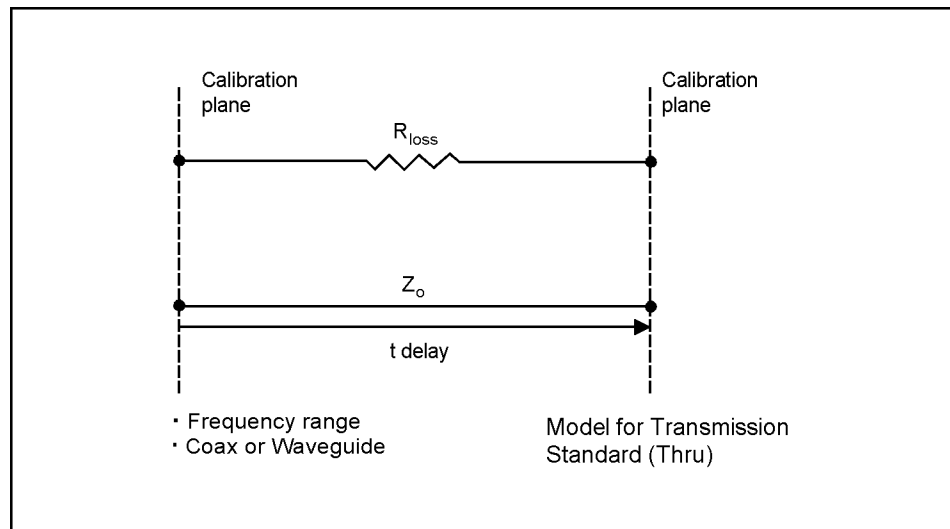

e5070aue005

Z₀

The offset impedance between the standard to be defined and the actual measurement plane. Normally, this is set to the system's characteristic impedance.

Delay

The delay that occurs depending on the length of the transmission line between the standard to be defined and the actual measurement plane. In an OPEN, SHORT, or LOAD standard, the delay is defined as one-way propagation time (sec.) from the measurement plane to the standard. In a THRU standard, it is defined as one-way propagation time (sec.) from one measurement plane to the other. The delay can be

Calibration

Changing the Calibration Kit Definition

determined through measurement or by dividing the exact physical length of the standard by the velocity coefficient.

Loss This is used to determine the energy loss caused by the skin effect along the length (one-way) of the coaxial cable. Loss is defined using the unit of Ω/s at 1 GHz. In many applications, using the value 0 for the loss should not result in significant error. The loss of a standard is determined by measuring the delay (sec.) and the loss at 1 GHz and then substituting them in the formula below.

$$Loss\left(\frac{\Omega}{s}\right) = \frac{loss(dB) \times Z_0(\Omega)}{4.3429(dB) \times delay(s)}$$

C0, C1, C2, C3 It is extremely rare for an OPEN standard to have perfect reflection characteristics at high frequencies. This is because the fringe capacitance of the standard causes a phase shift that varies along with the frequency. For internal calculation of the analyzer, an OPEN capacitance model is used. This model is described as a function of frequency, which is a polynomial of the third degree. Coefficients in the polynomial may be defined by the user. The formula for the capacitance model is shown below.

$$C = (C0) + (C1 \times F) + (C2 \times F^2) + (C3 \times F^3)$$

F: measurement frequency

C0 unit: (Farads) (constant in the polynomial)

C1 unit: (Farads/Hz)

C2 unit: (Farads/Hz²)

C3 unit: (Farads/Hz³)

L0, L1, L2, L3 It is extremely rare for a SHORT standard to have perfect reflection characteristics at high frequencies. This is because the residual inductance of the standard causes a phase shift that varies along with the frequency. It is not possible to eliminate this effect. For internal calculation of the analyzer, a short-circuit inductance model is used. This model is described as a function of frequency, which is a polynomial of the third degree. Coefficients in the polynomial may be defined by the user. The formula for the inductance model is shown below.

$$L = (L0) + (L1 \times F) + (L2 \times F^2) + (L3 \times F^3)$$

F: Measurement frequency

L0 unit: [Farads] (the constant in the polynomial)

L1 unit: [Farads/Hz]

L2 unit: [Farads/Hz²]

L3 unit: [Farads/Hz³]

In most existing calibration kits, THRU standards are defined as “zero-length THRU,” i.e., the delay and loss are both “0”. Such a THRU standard does not exist, however. Calibration must be done with two test ports interconnected directly.

NOTE

The measurement accuracy depends on the conformity of the calibration standard to its definition. If the calibration standard has been damaged or worn out, the accuracy will decrease.

Redefining a calibration kit

To change the definition of a calibration kit, follow the procedure below.

Defining a new calibration kit

1. Select the calibration kit to be redefined.
2. Define the type of standard. Select one from among the OPEN, SHORT, LOAD, delay/THRU, and arbitrary impedance standards.
3. Define the standard coefficient.
4. Designate a standard class for the standard.
5. Save the data for the calibration kit that has been redefined.

Changing the pre-defined connector between male and female (e.g. OPNE (f) to OPEN (m))

1. Select the calibration kit to be redefined.
2. Designate a standard class for the standard.
3. Save the data for the calibration kit that has been redefined.

Redefining a calibration kit

Step 1. Press Cal.

Step 2. Press **Cal Kit**.

Step 3. Select the calibration kit to be redefined according to the list below.

Softkey	Function
85033E	Selects the “85033E” calibration kit
85033D	Selects the “85033D” calibration kit
85052D	Selects the “85052D” calibration kit
85032F	Selects the “85032F” calibration kit
85032B	Selects the “85032B” calibration kit
85036B/E	Selects the “85036B/E” calibration kit
85031B	Selects the “85031B” calibration kit
85050C/D	Selects the “85050C/D” calibration kit
85052C	Selects the “85052C” calibration kit
85038A/F/M	Selects the “85038A/F/M” calibration kit
User	Selects the fourth user-defined calibration kit

NOTE

If the names (labels) of calibration kits were changed prior to operation, the new names will appear on the respective softkeys.

Calibration

Changing the Calibration Kit Definition

Step 4. Press **Modify Kit**. To change the pre-defined connector type (e.g. OPEN(f) to OPEN (m)) skip to Step 14.

Step 5. Press **Define STDs**.

Step 6. Select the standard to be redefined from among standards numbered 1 through 21.

Step 7. Press **STD Type**.

Step 8. Select the type of standard according to the list below.

Softkey	Function
Open	Selects the OPEN standard
Short	Selects the SHORT standard
Load	Selects the LOAD standard
Delay/Thru	Selects the delay/THRU standard
Arbitrary	Selects the arbitrary impedance
None	Selects no standard type

Step 9. Set the standard coefficient according to the list below.

Softkey	Function
C0	Sets C0
C1	Sets C1
C2	Sets C2
C3	Sets C3
L0	Sets L0
L1	Sets L1
L2	Sets L2
L3	Sets L3
Offset Delay	Sets the offset delay
Offset Z0	Sets the offset Z0 ^{*1}
Offset Loss	Sets the offset loss
Arb. Impedance	Sets an arbitrary impedance
Min. Frequency	Sets a start frequency. ^{*2}
Max. Frequency	Sets a stop frequency. ^{*2}
Connector Type	Selects a media type.

^{*1.} Specify 1 Ω when Waveguide is set for the media type.

^{*2.} Specify cutoff frequency when Waveguide is set for the media type.

- Step 10.** Press **Label** and input a new label for the standard using the keypad displayed on the screen.
- Step 11.** Press **Return**.
- Step 12.** Repeat Step 6 to Step 11 to redefine all standards for which changes are necessary.
- Step 13.** Press **Return**.
- Step 14.** Press **Specify CLSs**.
- Step 15.** Select the class to be redefined according to the list below.

Softkey	Function
Sub Class	Selects a subclass you want to use.
Open	Selects the OPEN class
Short	Selects the SHORT class
Load	Selects the LOAD class
Thru	Selects the THRU class
TRL Reflect	Selects TRL Reflect.
TRL Line/Match	Selects TRL Line/Match.

- Step 16.** For TRL Thru, select ports.

Softkey	Function
Port 1-2	Selects port 1 and port 2.
Port 1-3	Selects port 1 and port 3.
Port 1-4	Selects port 1 and port 4.
Port 2-3	Selects port 2 and port 3.
Port 2-4	Selects port 2 and port 4.
Port 3-4	Selects port 3 and port 4.

NOTE Select **Set All** to use the same standards for all test ports.

- Step 17.** Select the test port according to the list below.

Softkey	Function
Port 1	Selects port 1
Port 2	Selects port 2
Port 3	Selects port 3
Port 4	Selects port 4

Calibration

Changing the Calibration Kit Definition

NOTE Select **Set All** to use the same standards for all test ports.

- Step 18.** Select the standards to be registered in the class from among standards numbered 1 through 21. To change the connectors between male and female (e.g. OPEN (f) to OPEN (m)), select the appropriately labeled standards here.
- Step 19.** Repeat Step 17 and Step 18 until classes are defined for all test ports that need to be redefined.
- Step 20.** Press **Return**.
- Step 21.** Repeat Step 15 to Step 20 to redefine all classes that need to be modified.
- Step 22.** Press **Return**.
- Step 23.** Press **Label Kit** and input a new label for the calibration kit by using the keypad displayed on the screen.

Example of defining the TRL calibration kit

You need to enter the definition of the TRL calibration kit to perform TRL calibration. Follow these steps to define the following calibration kit given as an example.

- THRU (Delay 0 ps, Offset Loss 1.3 Gohm/s)
- REFLECT(SHORT, Delay 0 ps)
- MATCH (@0 to 2GHz)
- LINE1 (50-ohm transmission line, Delay 54.0 ps @ 2G to 7GHz)
- LINE2 (50-ohm transmission line, Delay 13.0 ps @ 7G to 32GHz)

Procedure to define the name of the calibration kit

- Step 1.** Press .
- Step 2.** Press **Cal Kit**.
- Step 3.** Select a User kit that has not been registered.
- Step 4.** Press **Modify Kit**.
- Step 5.** Press **Label Kit [User]**.
- Step 6.** Type in a name you want.

Procedure to define Thru and Reflect

- Step 1.** Press **Define STDs**.
- Step 2.** Press **1:No Name - Label**.
- Step 3.** Type in **THRU**.
- Step 4.** Select **STD Type - Delay/Thru**.
- Step 5.** Set **Offset Loss** to 1.3Gohm/s, and **Offset Delay** to 0.
- Step 6.** Press **Return** to return to the Define STD menu.

Step 7. In the same way, repeat Step 2 to Step 6 to enter the definition of REFLECT to No. 2. Select SHORT for STD Type.

Procedure to define Match

Step 1. Press **3:No Name - Label**.

Step 2. Type in **MATCH <2G**.

Step 3. Press **STD Type - Load**.

Step 4. Set **Max Frequency** to 2GHz.

Step 5. Press **Return** to return to the Define Std menu.

Procedure to define Line 1/2

Step 1. Press **4:No Name - Label**.

Step 2. Type in **LINE <7G**.

Step 3. Press **STD Type - Thru**.

Step 4. Set **Offset Delay** to 54ps.

Step 5. Set **Min Frequency** to 2GHz.

Step 6. Set **Max Frequency** to 7GHz.

Step 7. Press **Return** to return to the Define Std menu.

Step 8. Press **5:No Name - Label**.

Step 9. Type in **LINE >7G**.

Step 10. Press **STD Type - Thru**.

Step 11. Set **Offset Delay** to 13ps.

Step 12. Set **Min Frequency** to 7GHz.

Step 13. Press **Return** to return to the Define Std menu.

Step 14. Press **Return** to return to the Modify Cal Kit menu.

Procedure to register Thru/Reflect/Match to sub class 1

Step 1. Press **Specify CLSs - Sub Class**.

Step 2. Select **Sub Class1**.

Step 3. Press **TRL Thru - Set All - THRU - Return**.

Step 4. Press **TRL Reflect - REFLECT**.

Step 5. Press **TRL Line/Match - Set All - MATCH <2G - Return**.

Procedure to register Line 1/2 to subclass 2/3

Step 1. Select **Sub Class2**.

Step 2. Press **TRL Line/Match - Set All - LINE <7G - Return**.

Calibration

Changing the Calibration Kit Definition

Step 3. Select **Sub Class3** .

Step 4. Press **TRL Line/Match - Set All - LINE >7G - Return**.

Step 5. Press and check that the name you specified is selected as Cal Kit.

By assigning Match and Line 1/2 to subclass 1/2/3 respectively, you can calibrate 3 standards with different frequency bands for TRL line/match calibration.

Setting options for TRL calibration

This section describes how to set the reference impedance and measurement data of the standard used for calculating the calibration plane for TRL calibration.

Step 1. Press .

Step 2. Press **Cal Kit**, and select a calibration kit.

Step 3. Press **Modify Cal Kit**.

Step 4. Press **TRL Option**.

Step 5. Press **Impedance** to select the reference impedance.

Softkey	Function
Line	Calculates the calibration coefficient using the characteristic impedance of the line standard as the reference impedance. The impedance of the line standard is used as the center of the Smith chart, and the calibration coefficient is calculated using the line standard's as the direction.
System	Calculates the calibration coefficient using the system impedance as the reference impedance. Select this when the line impedance and the test port impedance differ.

Step 6. Press **Reference Plane** to select the measurement data of the standard used for calculating the reference plane.

Softkey	Function
Thru	Uses the length of the thru/line standard to calculate the calibration plane.
Reflect	Uses the reflection coefficient of the reflection standard to calculate the calibration plane.

Setting a media type for the calibration kit

You can set a media type for the standard you use.

Setting procedure

- Step 1.** Press **Cal**.
- Step 2.** Press **Cal Kit**, and select a calibration kit.
- Step 3.** Press **Modify Cal Kit**.
- Step 4.** Press **Define STDs**, and select a standard.
- Step 5.** Press **Media**, and select a media type.

Softkey	Function
Coaxial	Selects coaxial as the media type.
Waveguide	Selects waveguide as the media type.

NOTE If you select waveguide as the media type, set the system impedance and the characteristic impedance to 1 Ω .

NOTE Depending on the media type you use, the calculation method of the electrical delay, which is required to correct the phase delay, differs. For more information, see “Electrical Delay” on page 398.

Saving and loading definition file of calibration kit

You can save the definition file of the calibration kit for each standard into a file on a storage device (hard disk drive or floppy disk drive), then recall it later to reproduce the definition.

Save procedure

- Step 1.** Press .
- Step 2.** Press **Cal Kit**, and select a calibration kit you want to save.
- Step 3.** Press **Modify Cal Kit**.
- Step 4.** Press **Export Cal Kit...** to open the dialog box.
- Step 5.** Specify a folder, enter a file name, and press **Save**.

NOTE The file is saved with the (.ckx) extension. Do not open and modify it directly.

NOTE Never modify the contents (folders and files) of drives except for drive A: (floppy disk drive) and drive D:. Modifying the contents of drives other than drive A: and drive D: may give serious damage to the functions and performance of the E5070B/E5071B.

NOTE When the floppy disk access lamp is lit, do not press the disk ejection button. Ejecting a floppy disk forcefully when the lamp is lit may break the floppy disk or the disk drive.

Call procedure

- Step 1.** Press .
- Step 2.** Press **Cal Kit**, and select a calibration kit you want to save.
- Step 3.** Press **Modify Cal Kit**.
- Step 4.** Press **Import Cal Kit...** to open the dialog box.
- Step 5.** Specify a folder, select a file name, and press **Open**.

NOTE When the floppy disk access lamp is lit, do not press the disk ejection button. Ejecting a floppy disk forcefully when the lamp is lit may break the floppy disk or the disk drive.

Default settings of pre-defined calibration kits

The calibration kits 85033E, 85033D, 85052D, 85032F, 85032B, 85036B/E, 85031B, 85050C/D, and 85052C are pre-defined with their own default settings.

85033E

	1. Short	2. Open	3. Broadband	4. Thru
Label	Short	Open	Broadband	Thru
STD Type	Short	Open	Load	Delay/Thru
C0 [$\times 10^{-15}$ F]	0	49.43	0	0
C1 [$\times 10^{-27}$ F/Hz]	0	-310.13	0	0
C2 [$\times 10^{-36}$ F/Hz ²]	0	23.17	0	0
C3 [$\times 10^{-45}$ F/Hz ³]	0	-0.16	0	0
L0 [$\times 10^{-12}$ H]	2.0765	0	0	0
L1 [$\times 10^{-24}$ H/Hz]	-108.54	0	0	0
L2 [$\times 10^{-33}$ H/Hz ²]	2.1705	0	0	0
L3 [$\times 10^{-42}$ H/Hz ³]	0.01	0	0	0
Offset Delay [s]	31.808 p	29.243 p	0	0
Offset Z0 [Ω]	50	50	50	50
Offset Loss [Ω /s]	2.36 G	2.2 G	2.2 G	2.2 G
Arb. Impedance [Ω]	50	50	50	50

85033D

	1. Short	2. Open	3. Broadband	4. Thru
Label	Short	Open	Broadband	Thru
STD Type	Short	Open	Load	Delay/Thru
C0 [$\times 10^{-15}$ F]	0	49.43	0	0
C1 [$\times 10^{-27}$ F/Hz]	0	-310.13	0	0
C2 [$\times 10^{-36}$ F/Hz ²]	0	23.17	0	0
C3 [$\times 10^{-45}$ F/Hz ³]	0	-0.16	0	0
L0 [$\times 10^{-12}$ H]	2.0765	0	0	0
L1 [$\times 10^{-24}$ H/Hz]	-108.54	0	0	0
L2 [$\times 10^{-33}$ H/Hz ²]	2.1705	0	0	0
L3 [$\times 10^{-42}$ H/Hz ³]	0.01	0	0	0
Offset Delay [s]	31.808 p	29.243 p	0	0
Offset Z0 [Ω]	50	50	50	50
Offset Loss [Ω /s]	2.36 G	2.2 G	2.2 G	2.2 G
Arb. Impedance [Ω]	50	50	50	50

Calibration
Changing the Calibration Kit Definition

85052D

	1. Short	2. Open	5. 3.5/2.92	6. 3.5/SMA	7. 2.92/SMA
Label	Short	Open	3.5/2.92	3.5/SMA	3.5/SMA
STD Type	Short	Open	Open	Open	Open
C0 [$\times 10^{-15}$ F]	0	49.433	6.9558	5.9588	13.4203
C1 [$\times 10^{-27}$ F/Hz]	0	-310.131	-1.0259	-11.195	-1.9452
C2 [$\times 10^{-36}$ F/Hz ²]	0	23.1682	-0.01435	0.5076	0.5459
C3 [$\times 10^{-45}$ F/Hz ³]	0	-0.15966	0.0028	-0.00243	0.01594
L0 [$\times 10^{-12}$ H]	2.0765	0	0	0	0
L1 [$\times 10^{-24}$ H/Hz]	-108.54	0	0	0	0
L2 [$\times 10^{-33}$ H/Hz ²]	2.1705	0	0	0	0
L3 [$\times 10^{-42}$ H/Hz ³]	-0.01	0	0	0	0
Offset Delay [s]	31.785 p	29.243 p	0	0	0
Offset Z0 [Ω]	50	50	50	50	50
Offset Loss [Ω /s]	2.36 G	2.2 G	0	0	0
Arb. Impedance [Ω]	50	50	50	50	50
	8. 2.4/1.85	9. Broadband	11. Thru	13. Adapter	
Label	2.4/1.85	Broadband	Thru	Adapter	
STD Type	Open	Load	Delay/Thru	Delay/Thru	
C0 [$\times 10^{-15}$ F]	8.9843	0	0	0	
C1 [$\times 10^{-27}$ F/Hz]	-13.9923	0	0	0	
C2 [$\times 10^{-36}$ F/Hz ²]	0.3242	0	0	0	
C3 [$\times 10^{-45}$ F/Hz ³]	-0.00112	0	0	0	
L0 [$\times 10^{-12}$ H]	0	0	0	0	
L1 [$\times 10^{-24}$ H/Hz]	0	0	0	0	
L2 [$\times 10^{-33}$ H/Hz ²]	0	0	0	0	
L3 [$\times 10^{-42}$ H/Hz ³]	0	0	0	0	
Offset Delay [s]	0	0	0	94.75 p	
Offset Z0 [Ω]	50	50	50	50	
Offset Loss [Ω /s]	0	0	0	2.51 G	
Arb. Impedance [Ω]	50	50	50	50	

85032F

	1. Short(m)	2. Open(m)	7. Short(f)	8. Open(f)
Label	Short(m)	Open(m)	Short(f)	Open(f)
STD Type	Short	Open	Short	Open
C0 [$\times 10^{-15}$ F]	0	89.939	0	89.939
C1 [$\times 10^{-27}$ F/Hz]	0	2536.8	0	2536.8
C2 [$\times 10^{-36}$ F/Hz ²]	0	-264.99	0	-264.99
C3 [$\times 10^{-45}$ F/Hz ³]	0	13.4	0	13.4
L0 [$\times 10^{-12}$ H]	3.3998	0	3.3998	0
L1 [$\times 10^{-24}$ H/Hz]	-496.4808	0	-496.4808	0
L2 [$\times 10^{-33}$ H/Hz ²]	34.8314	0	34.8314	0
L3 [$\times 10^{-42}$ H/Hz ³]	-0.7847	0	-0.7847	0
Offset Delay [s]	45.955 p	41.19 p	45.955 p	40.8688 p
Offset Z0 [Ω]	49.99	50	49.99	50
Offset Loss [Ω /s]	1.087 G	930 M	1.087 G	930 M
Arb. Impedance [Ω]	50	50	50	50
	9. Broadband	11. Thru	13. (f/f)Adapter	14. (m/m)Adapter
Label	Broadband	Thru	(f/f)Adapter	(m/m)Adapter
STD Type	Load	Delay/Thru	Delay/Thru	Delay/Thru
C0 [$\times 10^{-15}$ F]	0	0	0	0
C1 [$\times 10^{-27}$ F/Hz]	0	0	0	0
C2 [$\times 10^{-36}$ F/Hz ²]	0	0	0	0
C3 [$\times 10^{-45}$ F/Hz ³]	0	0	0	0
L0 [$\times 10^{-12}$ H]	0	0	0	0
L1 [$\times 10^{-24}$ H/Hz]	0	0	0	0
L2 [$\times 10^{-33}$ H/Hz ²]	0	0	0	0
L3 [$\times 10^{-42}$ H/Hz ³]	0	0	0	0
Offset Delay [s]	0	0	339 p	339 p
Offset Z0 [Ω]	50	50	50	50
Offset Loss [Ω /s]	0	0	2.2 G	2.2 G
Arb. Impedance [Ω]	50	50	50	50

NOTE

The designations (m) and (f) in the name (label) of the standard indicate male (m) and female (f) analyzer connectors.

Calibration
Changing the Calibration Kit Definition

85032B

	1. Short(m)	2. Open(m)	3. Broadband	4. Thru
Label	Short(m)	Open(m)	Broadband	Thru
STD Type	Short	Open	Load	Delay/Thru
C0 [$\times 10^{-15}$ F]	0	119.09	0	0
C1 [$\times 10^{-27}$ F/Hz]	0	-36.955	0	0
C2 [$\times 10^{-36}$ F/Hz ²]	0	26.258	0	0
C3 [$\times 10^{-45}$ F/Hz ³]	0	5.5136	0	0
L0 [$\times 10^{-12}$ H]	0	0	0	0
L1 [$\times 10^{-24}$ H/Hz]	0	0	0	0
L2 [$\times 10^{-33}$ H/Hz ²]	0	0	0	0
L3 [$\times 10^{-42}$ H/Hz ³]	0	0	0	0
Offset Delay [s]	93 f	0	0	0
Offset Z0 [Ω]	49.992	50	50	50
Offset Loss [Ω /s]	700 M	700 M	700 M	700 M
Arb. Impedance [Ω]	50	50	50	50
	7. Short(f)	8. Open(f)		
Label	Short(f)	Open(f)		
STD Type	Short	Open		
C0 [$\times 10^{-15}$ F]	0	62.14		
C1 [$\times 10^{-27}$ F/Hz]	0	-143.07		
C2 [$\times 10^{-36}$ F/Hz ²]	0	82.92		
C3 [$\times 10^{-45}$ F/Hz ³]	0	0.76		
L0 [$\times 10^{-12}$ H]	0	0		
L1 [$\times 10^{-24}$ H/Hz]	0	0		
L2 [$\times 10^{-33}$ H/Hz ²]	0	0		
L3 [$\times 10^{-42}$ H/Hz ³]	0	0		
Offset Delay [s]	17.817 p	17.411 p		
Offset Z0 [Ω]	50.209	50		
Offset Loss [Ω /s]	2.1002 G	700 M		
Arb. Impedance [Ω]	50	50		

NOTE

The designations (m) and (f) in the name (label) of the standard indicate male (m) and female (f) analyzer connectors.

85036B/E

	1. Short(m)	2. Open(m)	3. Broadband	4. Thru
Label	Short(m)	Open(m)	Broadband	Thru
STD Type	Short	Open	Load	Delay/Thru
C0 [$\times 10^{-15}$ F]	0	63.5	0	0
C1 [$\times 10^{-27}$ F/Hz]	0	84	0	0
C2 [$\times 10^{-36}$ F/Hz ²]	0	56	0	0
C3 [$\times 10^{-45}$ F/Hz ³]	0	0	0	0
L0 [$\times 10^{-12}$ H]	0	0	0	0
L1 [$\times 10^{-24}$ H/Hz]	0	0	0	0
L2 [$\times 10^{-33}$ H/Hz ²]	0	0	0	0
L3 [$\times 10^{-42}$ H/Hz ³]	0	0	0	0
Offset Delay [s]	0	0	0	0
Offset Z0 [Ω]	75	75	75	75
Offset Loss [Ω /s]	1.13 G	1.13 G	1.13 G	1.13 G
Arb. Impedance [Ω]	50	50	75	50

	7. Short(f)	8. Open(f)
Label	Short(f)	Open(f)
STD Type	Short	Open
C0 [$\times 10^{-15}$ F]	0	41
C1 [$\times 10^{-27}$ F/Hz]	0	40
C2 [$\times 10^{-36}$ F/Hz ²]	0	5
C3 [$\times 10^{-45}$ F/Hz ³]	0	0
L0 [$\times 10^{-12}$ H]	0	0
L1 [$\times 10^{-24}$ H/Hz]	0	0
L2 [$\times 10^{-33}$ H/Hz ²]	0	0
L3 [$\times 10^{-42}$ H/Hz ³]	0	0
Offset Delay [s]	17.544 p	17.544 p
Offset Z0 [Ω]	75	75
Offset Loss [Ω /s]	1.13 G	1.13 G
Arb. Impedance [Ω]	50	50

NOTE

The designations (m) and (f) in the name (label) of the standard indicate male (m) and female (f) analyzer connectors.

Calibration
Changing the Calibration Kit Definition

85031B

	1. Short	2. Open	3. Broadband	4. Thru
Label	Short	Open	Broadband	Thru
STD Type	Short	Open	Load	Delay/Thru
C0 [$\times 10^{-15}$ F]	0	92.85	0	0
C1 [$\times 10^{-27}$ F/Hz]	0	0	0	0
C2 [$\times 10^{-36}$ F/Hz ²]	0	7.2	0	0
C3 [$\times 10^{-45}$ F/Hz ³]	0	4.3	0	0
L0 [$\times 10^{-12}$ H]	0	0	0	0
L1 [$\times 10^{-24}$ H/Hz]	0	0	0	0
L2 [$\times 10^{-33}$ H/Hz ²]	0	0	0	0
L3 [$\times 10^{-42}$ H/Hz ³]	0	0	0	0
Offset Delay [s]	0	0	0	0
Offset Z0 [Ω]	50	50	50	50
Offset Loss [Ω /s]	0.7 G	0.7 G	0.7 G	0.7 G
Arb. Impedance [Ω]	50	50	50	50

85050C/D

	1. Short(m)	2. Open(m)	3. Broadband	4. Thru
Label	Short	Open	Broadband	Thru
STD Type	Short	Open	Load	Delay/Thru
C0 [$\times 10^{-15}$ F]	0	90.48 m	0	0
C1 [$\times 10^{-27}$ F/Hz]	0	763.3 m	0	0
C2 [$\times 10^{-36}$ F/Hz ²]	0	-63.82 m	0	0
C3 [$\times 10^{-45}$ F/Hz ³]	0	6.434 m	0	0
L0 [$\times 10^{-12}$ H]	356.6 m	0	0	0
L1 [$\times 10^{-24}$ H/Hz]	-33.39	0	0	0
L2 [$\times 10^{-33}$ H/Hz ²]	1.754	0	0	0
L3 [$\times 10^{-42}$ H/Hz ³]	-33.60 m	0	0	0
Offset Delay [s]	0	0	0	0
Offset Z0 [Ω]	50	50	50	50
Offset Loss [Ω /s]	0	0	0	0
Arb. Impedance [Ω]	50	50	75	50
	5. 2-18 Line	6. Lowband		
Label	Thru	Lowband		
STD Type	Delay/Thru	Load		
C0 [$\times 10^{-15}$ F]	0	0		
C1 [$\times 10^{-27}$ F/Hz]	0	0		
C2 [$\times 10^{-36}$ F/Hz ²]	0	0		
C3 [$\times 10^{-45}$ F/Hz ³]	0	0		
L0 [$\times 10^{-12}$ H]	0	0		
L1 [$\times 10^{-24}$ H/Hz]	0	0		
L2 [$\times 10^{-33}$ H/Hz ²]	0	0		
L3 [$\times 10^{-42}$ H/Hz ³]	0	0		
Offset Delay [s]	23.190 p	0		
Offset Z0 [Ω]	49.988	50		
Offset Loss [Ω /s]	0.7 G	0		
Arb. Impedance [Ω]	50	50		

NOTE The designation (m) in the name (label) of the standard indicates male analyzer connectors.

Calibration
Changing the Calibration Kit Definition

85052C

	1. Short	2. Open	5. 3.5/2.92	6. 3.5/SMA	7. 2.92/SMA	8. 2.4/1.85
Label	Short	Open	3.5/2.92	3.5/SMA	2.92/SMA	2.4/1.85
STD Type	Short	Open	Open	Open	Open	Open
C0 [$\times 10^{-15}$ F]	0	49.433	6.9558	5.9588	13.4203	8.9843
C1 [$\times 10^{-27}$ F/Hz]	0	-310.131	-1.0259	-11.195	-1.9452	-13.9923
C2 [$\times 10^{-36}$ F/Hz ²]	0	23.1682	-0.01435	0.5076	0.5459	0.3242
C3 [$\times 10^{-45}$ F/Hz ³]	0	-0.15966	0.0028	-0.00243	0.01594	-0.00112
L0 [$\times 10^{-12}$ H]	2.0765	0	0	0	0	0
L1 [$\times 10^{-24}$ H/Hz]	-108.54	0	0	0	0	0
L2 [$\times 10^{-33}$ H/Hz ²]	2.1705	0	0	0	0	0
L3 [$\times 10^{-42}$ H/Hz ³]	-0.01	0	0	0	0	0
Offset Delay [s]	31.785 p	29.243 p	0	0	0	0
Offset Z0 [Ω]	50	50	50	50	50	50
Offset Loss [Ω /s]	2.36 G	2.2 G	0	0	0	0
Arb. Impedance [Ω]	50	50	50	50	50	50
Min Frequency [GHz]	0	0	0	0	0	0
Max Frequency [GHz]	999	999	999	999	999	999
Coax or Waveguide	Coax	Coax	Coax	Coax	Coax	Coax
	9. Broadband	11. Thru	13. Adapter	15. 7-32 line	16. 2-7 line	17. 0-2 loads
Label	Broadband	Thru	Adapter	7-32 line	2-7 line	0-2 line
STD Type	Load	Delay/Thru	Delay/Thru	Delay/Thru	Delay/Thru	Delay/Thru
C0 [$\times 10^{-15}$ F]	0	0	0	0	0	0
C1 [$\times 10^{-27}$ F/Hz]	0	0	0	0	0	0
C2 [$\times 10^{-36}$ F/Hz ²]	0	0	0	0	0	0
C3 [$\times 10^{-45}$ F/Hz ³]	0	0	0	0	0	0
L0 [$\times 10^{-12}$ H]	0	0	0	0	0	0
L1 [$\times 10^{-24}$ H/Hz]	0	0	0	0	0	0
L2 [$\times 10^{-33}$ H/Hz ²]	0	0	0	0	0	0
L3 [$\times 10^{-42}$ H/Hz ³]	0	0	0	0	0	0
Offset Delay [s]	0	0	160.5 p	13.013 p	53.988 p	999 p
Offset Z0 [Ω]	50	50	50	50	50	50
Offset Loss [Ω /s]	0	0	2.51 G	1.3 G	1.3 G	1.3 G
Arb. Impedance [Ω]	50	50	50	50	50	50
Min Frequency [GHz]	0	0	0	6.999	1.000	0
Max Frequency [GHz]	999	999	999	32.001	7.001	2.001
Coax or Waveguide	Coax	Coax	Coax	Coax	Coax	Coax

85038A/F/M

	1. Short	2. Open	3. Broadband	4. Thru
Label	Short	Open	Broadband	Thru
STD Type	Short	Open	Load	Delay/Thru
C0 [$\times 10^{-15}$ F]	0	32.0	0	0
C1 [$\times 10^{-27}$ F/Hz]	0	100	0	0
C2 [$\times 10^{-36}$ F/Hz ²]	0	-50.0	0	0
C3 [$\times 10^{-45}$ F/Hz ³]	0	100	0	0
L0 [$\times 10^{-12}$ H]	0	0	0	0
L1 [$\times 10^{-24}$ H/Hz]	0	0	0	0
L2 [$\times 10^{-33}$ H/Hz ²]	0	0	0	0
L3 [$\times 10^{-42}$ H/Hz ³]	0	0	0	0
Offset Delay [s]	66.734 p	66.734 p	0	0
Offset Z0 [Ω]	50	50	50	50
Offset Loss [Ω/s]	0.63 G	0.63 G	0	0
Arb. Impedance [Ω]	50	50	50	50

Specifying Different Standard for Each Frequency

Defining different standard for each frequency band

This section demonstrates the procedure to define a different open standard for each frequency band, based on the following information.

Table 4-6 Example of standard definition

Standard	Label name	Frequencies to be defined
Open	Open 3G	1 GHz - 3 GHz
Open	Open 6G	3 GHz - 6 GHz

Procedure

- Step 1.** Press .
- Step 2.** Press **Cal Kit**.
- Step 3.** Select a calibration kit you want to define.
- Step 4.** Press **Modify Kit**.
- Step 5.** Press **Define STDs**.
- Step 6.** Select #1, press **Label**, and enter **Open 3G** using the character input pad that appears on the screen.
- Step 7.** Select **Open** as the standard type (**STD Type**).
- Step 8.** Set a necessary standard coefficient.
- Step 9.** Enter **1G** as the minimum frequency for **Min Frequency**.
- Step 10.** Enter **3G** as the maximum frequency for **Max Frequency**.
- Step 11.** Press **Return**.
- Step 12.** In the same way, select #2, press **Label**, and enter **Open 6G** using the character input pad that appears on the screen.
- Step 13.** Select **Open** as the standard type (**STD Type**).
- Step 14.** Set a necessary standard coefficient.
- Step 15.** Enter **3G** as the minimum frequency for **Min Frequency**.
- Step 16.** Enter **6G** as the maximum frequency for **Max Frequency**.
- Step 17.** Press **Return**.

Defining standard for each subclass

This section demonstrates the procedure to specify a different OPEN standard for each frequency band, using subclasses #1 and #2. In this example, the standards created in “Defining different standard for each frequency band” on page 202 are used.

Procedure

- Step 1.** Press .
- Step 2.** Press **Cal Kit**.
- Step 3.** Select a calibration kit you want to use. (In this example, use the calibration kit defined in Step 3 of “Defining different standard for each frequency band” on page 202.)
- Step 4.** Press **Modify Kit**.
- Step 5.** Press **Specify CLSs**.
- Step 6.** Press **Sub Class**, and select **Sub Class 1**.
- Step 7.** Select the standard type **Open**, press **Set All**, make settings for all ports.
- Step 8.** Select #1 (**Open 3G**).
- Step 9.** Press **Return**.
- Step 10.** Then, press **Sub Class**, and select **Sub Class 2**.
- Step 11.** Select the standard type **Open**, press **Set All**, make settings for all ports.
- Step 12.** Select #2 (**Open 6G**).
- Step 13.** Press **Return**.

Disabling standard defined for a subclass

The following procedure shows how to disable a standard defined for a subclass. Note that you cannot disable subclass 1 because at least one standard must exist. The following procedure shows how to disable an OPEN standard of subclass 2.

Procedure

- Step 1.** Press .
- Step 2.** Press **Cal Kit**.
- Step 3.** Select a calibration kit you want to use. (In this example, use the calibration kit defined in Step 3 of “Defining different standard for each frequency band” on page 202.)
- Step 4.** Press **Modify Kit**.
- Step 5.** Press **Specify CLSs**.
- Step 6.** Press **Sub Class**, and select **Sub Class 2**.
- Step 7.** Select the standard type **Open**, press **Set All**, make settings for all ports.
- Step 8.** Select **None**.
- Step 9.** Press **Return**.

Notes on how frequency ranges are dealt when using subclasses

By using several subclasses, you can set a different standard for each frequency, but note the following on frequency ranges. The following table shows possible cases and whether calibration is possible.

Table 4-7 Possible cases of frequency ranges and whether calibration is possible

Possible cases of frequency ranges	Execution of calibration
Example 4-1, “When frequency ranges specified with subclasses overlap,”	Possible
Example 4-2, “When frequency ranges specified with subclasses do not cover a part of a measurement frequency range,”	Impossible
Example 4-3, “When a frequency range specified with a subclass lies outside the measurement frequency range,”	Possible
Example 4-4, “When a part of a frequency range specified with a subclass lies outside the measurement frequency range,”	Possible

Example 4-1 When frequency ranges specified with subclasses overlap

For the measurement frequency range (1 GHz - 8 GHz), if you execute calibration with a standard of subclass 1 (1 GHz-5 GHz) and then with a standard of subclass 2 (4 GHz-8 GHz), the standard last executed is applied for the overlapping portion (4 GHz-5 GHz).

Figure 4-57 When frequency ranges overlap

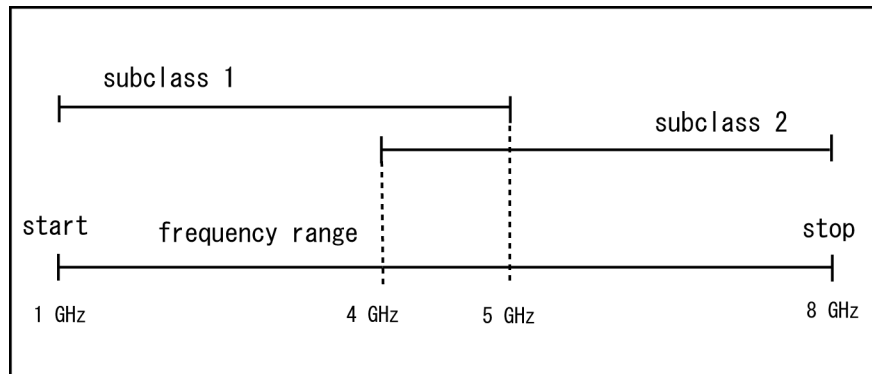

e5070bue8013

Calibration
Specifying Different Standard for Each Frequency

Example 4-2

When frequency ranges specified with subclasses do not cover a part of a measurement frequency range

For a measurement frequency range (1 GHz - 8 GHz), if you execute calibration with a standard of subclass 1 (1 GHz-5 GHz) and then with a standard of subclass 2 (6 GHz-8 GHz), **Done** is not available for the undefined portion (5 GHz-6 GHz).

Figure 4-58

When a part of a frequency range is not covered

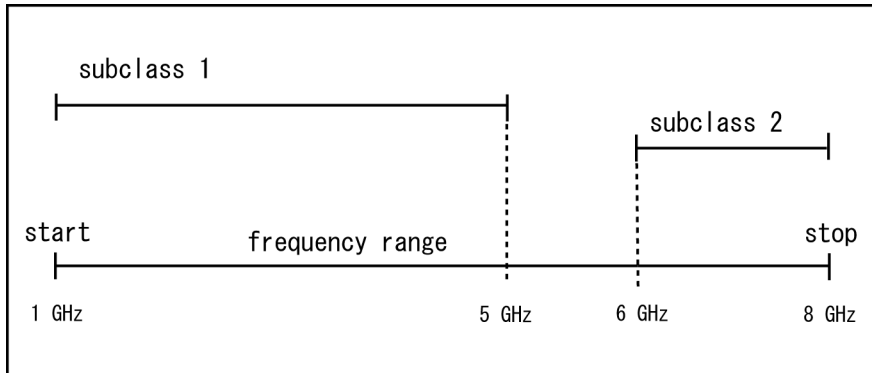

e5070bu j8011

Example 4-3

When a frequency range specified with a subclass lies outside the measurement frequency range

For a measurement frequency range (1 GHz - 5 GHz), if you define a standard of subclass 1 (1 GHz - 5 GHz) and a standard of subclass 2 (5 GHz-8 GHz), calibration possible for subclass 2 although it is out of the measurement frequency range. The calibration coefficients, however, are disregarded. (There is no check mark on the softkey.) Note that, because the standard of subclass 1 covers the measurement frequency range, **Done** is available.

Figure 4-59

When a subclass is out of a frequency range

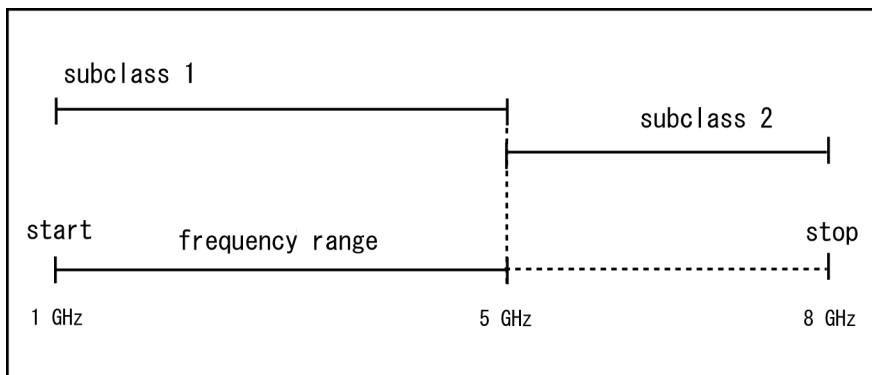

e5070bue8010

Example 4-4 When a part of a frequency range specified with a subclass lies outside the measurement frequency range

For a measurement frequency range (1 GHz - 6 GHz), if you define a standard of subclass 1 (1 GHz - 5 GHz) and a standard of subclass 2 (5 GHz-8 GHz), a part of subclass 2 (6 GHz-8 GHz) lies outside the measurement frequency range, but the other part (5 GHz-6 GHz) lies within it, so calibration is possible.

Figure 4-60 When a part of a frequency range lies outside the range

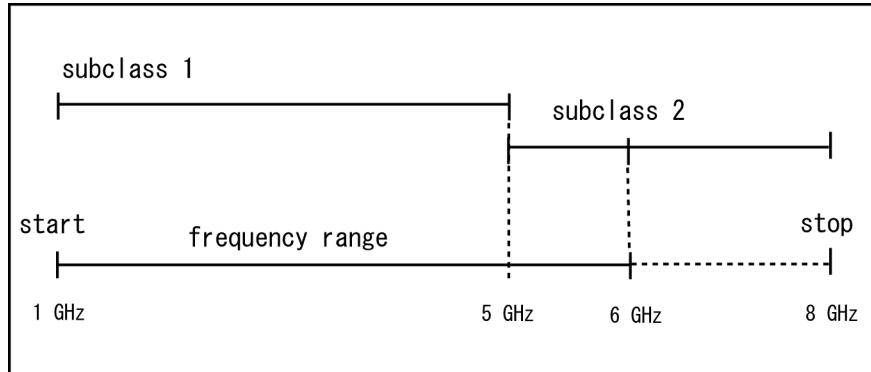

e5070bue8012

Power Calibration

The E5070B/E5071B has a calibration feature for power level output that uses the a power meter (power calibration).

The power calibration function outputs a stimulus signal with a more accurate power level (closer to the set value) by measuring calibration data (power level) in advance with the power meter and sensor. Then this function performs error correction of the power level by using the calibration data.

Turning ON or OFF power level error correction

Power calibration data are acquired for each channel/test port, and you can turn ON/OFF the power level error correction independently for any channel or test port.

The status of the power level error correction of each channel is indicated by one of the symbols shown in Table 4-8 in the channel status bar in the lower part of the window.

Table 4-8

Power Calibration Status

Symbol	Status of power level error correction
PC (displayed in blue)	Error correction is performed for all stimulus ports
PC (displayed in gray)	Error correction is performed for some stimulus ports
PC? (displayed in blue)	Error correction is performed for all stimulus ports; interpolated calibration data *1 is used
PC? (displayed in gray)	Error correction is performed for some stimulus ports; interpolated calibration data *1 is used
---	Error correction is not performed (some stimulus ports have error correction set to on, but there is no valid calibration data)
None	Error correction is not performed (error correction is off for all stimulus ports)

*1. If you turn on the error correction function when the stimulus setting is different from that when the power calibration data were acquired, power level error correction is performed with interpolated calibration data only when calibration data can be interpolated (extrapolation is not performed for calibration data).

Procedure to turn ON/OFF power level error correction

Power level error correction is automatically turned on when you execute the measurement of calibration data. You can turn it on or off as necessary by using the following procedure.

- Step 1. Press .
- Step 2. Press **Power Calibration**.
- Step 3. Select a port (see “Selecting target port of error correction”).
- Step 4. Press **Correction**. Each press toggles this selection between ON/OFF.

Preparing power meter and sensor

To execute power calibration, you need to prepare the power meter and power sensor used to acquire power calibration data. Table 4-9 shows available power meters and recommended power sensors for power calibration.

Table 4-9 Available power meters and recommended power sensors

	Model name
Power meters	Agilent 437B
	Agilent 438A
	Agilent E4416A
	Agilent E4417A
	Agilent E4418A
	Agilent E4418B
	Agilent E4419A
	Agilent E4419B
	Agilent N1911A
	Agilent N1912A
	HP EPM-441A
	HP EPM-442A
	Power sensors
Agilent E4412A	
HP ECP-E18A	

Calibration

Power Calibration

Preparing to control the power meter

When acquiring power calibration data, the power meter is controlled via GPIB from the E5070B/E5071B.

To control the power meter from the E5070B/E5071B, connect the USB port of the E5070B/E5071B and the GPIB connector of the power meter through the USB/GPIB interface as shown in Figure 4-61 and set the GPIB address of the connected power meter with the E5070B/E5071B.

NOTE

The USB/GPIB interface must be ready to use. For more information, see “Setting the GPIB” on page 426.

Setting GPIB address of the power meter

Use the following procedure to set the GPIB address of the power meter:

- Step 1.** Press **System**.
- Step 2.** Press **Misc Setup**.
- Step 3.** Press **GPIB Setup**.
- Step 4.** Press **Power Meter Address**.
- Step 5.** Enter the GPIB address of the power meter you are using.

Figure 4-61 Connection between power meter and E5070B/E5071B

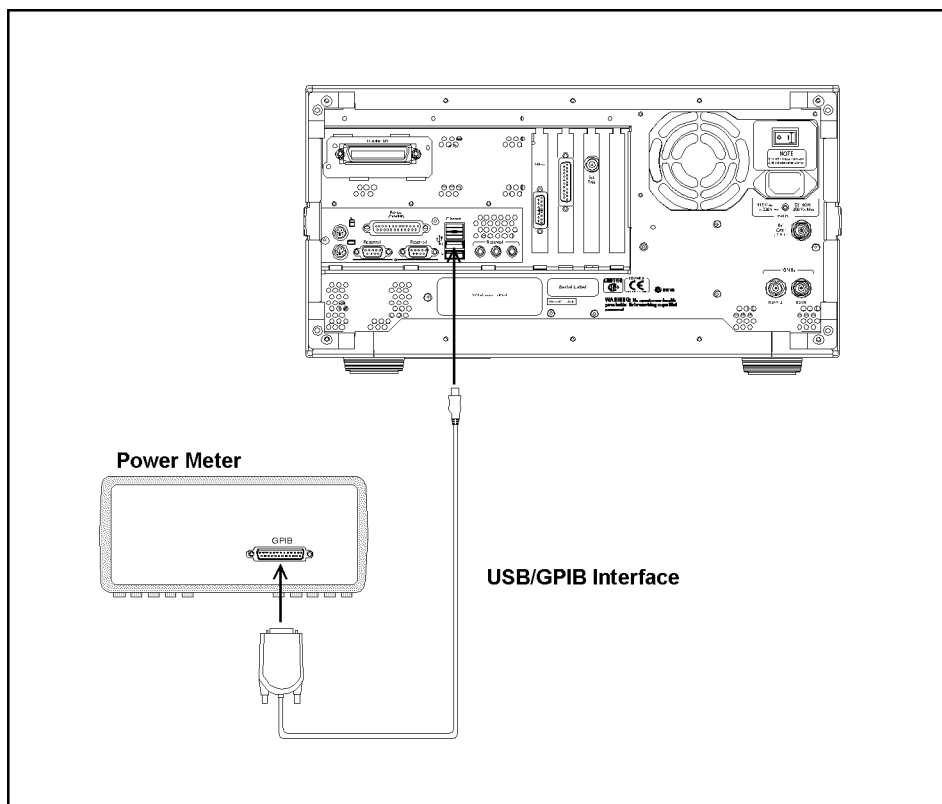

Setting power sensor calibration factor table

NOTE Before using the power sensor calibration factor table of the E5070B/E5071B, set the calibration factor to 100% and then calibrate the power sensor.

When you use the 437B or 438A as the power meter, you need to set the power sensor calibration factor table with the E5070B/E5071B.

If you use a power meter other than the 437B or 438A, refer to the following table.

Power sensor	Setting of calibration factor table
8482A	Set the calibration factor table with the E5070B/E5071B only when you do not set the calibration factor table with the power meter. If you set the calibration factor table with both the power meter and the E5070B/E5071B, calibration is executed by both of them and you cannot obtain correct measurement results.
E4412A ECP-E18A	You do not need to set the calibration factor table with the E5070B/E5071B. Even if you set the calibration factor table with the E5070B/E5071B, this setting would be ignored.

NOTE If you use the E4418A, E4419A, EPM-441A, or EPM-442A with firmware version Ax.02.00 or earlier and you set the calibration factor table with the E5070B/E5071B, calibration is executed by both the power meter and the E5070B/E5071B due to this firmware version, and thus you cannot obtain correct measurement results. Therefore, never set the calibration factor table under this condition with the E5070B/E5071B.

Use the following procedure to set the power sensor's calibration factor table:

- Step 1.** Press .
- Step 2.** Press **Power Calibration**.
- Step 3.** Press **Sensor A Settings** (for power sensor connected to channel A) or **Sensor B Settings** (for power sensor connected to channel B).
- Step 4.** Press **Ref Cal Factor**.
- Step 5.** Enter the reference calibration factor (the calibration factor at 50 MHz).
- Step 6.** According to the calibration factor data attached to the power sensor, set the frequency (**Frequency**) and the coefficient (**Factor**) of the calibration factor table by using the following hardkeys and softkeys.















NOTE Pressing - **OK** does not affect the current setting of the reference calibration factor and the calibration factor table.

NOTE For a frequency other than one set in the table, a value obtained by linear interpolation of the calibration factors at the 2 points adjacent to the frequency is used. If a frequency is lower than the lowest frequency in the table, the calibration factor at the lowest frequency is used; if larger than the highest frequency in the table, the calibration factor at the highest

Calibration

Power Calibration

frequency is used.

Hardkey	Function
	If you select a cell and then press this key, you enter the mode that allows you to edit the cell character by character. If you change a value and then press this key, the value is entered in the cell.
 	Moves up or down in the cell selected in the table. In the character-by-character edit mode, you can select an item or perform a stepped change of data.
 	Moves right or left in the cell selected in the table.
   ...   	Enters a value in the cell.
   	
Softkey	Function
Delete	Deletes the line in which the selected cell is included.
Add	Adds a new line above the line in which the selected cell is included.
Clear Cal Factor Table - OK	Resets the table.

NOTE

When setting the table by using the front panel keys or the keyboard, you need to first set the focus on (select) the operation target (table or softkey). You can change the focus by pressing  in the ENTRY block. When the focus is placed on the table, the window frame of the table is displayed as bright as the window frame of the active channel. When the focus is placed on the softkey menu, the softkey menu title area is displayed in blue.

Figure 4-62

Example of creating power sensor calibration factor table

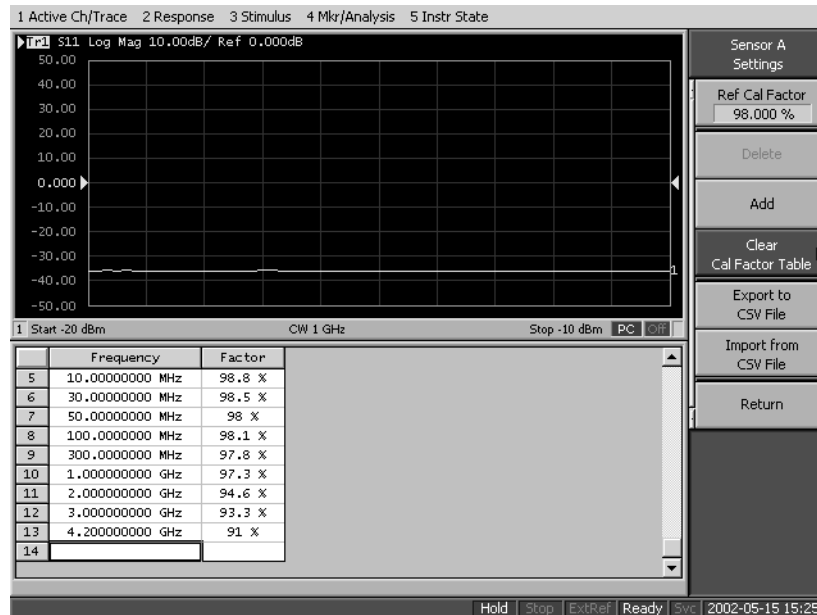

Saving power sensor calibration factor table

You can save the power sensor calibration factor table as a CSV (Comma Separated Value) format file.

- Step 1. Press **Cal**.
- Step 2. Press **Power Calibration**.
- Step 3. Press **Sensor A Settings** or **Sensor B Settings**.
- Step 4. Press **Export to CSV File** to open the Save As dialog box. For information on the Save As dialog box, see the description in Figure 10-9, “Printers window,” on page 370. At this time, CSV File (extension*.csv) is selected as the file type.
- Step 5. Enter a file name in the **File Name** box and press the **Save** button to save the power sensor calibration factor table.

Recalling power sensor calibration factor table

By recalling a power sensor calibration factor table saved in the CSV format according to “Saving power sensor calibration factor table” on page 213, you can set the power sensor calibration factor table.

- Step 1. Press **Cal**.
- Step 2. Press **Power Calibration**.
- Step 3. Press **Sensor A Settings** or **Sensor B Settings**.
- Step 4. Press **Import from CSV File** to open the Open dialog box. For information on the Open dialog box, see the description in Figure 10-10, “File menu in Printers window,” on page 371. At this time, CSV File (extension*.csv) is selected as the file type.

Calibration
Power Calibration

Step 5. Select the CSV format file you want to import and press the **Open** button to recall the power sensor calibration factor table.

NOTE

This operation is not guaranteed under the following two conditions: 1) you imported a CSV format file created/edited on a spreadsheet program, or 2) you imported a CSV format file that had been exported according to “Saving power sensor calibration factor table” on page 213 but then modified.

Selecting target port of error correction

The power level error correction is executed for each channel/test port. You can set the following items for each channel/test port:

- ON/OFF of error correction
- Setting of loss compensation
- Selection of the power sensor
- Number of power level measurements at one measurement point
- Calibration data

Follow the steps below to select the test port for which you want to set/execute power level error correction.

- Step 1.** Press **Cal**.
- Step 2.** Press **Power Calibration**.
- Step 3.** Press **Channel Next** or **Channel Prev** to select the channel.
- Step 4.** Press **Select Port**.
- Step 5.** Press the softkey corresponding to the test port you want to select.

Setting loss compensation

If you need to apply a signal with a more accurate power level to the DUT, you can use the loss compensation feature to obtain calibration data for correcting the difference in power loss due to the difference in connection method (cable, adapter, etc.) between the time when the power calibration data are measured and when the actual DUT is measured.

The loss compensation feature corrects the power measurement result based on the preset power loss data. More specifically, if you turn on the loss compensation, the measurement result of the power level obtained in the power calibration data measurement is a value obtained by adding the loss value set in the loss compensation table to the measured power value.

Turning ON/OFF loss compensation

Follow these steps to turn ON/OFF the loss compensation.

- Step 1.** Press **Cal**.
- Step 2.** Press **Power Calibration**.
- Step 3.** Select a port (see “Selecting target port of error correction” on page 215).
- Step 4.** Press **Loss Compn**.
- Step 5.** Press **Compensation**. Each press toggles the selection between ON/OFF.

Calibration

Power Calibration















Creating loss compensation table

Follow these steps to set the loss compensation table.

- Step 1.** Press .
- Step 2.** Press **Power Calibration**.
- Step 3.** Select a port (see “Selecting target port of error correction” on page 215).
- Step 4.** Press **Loss Compen**.
- Step 5.** Set the frequency (**Frequency**) and the loss (**Loss**) of the loss compensation table by using the following hardkeys and softkeys.

NOTE Pressing  - **OK** does not affect the current setting of the loss compensation table.

NOTE For a frequency other than one set in the table, a value obtained by linear interpolation of the losses at the 2 points adjacent to the frequency is used. If a frequency is lower than the lowest frequency in the table, the loss at the lowest frequency is used; if larger than the highest frequency in the table, the loss at the highest frequency is used.

Hardkey	Function
	If you select a cell and then press this key, you enter the mode that allows you to edit the cell character by character. If you change a value and then press this key, the value is entered in the cell.
 	Moves up or down in the cell selected in the table. In the character-by-character edit mode, you can select an item or perform a stepped change of data.
 	Moves right or left in the cell selected in the table.
   ...   	Enters a value in the cell.
   	
Softkey	Function
Delete	Deletes the line in which the selected cell is included.
Add	Adds a new line above the line in which the selected cell is included.
Clear Loss Table - OK	Resets the table.

NOTE When setting the table by using the front panel keys or the keyboard, you need to first set focus on (select) the operation target (table or softkey). You can change the focus by pressing  in the ENTRY block. When the focus is placed on the table, the window frame of the table is displayed as bright as the window frame of the active channel. When the focus is placed on the softkey menu, the softkey menu title area is displayed in blue.

Saving loss compensation table

You can save the loss compensation table as a CSV (Comma Separated Value) format file.

- Step 1.** Press .
- Step 2.** Press **Power Calibration**.
- Step 3.** Select a port (see “Selecting target port of error correction” on page 215).
- Step 4.** Press **Loss Compen**.
- Step 5.** Press **Export to CSV File** to open the Save As dialog box. For information on the Save As dialog box, see the description in Figure 10-9, “Printers window,” on page 370. At this time, CSV File (extension*.csv) is selected as the file type.
- Step 6.** Enter a file name in the **File Name** box and press the **Save** button to save the loss compensation table.

Recalling loss compensation table

By recalling a loss compensation table saved in the CSV format according to the “Saving loss compensation table” on page 217, you can set this loss compensation table.

NOTE

It is possible to recall a file from a different channel/port from where it was saved.

- Step 1.** Press .
- Step 2.** Press **Power Calibration**.
- Step 3.** Select a port (see “Selecting target port of error correction” on page 215).
- Step 4.** Press **Loss Compen**.
- Step 5.** Press **Import from CSV File** to open the Open dialog box. For information on the Open dialog box, see the description in Figure 10-10, “File menu in Printers window,” on page 371. At this time, CSV File (extension*.csv) is selected as the file type.
- Step 6.** Select the CSV format file you want to import and press the **Open** button to recall the loss compensation table.

NOTE

This operation is not guaranteed under the following two conditions: 1) you imported a CSV format file created/edited on a spreadsheet program, or 2) you imported a CSV format file that had been exported according to “Saving loss compensation table” on page 217 but then modified.

Setting a tolerance for power calibration

When a tolerance is set, an error message is displayed and the power calibration is aborted if the averaged measured power value during the power calibration goes outside the specified tolerance.

If the power calibration is aborted, the power-level error-correction function is not turned on.

This function notifies you of failed power calibration, which normally takes a long time if an error occurs in the measurement results, by displaying an error without having to wait for the end of the power calibration.

Setting the tolerance

Follow these steps to set the tolerance for power calibration.

- Step 1.** Press .
- Step 2.** Press **Power Calibration**.
- Step 3.** Press **Tolerance**.
- Step 4.** Enter the tolerance value for power calibration.

Measuring calibration data

NOTE

Before measuring calibration data, you need to execute the zero adjustment and calibration of the power sensor. For information on how to execute these operations, see the manual of the power meter you are using.

When using the power sensor calibration factor table of the E5070B/E5071B, set the calibration factor to 100% and execute the calibration of the power sensor.

- Step 1.** Press .
- Step 2.** Press **Power Calibration**.
- Step 3.** Select a port (see “Selecting target port of error correction” on page 215).
- Step 4.** Press **Use Sensor**. Each press toggles between channel A and channel B. If you use a power meter with one channel, channel A is always selected.
- Step 5.** Press **Num of Readings**.
- Step 6.** Enter the number of power level measurements at one measurement point (averaging factor).
- Step 7.** Connect the power sensor for the selected channel to the selected port as shown in the figure below.

Figure 4-63 Connection of power sensor

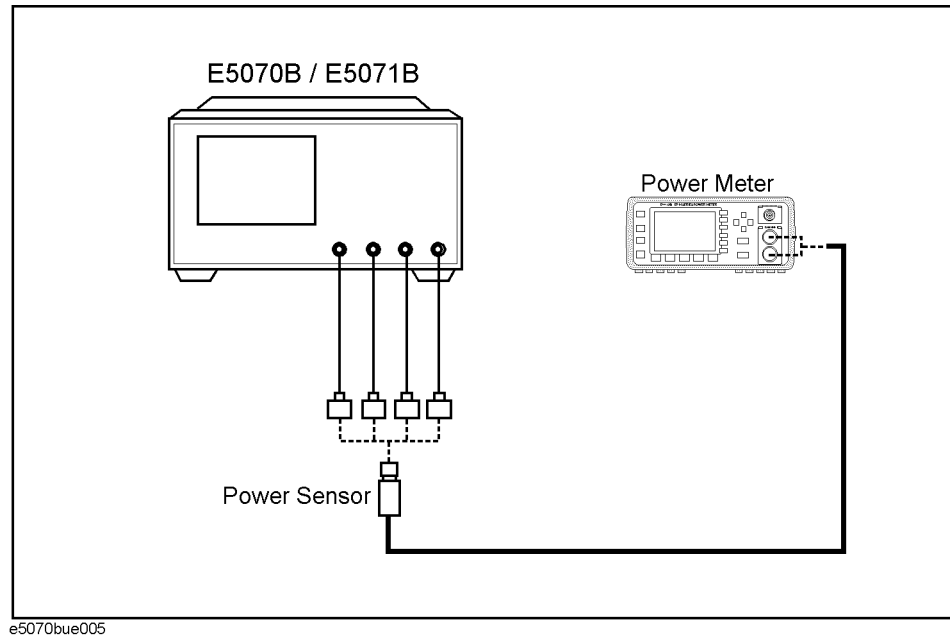

Step 8. Press **Take Cal Sweep** to start the measurement of calibration data.

NOTE If the power meter GPIB address is not set correctly or if the power sensor is not connected to the specified channel, an error occurs and calibration data are not measured.

You can abort the measurement by pressing **Abort** during measurement.

When the measurement is complete, the power level error correction is automatically turned on.

NOTE If appropriate calibration data cannot be obtained, an error may occur for each sweep after the measurement of calibration data is complete. In this event, turn off the power level error correction, check the connection and setting, and then measure the calibration data again.

Receiver Calibration

The E5070B/E5071B has a function to calibrate the gain of the individual receivers in absolute value measurement.

The receiver calibration function calibrates the gain of the receiver by inputting the output power of a stimulus port that has been assigned a correct value by the power calibration to the port of the receiver you need to calibrate.

NOTE Receiver calibration is valid only for the parameters of absolute value measurement.

Turning ON/OFF receiver error correction

The receiver calibration data are acquired for each channel/test port, so the error correction of the power level can be turned ON/OFF independently for any channel or port.

The status of the power level error correction for each channel is indicated by one of the symbols in the channel status bar in the lower part of the window, as shown in Table 4-10.

Table 4-10

Receiver Calibration Status

Symbol	Status of receiver error correction
RC (displayed in blue)	Error correction is performed for all of the receiver ports.
RC (displayed in grey)	Error correction is performed for some of the receiver ports.
RC? (displayed in blue)	Error correction is performed for all of the receiver ports. Interpolated calibration data is used.
RC? (displayed in grey)	Error correction is performed for some of the receiver ports. Interpolated calibration data is used.
RC! (displayed in blue)	Error correction is performed for all of the receiver ports. Extrapolated calibration data is used.
RC! (displayed in grey)	Error correction is performed for some of the receiver ports. Extrapolated calibration data is used.
---	Error correction is not performed. (At least one receiver port is turned on for error correction, but valid calibration data are not available.)
None	Error correction is not performed. (Error correction is turned off for all of the receiver ports.)

Turning receiver error correction ON/OFF

The error correction of the receiver is automatically turned on when the calibration data are measured. You can also turn this ON/OFF explicitly by following the steps below.

Step 1. Press .

Step 2. Press **Receiver Calibration**.

- Step 3.** Select a port (see “Selecting target port for error correction”).
- Step 4.** Press **Correction**. Each time the key is pressed, ON and OFF switches over alternately.

Selecting target port for error correction

The error correction of receiver ports is performed for each channel/port, and you can set the following items for them:

- Turning on or off error correction
- Calibration data

- Step 1.** Press .
- Step 2.** Press **Receiver Calibration**.
- Step 3.** Press or to select a channel.
- Step 4.** Press **Select Port**.
- Step 5.** Press the softkey corresponding to the port you want to calibrate.

Measuring the calibration data

NOTE

The power calibration information on both the receiver port and source port is used to calculate calibration coefficients. The accuracy of receiver calibration will increase if power calibration is implemented for both the receiver port and the source port before starting receiver calibration. For information on power calibration, refer to “Power Calibration” on page 208.

- Step 1.** Press .
- Step 2.** Press **Receiver Calibration**.
- Step 3.** Select a port (see “Selecting target port for error correction” on page 221).
- Step 4.** Press **Source Port**.
- Step 5.** Select the stimulus port for which you want to perform power calibration.
- Step 6.** Refer to Figure 4-64 to connect the selected stimulus port by cable to any port you want to calibrate.

Figure 4-64

Example of connection between output port and receiver port

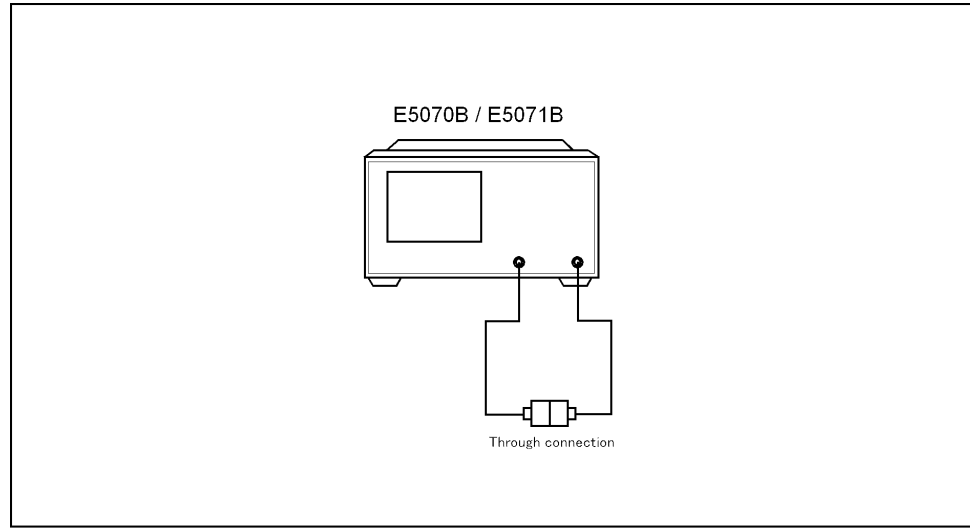

Step 7. Press **Take Cal Sweep** to start measurement of calibration data. This step allows the gain of the receiver to be calibrated, turning on the error correction function automatically.

Vector-Mixer Calibration

The E5070B/E5071B has a vector-mixer calibration function for use in measuring frequency conversion devices.

The vector-mixer calibration allows you to measure the magnitude, phase and group delay of the mixer's conversion loss by using in combination calibration standards (OPEN/SHORT/LOAD) and calibration mixer with an IF filter, as well as the network de-embedding function incorporated in the E5070B/E5071B.

You can also perform balanced mixer measurements by using two calibration mixers that each has an IF filter.

NOTE

Note that the vector-mixer calibration is only available for swept IF measurement, not for fixed IF or fixed RF measurement.

Overview of vector-mixer calibration

Figure 4-65 shows an outline of vector-mixer calibration.

Vector-mixer calibration is implemented by eliminating the characteristics of the calibration mixer and IF filter by using the network de-embedding function after full 2-port calibration has been completed. As shown in Figure 4-65, using the up/down conversion method allows you to specify the same sweep measurement frequency for the input and output ports, thus enabling full 2-port calibration at the end of the target port. Consequently, only the characteristics of the measured mixer (DUT) can be obtained by using the network de-embedding function, after eliminating the characteristics of the calibration mixer with an IF filter from all measurement results.

NOTE

Since the up/down conversion method is used in vector-mixer calibration, the frequency-offset function is not used.

Figure 4-65

Overview of vector-mixer calibration

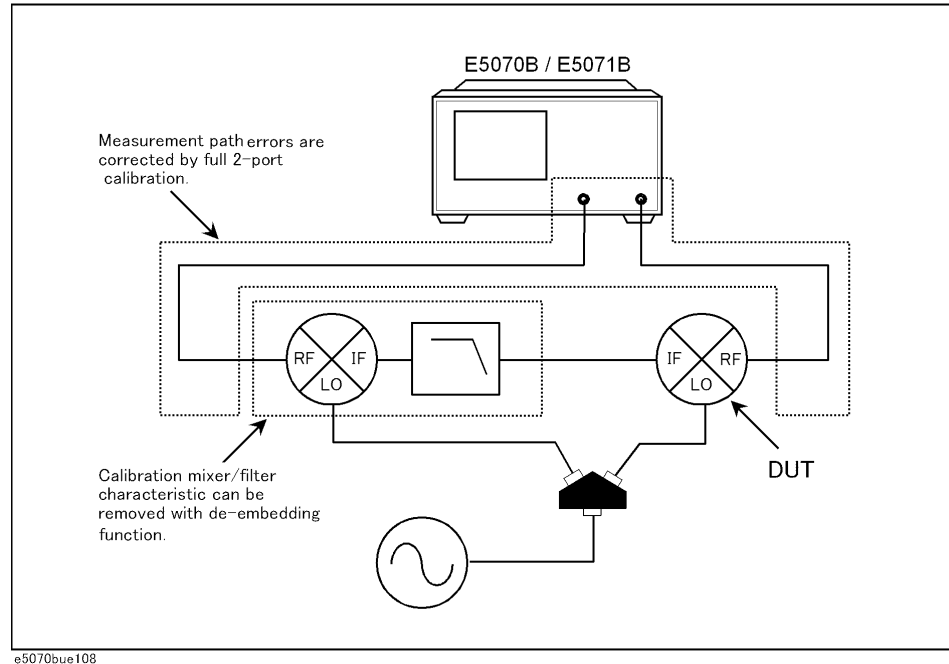

As shown in Figure 4-65, the vector-mixer calibration requires the characteristics data for the calibration mixer with IF filter.

Measured mixer

A measured mixer (DUT) signifies an unknown target mixer of measurement. However, a measured mixer meeting the requirements for a calibration mixer can be used as a calibration mixer.

Calibration mixer (with IF filter)

The calibration mixer is required for supporting the measurement system of the up/down conversion. You must also evaluate in advance the frequency response characteristics of the calibration mixer. The vector-mixer calibration method obtains the characteristics of the measured mixer alone by using the network de-embedding function to eliminate the characteristics of the calibration mixer from the measurement result. You can use the IF filter to select any required frequency conversion component such as RF+LO, RF-LO, and LO-RF. The calibration mixer and IF filter can be seen as a part of the test system setup, just like the network analyzer and the test cable; they are connected at the same location during the entire calibration or measurement.

NOTE

The frequency range must be equal to or greater than that of the measured mixer. If you want to test multiple mixers with a single setup, select a wide range of calibration mixers that can cover all frequencies of the target test devices.

Characterizing calibration mixer (with IF filter)

In vector-mixer calibration, you must characterize the calibration mixer with the IF filter. As shown in Figure 4-66, connect the target mixer (with IF filter) to the port of the network

analyzer on which vector calibration has been performed and then connect an OPEN, SHORT or LOAD standard to the end of the IF filter to start reflection measurement. The signals measured at the test port include the reflection signal from the mixer’s RF port, the IF signal (IF+) converted by the mixer and then reflected by the IF filter, and the IF signal (IF-) passing through the IF filter and then reflected by the calibration standard.

The characteristics of the calibration mixer can be described in a 1-port error model, and each error item can be determined from Γ_O , Γ_S , and Γ_L , which are obtained in the reflection measurement of individual standards.

Figure 4-66 Characteristics evaluation of calibration mixer (with IF filter)

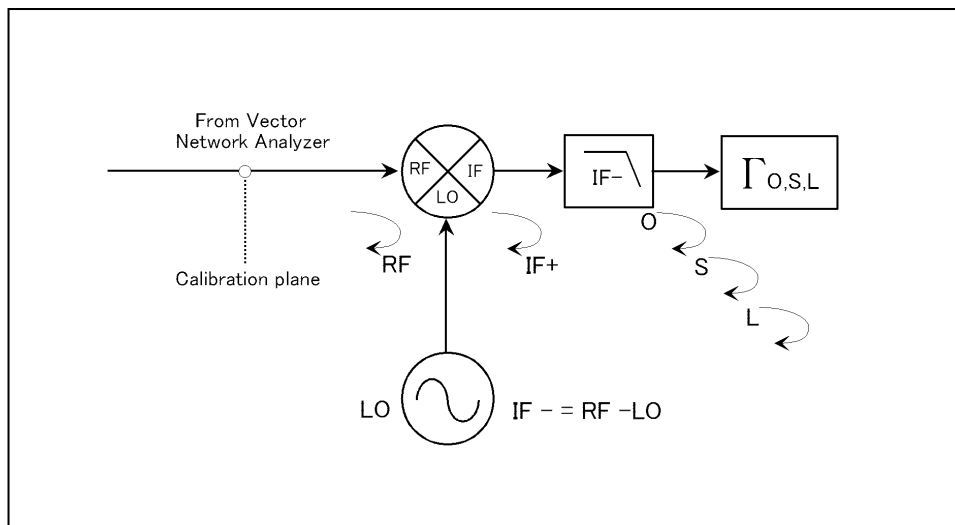

e5070bue107

NOTE The calibration mixer must be reciprocal. The term “reciprocal” means the magnitude and phase of the conversion loss are equal both in the forward and reverse directions. The forward conversion loss occurs during the measurement of the output signal at the IF port while inputting measurement signals into the RF port. In contrast, the reverse conversion loss occurs during measurement of the output signal at the RF port while inputting measurement signals into the IF port.

NOTE For precise calibration, the conversion loss in each direction must be less than 10 dB using a calibration mixer and IF filter in combination. Exceeding 15 dB of the conversion loss in any direction may deteriorate the calibration accuracy significantly.

Characterizing procedure for calibration mixer (with IF filter)

The E5070B/E5071B has a pre-installed VBA macro (Vector Mixer Characterization) for characterizing the calibration mixer with an IF filter.

Storage Folder	VBA Macro (Project Name)
D:\Agilent	MixerCharacterization.vba

How to execute characterization of calibration mixer

1. Setting Stimulus Conditions

Set the stimulus conditions for the channel you want to calibrate. For the necessary steps, refer to “Setting Stimulus Conditions” on page 70.

You must also set the external signal source in advance. For the necessary steps, refer to “2. Setting External Signal Source” on page 316.

2. Running VBA Macro

NOTE

Full 2-port calibration is recommended for characterizing the calibration mixer with the IF filter, although 1-port calibration is also available. This is because using full 2-port calibration simplifies the evaluation procedures, which are described in “Overview of vector-mixer calibration” on page 223. For detailed information on full 2-port calibration, see “Full 2-Port Calibration” on page 118.

Load the VBA project and then run it.

- Step 1.** Press **Macro Setup**.
- Step 2.** Press **Load & Project**.
- Step 3.** Specify “D:\Agilent\MixerCharacterization.vba” for the file name in the Open dialog box and then press the **Open** button.
- Step 4.** Press **Macro Run** to run the macro (see Figure 4-67).

Figure 4-67 Vector Mixer Characterization Macro

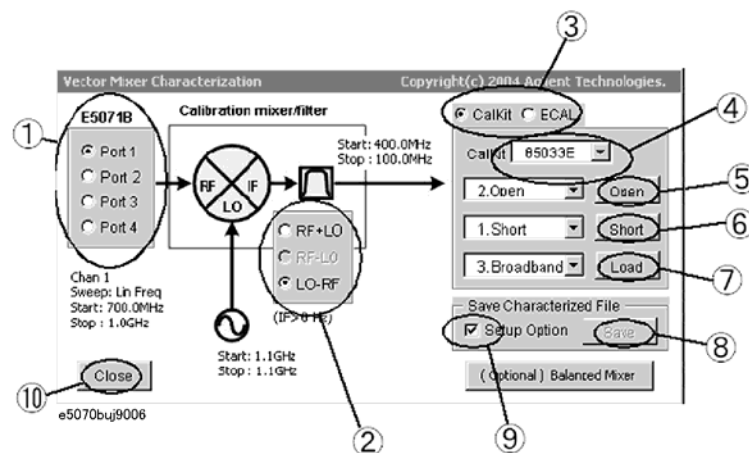

3. Selecting Measurement Port

Select the 1-port calibration port (1 in Figure 4-67).

NOTE

Select any port if full 2-port calibration is set.

4. Setting IF Frequency

Select IF frequency from RF+LO, RF-LO and LO-RF (2 in Figure 4-67), depending on the IF frequency of the calibration mixer.

NOTE

The number displayed in the Vector Mixer Characterization macro is the frequency set in the E5070B/E5071B and read from it. You must also set the minimum IF frequency at more than 0 kHz.

IF BW must be set to much smaller value than IF frequency.

5. Selecting a Calibration Kit

Select a calibration kit (3 in Figure 4-67).

NOTE

The mechanical calibration kit displayed in the Vector Mixer Characterization macro is the frequency registered in the E5070B/E5071B and read from it. If an ECal module is connected to the E5070B/E5071B, ECal will be selected automatically.

6. Measuring Calibration Mixer with IF Filter (when using calibration kit)

Connect the calibration mixer to one of the test ports on which 1-port calibration has been done, as shown in Figure 4-68.

Figure 4-68

Connection of calibration mixer (with IF filter)

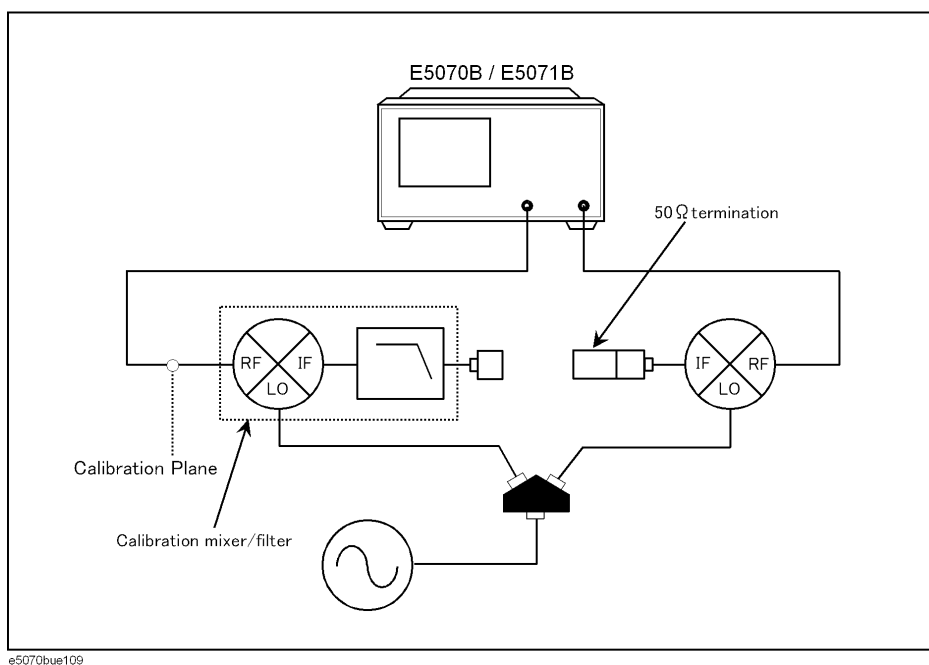

NOTE

Select any port if full 2-port calibration is set.

NOTE

As shown in Figure 4-68, we recommend that you characterize the calibration mixer with an IF filter when the power splitter for distributing the LO signal is connected to the

Calibration

Vector-Mixer Calibration

measured mixer. In vector-mixer calibration, where the up/down conversion method is used, the power of the LO signal is distributed to the calibration mixer and the measured mixer through the power splitter. During a characteristics evaluation of the calibration mixer, the LO power level used by the drive of the calibration mixer must be equal to the LO power level with the measured mixer connected. This is because the mixer's conversion loss and reflection coefficient are significantly affected by the power level of the LO signal.

- Step 1.** Select **CalKit** (3 in Figure 4-67).
- Step 2.** Select the type number of the calibration kit from **CalKit** menu (3 in Figure 4-67).
- Step 3.** Press the **Open** button (5 in Figure 4-67) to start measurement in OPEN.
- Step 4.** Press the **Short** button (6 in Figure 4-67) to start measurement in SHORT.
- Step 5.** Press the **Load** button (7 in Figure 4-67) to start measurement in LOAD.

7. Measuring Calibration Mixer with IF Filter (when using ECal module)

Figure 4-69 Characterizing calibration mixer using ECal

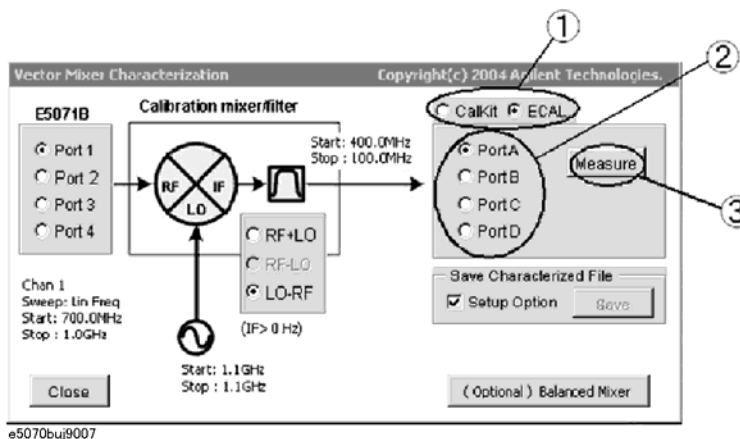

- Step 6.** Select **ECal** (1 in Figure 4-69).
- Step 7.** Select the port used for the ECal module (2 in Figure 4-69).
- Step 8.** Press the **Measure** button (3 in Figure 4-69) to start measurement.

8. Saving Characteristic Data and Closing VBA Macro

- Step 1.** Press the Save button (8 in Figure 4-67) to open the Save screen (Figure 4-70).
- Step 2.** Press the Save button (1 in Figure 4-70) to specify a name for the characteristic data of the calibration mixer with IF filter. Then save it to a Touchstone file.

Figure 4-70 Saving characteristic data of calibration mixer (with IF filter)

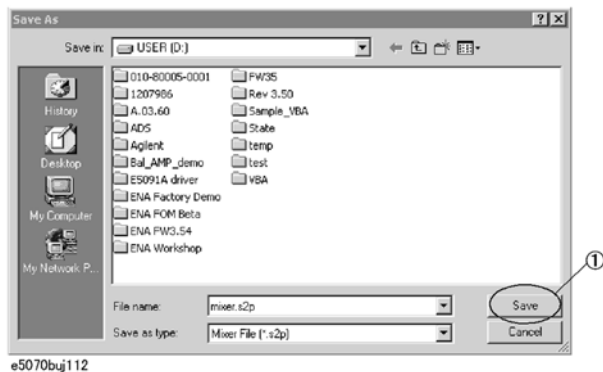

NOTE If you check the Setup Option (9 in Figure 4-67), the saved characteristic data will be set for the specified port of the active channel as the characteristic data file of the network de-embedding, and the fixture simulator function will be enabled. If unchecked, only the characteristic data will be saved.

Step 3. Press the **Close** button (10 in Figure 4-67) to exit the macro.

Characterizing calibration mixer (with IF filter) for balance mixer measurement

The VBA macro (Vector Mixer Characterization) provided with the E5070B/E5071B allows you to characterize the calibration mixer (with IF filter) to be used for the balanced mixer measurement. The characterizing procedures of the calibration mixer with IF filter used for balance mixer measurement are basically the same as those used for normal mixer measurement; however, two characteristic data of the calibration mixer with IF filter are required for balanced mixer measurement, as shown in Figure 4-71.

Connect the target calibration mixer (with IF filter) to the port of the network analyzer on which calibration has been performed and then connect the OPEN, SHORT and LOAD standards to the end of the IF filter to start reflection measurement and characterization. For a balanced mixers, the phase difference of the LO signals between the calibration mixers with IF filter will remain as an error, since each calibration mixer with IF filter is characterized independently. Therefore, you must calibrate the phase difference between the two characterized calibration mixers with IF filters.

Figure 4-71 Characteristics evaluation of calibration mixer (with IF filter) for balance mixer

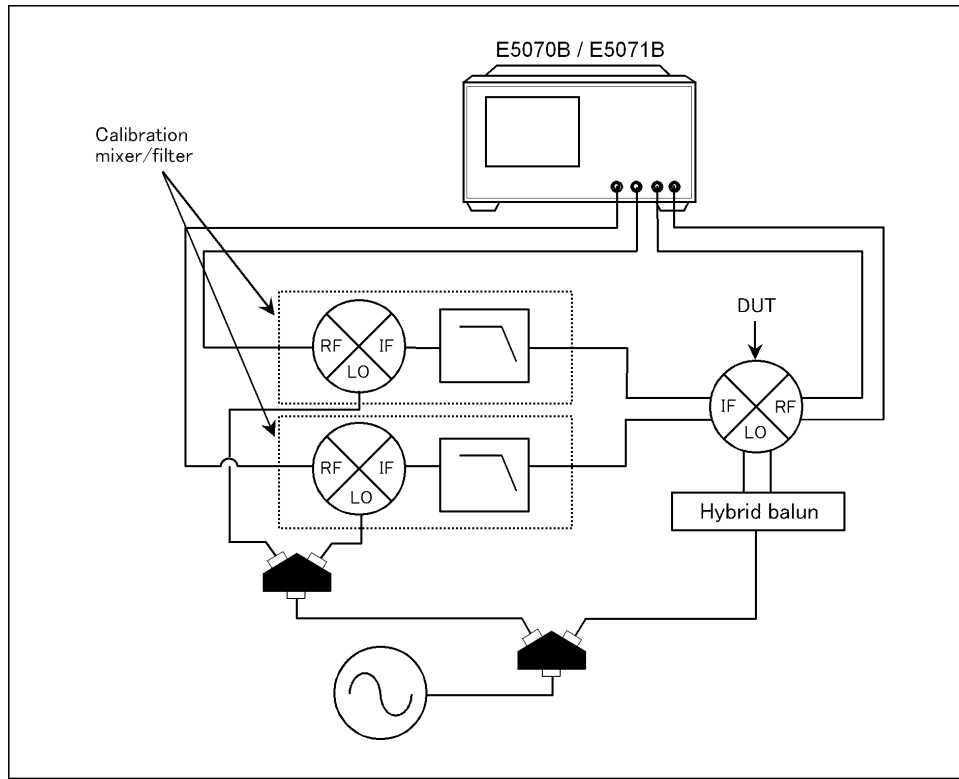

e5070bue116

How to execute characterization

1. Characterizing Calibration Mixer (with IF filter)

Measure the characteristic data of each calibration mixer with the IF filter used for balanced mixer measurement, using any two ports.

Set the stimulus conditions for the channel you want to calibrate. For the necessary steps, refer to “Setting Stimulus Conditions” on page 70.

You must also set the external signal source in advance. For the necessary steps, refer to “2. Setting External Signal Source” on page 316.

NOTE If you characterize a calibration mixer with an IF filter, we recommend that you perform full 4-port calibration in advance, since it simplifies the evaluation procedures. For detailed information on full 4-port calibration, see “Full 4-Port Calibration” on page 124.

- Step 1.** Press **Macro Setup**.
- Step 2.** Press **Load & Project**.
- Step 3.** Specify “D:\Agilent\MixerCharacterization.vba” for the file name in the Open dialog box and then press the **Open** button.
- Step 4.** Press **Macro Run** to run the macro (see Figure 4-72).
- Step 5.** Select **Port 1** (1 in Figure 4-72) to characterize the calibration mixer 1 with IF filter. In this case, the data are saved to a temporary file (MIXER_1.s2p).

NOTE For detailed information on characterizing the calibration mixer, see “Characterizing procedure for calibration mixer (with IF filter)” on page 225.

- Step 6.** Select **Port 2** (1 in Figure 4-72) to characterize calibration mixer 2 with IF filter. Here, the data are also saved to a temporary file (MIXER_2.s2p).

NOTE For detailed information on characterizing the calibration mixer, see “Characterizing procedure for calibration mixer (with IF filter)” on page 225.

- Step 7.** Press **(Optional) Balanced Mixer** (2 in Figure 4-72).

Figure 4-72 Vector Mixer Characterization Macro

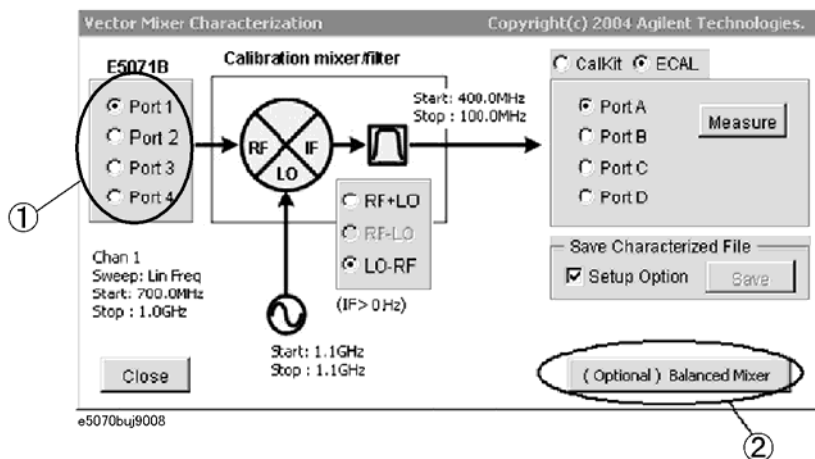

- Step 8.** As the Vector Mixer Characterization Macro is running, the data files of the pre-measured calibration mixer with IF filter (MIXER_1.s2p, MIXER_2.s2p) are read automatically into

Calibration Vector-Mixer Calibration

the macro (1 in Figure 4-73).

NOTE

If failure occurs when reading the data file for the calibration mixer with IF filter, the characterization may have done by using only one port instead of using two ports.

Figure 4-73 Balanced Mixer Characterization Macro

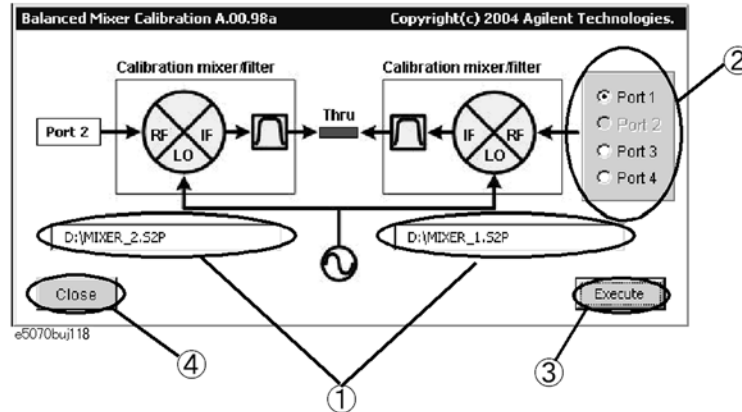

Step 9. Select the measurement port as shown in Figure 4-73 (2 in Figure 4-73) and then connect a THRU between the IF ports of the calibration mixers to correct the phase difference of the LO signals for the calibration mixers with IF filters.

Step 10. Pressing the **Execute** (3 in Figure 4-73) button executes a phase error correction and overwrites the results on the original data file.

NOTE

You cannot run the **Execute** function when selecting the measurement port if the data file of the calibration mixer with IF filter (*.s2p) has not been set for the network removal function of the fixture simulator.

NOTE

The phase error correction data reflects the phase difference of the LO signals for the phase information of the calibration mixer's data file, which is registered in any two ports.

Step 11. Press the **Close** button (4 in Figure 4-73) to exit macro.

Scalar-Mixer Calibration

The E5070B/E5071B has a scalar-mixer calibration function for measuring frequency conversion devices.

Scalar-mixer calibration allows you to measure the magnitude value and reflection parameter of the mixer's conversion loss with very high accuracy by performing calibration using calibration standards (OPEN/SHORT/LOAD) in combination as well as a power meter.

For measurement of the conversion loss in a frequency conversion device, normal full 2-port calibration is not available because of the frequency difference between the stimulus port and the response port. Therefore, scalar-mixer calibration allows you to correct the error term that resides in a full 2-port error model by using the error model and an expression based on a new concept.

You can correct the following error elements by using the scalar-mixer calibration.

- The reflection between the output port of the network analyzer and the input port of the measured mixer (vector error correction).
- The reflection between the output port of the measured mixer and the input port of the network analyzer (vector error correction).
- Transmission frequency characteristics at different frequencies (scalar error correction).

The frequency-offset error model can be described by the flow graph in Figure 4-74. From the flow graph it can be seen that the model is divided in two halves: the stimulus port and the response port. By conceptualizing the error model in these two halves, each error term can be isolated to either of the model's halves depending on the frequency at which it was generated. The majority of the signals will only affect measurements by causing errors at the same frequency. Two error signals that are functions of both halves of the frequency-offset model are isolation (EXF) and transmission tracking (ETF). EXF is set to zero because it cannot be detected by the frequency change. ETF must be divided into two types of errors: one associated with the stimulus side at the input frequencies and the other associated with the response side at the output frequencies. As previously discussed, calculating the transmission tracking (ETF) based on both stimulus and response sides is the key to using error correction during frequency-offset measurements.

In scalar-mixer calibration, use the power meter to measure the transmission tracking error (ESTF) of the signal source in both the output and input frequencies in order to calculate the transmission tracking in the frequency-offset (ETF). The transmission tracking of the receiver in the output frequency (ERTF) can be determined by dividing the transmission tracking (ETF) calculated based on the output frequency in full 2-port calibration by the receiver's transmission tracking (ESTF). Multiplying the signal source transmission tracking (ESTF) by the receiver transmission tracking (ERTF) provides the transmission tracking in the frequency-offset (ETF). Since ESTF and ERTF are products of two power measurements, the resulting correction coefficient is a scalar parameter.

Figure 4-74

frequency-offset error model

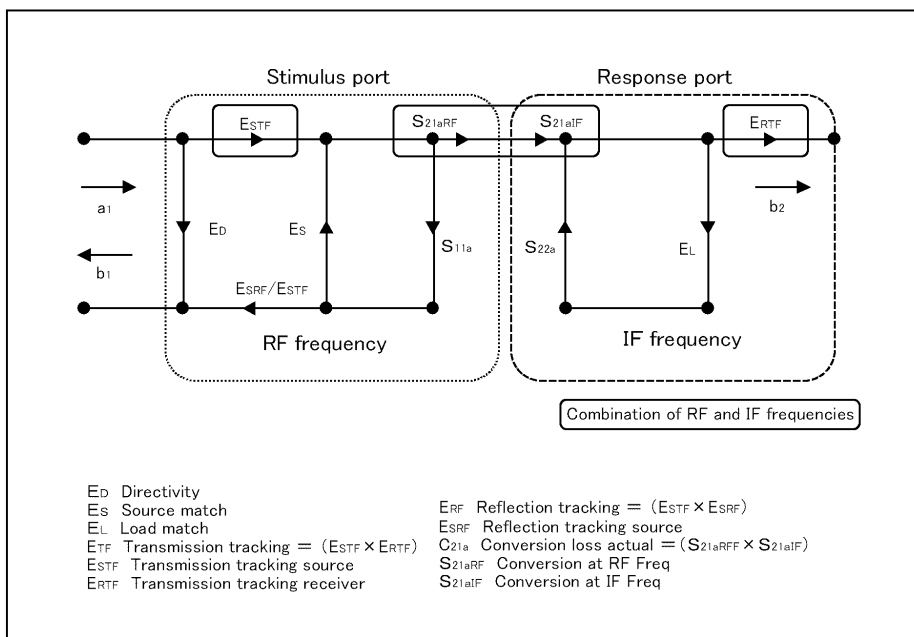

Confirming calibration status

Error correction status of each channel

You can confirm the progress of error correction for each channel by viewing the error calibration status.

The error correction status is displayed in the channel status bar in the lower part of the window by one of the following symbols:

Symbol	Execute status of error correction
Cor (displayed in blue)	Error Correction: On (enabled for all traces)
Cor (displayed in gray)	Error Correction: On (enabled for some traces)
Off (displayed in gray)	Error Correction: Off
--- (displayed in gray)	Error correction: On (no calibration data)
C? (displayed in blue)	Error correction: On (interpolation is being executed or the IF bandwidth, sweep delay time, power level, or sweep type is different from when calibration was executed.)
C! (displayed in blue)	Error correction: On (extrapolation is being executed.)

For the traces in which the scalar-mixer is valid, the status [S2] is added (Figure 4-75).

Figure 4-75

Status indication for the traces in which scalar-mixer is valid

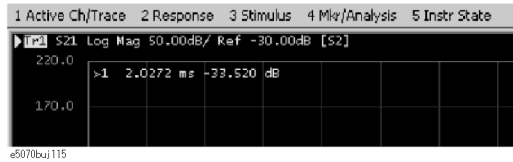

NOTE

In scalar-mixer calibration, the normal calibration coefficient is invalid while the frequency-offset sweep is in progress; in this case the scalar-mixer calibration coefficient is used instead. Turning the frequency-offset sweep (**Frequency Offset**) **OFF** switches over to the normal calibration coefficient; however, the information on the scalar-mixer calibration coefficient is retained.

Operational Procedure (when using mechanical calibration kit)

NOTE

Before starting scalar-mixer calibration, verify that the frequency-offset (**Frequency Offset**) is **ON**. If the frequency-offset is not valid, you cannot start scalar-mixer calibration.

- Step 1.** Press **Channel Next** or **Channel Prev** to select the channel you want to calibrate.
- Step 2.** Press **Cal**.
- Step 3.** Press **Mixer/Converter Calibration**.
- Step 4.** Press **Scalar Cal (Manual)**.
- Step 5.** Press **Select Ports**.
- Step 6.** Select the test port from the list below for starting scalar-mixer calibration. In the following steps, x and y signify the selected test ports.

Softkey	Function
Port 1	Selects test port 1
Port 2	Selects test port 2
Port 3	Selects test port 3
Port 4	Selects test port 4
2-1 (fwd)	Selects forward direction for test ports 1 and 2
1-2 (rev)	Selects reverse direction for test ports 1 and 2
1, 2 (both)	Selects both directions for test ports 1 and 2
3-1 (fwd)	Selects forward direction for test ports 1 and 3
1-3 (rev)	Selects reverse direction for test ports 1 and 3
1, 3 (both)	Selects both directions for test ports 1 and 3
4-1 (fwd)	Selects forward direction for test ports 1 and 4

Calibration
Scalar-Mixer Calibration

Softkey	Function
1-4 (rev)	Selects reverse direction for test port 1 and 4
1, 4 (both)	Selects both directions for test port 1 and 4
3-2 (fwd)	Selects forward direction for test port 2 and 3
2-3 (rev)	Selects reverse direction for test port 2 and 3
2, 3 (both)	Selects both directions for test port 2 and 3
4-2 (fwd)	Selects forward direction for test port 2 and 4
2-4 (rev)	Selects reverse direction for test port 2 and 4
2, 4 (both)	Selects both directions for test port 2 and 4
4-3 (fwd)	Selects forward direction for test port 3 and 4
3-4 (rev)	Selects reverse direction for test port 3 and 4
3, 4 (both)	Selects both directions for test port 3 and 4

NOTE

For the scalar-mixer calibration, only one direction with 2-ports calibration is available. “One direction” means the forward or reverse direction. Two directions may be used among the same ports, but this would not be full 2-port scalar-mixer calibration but simply the simultaneous operation of single-direction scalar-mixer calibrations.

Step 7. The following steps are provided for the case where you have selected both **x** and **y**.

Figure 4-76 Connection of standards in scalar-mixer calibration

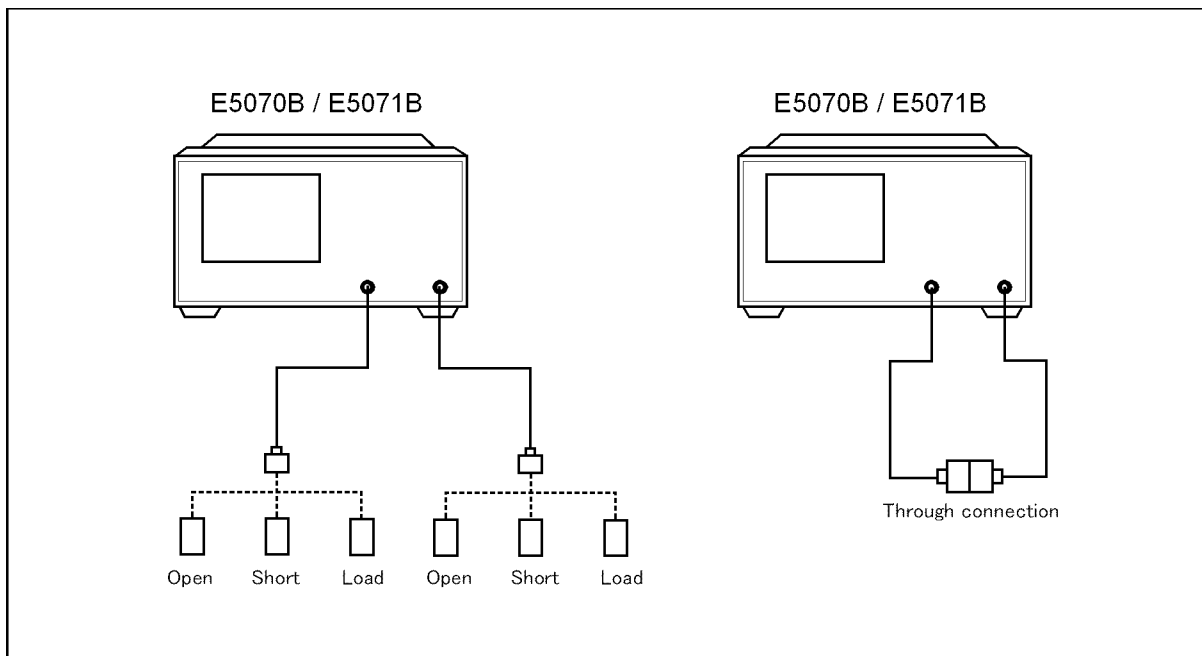

e5070bue120

Step 8. Press **Reflection**.

- Step 9.** Connect the OPEN calibration standard to the test port x (connector for the DUT) you have selected in Step 6.
- Step 10.** Press **Port x @Freq x Open** to start measurement of the calibration standard.
- Step 11.** Press **Port x @Freq y Open** to start measurement of the calibration standard.
- Step 12.** Disconnect the OPEN calibration standard you connected in Step 9 and then connect SHORT calibration standard in its place.
- Step 13.** Press **Port x@Freq x Short** to start measurement of the calibration standard.
- Step 14.** Press **Port x@Freq y Short** to start measurement of the calibration standard.
- Step 15.** Disconnect the SHORT calibration standard you connected in Step 12 and then connect LOAD calibration standard in its place.
- Step 16.** Press **Port x@Freq x Load** to start measurement of the calibration standard.
- Step 17.** Press **Port x@Freq y Load** to start measurement of the calibration standard.
- Step 18.** Follow steps Step 9 to Step 17 for port y.
- Step 19.** Press **Return**.
- Step 20.** Press **Transmission**.
- Step 21.** Connect a THRU between the test ports x and y (between the connectors for the DUT) you selected in Step 6.
- Step 22.** Press **Port y-x@Freq y Thru** to start measurement of the calibration standard.
- Step 23.** Press **Port x-y@Freq x Thru** to start measurement of the calibration standard.
- Step 24.** Press **Return**.
- Step 25.** Press **Power Meter**.

NOTE

In scalar-mixer calibration, the power meter is used. For more on how to set the power meter, see “Preparing to control the power meter” on page 210.

- Step 26.** Press **Use Sensor**. Each time the key is pressed, Channels A and B switch over alternately. If you are using a one-channel power meter, select Channel A.
- Step 27.** Connect the power sensor for the selected channel to the selected port, as shown in Figure 4-77.

Figure 4-77

Connection of power sensor

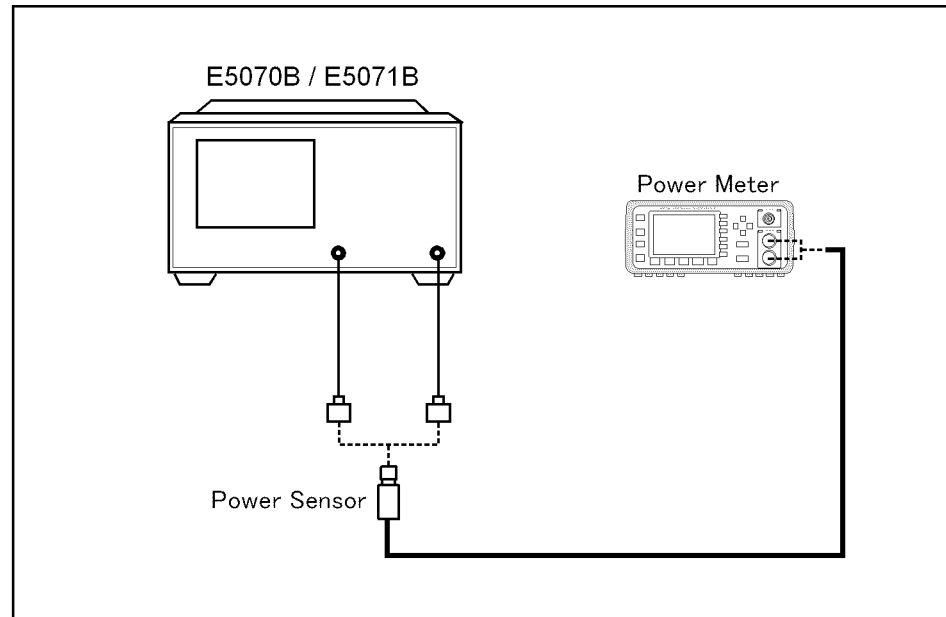

- Step 28. Press **Port x@Freq x**.
- Step 29. Press **Port x@Freq y**.
- Step 30. Press **Port y@Freq x**.
- Step 31. Press **Port y@Freq y**.
- Step 32. Press **Return**.
- Step 33. Press **Done** to exit the scalar-mixer calibration. This step allows the calibration coefficient to be calculated, turning on the error correction function automatically.

Operational procedure (when using ECal module)

To start calibration, refer to “Operational Procedure (when using mechanical calibration kit)” on page 235; the steps up to Step 7 in that procedure are common to this procedure.

- Step 1. Select a test port and then press **Power Meter**.

NOTE

In scalar-mixer calibration, the power meter is used. For more information on how to set the power meter, see “Preparing to control the power meter” on page 210.

- Step 2. Press **Use Sensor**. Each time the key is pressed, Channels A and B switch over alternately. If you are using a one-channel power meter, select Channel A.
- Step 3. Connect the power sensor for the selected channel to the selected port, as shown in Figure 4-78.

Figure 4-78

Connection of power sensor

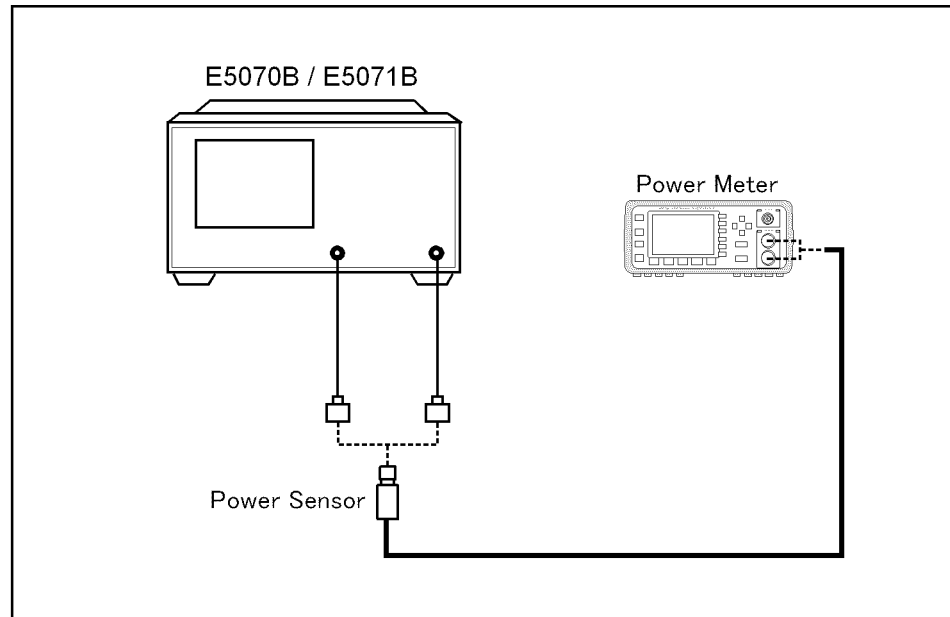

e5070bue019

- Step 4. Press **Port x@Freq x**.
- Step 5. Press **Port x@Freq y**.
- Step 6. Press **Port y@Freq x**.
- Step 7. Press **Port y@Freq y**.
- Step 8. Press **Return**.
- Step 9. Connect the test port you selected in Step 1 to the ECal module, as shown in Figure 4-79, and then press **ECal & Done**.

NOTE

If the ECal module is not connected to the E5070B/E5071B, the **ECal & Done** menu item will not be available. In addition, if the ECal module is not connected to the test port of the calibration target, an error may occur. For information on connecting the ECal module, see “ECal (electronic calibration)” on page 127.

Figure 4-79

Connection of ECal Module

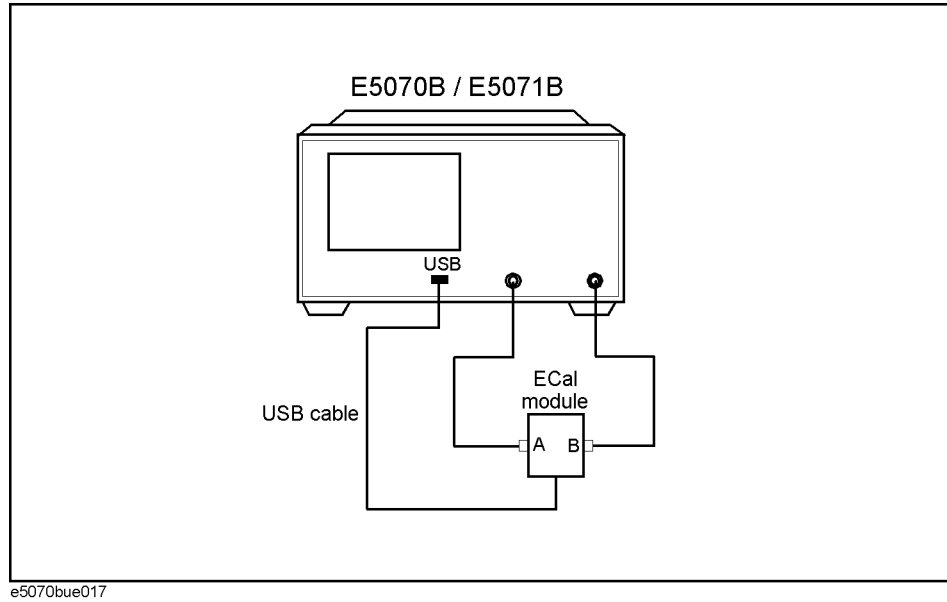

Step 10. The above steps allow the calibration coefficient to be calculated, turning on the error correction function automatically.

5 Making Measurements

This chapter explains how to carry out measurements with the Agilent E5070B/E5071B by using the trigger function.

Setting Up the Trigger and Making Measurements

The E5070B/E5071B has one trigger source. When this trigger source detects a trigger signal that has occurred, a sweep is performed for channels in the “Initiate” state in the order of channel 1 to channel 16. You set the “Initiate” or “Idle” status of each channel by changing the trigger mode. For details on the trigger system, refer to *Programmer's Guide*.

NOTE

The execution of measurement for each channel does not depend on whether the channel is displayed. Channels that have been activated can be measured even if they are not displayed.

For each channel, a sweep is performed only for the stimulus ports needed to update the parameters of the displayed trace.

Sweep Order in Each Channel

In a channel, each test port is set to a stimulus port in the order of port number and updates each trace (Table 5-1).

Table 5-1 Sweep Order in Each Channel

Sweep Order	Stimulus Port	Updated Trace
↓	Port 1	S11, S21, S31 ^{*1} , S41 ^{*2}
	Port 2	S12, S22, S32 ^{*1} , S42 ^{*2}
	Port 3 ^{*1}	S13 ^{*1} , S23 ^{*1} , S33 ^{*1} , S43 ^{*2}
	Port 4 ^{*2}	S14 ^{*2} , S24 ^{*2} , S34 ^{*2} , S44 ^{*2}

*1. Option 313, 314, 413, or 414 only
 *2. Option 413 or 414 only

NOTE

If full 2-, 3-, or 4-port error correction is in effect, no trace between calibrated ports is updated until the last calibrated port is swept as the stimulus port.

Sweep is not executed for stimulus ports that are not required for updating traces.

Trigger Source

The trigger source generates a cue signal that initiates a measurement process. Four types of trigger sources are available as shown in Table 5-2.

Table 5-2 **Trigger Sources**

Trigger Sources	Function
Internal (Internal)	Uses a consecutive signal generated by the firmware as a trigger source. Triggers are sent immediately following the completion of each measurement.
External (External)	Uses the external trigger input terminal (BNC) as a trigger source.
Manual (Manual)	A trigger is generated by pressing Trigger - Trigger .
Bus (Bus)	A trigger is generated by executing a *TRG command.

Trigger Modes

You can set the trigger mode for each channel independently. This allows you to control the operation of each channel after a trigger signal is detected by setting the channel's status with the trigger mode.

Table 5-3 **Trigger mode**

Trigger mode name	Function
Sweep stop (Hold)	The status ("Idle" status) in which the sweep is stopped. When a trigger signal is detected, the sweep is not performed.
Single sweep (Single)	An "Initiate" status. When a trigger signal is detected, a sweep is performed. After completion of the sweep, the "Idle" status is activated.
Continuous sweep (Continuous)	An "Initiate" status. When a trigger signal is detected, a sweep is performed. After completion of the sweep, the "Initiate" status is maintained. The sweep is repeated each time a trigger signal is detected.

Setting Up the Trigger and Making Measurements

1. Selecting a Trigger Source

Follow the procedure below to select a trigger source.

- Step 1.** Press Trigger.
- Step 2.** Press **Trigger Source**.

Making Measurements

Setting Up the Trigger and Making Measurements

Step 3. Press the softkey that corresponds to the desired trigger source.

Softkey	Function
Internal	Selects internal trigger source
External	Selects external trigger source
Manual	Selects manual trigger source
Bus	Selects bus trigger source

2. Selecting a Trigger Mode

Follow the procedure below to select a trigger mode.

Step 1. Press **Channel Next** (or **Channel Prev**) to select the channel for which the trigger mode will be set.

Step 2. Press **Trigger**.

Step 3. Press the softkey that corresponds to the desired trigger mode.

Softkey	Function
Hold	Sets active channel trigger mode to hold sweep mode
Single	Sets active channel trigger mode to single sweep mode
Continuous	Sets active channel trigger mode to continuous sweep mode
Hold All Channels	Sets all channel trigger modes to hold sweep mode
Continuous Disp Channels	Sets trigger modes of all displayed channels (Display - Display) to continuous sweep mode

Step 4. Repeat Step 1 to Step 3 until each channel is set for its trigger mode.

3. Generating the Trigger

Next, it is necessary to generate a trigger by using the trigger source selected in “1. Selecting a Trigger Source” on page 243.

NOTE

Once the internal trigger source is selected, a series of triggers is continuously generated as soon as the setting becomes effective.

Pressing **Trigger** - **Restart** during a sweep forces the analyzer to abort the sweep.

Setting the Point Trigger

The point trigger provides a point measurement at every trigger, and it can be used to change the trigger event to point trigger mode.

Table 5-4

Trigger mode

Trigger event name	Function
On (On Point)	Point measurement is performed when trigger is applied.
Off (On Sweep)	Measurement is performed for all measurement points when trigger is applied.

NOTE

When the trigger source is selected as the internal trigger, the point trigger does not work.

Procedure to Set the Point Trigger

1. Selecting a Trigger Event

Follow the procedure below to select a trigger event.

Step 1. Press **Trigger**.

Step 2. Press **Trigger Event**.

Step 3. Press the softkey that corresponds to the desired trigger event.

Softkey	Function
On Point	Measures at each measurement point
On Sweep	Measures all measurement points

Setting the low-latency external trigger mode

In the low-latency external trigger mode, variations in delay time between the reception of a trigger and the start of a one-point measurement are decreased for point trigger measurement by using trigger pulses supplied to the external trigger input terminal. In addition, using this mode will allow you to decrease the variations in the time required to be ready for the next measurement trigger after execution of a one-point measurement. This mode allows you to perform continuous point trigger measurement in sync with external trigger pulses and accurately set a trigger delay time at each point-trigger point.

NOTE

The time required for measurement at each measurement point varies depending on the settings of the E5070B/E5071B and the type of measurement. For more information, see “External trigger delay time and point trigger interval” on page 247.

The low-latency external trigger mode becomes available by turning on the point trigger function and setting the trigger source to “External.”

Table 5-5 Low-latency external trigger mode

Low-latency external trigger mode	Function
On	Sets the low-latency external trigger mode to ON. The external trigger delay time becomes valid.
Off	Sets the low-latency external trigger mode to OFF.

NOTE

If the trigger source is not the external trigger, the low-latency external trigger mode does not work if it is specified to ON.

The setting of the low-latency external trigger mode is valid for all channels.

Procedure to set the low-latency external trigger

1. Setting the low-latency external trigger

If the trigger source is set to “External” and the trigger event to “On” (On Point), set the low-latency external trigger mode.

Step 1. Press **Trigger**.

Step 2. Press **Low Latency**.

Softkey	Function
ON	Sets the-low latency external trigger mode to ON.
OFF	Sets the-low latency external trigger mode to OFF.

2. Setting the external trigger delay time

Set the external trigger delay time at each point. The setting resolution is 10 μ s.

- Step 1.** Press **Trigger**.
- Step 2.** Press **Ext Trig Delay**.
- Step 3.** Enter an external trigger delay time.

External trigger delay time and point trigger interval

External trigger pulses, supplied until the next measurement becomes ready after the start of a one-point measurement, are ignored, and the next trigger is generated by a pulse supplied after the completion of the one-point measurement.

The time until the next trigger can be accepted after the start of a one-point measurement depends on the IFBW and other settings of the analyzer. For example, in the case of a frequency's zero-span measurement, the time until the next measurement is ready after the start of a one-point measurement is obtained by dividing the time required for a single sweep in On Sweep mode, instead of On Point mode, by the number of measurement points. If you use the point trigger function with external trigger pulses that are wider than this time, point trigger measurement is performed at each pulse input.

The figure below shows the timing chart of an external trigger when the point trigger function is on.

Figure 5-1 Timing chart of external trigger (trigger event = on, trigger source = external, low-latency external trigger mode = on)

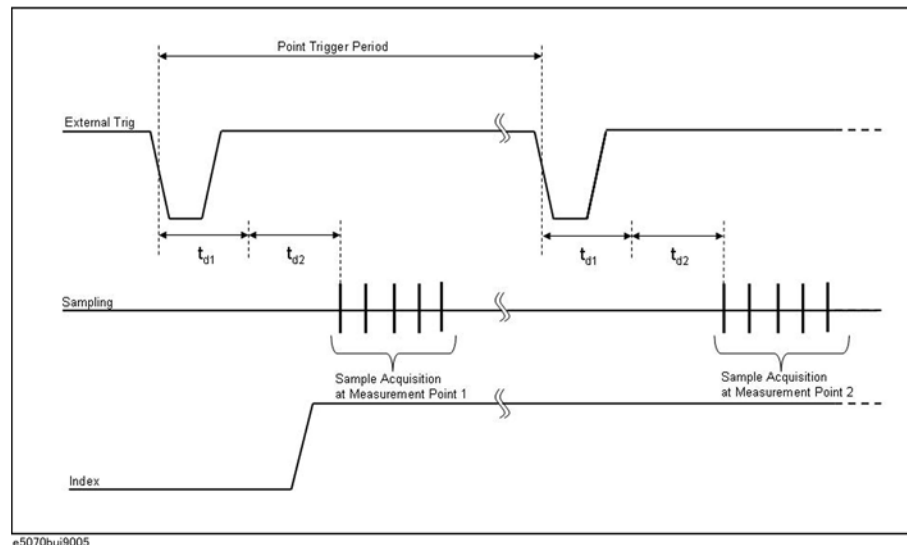

e5070buuj9005

The table below describes signals and times in the figure.

Signal, time	Description
External Trig	External trigger signal to be supplied.
Sampling	Time while the E5070B/E5071B is actually performing measurement.
Index	/Index signal of the handler I/O port. When the point trigger function is ON and the low-latency external trigger mode is ON, it goes to the High level only before starting measurement of the first sweep point and returns to the Low level after completing measurement of all measurement points.
Point Trigger Period	Time until the E5070B/E5071B is ready to accept a trigger for the next measurement point. The value depends on the measurement conditions and the settings of the E5070B/E5071B.
td1	Time set as the external trigger delay time.
td2	Time that the E5070B/E5071B requires internally for setting. This depends on the settling time for setting the frequency, IF frequency band, and so on. For zero-span measurement, td2 = about 150 μ s (reference value).

Setting the Averaging Trigger Function

The averaging trigger function is used to execute the sweep the number of times specified by the averaging factor with a single trigger when the sweep averaging function is ON.

Averaging trigger	Function
On	Performs the sweep the number of times specified by the averaging factor with a single trigger.
Off	Performs the sweep once with a single trigger.

The averaging factor is cleared before the start of measurement.

NOTE

When the point trigger function is on, its setting has priority, and you need to generate triggers based on “(number of measurement points)×(averaging factor)”.

When the sweep averaging function is off, sweep is performed only once even if the averaging trigger function is set to on.

The averaging trigger function is valid for all channels. Note that you can set the sweep averaging function for each channel.

Using the averaging trigger function

1. Setting the averaging trigger function

When the sweep averaging function is on, follow these steps to set the averaging trigger function.

Step 1. Press **Avg** .

Step 2. Press **Avg Trigger**.

Softkey	Function
ON	Sets the averaging trigger function to ON.
OFF	Sets the averaging trigger function to OFF.

2. Executing averaging measurement

Step 1. Press **Trigger**.

Step 2. Press **Single**. The averaging factor is cleared before the start of measurement, the sweep is executed the number of times specified by the averaging factor, and then the instrument waits for the next trigger.

Executing a Trigger Only for Active Channel

Follow the procedure below to set the effective range of a trigger.

Procedure to set the range

Step 1. Press **Trigger**.

Step 2. Press **Trigger Scope**.

Softkey	Function
All Channel	A trigger is executed for all channels.
Active Channel	A trigger is executed only for the active channel.

NOTE

When you set the effective range of a trigger to “Active Channel” when the trigger mode is continuous sweep mode (INIT:CONT:ON), the channel to be triggered is changed only by swtching channels.

6 **Data Analysis**

This chapter explains how to use the analytical functions of the Agilent E5070B/E5071B.

Analyzing Data on the Trace Using the Marker

About marker functions

The marker can be used in the following ways:

- Reading a measured value as numerical data (as an absolute value or a relative value from the reference point)
- Moving the marker to a specific point on the trace (marker search)
- Analyzing trace data to determine a specific parameter
- Using the value of the marker to change the stimulus (sweep range) and scale (value of the reference line)

For the procedure used to change the sweep range and scale by using the marker, refer to “Setting the Sweep Range Using the Marker” on page 71 and “Setting the value of a reference line using the marker” on page 87.

The E5070B/E5071B is capable of displaying up to 10 markers on each trace. Each marker has a stimulus value (the value on the X-axis in rectangular display format) and a response value (the value on the Y-axis in rectangular display format). The Smith chart and polar formats each have two marker response values (log amplitude and phase).

Reading values on the trace

You can read the value of a marker displayed on the trace.

In rectangular display format, the marker response value is always in the same data format as that of the Y-axis. On the contrary, one format for the marker response values (two values: main and auxiliary) can be selected from among several types. The selection is performed in the data format.

Table 6-1

Marker Response Values for Smith Chart/Polar Data Formats

Softkey for selecting data format	Marker response value	
	Main	Auxiliary
Smith - Lin / Phase	Linear amplitude	Phase
Smith - Log / Phase	Log amplitude	Phase
Smith - Real / Imag	Real component	Imaginary component
Smith - R + jX	Resistance	Reactance ^{*1}
Smith - G + jX	Conductance	Susceptance ^{*1}
Polar - Lin / Phase	Linear amplitude	Phase
Polar - Log / Phase	Log amplitude	Phase
Polar - Real / Imag	Real component	Imaginary component

*1. Inductance or capacitance is also displayed.

For setting up data formats, refer to “Selecting a Data Format” on page 81.

Reading a Value on the Trace

- Step 1. Press **Channel Next** or **Channel Prev** to activate the channel on which a marker is used.
- Step 2. Press **Trace Next** or **Trace Prev** to activate the trace on which a marker is used.
- Step 3. Press **Marker**.

NOTE

At this point, marker 1 is turned on and becomes active (you can operate the marker). When using marker 1, you can omit Step 4.

Step 4. Select a marker and turn it on. The softkey used to turn on a marker is also used to activate that marker.





Softkey	Function
Marker 1	Turns on marker 1 and activates marker 1
Marker 2	Turns on marker 2 and activates marker 2
Marker 3	Turns on marker 3 and activates marker 3
Marker 4	Turns on marker 4 and activates marker 4
More Markers - Marker 5	Turns on marker 5 and activates marker 5
More Markers - Marker 6	Turns on marker 6 and activates marker 6
More Markers - Marker 7	Turns on marker 7 and activates marker 7
More Markers - Marker 8	Turns on marker 8 and activates marker 8
More Markers - Marker 9	Turns on marker 9 and activates marker 9
Ref Marker	Turns on the reference marker and activates reference marker



Step 5. Change the marker stimulus value in the entry area. This operation enables you to move the marker to a point on the desired trace.

The value in the entry area can be changed by one of the following methods.

NOTE

To change the value in the entry area, the figure in the box should be highlighted. If the figure is not highlighted, press the softkey for the marker you are using (**marker 1 to marker 9, Ref Marker**) or **Focus** to highlight the figure.

- Enter a numeric value using the ENTRY block key on the front panel.
- Turn the rotary knob () on the front panel.
- Press the up or down arrow key ( ) on the front panel.
- Using the mouse, click one of the buttons ( ) on the right side of the entry area.

You can move the marker by dragging and dropping either one of the marker position pointers above and below the graph ( ) (pressing the button on the object to be moved and releasing the button on the destination). In rectangular display format, you can move a marker itself by dragging and dropping it.

Step 6. When using other markers, repeat Step 4 and Step 5.

Step 7. Read the marker stimulus value and marker response value displayed in the upper-left part of the trace screen.

Step 8. To turn off marker(s), press the **Clear Marker Menu** and then press one of the softkeys as follows:

Softkey	Function
All OFF	Turns off all of the markers on the active trace
Marker 1 to Marker 9	Turns off one of markers 1 through 9 on active trace
Ref Marker	Turns off reference markers on active trace

NOTE

In the preset configuration, the marker settings on traces in a channel are coupled (Marker Couple is turned on). For marker coupling, refer to “Setting up markers for each trace/Setting up markers for coupled operations between traces” on page 258.

Reading the Relative Value From the Reference Point on the Trace

You can convert the marker reading into a relative value from the reference point.

Figure 6-1 Delta marker mode

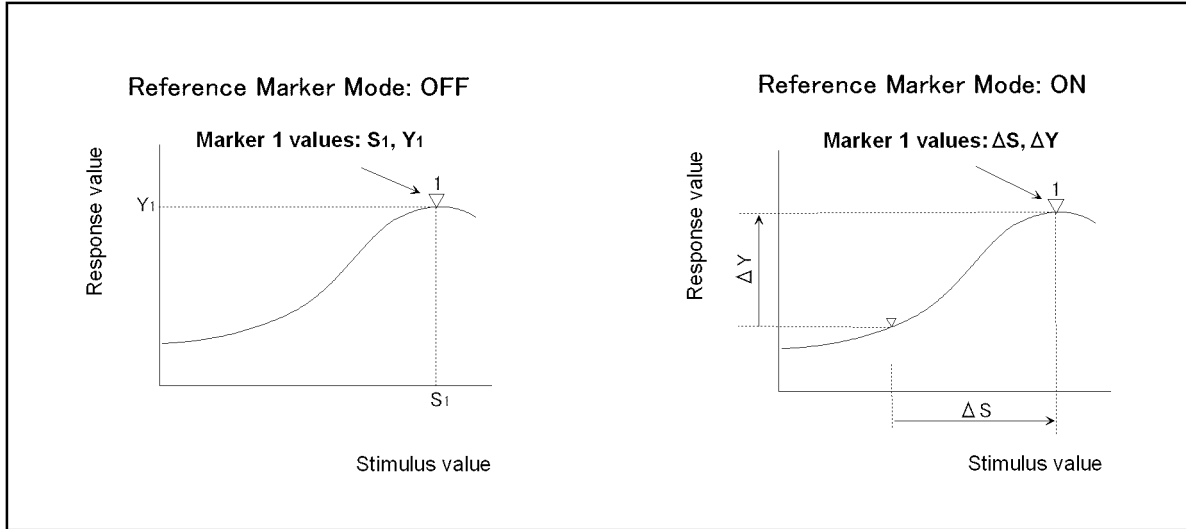

e5070aue121

Converting From a Reference Point to a Relative Value

- Step 1.** Following Step 1 to Step 5 in “Reading values on the trace” on page 253, place the reference marker on the point to be used as the reference.
- Step 2.** Press **Ref Marker Mode** to turn on the reference mode.
With the reference mode turned on, the stimulus values and response values are indicated in relative values referred to by the position of the reference marker.
- Step 3.** Following Step 4 to Step 5 in “Reading values on the trace” on page 253, place markers 1 through 9 on the desired points to read the values.

NOTE

Pressing **Marker** → **Ref Marker** enables you to place the reference marker at the position of the currently active marker. The reference mode will then turn on automatically.

Reading only the actual measurement point/Reading the value interpolated between measurement points

The point on the trace on which a marker can be placed differs depending on how the discrete marker mode is set up.

Turning on discrete mode (Discrete ON)

A marker moves only between actual measurement points. When a specific marker stimulus value is specified as a numerical value, the marker is placed at the measurement point closest to the specified value. A marker that is placed between interpolated points with the discrete mode off automatically moves to the nearest measurement point when the discrete mode is turned on.

Turning off discrete mode (Discrete OFF)

The marker can move from one actual measurement point to another. Because it is interpolated, it can also move in the space between measurement points.

Figure 6-2

Marker discrete mode

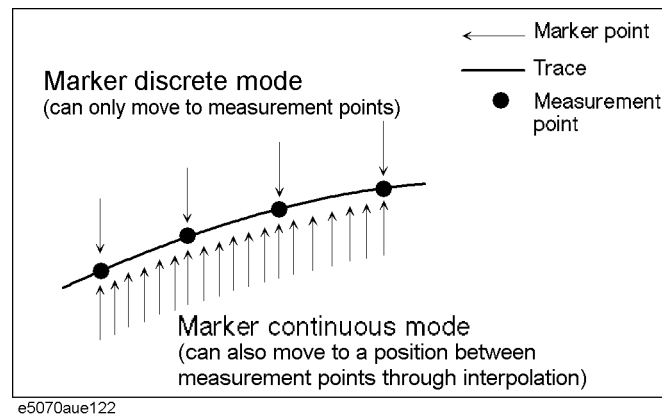

Turning Discrete Mode On or Off

- Step 1.** Press **Channel Next** (or **Channel Prev**) and **Trace Next** (or **Trace Prev**) to activate the trace on which the discrete mode is set up.
- Step 2.** Press **Marker Fctn**.
- Step 3.** Press **Discrete** to turn the discrete mode on or off.

Setting up markers for each trace/Setting up markers for coupled operations between traces

Makers can be set up and moved either in coupled operation for all traces in a channel or independently for each trace.

Figure 6-3

Marker coupling

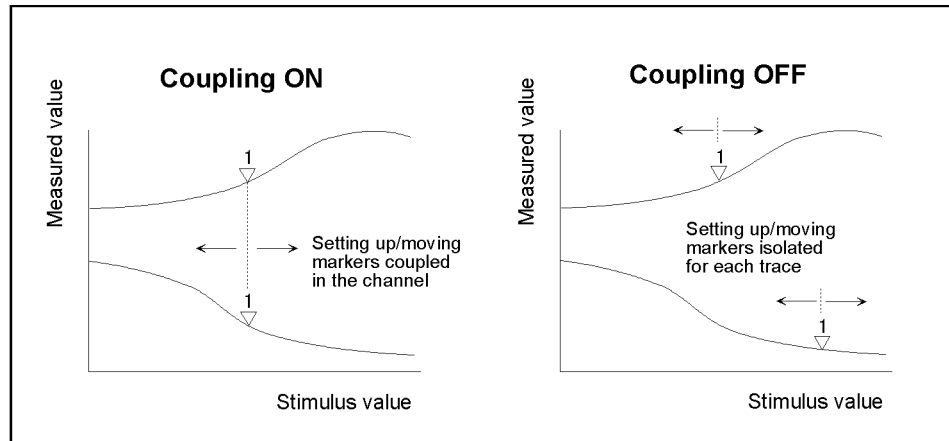

e5070aue049

**Marker Couple is on
(Coupling ON)**

Markers are set up and moved in coupled operation on all traces in a channel.

**Marker Couple is off
(Coupling OFF)**

Markers are set up and moved independently for each trace.

Turning Marker Coupling On or Off

- Step 1.** Press **Channel Next** (or **Channel Prev**) to activate the channel on which the marker couple will be set.
- Step 2.** Press **Marker Fctn**.
- Step 3.** Press **Couple** to turn the marker coupling on or off.

Listing all marker values in all channels displayed

You can list all of the marker values in all of the displayed channels on the screen.

Turning On the Marker Table Display

- Step 1. Press **Marker Fctn**.
- Step 2. Press **Marker Table** to turn on the marker table display.

The marker table appears in the lower part of the screen (Figure 6-4).

Figure 6-4

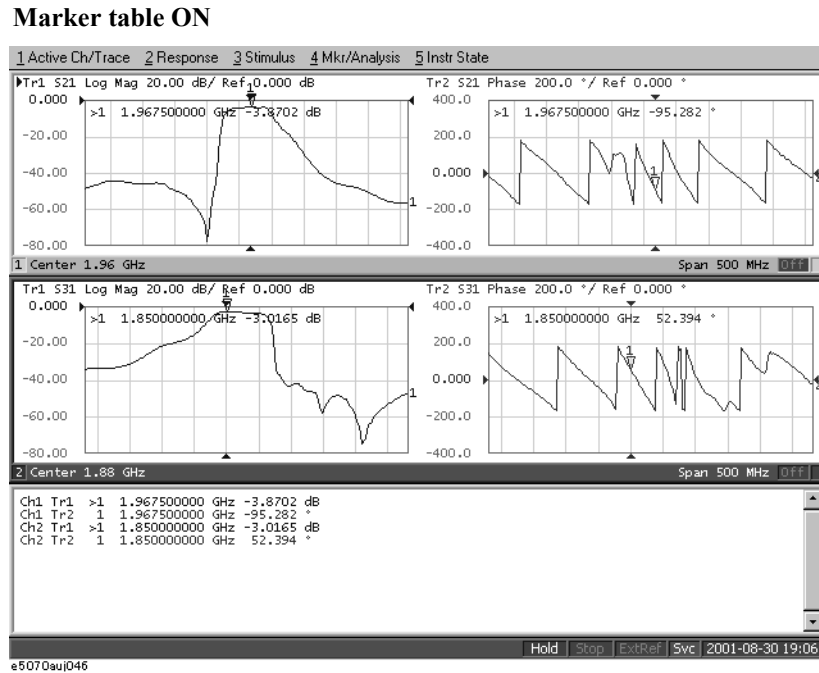

Specifying the display position of marker values

This section describes how to specify the marker value display position as a percentage for each active trace.

Figure 6-5

Marker coupling

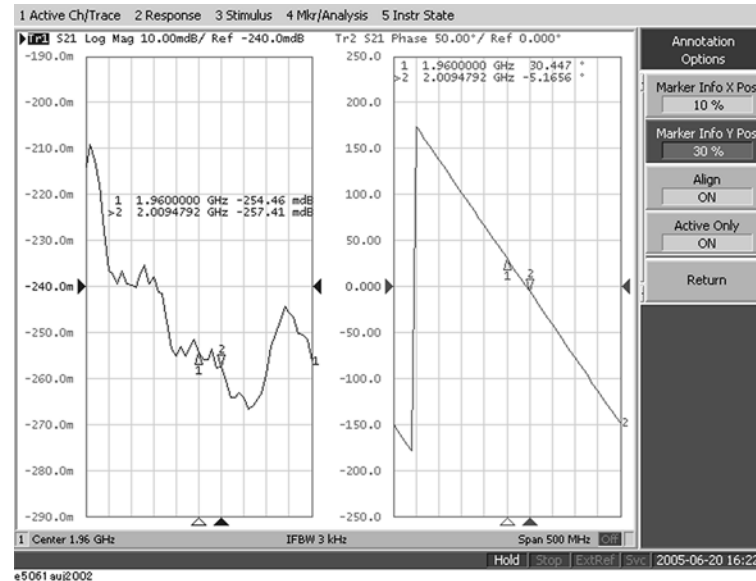

Marker Info X Pos Specifies the horizontal display position by the width of the display area as a percentage.

Marker Info Y Pos Specifies the vertical display position by the height of the display area as a percentage.

Operational procedure

- Step 1.** Press **Channel Next** (or **Channel Prev**) to activate the channel for which you want to set marker coupling.
- Step 2.** Press **Marker Fctn**.
- Step 3.** Press **Annotation Options**.
- Step 4.** Press **Marker Info X Pos** to set the horizontal display position.
- Step 5.** Press **Marker Info Y Pos** to set the vertical display position.

Aligning maker value displays

This section describes how to align maker value displays.

Figure 6-6

Marker coupling

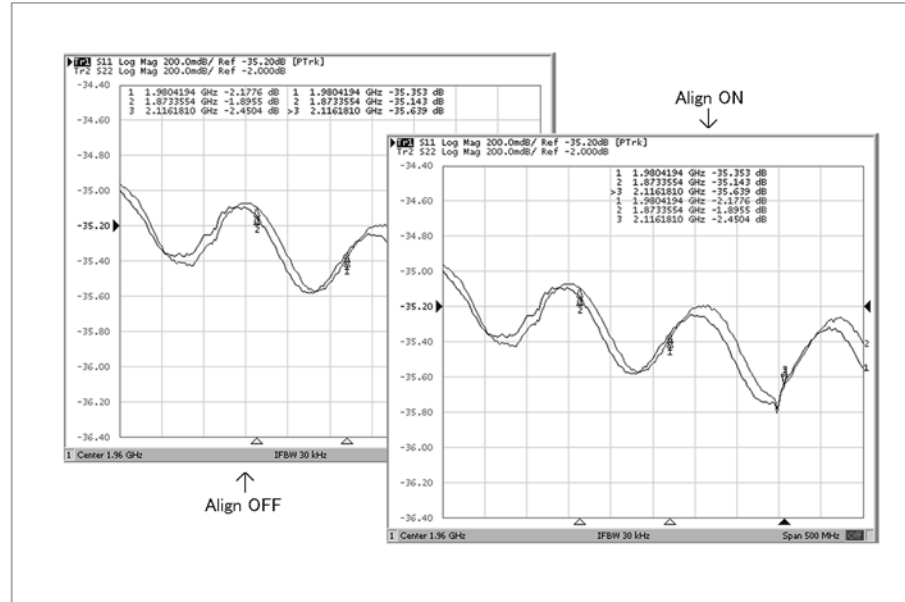

On
(Align ON)

Displays marker values to align to the display position of trace 1.

Off
(Align OFF)

Displays marker values in the display position defined for each trace.

Operational procedure

- Step 1. Press **Marker Fctn**.
- Step 2. Press **Annotation Options**.
- Step 3. Press **Align** to toggle on/off.

Displaying all marker values for displayed traces

This section describes how to display all marker values for displayed traces.

Figure 6-7

Marker coupling

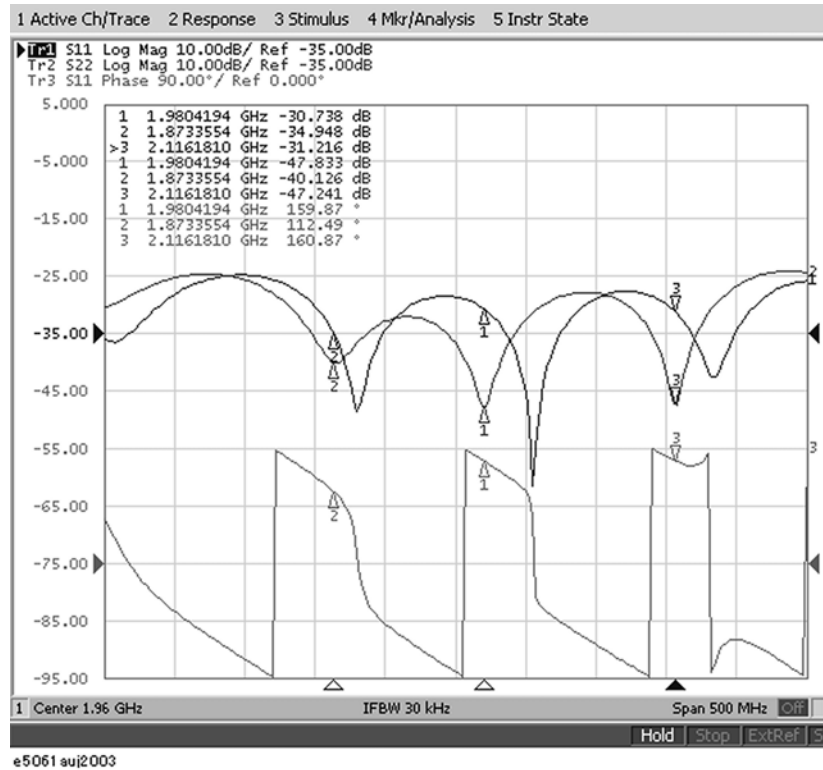

**Display all
 (Active Only OFF)**

Displays all marker values for displayed traces.

**Displays active markers
 (Active Only ON)**

Displays markers for the active trace only.

Operational procedure

- Step 1. Press **Marker Fctn**.
- Step 2. Press **Annotation Options**.
- Step 3. Press **Active Only** to toggle on/off.

Searching for Positions that Match Specified Criteria

You can search for a position that matches your specified criteria by using the Marker Search feature.

Marker Search allows you to search for a position that matches any of the following criteria.

- Maximum value
- Minimum value
- Target (a point that has a target measurement value)
 - Target nearest to marker position
 - Target on left-hand side nearest to marker position
 - Target on right-hand side nearest to marker position
- Peak
 - Maximum peak (for a positive peak), minimum peak (for a negative peak)
 - Peak on left-hand side nearest to marker position
 - Peak on right-hand side nearest to marker position

Setting search range

The Marker Search feature allows you to set part of the sweep range as the search target (Partial Search feature) as well as the entire search range. For the Partial Search feature, you can select whether to couple traces in the channel.

Procedure to Turn On/Off Trace Coupling within Search Range

- Step 1.** Press **Channel Next** or **Channel Prev** to activate the channel for which you want to set the search range.
- Step 2.** Press **Trace Next** or **Trace Prev** to activate the trace for which you want to set the search range.
- Step 3.** Press **Marker Search**.
- Step 4.** Press **Search Range**.
- Step 5.** Press **Couple** to toggle on/off trace coupling within the search range.

Procedure to Set Search Range

- Step 1.** Press **Channel Next** or **Channel Prev** to activate the channel for which you want to set the search range.
- Step 2.** If the trace coupling within the search range is off, press **Trace Next** or **Trace Prev** to activate the trace for which you want to set the search range.
- Step 3.** Press **Marker Search**.
- Step 4.** Press **Search Range**.
- Step 5.** Press **Search Range** to turn on the Partial Search feature.
- Step 6.** Press **Start**.
- Step 7.** Enter the start value (lower limit) of the search range using the ENTRY block keys on the front panel.
- Step 8.** Press **Stop**.
- Step 9.** Enter the stop value (upper limit) of the search range using the ENTRY block keys on the front panel.

Automatically executing a search each time a sweep is done (search tracking)

Search tracking is a function that sets a search to be repeated every time a sweep is done even if the execution key for the search (maximum, minimum, peak, and target) is not pressed. This function facilitates observation of measurement results such as the maximum value of traces (e.g., the insertion loss of a band pass filter).

Performing Search Tracking

- Step 1.** Press **Channel Next** (or **Channel Prev**) and **Trace Next** (or **Trace Prev**) to activate the trace on which you want to set up search tracking.
- Step 2.** Press **Marker Search**.
- Step 3.** Press **Tracking** and turn the search tracking function on or off.

Searching for the maximum and minimum measured values

You can search for the maximum or minimum measured value on the trace and move a marker to that point (Figure 6-8).

Figure 6-8

Searching for maximum and minimum measured values

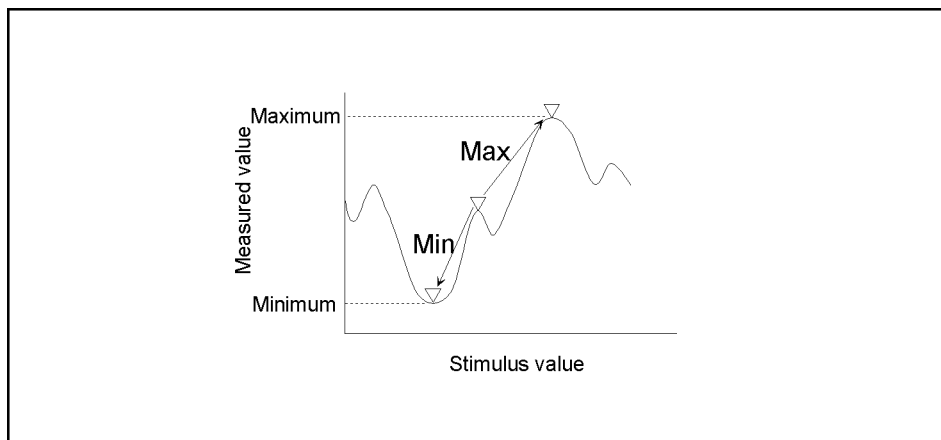

e5070aue047

- | | |
|---------------------------------|---|
| Search for maximum (Max) | Move active marker to point on trace where measured value is greatest |
| Search for minimum (Min) | Move active marker to point on trace where measured value is lowest |

Searching for Maximum and Minimum Values

- Step 1.** Following Step 1 to Step 4 in “Reading values on the trace” on page 253, activate the marker you are using to search for the maximum and minimum values.
- Step 2.** Press **Marker Search**.
- Step 3.** Press the corresponding softkey to move the marker to the maximum or minimum measured value.

Softkey	Function
Max	Performs a search for the maximum value
Min	Performs a search for the minimum value

NOTE When the data format is in Smith chart or polar format, execute the search only for the main response value.

Searching for the target value (target search)

The target search function enables you to move the marker to the point having the target measured value.

Target and Transition Types

A target is a point that has a specific measured value on the trace. Targets can be divided into the two groups shown below depending on their transition type.

Transition type: Positive (Positive) When the value of the target is larger than the measured value that immediately precedes it (on the left side)

Transition type: Negative (Negative) When the value of the target is smaller than the measured value that precedes immediately it (on the left side)

Figure 6-9

Target and transition types

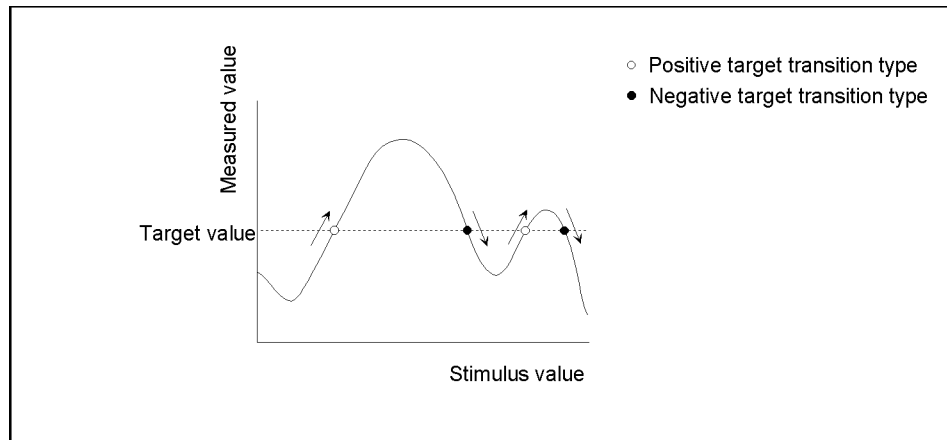

e5070aue050

About the target search function

The target search is a function that searches for a target that matches the pre-defined target value and transition type(s) (positive, negative, or both positive and negative) and then moves the marker to that target.

The following three methods are available for executing the target search:

Target search (Search Peak) The marker moves to the peak with maximum response value if the peak polarity is **Positive** or **Both** or to the peak with minimum response value if the peak polarity is **Negative**.

Search left (Search Left) Executes the search from the current marker position to the smaller stimulus values and moves the marker to first target encountered.

Search right (Search Right) Executes the search from the current marker position to the larger stimulus values and moves the marker to first target encountered.

Figure 6-10

Target search (when transition type is set to “both positive and negative”)

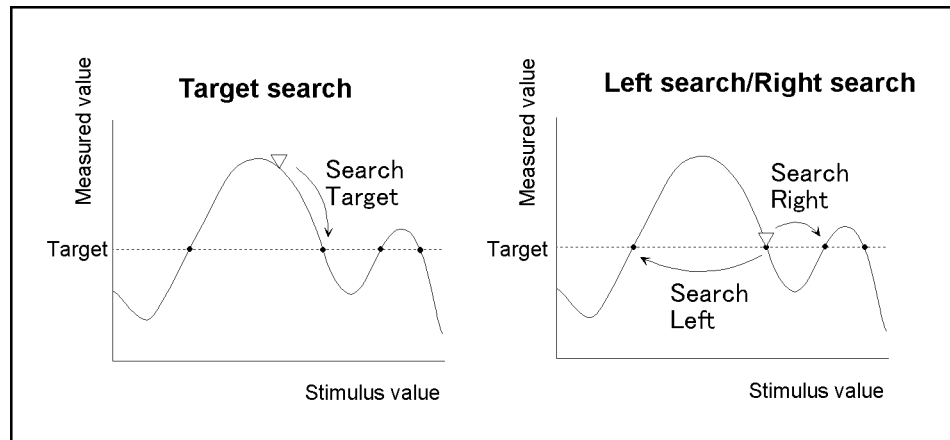

e5070aue048

Executing a Target Search

Step 1. Following Step 1 to Step 4 in “Reading values on the trace” on page 253, activate the marker you are using for the target search.

Step 2. Press **Marker Search**.

Step 3. Press **Target**.

Step 4. Press **Target Value** and enter the target value in the entry area that appears.

This causes the target search to be executed based on the definitions of the newly set target value and the currently set transition type.

Step 5. Press **Target Transition**.

Step 6. Select a transition type.

Softkey	Function
Positive	Selects Positive as transition type
Negative	Selects Negative as transition type
Both	Selects Both Positive and Negative as transition type

This sets the target search to be executed based on the definitions of the currently set target value and the newly set transition type.

Step 7. Press the corresponding softkey to move the marker to the target.

Softkey	Function
Search Target	Executes target search
Search Left	Executes left search
Search Right	Executes right search

NOTE

When the data format is in Smith chart or polar format, execute the search for the main response value of the two marker response values.

Searching for the peak

The peak search function enables you to move the marker to the peak on the trace.

Definition of the peak

A peak is a measurement point whose value is greater or smaller than the adjoining measurement points on its right and left sides. Peaks are classified into the following two types depending on the difference in magnitude from the measurement points on either side of it.

Positive peak (Positive)	A peak whose measured value is greater than those of the measurement points on either side of it (peak polarity: positive)
Negative peak (Negative)	A peak whose measured value is smaller than those of the measuring points on either side of it (peak polarity: negative)

About the peak search function

The peak search is a function that searches for a peak that matches a pre-defined lower limit for the peak excursion value and peak polarity (positive or negative) and then moves the marker to the peak being searched.

The peak excursion value is the smaller of the differences in measured values from the adjoining peaks of the opposite polarity.

Figure 6-11

Positive peak/Negative peak and peak excursion value

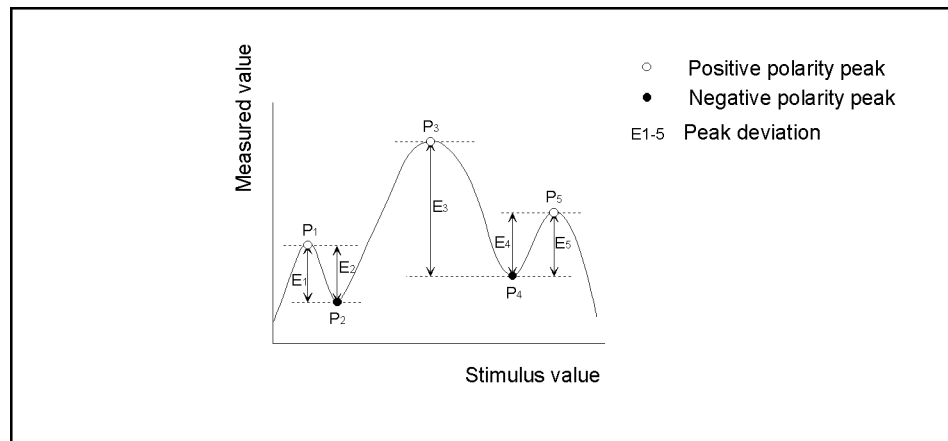

e5070aue051

The following three methods are available for executing the peak search:

Peak search (Search Peak)	Moves the marker to the maximum peak when peak polarity is Positive or Both . Moves the marker to the minimum peak when peak polarity is Negative .
Left search (Search Left)	Executes the search from current marker position to the smaller stimulus values and moves the marker to first peak encountered.
Right search (Search Right)	Execute the search from current marker position to the larger stimulus values and moves the marker to first peak encountered.

Figure 6-12

Peak search (when peak polarity is positive)

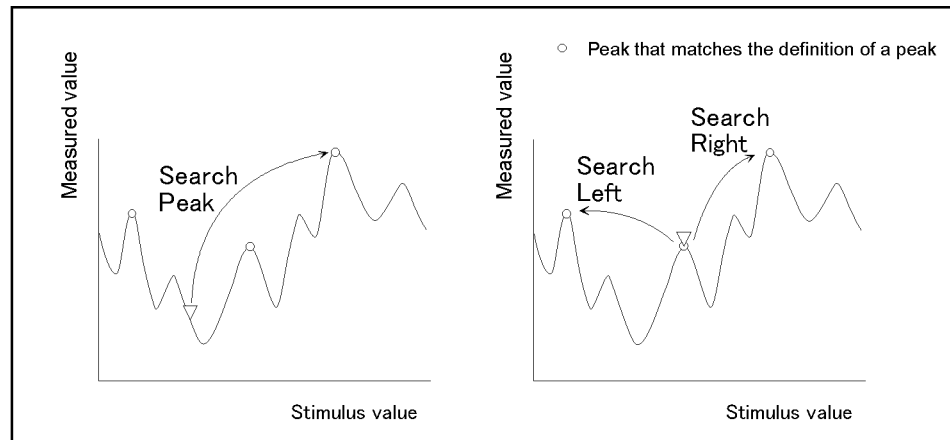

Executing a Peak Search

Step 1. Following Step 1 to Step 4 in “Reading values on the trace” on page 253, activate the marker you are using for the peak search.

Step 2. Press **Marker Search**.

Step 3. Press **Peak**.

Step 4. Press **Peak Excursion** and enter the lower limit for the peak excursion value.

This sets the peak search to be executed based on the definitions of the newly set lower limit for the peak excursion value and the currently set peak polarity.

Step 5. Press **Peak Polarity**.

Step 6. Select a peak polarity.

Softkey	Function
Positive	Selects Positive as peak polarity
Negative	Selects Negative as peak polarity
Both	Selects Both Positive and Negative as peak polarity

This sets the peak search to be executed based on the definitions of the currently set lower limit for the peak excursion value and the newly set peak polarity.

Step 7. Press the corresponding softkey to move the marker to the peak.

Softkey	Function
Search Peak	Executes peak search
Search Left	Executes left search
Search Right	Executes right search

NOTE

When the data format is in Smith chart or polar format, execute the search for the main response value of the two marker response values.

Determining the Bandwidth of the Trace (Bandwidth Search)

The bandwidth search is a function for determining the bandwidth of the trace, center frequency, cut-off points (on the higher frequency and the lower frequency sides), Q, and insertion loss, based on the position of the active marker. The definitions of the parameters determined through the bandwidth search are shown in Figure 6-13 and Table 6-2. The user specifies the defined bandwidth value as shown in Figure 6-13.

Figure 6-13

Bandwidth parameters

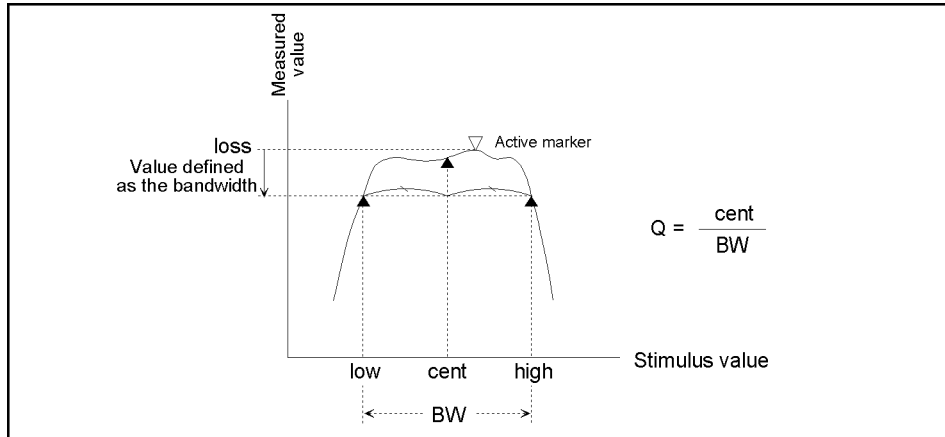

e5070aue054

Table 6-2

Definitions of Bandwidth Parameters

Bandwidth Parameter	Definition
Insertion loss (loss)	The measured value of the position of the active marker at the time the bandwidth search is executed.
Lower frequency cut-off point (low)	Lowest frequency of two measurement points, both separated by the defined bandwidth value from the active marker position.
Higher frequency cut-off point (high)	Highest frequency of two measurement points, both separated by the defined bandwidth value from the active marker position.
Center frequency (cent)	Frequency at the midpoint between the lower frequency cut-off and higher frequency cut-off points. ($\frac{high + low}{2}$).
Bandwidth (BW)	The difference in frequency between the higher frequency cut-off and lower frequency cut-off points ($high - low$).
Q	Value obtained by dividing the center frequency by the bandwidth ($\frac{cent}{BW}$).

Executing a Bandwidth Search

Step 1. Place the active marker at the desired point on the trace on which the bandwidth search is

Determining the Bandwidth of the Trace (Bandwidth Search)

executed. The response value of this active marker itself is the insertion loss in the bandwidth search (**loss**).

- Step 2.** Press **Marker Search**.
- Step 3.** Press **Bandwidth Value** and enter the defined bandwidth value in the entry area that appears.
- Step 4.** Press **Bandwidth** to turn on the bandwidth search. In the upper left of the trace display, six bandwidth parameters are displayed (Figure 6-14).

Figure 6-14

Bandwidth search results (defined bandwidth = -3 dB)

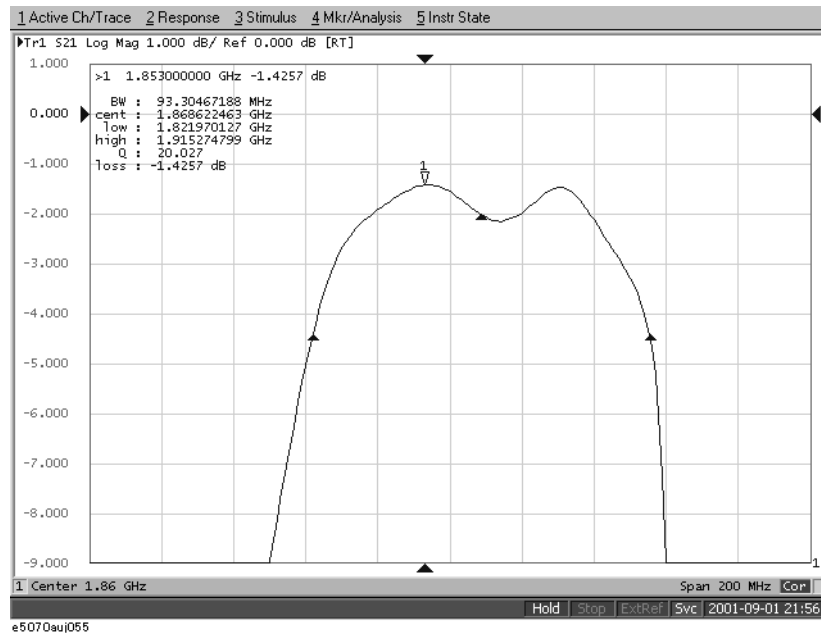

Determining the Mean, Standard Deviation, and p-p of the Trace

You can easily determine the statistics data for a trace (mean, standard deviation, and peak-to-peak). Figure 6-15 and Table 6-3 show the definitions for the statistics data elements.

Figure 6-15

Parameters used for calculating statistics data

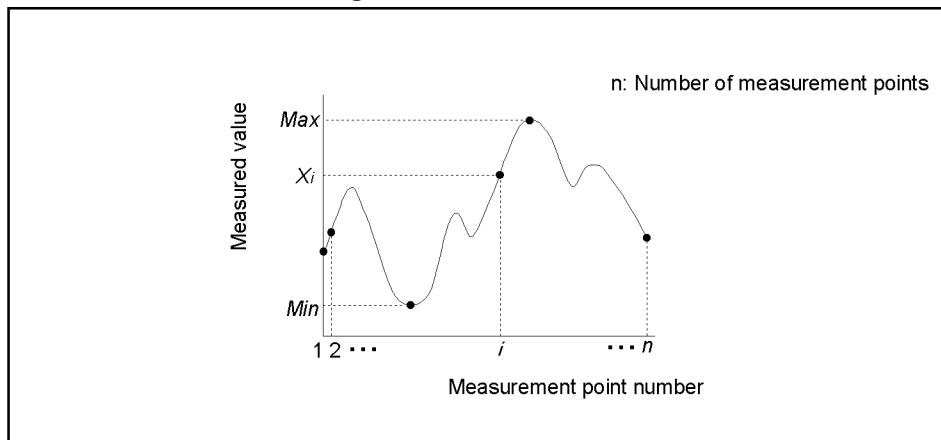

e5070aue053

Table 6-3

Definitions of Statistics Data

Statistics data element	Definition
Mean (mean)	$\frac{\sum_{i=1}^n x_i}{n}$ (n: number of points; x_i : measured value at the i-th measurement point)
Standard deviation (s. dev)	$\sqrt{\frac{\sum_{i=1}^n (x_i - \text{mean})^2}{n - 1}}$ (n: number of points; x_i : measured value at the i-th measurement point; mean: Mean)
Peak-to-peak (p - p)	$\text{Max} - \text{Min}$ (Max: greatest measured value; Min: smallest measured value)

Displaying Statistics Data

Step 1. Press **Channel Next** (or **Channel Prev**) and **Trace Next** (or **Trace Prev**) to activate the trace for which statistics data is required.

Step 2. Press **Marker Fctn**.

Step 3. Press **Statistics** to turn on the display of statistics data.

Comparing Traces/Performing Data Math

Each of the traces for which measured data is displayed is provided with an additional trace, called a memory trace, that temporarily stores measured data. You can use the memory trace to compare traces on the screen or to perform complex data math between the memory trace and measured data.

The following data math operations are available:

Data / Memory	Divides the measured data by the data in the memory trace. This function can be used to evaluate the ratio of two traces (e.g., evaluating gain or attenuation).
Data * Memory	Multiplies the measured data by a memory trace.
Data – Memory	Subtracts a memory trace from the measured data. This function can be used, for example, to subtract a vector error that has been measured and stored (e.g., directivity) from data subsequently measured on a device.
Data + Memory	Adds the measured data and the data in the memory trace.

Performing Data Math Operations

- Step 1.** Press **Channel Next** (or **Channel Prev**) and **Trace Next** (or **Trace Prev**) to activate the trace to be stored in memory.
- Step 2.** Press **Display**.
- Step 3.** Press **Data** → **Mem** to store the measured data in memory.
- Step 4.** Press **Data Math**.
- Step 5.** Select the data math operation to perform.

Softkey	Function
OFF	Turns off data math functions (Do not perform data math)
Data / Mem	Divides measured data by memory trace and stores result in data trace
Data * Mem	Multiplies data trace by memory trace and stores result in data trace
Data – Mem	Subtracts memory trace from data trace and stores result in data trace
Data + Mem	Adds data trace and memory trace and stores result in data trace

- Step 6.** Press **Display**.
- Step 7.** Select the type of data to display on the screen.

Softkey	Function
Data	Displays only data trace on the screen
Mem	Displays only memory trace stored by Data → Mem operation on the screen

Softkey	Function
Data & Mem	Displays data trace and memory trace on the screen. You can now easily compare the data trace and memory trace on the screen.
Off	Trace is not displayed

Step 8. Send the trigger to make measurements.

Performing Parameter Conversion of Measurement Results

You can use the parameter conversion function to convert the measurement results of the S-parameter (S_{ab}) to the following parameters.

- ❑ Equivalent impedance (Z_r) and equivalent admittance (Y_r) in reflection measurement

$$Z_r = Z_{0a} \times \frac{1 + S_{ab}}{1 - S_{ab}}, Y_r = \frac{1}{Z_r}$$

- ❑ Equivalent impedance (Z_t) and equivalent admittance (Y_t) in transmission measurement

$$Z_t = \frac{2 \times \sqrt{Z_{0a} \times Z_{0b}}}{S_{ab}} - (Z_{0a} + Z_{0b}), Y_t = \frac{1}{Z_t}$$

- ❑ Inverse S-parameter ($\frac{1}{S_{ab}}$)

where:

Z_{0a} Characteristic impedance of port a^{*1}

Z_{0b} Characteristic impedance of port b^{*1}

Operational Procedure

ON/OFF

- Step 1.** Press **Channel Next** or **Channel Prev** to activate a channel on which you want to use the marker.
- Step 2.** Press **Trace Next** or **Trace Prev** to activate a trace on which you want to use the marker.
- Step 3.** Press **Analysis**.
- Step 4.** Press **Conversion**.
- Step 5.** Press **Conversion** to turn ON the conversion function.

*1. When the fixture simulator function is ON and the port impedance function is ON, the value set in the port impedance conversion is used. In other cases, the system Z0 (preset value: 50 Ω) is used.

Selecting Conversion Target Parameter

- Step 1.** Press **Channel Next** or **Channel Prev** to activate the channel on which you want to use the marker.
- Step 2.** Press **Trace Next** or **Trace Prev** to activate the trace on which you want to use the marker.
- Step 3.** Press **Analysis**.
- Step 4.** Press **Conversion**.
- Step 5.** Press **Function**.
- Step 6.** Press the softkey corresponding to the parameter to which you want to convert the result.

When the conversion function is ON, the selected parameter is displayed in “5-5. Trace Status Area” on page 48.

Using the Equation Editor

Measurement data (corrected data) can be calculated by creating a equation using the equation editor.

The equation editor can create a equation label, too. The created equation label is displayed on the measurement parameter area of the screen. For details, refer to “Entering the equation label” on page 279

The following describes how to use the equation editor.

Procedure to start the equation editor

- Step 1.** Press **Channel Next** or **Channel Prev** to activate the channel for which you want to use the equation editor.
- Step 2.** Press **Trace Next** or **Trace Prev** to activate the trace for which you want to use the equation editor.
- Step 3.** Press **Display** .
- Step 4.** Press **Equation Editor...**

Procedure to use the equation editor

The following screen appears when starting the equation editor.

Figure 6-16

Equation editor

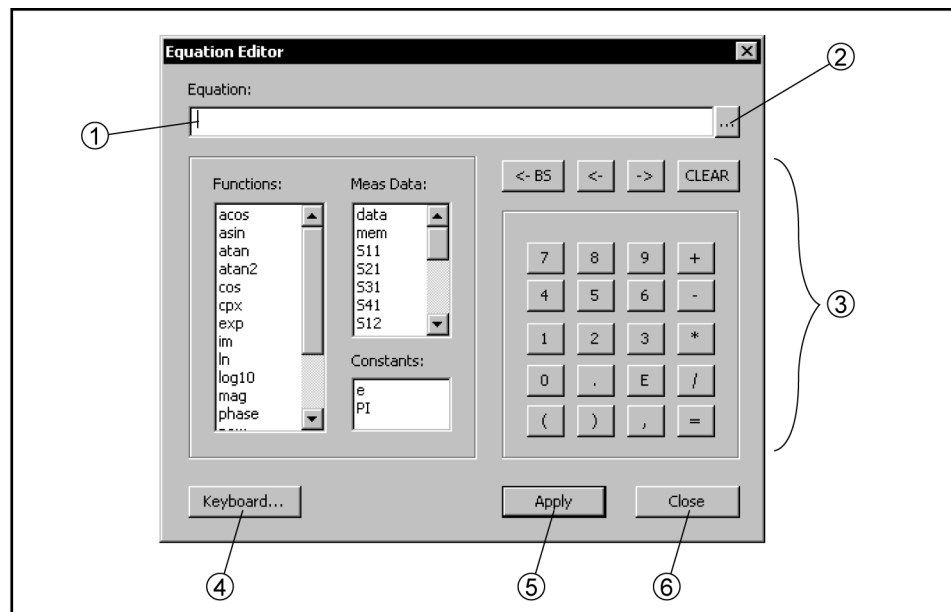

e5070buj10001

Data Analysis

Using the Equation Editor

1. A field to enter an equation and equation label

An equation and equation label are input here. An equation label can be omitted.

2. Display the history of equations

Registered 10 equations are displayed in order of newest first. You can reset the equation by selecting an equation displayed and then pressing the OK button.

NOTE

Turning off the E5070B/E5071B clears the registered equation history, while preset does not clear it.

3. Enter a equation

Enter an equation using functions, reference data, constants, numeric keys, and calculation keys. Characters are not case-sensitive.

NOTE

If you enter a parameter in the equation which is not measured (for example, you input S22 although only S11 has been measured), the correct calibration result cannot be displayed. In this case, "Equ!" is displayed in the trace status area on the screen.

NOTE

Mutual conversion is automatically made for functions, "scalar" and "complex,"

- $\text{Scalar}(x) \rightarrow \text{complex}(x, 0)$
 - $\text{Complex}(x, y) \rightarrow \text{scalar}(x)$
-

4. Enter letters

Enter letters such as an equation label by displaying the keyboard. You can also input letters directly from the keyboard without using this button.

5. Apply button

The entered equation and equation label are updated.

6. Close button

Close the equation editor.

Enabling/Disabling the equation editor

The following procedure describes how to enable/disable the equation entered using the equation editor.

- Step 1.** Press **Channel Next** or **Channel Prev** to activate the channel for which you want to use the equation editor.
- Step 2.** Press **Trace Next** or **Trace Prev** to activate the trace for which you want to use the equation editor.
- Step 3.** Press **Display**.
- Step 4.** Press **Equation**.

Softkey	Function
ON	Enables the equation editor.
OFF	Disables the equation editor.

Entering the equation label

You can enter an equation label using the equation editor. After inputting, the measurement parameter of the active trace is displayed on the screen as the equation label (Figure 6-17).

By entering the equation label and “=” prior to the equation, it is recognized as the equation label.

For the procedure to start the equation editor, refer to “Procedure to start the equation editor” on page 277.

NOTE A space is not available for the equation label.

The following figure is the example of the equation label, “myTr”.

Figure 6-17

Entering the equation label

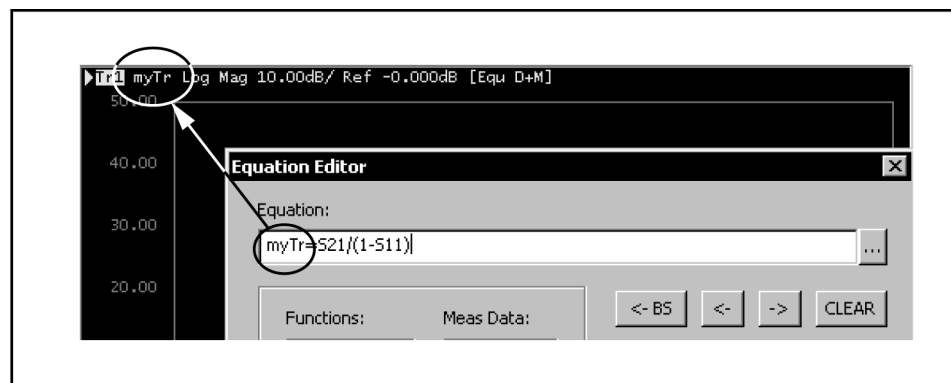

e5070buj10002

7**Fixture Simulator**

This chapter explains how to use the fixture simulator functions of the Agilent E5070B/E5071B.

Overview of Fixture Simulator

The fixture simulator is a function that uses software in the E5070B/E5071B to simulate various measurement conditions based on the measurement results. The six functions are as follows.

- Network de-embedding
- Port reference impedance conversion
- Matching circuit embedding
- 4-port network embedding/de-embedding
- Balance-unbalance conversion^{*1}
- Differential/Common port reference impedance conversion^{*1}
- Differential matching circuit embedding^{*1}

Figure 7-1 shows the data processing flow diagram of the fixture simulator.

Figure 7-1 Data processing flow diagram of fixture simulator

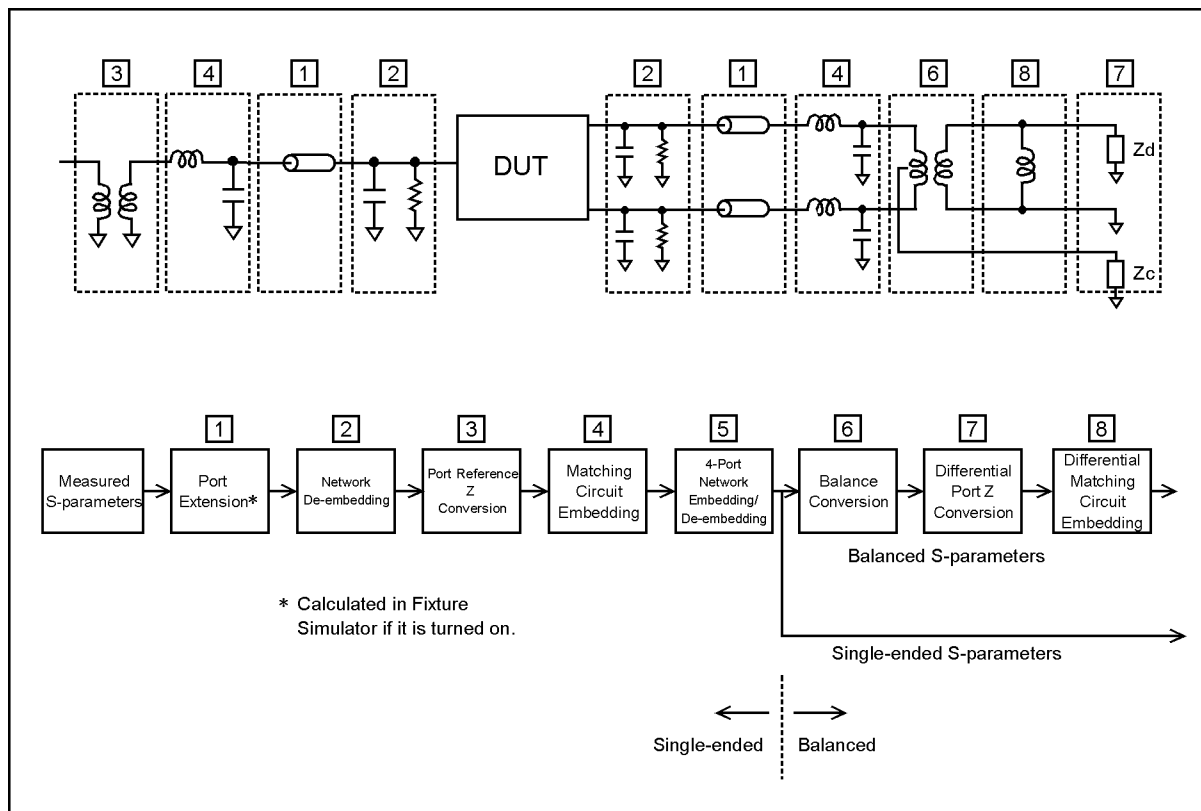

e5070bue076

*1. Option 313, 314, 413, or 414 only.

Port extension is an independent function from the fixture simulator, but if the fixture simulator function is on, data processing is automatically executed as a function of the fixture simulator to improve the data processing efficiency. (Measurement result is the same as when the fixture simulator is turned off.) Port extension moves the calibration reference location by setting an electrical delay for a single-ended port. Port extension can eliminate only electrical delay (phase shift) for each single-ended port. Loss or mismatch cannot be eliminated by this function.

Functions for single-ended (unbalanced) port

The following three functions are applied to single-ended ports (unbalanced ports). Balance-unbalance conversion can additionally be applied to single-ended ports.

Network de-embedding

A function that uses software to remove an arbitrary network ($50\ \Omega$ system) defined by a two-port Touchstone data file from each test port (single-ended) and to extend the calibration plane. This makes it possible to remove networks that create error elements between the calibration plane and the DUT, thereby enabling a more realistic evaluation of the DUT.

For the setup procedure of the network de-embedding function, see “Extending the Calibration Plane Using Network De-embedding” on page 285.

Port reference impedance conversion

A function that uses software to convert an S-parameter measured with a $50\ \Omega$ port reference impedance into a value measured with an arbitrary impedance.

For the setup procedure of port reference impedance conversion, see “Converting the Port Impedance of the Measurement Result” on page 286.

Matching circuit embedding

A function for converting an original measurement result into a characteristic determined under the condition of inserting a matching circuit between the DUT and the test port (single-ended). The matching circuit to be inserted is either selected from the five predetermined circuit models or provided by a designated arbitrary circuit defined in a two-port Touchstone file.

For the setup procedure used for matching circuit embedding, see “Determining Characteristics After Adding a Matching Circuit” on page 287.

4-port network embedding/de-embedding

This is a feature to embed (in terms of numerical calculation) your desired network that you have defined in a 4-port Touchstone data file into measurement results or to de-embed it from them.

For information on how to operate this function, refer to “Obtaining Characteristics After Embedding/De-embedding 4-port Network” on page 290.

Balance-unbalance conversion (option 313, 314, 413, or 414)

A function that uses software to convert the measurement results in an unbalanced DUT state, which are obtained by connecting the DUT to the test port of the E5070B/E5071B, into measurement results in a balanced state. Two test ports of the E5070B/E5071B are connected to one balanced port of the DUT.

For the setup procedure used for balance-unbalance conversion, see “Evaluating Balanced Devices (balance-unbalance conversion function)” on page 293.

Functions for balanced port (option 313, 314, 413, or 414)

The following two functions are applied to a balanced (differential) port converted by balance-unbalance conversion.

Differential port impedance conversion

A function for converting the differential mode port impedance of a balanced port after an balance-unbalance conversion. Balance-unbalance conversion automatically converts the differential mode port impedance at the balanced port into $2Z_0$ and the common mode port impedance into $Z_0/2$, compared with the two pre-conversion port impedances of Z_0 . Differential port impedance conversion further converts a differential port impedance after balance-unbalance conversion into an arbitrary port impedance.

For the setup procedure used for differential port impedance conversion, see “Converting Reference Impedance of Balanced Port” on page 300.

Differential matching circuit embedding

A function for converting the measurement results obtained from balance-unbalance conversion into a characteristic under the condition of inserting a matching circuit in the balanced port.

For setup procedure of differential matching circuit embedding, see “Determining the Characteristics that Result from Adding a Matching Circuit to a Differential Port” on page 303.

Extending the Calibration Plane Using Network De-embedding

Network de-embedding is a function for performing measurements, test port by test port, by removing the characteristics of an arbitrary network defined by a Touchstone data file. By removing the characteristics of the cable, test fixtures, etc. between the actual calibration plane and the DUT, the calibration plane can be correspondingly extended. The network de-embedding function can be used together with the port extension function (see Figure 7-2).

Figure 7-2

Port extension and calibration plane extension using network de-embedding

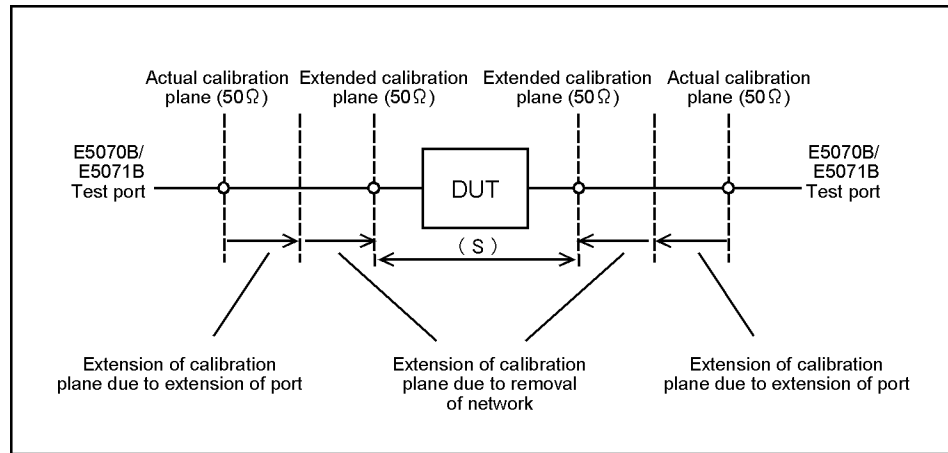

e5070bue074

Using the Network De-embedding Function

- Step 1.** Prepare a two-port Touchstone data file (.s2p format) corresponding to the network to be removed.
- Step 2.** Press **Analysis** - **Fixture Simulator** - **De-Embedding**.
- Step 3.** Press **Select Port**.
- Step 4.** Press **1, 2, 3,** or **4** to select the test port from which the network de-embedding is performed.
- Step 5.** Press **User File**.
- Step 6.** Using the dialog box that appears, select the Touchstone data file defining the characteristics of the network to be removed. Once the file is selected, the selection of **Select Type** automatically changes to **User**. To cancel a user-defined file that has been set up, press **Select Type - None**.
- Step 7.** Repeat Step 3 to Step 6 to set up the Touchstone data file for each port from which a network is to be removed.
- Step 8.** Press **De-Embedding** to turn the network de-embedding function **ON**.
- Step 9.** Press **Return**.
- Step 10.** If **Fixture Simulator** is **OFF**, press the key again to turn it **ON**.

Converting the Port Impedance of the Measurement Result

The measured value obtained by using a port impedance of $50\ \Omega$ can be converted into a measured value at an arbitrary port impedance.

Figure 7-3

Port impedance conversion function

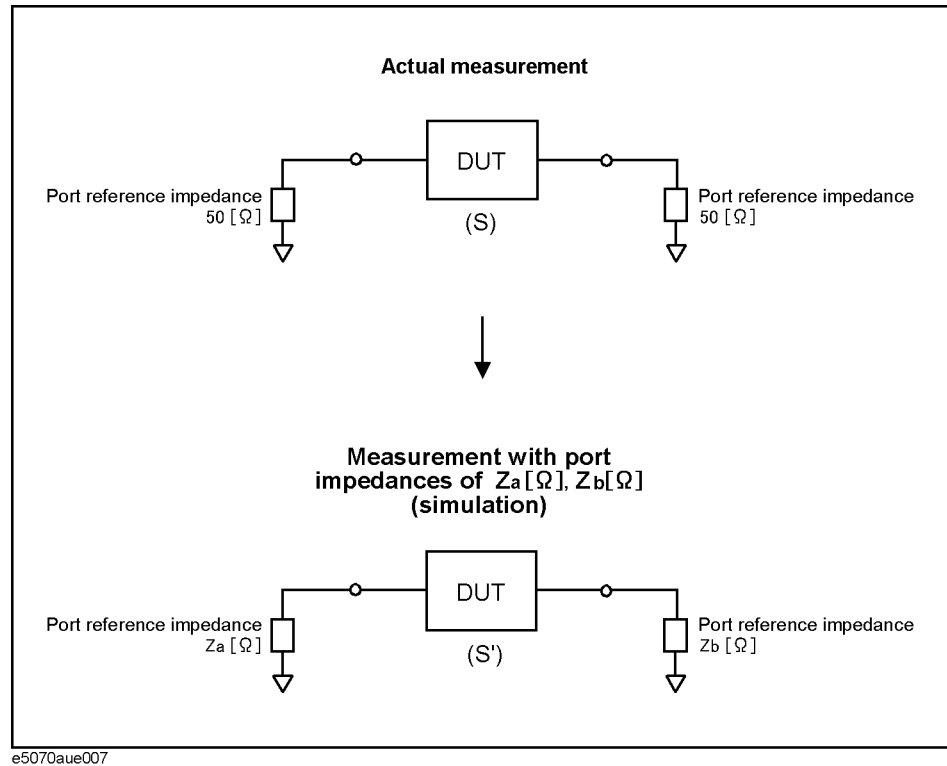

Converting the Port Impedance

Step 1. Press **Analysis** - **Fixture Simulator** - **Port Z Conversion**.

Step 2. Specify the port reference impedance for the required port.

- Select **Port 1 Z0 Real**, **Port 2 Z0 Real**, **Port 3 Z0 Real**, or **Port 4 Z0 Real** to set the port reference impedance in “Real” format.
- Select **Port 1 Z0 Real** and **Port 1 Z0 Imag**, **Port 2 Z0 Real** and **Port 2 Z0 Imag**, **Port 3 Z0 Real** and **Port 3 Z0 Imag**, or **Port 4 Z0 Real** and **Port 4 Z0 Imag** to set the port reference impedance in “Complex” format.

Step 3. Press **Port Z Conversion** to change the port impedance conversion function to the **ON** state.

Step 4. Press **Return**.

Step 5. If **Fixture Simulator** is **OFF**, press the key again to turn it **ON**.

Determining Characteristics After Adding a Matching Circuit

Using the matching circuit embedding function, you can easily obtain the resulting characteristics after adding a matching circuit for each test port (Figure 7-4).

Figure 7-4

Matching circuit function

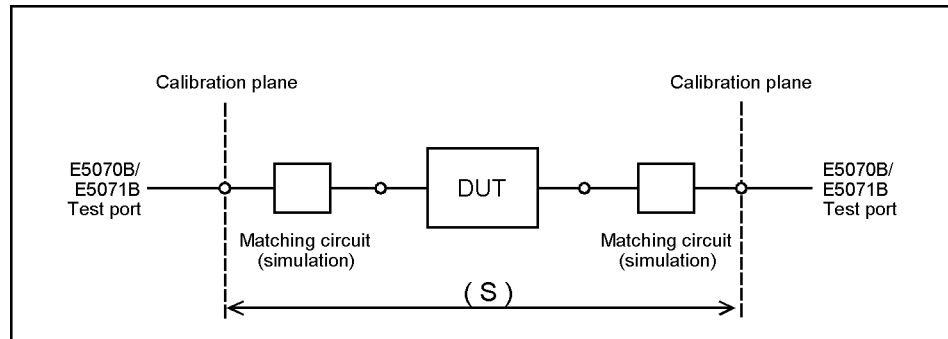

e5070bue067

Define the matching circuit to be added by one of the following methods:

- Select one of the five predetermined circuit models and specify the values for the elements in the circuit model.
- Use a user file (in two-port Touchstone data format) that defines the matching circuit to be added.

The circuit models used for defining matching circuits are shown in Figure 7-5.

Using the Matching Circuit Function

- Step 1.** Press **Analysis** - **Fixture Simulator** - **Port Matching**.
- Step 2.** Press **Select Port**.
- Step 3.** Press **1**, **2**, **3**, or **4** to select the port to which a matching circuit is to be added.
- Step 4.** To add a matching circuit defined in a user file, execute the following operations:
 - a. Press **User File**.
 - b. In the dialog box that appears, select the two-port Touchstone data file (.s2p format) for the matching circuit to be added.

Once a user file is specified, the selection of **Select Circuit** automatically changes to **User**. In this case, you do not need to execute Step 5 and Step 6.

Figure 7-5 Circuit models for defining matching circuits

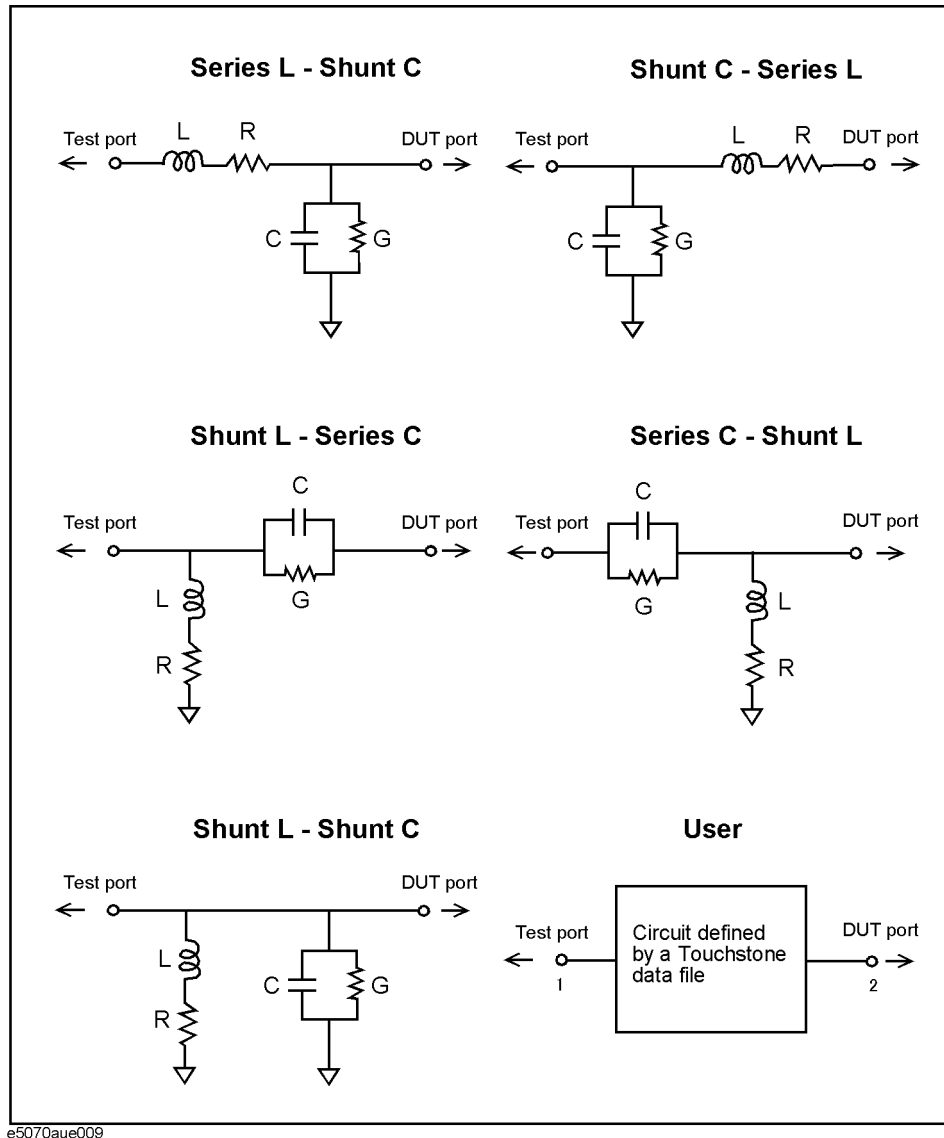

NOTE

In the 2-port matching circuit embedding or the 2-port network de-embedding feature, if the normalized impedance value specified in the user file (2-port Touchstone data file) is different from the port reference impedance setting value of the analyzer, it is automatically converted to adapt to the analyzer setting.

When a 2-port Touchstone data file is read in, data for up to 3202 frequency points are read in using interpolation according to the measurement frequency point setting of the analyzer. If the number of frequency points in the file is greater than 3202, excess data are ignored.

For a network defined in the user file, it is assumed that port 1 is connected to the test port and port 2 is connected to the DUT.

Step 5. Press **Select Circuit**.

Step 6. Select a matching circuit model (Figure 7-5).

Softkey	Function
None	No matching circuit is added.
Series L - Shunt C	Selects a circuit model consisting of a series inductor and a shunt capacitor
Shunt C - Series L	Selects a circuit model consisting of a shunt capacitor and a series inductor
Shunt L - Series C	Selects a circuit model consisting of a shunt inductor and a series capacitor
Series C - Shunt L	Selects a circuit model consisting of a series capacitor and a shunt inductor
Shunt L - Shunt C	Selects a circuit model consisting of a shunt inductor and a shunt capacitor
User	Selects the circuit model defined in the user file imported by performing Step 4

Step 7. Specify the values of the elements in the selected circuit model.

Softkey	Function
C	Specifies capacitance [F]
G	Specifies conductance [S]
L	Specifies inductance [H]
R	Specifies resistance [Ω]

NOTE

When either of the two components of Series-C, "C" and "G", is set to 0, the component is defined as "Open"; when both components are set to 0, they are defined as "Short."

When either of the two components of Shunt-L, "L" and "R", is set to 0, the component is defined as "Short"; when both components are set to 0, they are defined as "Open."

Step 8. Repeat Step 3 to Step 7 to set up the matching circuit for each port used.

Step 9. Press **Port Matching** to turn the matching circuit function **ON**.

Step 10. Press **Return**.

Step 11. If **Fixture Simulator** is **OFF**, press the key again to turn it **ON**.

Obtaining Characteristics After Embedding/De-embedding 4-port Network

The 4-port network embedding/de-embedding feature allows you to add (embed) or remove (de-embed) data of your desired 4-port network defined in a 4-port Touchstone data file to or from measurement values through software-based processing. The embedding/de-embedding supports three types of connection as shown in Figure 7-6.

NOTE This function is available with firmware version 3.50 or greater.

Figure 7-6 Connection that enables embedding/de-embedding network (4-port touchstone data)

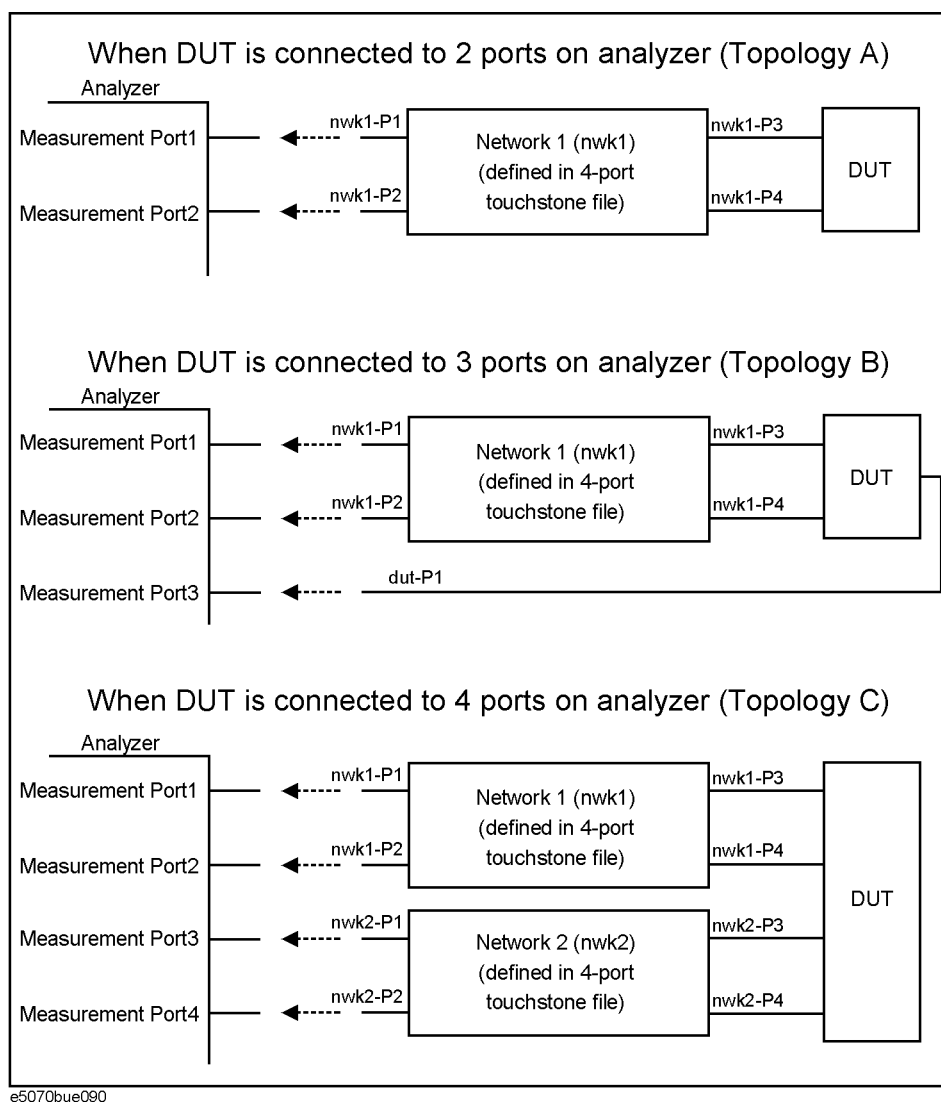

Operational Procedure

- Step 1.** Prepare a 4-port touchstone data file (.s4p format) corresponding to a network you want to embed/de-embed.
- Step 2.** Press **Analysis** - **Fixture Simulator - De-Embedding S4P**.
- Step 3.** Press **Topology - Select Topology** and select a network connection type (topology) from A, B, or C (Figure 7-6).
- Step 4.** Press **Ports** to select measurement port numbers of the analyzer to which you want to connect ports 1 and 2 of the 4-port network.

For topology **A**: Select measurement port numbers of the analyzer to which you want to connect nwk1-P1 and nwk1-P2 in Figure 7-6. For example, when you connect nwk1-P1 and nwk1-P2 to measurement ports 1 and 2, respectively, as shown in Figure 7-6, specify Ports =“1-2”.

For topology **B**: Select measurement port numbers of the analyzer to which you want to connect nwk1-P1, nwk1-P2, and dut-P1 in Figure 7-6. For example, when you connect nwk1-P1, nwk1-P2, and dut-P1 to measurement ports 1, 2, and 3, respectively, as shown in Figure 7-6, specify Ports=“1-2-3”.

For topology **C**: Select measurement port numbers of the analyzer to which you want to connect nwk1-P1, nwk1-P2, nwk2-P1, and nwk2-P2 in Figure 7-6. For example, when you connect nwk1-P1, nwk1-P2, nwk2-P1, and nwk2-P2 to measurement ports 1, 2, 3, and 4, respectively, as shown in Figure 7-6, specify Ports=“1-2-3-4”.

NOTE

When defined in the 4-port Touchstone data file, a 4-port network assumes that ports 1 and 2 are connected to the analyzer and that ports 3 and 4 are connected to the DUT.

For measuring a 4-port DUT with a 4-port network embed/de-embed only on one side, select topology C instead of A, set embedding/de-embedding on the desired side, and specify no processing (None) on the other side.*¹

For measuring a 3-port DUT with a 4-port network embed/de-embed on one side and a 2-port network on the other side, select topology B instead of A, embed/de-embed a 4-port network on one side, and embed/de-embed a 2-port network on the other side using the 2-port matching circuit embedding feature or the 2-port network de-embedding feature.*¹

- Step 5.** Press **User File (nwk1)** and select a 4-port Touchstone data file you want to use for network 1.

*1. Selecting topology A will result in unexpected measurement.

Step 6. Press **Type (nwk1)** and select a processing type for network 1.

Softkey	Function
None	Specifies no-processing (equivalent to turning off the feature)
Embed	Selects embedding
De-Embed	Selects de-embedding

NOTE

If you have not specified an appropriate file in Step 5, you cannot select embedding (**Embed**) or de-embedding (**De-embed**). If you have not specified an appropriate file and you try to select embedding/de-embedding, an error occurs and no-processing (**None**) is automatically selected.

Step 7. If you have selected topology C, also make the necessary settings for network 2 (**nwk2**).

Step 8. Press **De-Embedding S4P** to turn **ON** the 4-port network embedding/de-embedding feature.

Step 9. Press **Return**.

Step 10. If **Fixture Simulator** is **OFF**, press the key to turn it **ON**.

NOTE

When the 4-port network embedding/de-embedding feature reads a 4-port Touchstone data file, it does not automatically convert the file's normalized impedance value to adapt to the port reference impedance setting value of the analyzer. If a 4-port Touchstone data file that has a different normalized impedance value than that of the port reference impedance setting value that is read in by the analyzer, correct measurement results will not be obtained. Therefore, when you create a 4-port Touchstone file, be sure that the normalized impedance value in the data file is the same as the port reference impedance value of the analyzer specified for actual measurement. When you create a 4-port Touchstone file using the VBA macro on the E5070B/E5071B, set the port reference impedance value to your desired value before executing the macro.

A Touchstone data file is defined for a single normalized impedance value. Thus, when reading in a Touchstone data file with the 4-port network embedding/de-embedding feature, be sure to specify the same port reference impedance value to every measurement port pair connected to the same 4-port network. Taking the topology C in Figure 7-6 for example, the port reference impedance of the analyzer measurement port pair of ports 1 and 2 and that of the measurement port pair of ports 3 and 4 must be set to the same value.

When a 4-port Touchstone data file is read in, data for up to 3202 frequency points are read in by using interpolation according to the measurement frequency point setting of the analyzer. If the number of frequency points in the file is greater than 3202, excess data are ignored.

Evaluating Balanced Devices (balance-unbalance conversion function)

The balance-unbalance conversion function simulates a measurement under a balanced state based on measurement results obtained in an unbalanced state (Figure 7-7). This function enables you to evaluate devices with balanced ports.

NOTE

Be sure to set the impedances of the two unbalanced ports equal to each other. For more details on setting up port impedance for unbalanced ports, refer to “Converting the Port Impedance of the Measurement Result” on page 286.

Figure 7-7

Balance-unbalance conversion

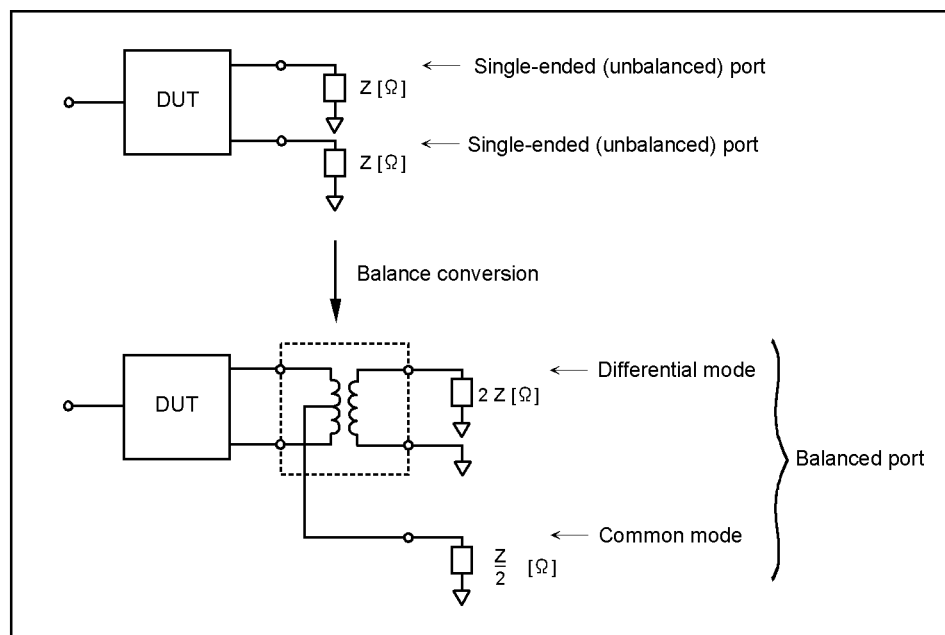

The types of devices that can be evaluated using the E5070B/E5071B are shown in Figure 7-8.

NOTE

To evaluate a balanced device, an E5070B/E5071B with at least three test ports (option 313, 314, 413, or 414) is required.

Figure 7-8

Types of balanced devices that can be evaluated with E5070B/E5071B

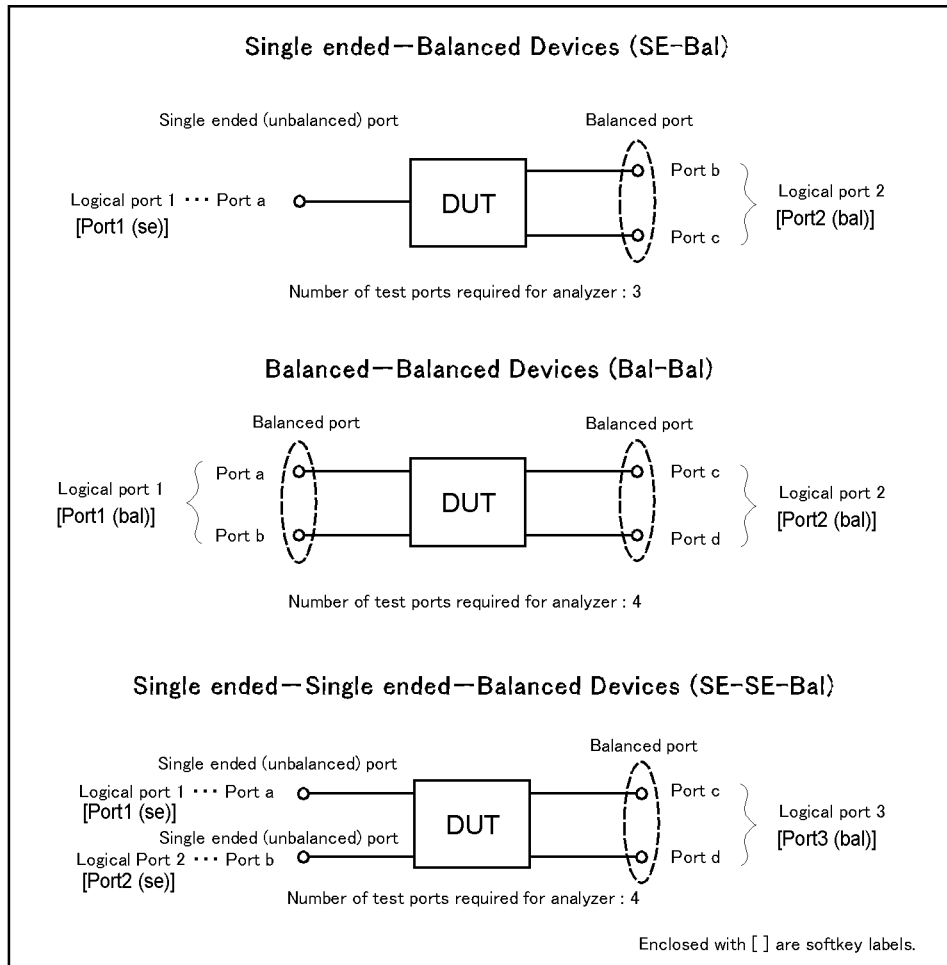

e5070aue010

In the terminology of the E5070B/E5071B, ports after the balance conversion are called logical ports (or DUT ports).

You can freely assign the test ports of the E5070B/E5071B to logical ports (ports a to d in Figure 7-8).

Evaluating Balanced Devices (balance-unbalance conversion function)

Measurement parameters of balanced devices

Turn on the balance-unbalance conversion function to measure the following parameters.

- Mixed mode S-parameter
- Imbalance parameter
- CMRR (Common Mode Rejection Ratio)

Mixed mode S-parameter

By turning on the balance-unbalance conversion function, you can obtain the S-parameter of the balanced port separately for two modes, the differential mode and the common mode. Figure 7-9 shows the notation of the S-parameter in balance measurement (mixed mode S-parameter).

Figure 7-9

Notation of mixed mode S-parameter

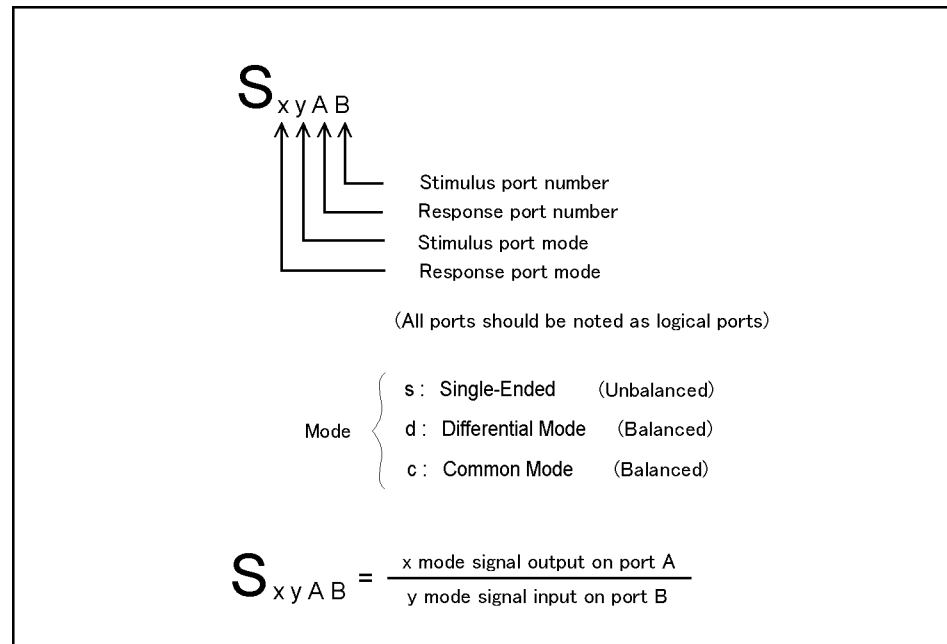

e5070aue023

Figure 7-10 to Figure 7-12 show the mixed mode S-parameter when measuring each balanced device.

Figure 7-10 Mixed mode S-parameter when measuring a single-ended - balanced device

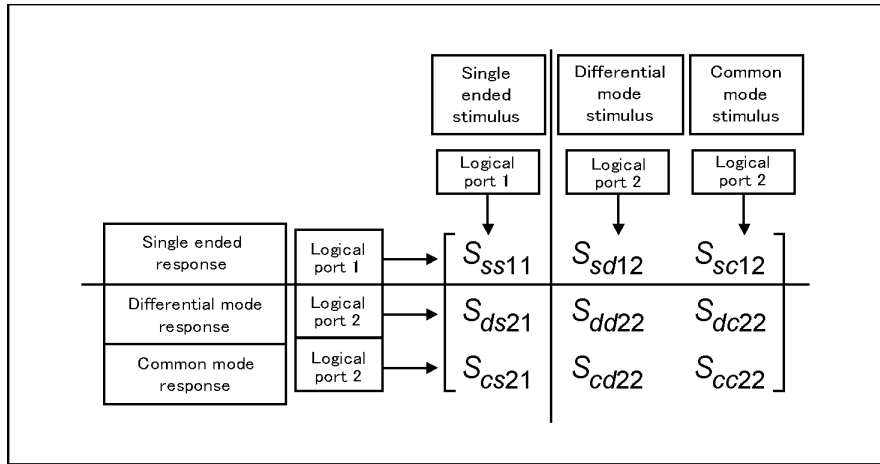

e5070aue184

Figure 7-11 Mixed mode S-parameter when measuring a balanced - balanced device

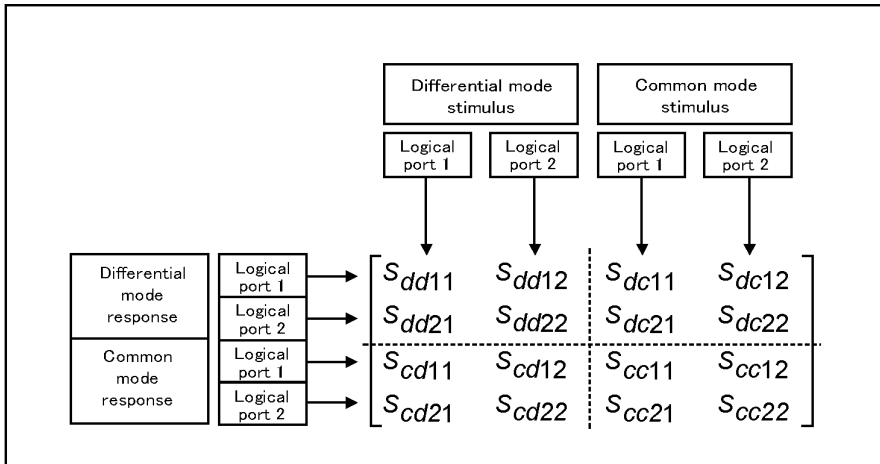

e5070aue183

Figure 7-12 Mixed mode S-parameter when measuring a single-ended - single-ended - balanced device

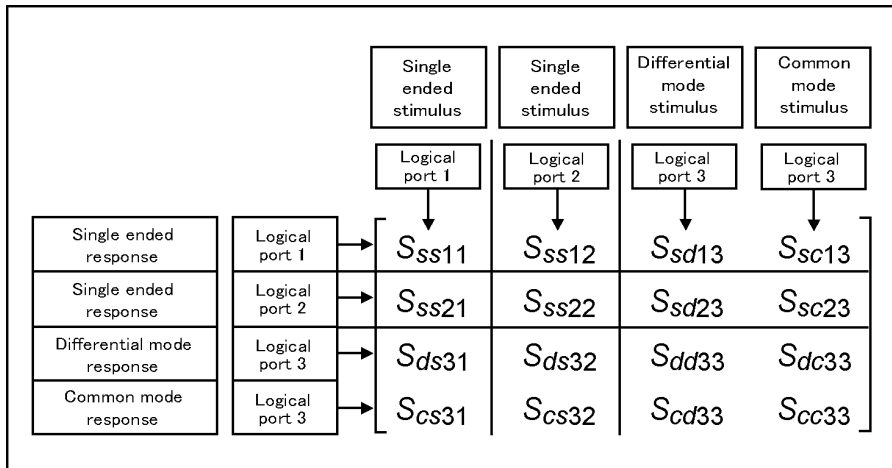

e5070aue185

Evaluating Balanced Devices (balance-unbalance conversion function)

Imbalance parameter

By turning on the balance-unbalance conversion function, you can select the imbalance parameter of the balanced port as the measurement parameter. Figure 7-13 to Figure 7-15 show the imbalance parameter you can select when measuring each balanced device.

Figure 7-13

Parameter when measuring a single-ended - balanced device (Imbalance)

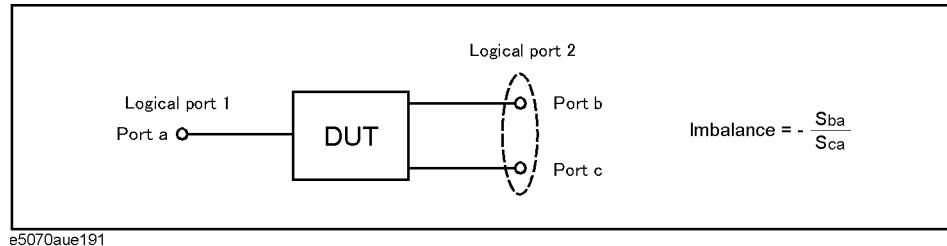

Figure 7-14

Parameter when measuring a balanced - balanced device (Imbalance1, Imbalance2)

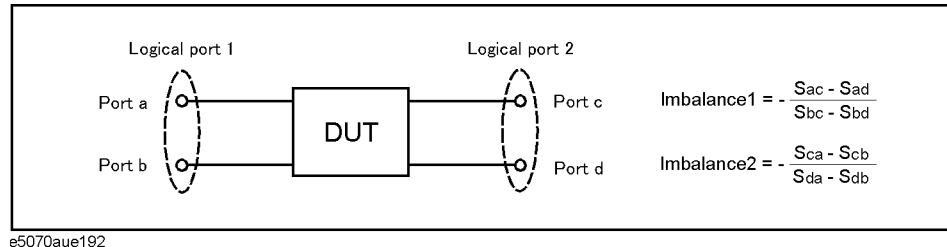
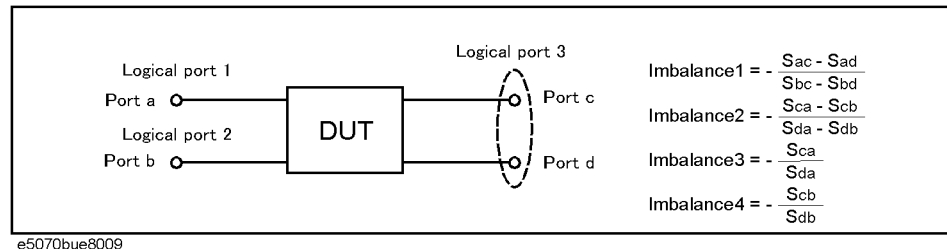

Figure 7-15

Parameter when measuring a single-ended - single-ended - balanced device (Imbalance1, Imbalance2, Imbalance3, Imbalance4)



CMRR (Common Mode Rejection Ratio)

By turning on the balance-unbalance conversion function, you can select CMRR (ratio between the transmission characteristic in the differential mode and that in the common mode) of the balanced port as the measurement parameter. The table below shows the CMRR parameter you can select when measuring each balanced device.

Single-ended - balanced device	$\frac{S_{ds21}}{S_{cs21}}$ and $\frac{S_{sd12}}{S_{sc12}}$
Balanced - balanced device	$\frac{S_{dd21}}{S_{cc21}}$
Single-ended - single-ended - balanced device	$\frac{S_{ds31}}{S_{cs31}}$ and $\frac{S_{ds32}}{S_{cs32}}$

Steps for Balance-Unbalance Conversion

NOTE

When using three test ports, perform a full three-port calibration on the test ports to be used. When using four test ports, perform a full four-port calibration.

Extend the calibration plane, if necessary, by using the port extension function or network de-embedding function. For more on the port extension and network de-embedding functions, see “Extending the Calibration Plane Using Network De-embedding” on page 285.

- Step 1.** Press **Analysis**.
- Step 2.** Press **Fixture Simulator**.
- Step 3.** Press **Topology**.
- Step 4.** Press **Device**.
- Step 5.** Select the balanced/unbalanced topology.

Softkey	Function
SE-Bal	Establishes port 1 on the DUT as an unbalanced port and port 2 as a balanced port
Bal-Bal	Establishes both port 1 and port 2 on the DUT as balanced ports
SE-SE-Bal	Establishes port 1 and port 2 on the DUT as unbalanced ports and port 3 as a balanced port

- Step 6.** Select each port on the analyzer to which a port on the DUT is connected.

- When you have selected **SE-Bal** in Step 5:

Softkey	Function
Port 1 (se)	Selects a port on the analyzer from among 1, 2, 3, and 4 for connection to logical 1 (Port a in Figure 7-8)
Port 2 (bal)	Selects two ports on the analyzer from among 1-2, 1-3, 1-4, 2-1, 2-3, 2-4, 3-1, 3-2, 3-4, 4-1, 4-2, and 4-3 for connection to logical port 2 (Port b and Port c in Figure 7-8)

- When you have selected **Bal-Bal** in Step 5:

Softkey	Function
Port 1 (bal)	Selects two ports on the analyzer from among 1-2, 1-3, 1-4, 2-1, 2-3, 2-4, 3-1, 3-2, 3-4, 4-1, 4-2, and 4-3 for connection to logical port 1 (Port a and Port b in Figure 7-8)
Port 2 (bal)	Selects two ports on the analyzer from among 1-2, 1-3, 1-4, 2-1, 2-3, 2-4, 3-1, 3-2, 3-4, 4-1, 4-2, and 4-3 for connection to logical port 2 (Port c and Port d in Figure 7-8)

- When you have selected **SE-SE-Bal** in Step 5:

Softkey	Function
Port 1 (se)	Selects a port on the analyzer from among 1, 2, 3, and 4 for connection to logical 1 (Port a in Figure 7-8)

Evaluating Balanced Devices (balance-unbalance conversion function)

Softkey	Function
Port 2 (se)	Selects a port on the analyzer from among 1, 2, 3, and 4 for connection to logical 2 (Port b in Figure 7-8)
Port 3 (bal)	Selects two ports on the analyzer from among 1-2, 1-3, 1-4, 2-1, 2-3, 2-4, 3-1, 3-2, 3-4, 4-1, 4-2, and 4-3 for connection to logical port 3 (Port c and Port d in Figure 7-8)

- Step 7.** Press **Return**.
- Step 8.** Press **BalUn** to turn on the balanced/unbalanced state conversion function.
- Step 9.** Press **Fixture Simulator** to turn on the fixture simulator function.

Steps for Measurement Parameter Setups

Performing balance-unbalance conversion enables you to make measurements with mixed mode S-parameters, imbalance parameters and CMRR. Parameters that can be used differ depending on the balance-unbalance topology specified in Step 5 in “Steps for Balance-Unbalance Conversion” on page 298.

- Step 1.** Press **Meas** (or **Analysis** - **Fixture Simulator** - **Measurement**).
- Step 2.** Select the measurement parameter.

Checking device type and port assignment

You can check the device type and the port assignment for the balance-unbalance conversion by displaying the balance measurement topology property as shown in Figure 7-16.

Figure 7-16

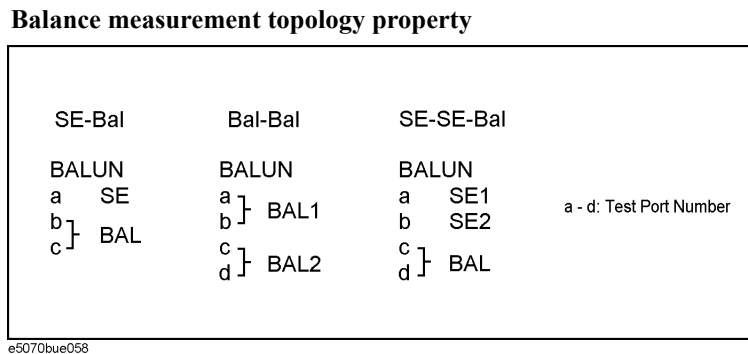

Procedure to Turn On/Off Balance Measurement Topology Property Display

Follow these steps to turn on/off the balance measurement topology property display.

- Step 1.** Press **Analysis**.
- Step 2.** Press **Fixture Simulator**.
- Step 3.** Press **Topology**.
- Step 4.** Press **Property**. Each press toggles between on/off.

Converting Reference Impedance of Balanced Port

By using the port impedance conversion function, you can specify the impedance of each test port. As a result of this conversion, the impedance of the balanced port in differential mode is set to a value twice as large as the impedance of the two unbalanced ports before conversion, and in common mode to a value one-half as large (Figure 7-17).

NOTE

Be sure to set the impedances of the two unbalanced ports equal to each other. For more details on setting up port impedance for unbalanced ports, refer to “Converting the Port Impedance of the Measurement Result” on page 286.

Figure 7-17

Port impedance after a balance-unbalance conversion

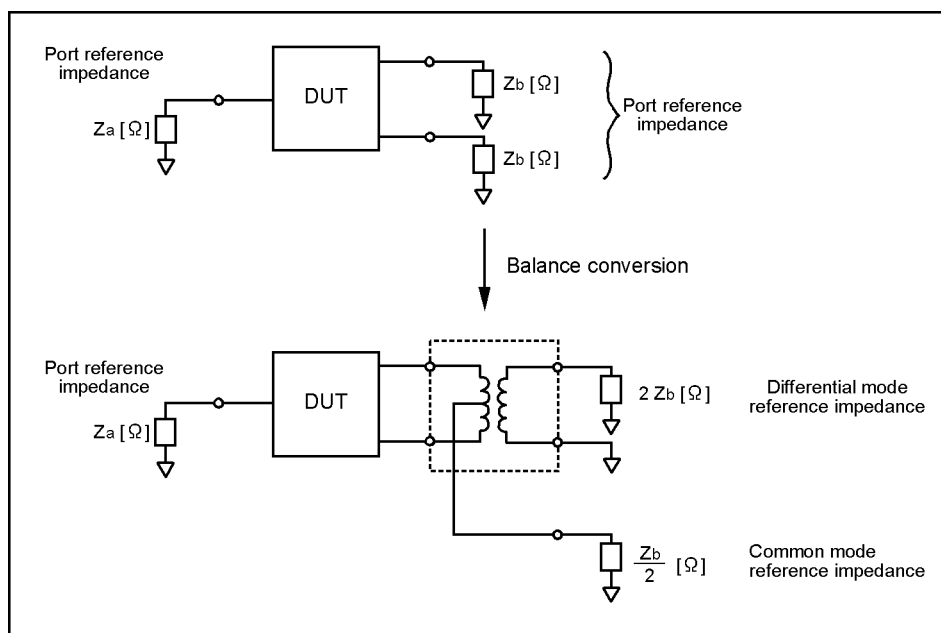

As described above, the impedance of the balanced port is automatically specified as the result of specifying the impedance of the two unbalanced ports prior to balance-unbalance conversion. However, the port impedance can be changed to an arbitrary value by using the differential port impedance conversion function and the common port impedance conversion function.

Converting port reference impedance in differential mode

If you turn on the differential port impedance conversion function, the port reference impedance in the differential mode is converted to an arbitrary value specified with this function instead of the value in Figure 7-17.

Procedure to Turn On/Off Differential Port Reference Impedance Conversion Function

- Step 1.** - Press **Fixture Simulator - Diff Z Conversion**.
- Step 2.** Press **Diff Z Conversion** to set the differential impedance conversion function to **ON**.

You can only turn on or off Differential Port Impedance Conversion for all of the balanced ports together, not for each port individually. If you want to turn off only a specific port, set the reference impedance of the port to the value in Figure 7-17.

Procedure to Set Differential Port Reference Impedance

- Step 1.** - Press **Fixture Simulator - Diff Z Conversion**.
- Step 2.** Specify the port reference impedance in differential mode.
- Select the balanced port from **Port 1 (bal) Real**, **Port 2 (bal) Real**, or **Port 3 (bal) Real** to set the differential port reference impedance in “Real” format.
 - Select **Port 1 (bal) Real** and **Port 1 (bal) Imag**, **Port 2 (bal) Real** and **Port2 (bal) Imag**, or **Port 3 (bal) Real** and **Port 3 (bal) Imag** to set the differential port reference impedance in “Complex” format.

NOTE Ports 1, 2, and 3 refer to the logical ports 1, 2, and 3.

Converting port reference impedance in common mode

If you turn on the common port impedance conversion function, the port reference impedance in the common mode is converted to an arbitrary value specified with this function instead of the value in Figure 7-17.

Procedure to Turn On/Off Common Port Reference Impedance Conversion

- Step 1.** - Press **Fixture Simulator - Cmn Z Conversion**.
- Step 2.** Press **Cmn Z Conversion** to set the common port impedance conversion function to **ON**.

You can only turn on or off Common Port Impedance Conversion for all of the ports together, not for each port individually. If you want to turn off only a specific port, set the impedance of the port to the value in Figure 7-17.

Procedure to set common port reference impedance

- Step 1.** - Press **Fixture Simulator - Cmn Z Conversion**.
- Step 2.** Specify the port reference impedance in common mode.
- Select the balanced port from **Port 1 (bal) Real**, **Port 2 (bal) Real**, or **Port 3 (bal) Real**

Converting Reference Impedance of Balanced Port

to set the differential port reference impedance in “Real” format.

- Select **Port 1 (bal) Real** and **Port 1 (bal) Imag**, **Port 2 (bal) Real** and **Port2 (bal) Imag**, or **Port 3 (bal) Real** and **Port 3 (bal) Imag** to set the common port reference impedance in “Complex” format.

NOTE

Ports1, 2, and 3 refer to the logical ports 1, 2, and 3.

Determining the Characteristics that Result from Adding a Matching Circuit to a Differential Port

You can obtain the characteristics resulting from the pseudo addition of a balance matching circuit to a balanced port created by balance-unbalance conversion. By using the matching circuit function, you can obtain the characteristics resulting from the addition of an arbitrary matching circuit for each test port (Figure 7-18).

Figure 7-18

Balance matching circuit function

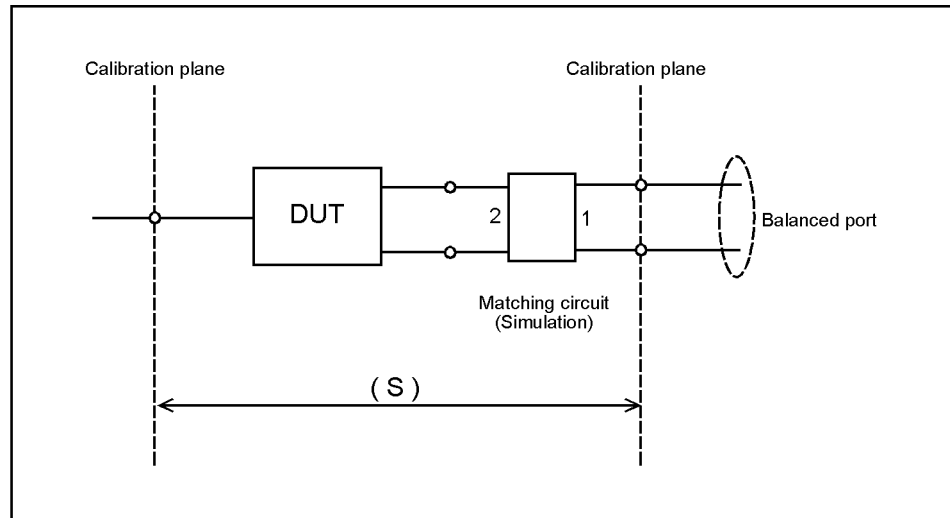

e5070aue012

Define the matching circuit to be added by one of the following methods:

- Use a predetermined circuit model and specify the values for the elements in the circuit model.
- Use a user file (in two-port Touchstone format) to define the matching circuit to be added.

Figure 7-19 shows the circuit models used in defining a balance matching circuit.

Figure 7-19

Circuit models used to define balance matching circuit

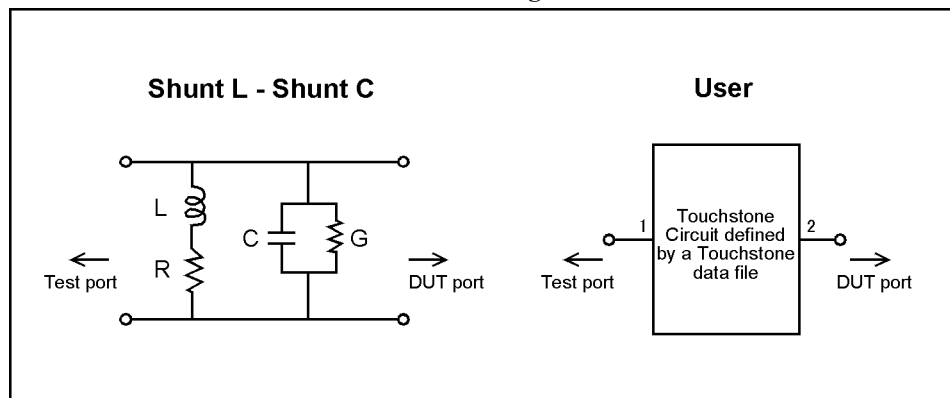

e5070aue15

Determining the Characteristics that Result from Adding a Matching Circuit to a Differential Port

NOTE For a network defined in a user file, it is assumed that port 1 is connected to the test port and port 2 is connected to the DUT.

The setup steps are shown below.

- Step 1.** Press **[Analysis]** - **Fixture Simulator - Diff. Matching**.
- Step 2.** Press **Select Port**.
- Step 3.** Press **1**, **2**, or **3** to select the port on the DUT to which a differential matching circuit will be added.
- Step 4.** To add a matching circuit defined in a user file, perform the following operations:
 - a. Press **User File**.
 - b. Using the dialog box that appears, select the 2-port Touchstone data file (.s2p format) for the matching circuit to be added.

Once you have specified the user file, the selection of **Select Circuit** automatically changes to **User**. In this case, you do not have to execute Step 5 and Step 6.
- Step 5.** Press **Select Circuit**.
- Step 6.** Select a differential matching circuit model (Figure 7-19).

Softkey	Function
None	The matching circuit is not added.
Shunt L - Shunt C	Selects a circuit model consisting of a shunt inductor and a shunt capacitor
User	Selects the circuit model defined in the user file imported in Step 4

- Step 7.** Specify the values for the elements in the circuit model selected.

Softkey	Function
C	Specifies the capacitance [F]
G	Specifies the conductance [S]
L	Specifies the inductance [H]
R	Specifies the resistance [Ω]

NOTE When either of the two components of Shunt-L, “L” and “R”, is set to 0, the component is defined as "Short"; when both components are set to 0, they are defined as "Open."

- Step 8.** Repeat Step 3 to Step 7 to set up the differential matching circuit to be added to the selected ports on the DUT.
- Step 9.** Press **Diff. Matching** to turn the differential matching circuit **ON**.
- Step 10.** Press **Return**.

Step 11. If **Fixture Simulator** is **OFF**, press the key again to turn it **ON**.

Example of Using Fixture Simulator

In this section, the fixture simulation function is explained based on an evaluation example for a DUT (balanced SAW filter) with a balanced port.

Measurement circuit example for a DUT with balanced port

Figure 7-20 shows an example of a measurement circuit used to evaluate a balanced SAW filter. DUT port 1 is an unbalanced port connected to source impedance R_s and input matching circuit $L1$. DUT port 2 is a balanced port connected to an output matching circuit ($C1$, $C2$, and $L2$) and load resistance R_L .

Figure 7-20

Measurement circuit of balance SAW filter

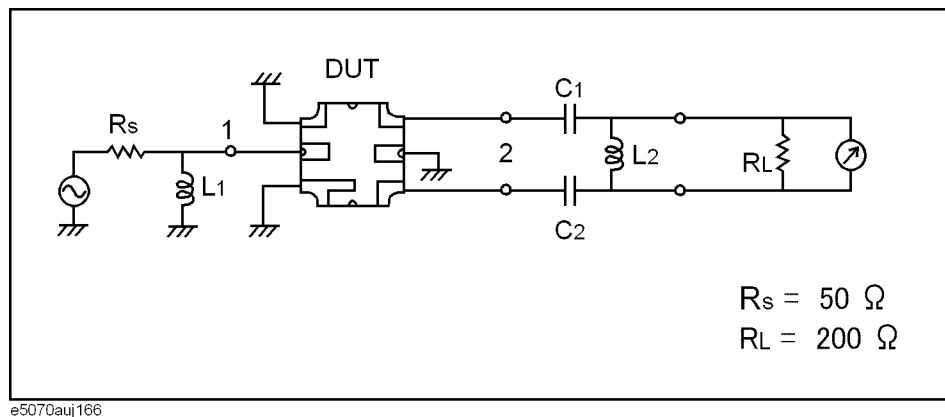

Evaluation using an actual test fixture

Generally, a test fixture as shown in Figure 7-21 is fabricated for evaluating the characteristics of a DUT in a measurement circuit by using a network analyzer.

In typical use, a network analyzer performs measurements at a 50Ω port reference impedance and in a single-ended (unbalanced) state. Therefore, DUT port 1 can be connected directly to the test port of the network analyzer.

On the other hand, DUT port 2 is a balanced port that cannot be connected directly to the test port of the network analyzer. Usually, a balun (BALance-UNbalance transformer) is used to convert the DUT's balanced port to an unbalanced port and to connect the converted port to the test port of the network analyzer. Matching circuits are mounted in the test fixture as shown in Figure 7-21.

Figure 7-21 DUT evaluation using an actual test fixture

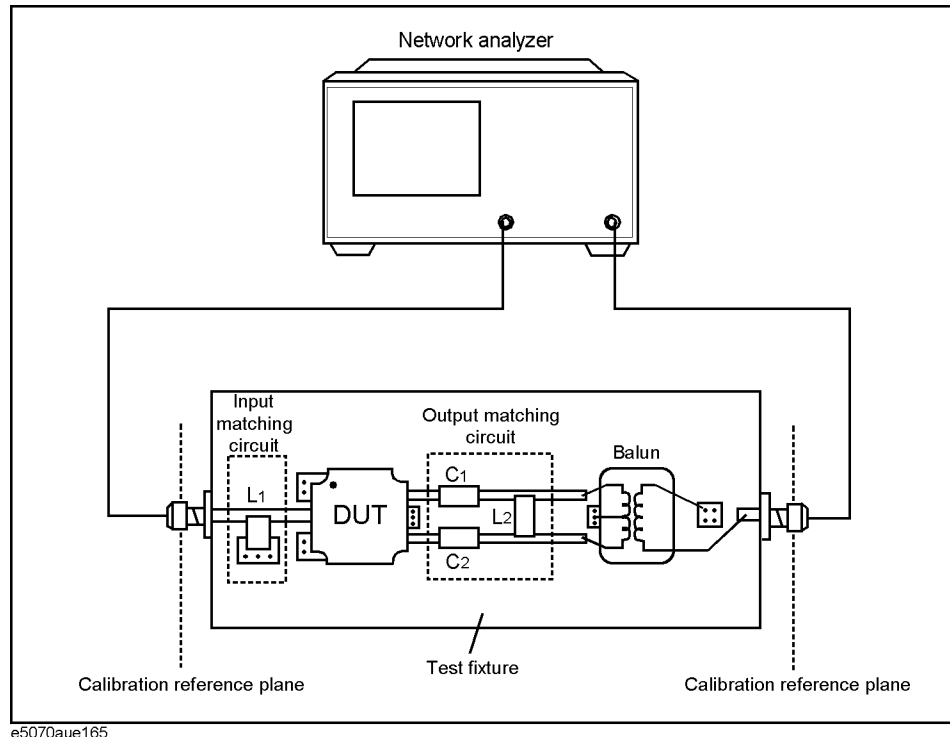

e5070aue165

Problems in measurement with an actual test fixture

Evaluating a balanced device with an actual test fixture involves the following problems:

- Calibration cannot be performed at the DUT's terminals. (A DUT's terminals are in the test fixture and calibration standards cannot be connected to them. In addition, it is very difficult to obtain calibration standards that can be used to calibrate a balanced port.) As a result, calibration is performed at appropriate connectors connected to the test fixture, and the network between the calibration reference plane and the DUT's terminals induces measurement errors.
- Different test fixtures must be fabricated for evaluating different types of DUTs because they require different characteristic impedances and matching circuits.
- An actual balun does not have ideal characteristics, so measurement error cannot be avoided. Furthermore, a common mode signal evaluation cannot be performed when an actual balun is used.

DUT evaluation using the E5070B/E5071B's fixture simulator

The E5070B/E5071B's fixture simulator function simulates a test fixture by using internal software instead of using an actual test fixture for evaluating DUTs.

Figure 7-22 shows an example connection for evaluating a DUT with the E5070B/E5071B's fixture simulator function. The unbalanced port of the DUT should be directly connected to a test port of the E5070B/E5071B, and the balanced port of the DUT should be connected to two other test ports of the E5070B/E5071B. The actual measurement by the E5070B/E5071B is performed at single-ended ports with a 50 Ω port reference impedance.

Figure 7-22

DUT connection when fixture simulator is used

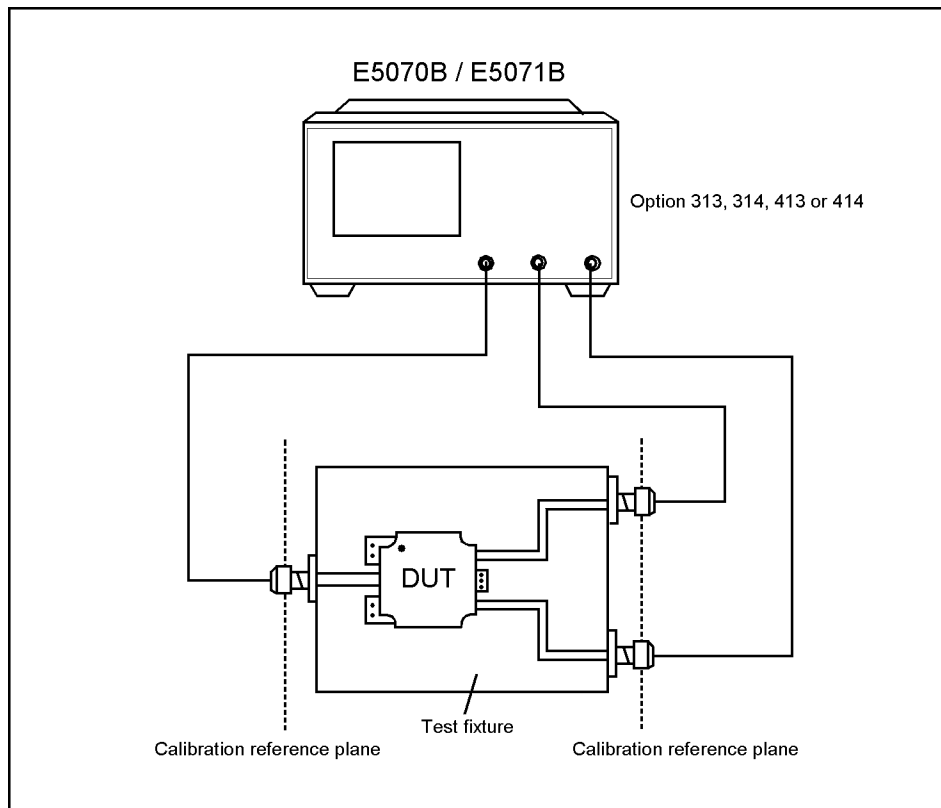

e5070bue019

Figure 7-23 shows the measurement circuit simulated by the fixture simulator based on actual measurement with the test fixture shown in Figure 7-22.

Figure 7-23 Measurement circuit simulated by fixture simulator

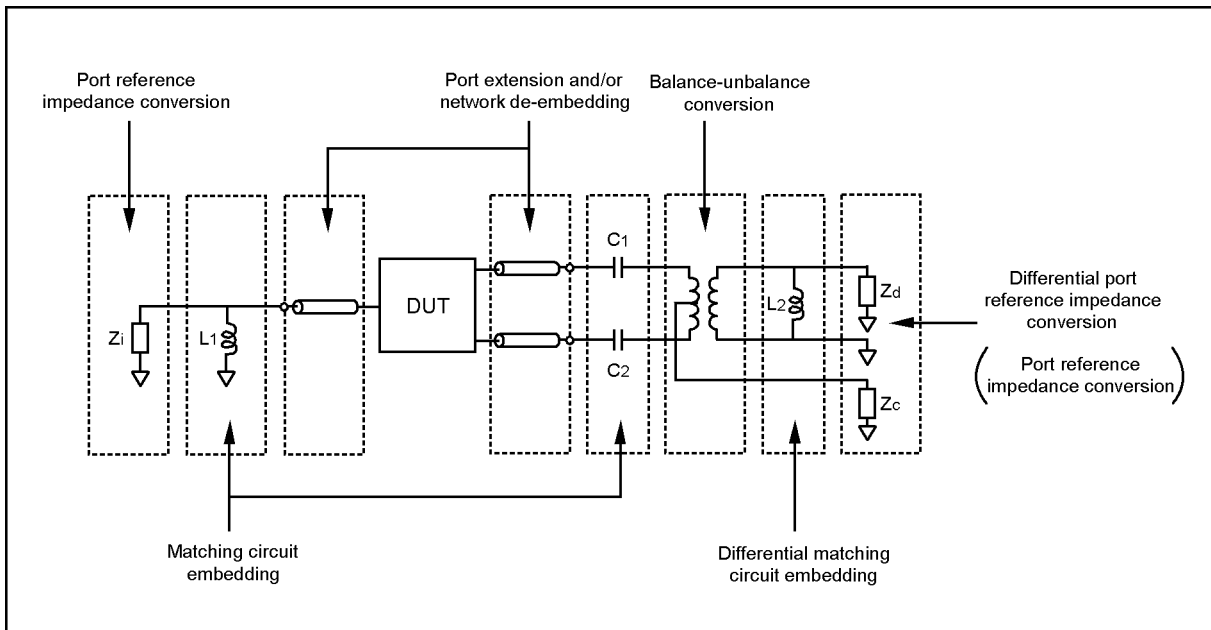

e5070aue168

First, the effect of an undesired network can be eliminated by port extension and/or network de-embedding. In Figure 7-22, since calibration standards cannot be connected to the DUT terminals to perform calibration, calibration should be performed at the connectors to the test fixture. Using port extension and/or network de-embedding enables you to remove an undesired network by using data processing and moving the calibration reference plane to the DUT's side equivalently. This function is performed for a single-ended port even if balance-unbalance conversion is applied to the port.

Port reference impedance conversion converts measured S-parameters to those at arbitrary port reference impedance. In Figure 7-22, since the single-ended port of the DUT is connected to the E5070B/E5071B's test port (50 Ω, single-ended), port reference impedance conversion is not required. This function is performed for a single-ended port even if balance-unbalance conversion is applied to the port.

Matching circuit embedding converts measured S-parameters to those when a matching circuit is added to the DUT's terminal. This function is performed for a single-ended port even if balance-unbalance conversion is applied to the port.

Balance-unbalance conversion converts S-parameters measured at an unbalanced state to mixed-mode S-parameters measured at a balanced state. The balanced port signal can be evaluated by using differential mode and common mode signals.

Differential matching circuit embedding converts measured S-parameters to those when a matching circuit is added to the DUT's differential mode port. (L2 in Figure 7-23)

Differential port reference impedance conversion converts a differential port reference impedance to an arbitrary impedance. Port reference impedance Z [Ω] at the two single-ended ports before balance conversion is automatically converted to $2Z$ [Ω] for differential mode port and $Z/2$ [Ω] for common mode port after balance conversion. Accordingly, if port reference impedance conversion is not performed for the two single-ended ports before balance conversion, differential mode port reference impedance Z_d becomes $50\ \Omega \times 2 = 100\ \Omega$, and common mode port reference impedance Z_c becomes $50\ \Omega / 2 = 25\ \Omega$. Since the differential port is terminated with 200 Ω in Figure 7-20, differential port reference impedance Z_d should be set to 200 Ω.

Advantages of balanced DUT evaluation using fixture simulator

Balanced device evaluation using the fixture simulator offers the following advantages:

- Calibration reference plane can be easily moved to the DUT's terminal after calibration is performed at the connectors where calibration standards can be connected. Undesired network can be removed to eliminate measurement errors (port extension, network de-embedding).
- Characteristics of a DUT, including desired matching circuits, can be obtained easily (matching circuit embedding, differential matching circuit embedding). Port reference impedance can be set freely (port reference impedance conversion, differential port reference impedance conversion).
- Differential mode and common mode signal evaluation (mixed-mode S-parameter evaluation) can be performed easily (balance-unbalance conversion).

8 **Frequency-Offset Measurement (Option 008)**

This chapter describes the frequency-translating device measurement and absolute measurement, including harmonic distortion measurement, made by using the frequency-offset mode (option 008).

Overview

Overview of Frequency-Offset Measurement

The E5070B/E5071B option 008 provides a frequency-offset function and an absolute measurement function.

Generally with network analyzers, the frequency must be the same both at the signal source and at the receiver, so frequency-translating devices such as mixers or converters cannot be measured. To enable the analyzer to measure frequency conversion devices, the receiver frequency must be synchronized with a frequency consisting of the input frequency and a certain added offset, which is called frequency-offset sweep.

The E5070B/E5071B option 008 provides not only this frequency-offset sweep but state-of-the-art mixer calibration features: vector-mixer calibration and scalar-mixer calibration. "Vector-Mixer Calibration" on page 223 allows you to measure the conversion loss, phase, reflection parameter, and group delay of the mixer. "Scalar-Mixer Calibration" on page 233 performs high-accuracy measurement for the magnitude and reflection parameter of mixer conversion loss.

Moreover, the E5070B/E5071B option 008 supports an absolute measurement function. The network analyzers normally measure the ratio of the test signal's magnitude and phase to the reference signal. In contrast, the absolute measurement function performs a measurement of the absolute value of the test signal's magnitude. In combination with the frequency-offset function, the absolute measurement function provides measurements that include measurement of harmonic distortion. It also provides high-accuracy measurement when combined with "Power Calibration" on page 208 and "Receiver Calibration" on page 220.

Measurement of Mixers

The frequency-offset function allows you to measure frequency-translating devices such as mixers.

Measurement flow

Table 8-1 shows the measurement flow.

Table 8-1 **Flow of Mixer Measurement**

Item	Description
"1. Setting Frequency-Offset" on page 313	Sets frequency-offset <ul style="list-style-type: none"> • Procedures for setting frequency at each port • Procedures for enabling frequency-offset function
"2. Setting External Signal Source" on page 316	Sets external signal source (source of LO signal) <ul style="list-style-type: none"> • Preparations for controlling external signal source • Procedures for setting external signal source GPIB address • Procedures for selecting external signal source • Procedures for setting external signal source frequency • Procedures for setting external signal source power level • Procedures for controlling external signal source
"3. Avoid Spurious Function" on page 320	Enables avoid spurious function. <ul style="list-style-type: none"> • Procedures for controlling avoid spurious function
"4. Changing Frequency Data" on page 321	Changes frequency data. <ul style="list-style-type: none"> • Procedures for changing frequency data
"5. Implementing Mixer Calibration" on page 323	Implements mixer calibration
"6. Conversion Loss Measurement" on page 323	Measures conversion loss of mixer <ul style="list-style-type: none"> • Connection of measured mixer • Procedures for setting measurement parameters • Procedures for changing measurement data

8. Frequency Offset Measurement (Option 008)

1. Setting Frequency-Offset

The frequency-offset function allows you to implement the measurements in which frequencies are different for each port, such as in mixer measurement. The frequency set for each port can be applied to the port even if it is for stimulus or receiver.

NOTE You can set the frequency-offset for each channel independently.

Frequency-Offset Measurement (Option 008)
Measurement of Mixers

Procedures for setting frequency at each port.

The frequencies set at Port-n (n: any port number) should be a multiplier (M_n), divisor (D_n) and offset (O_n) for the basic frequency setting shown in the following formula (refer to Figure 8-1):

$$\langle \text{Port (n) Frequency} \rangle = \langle \text{Basic Frequency} \rangle \times M_n / D_n + O_n$$

Figure 8-1

Example of frequency setting at each port

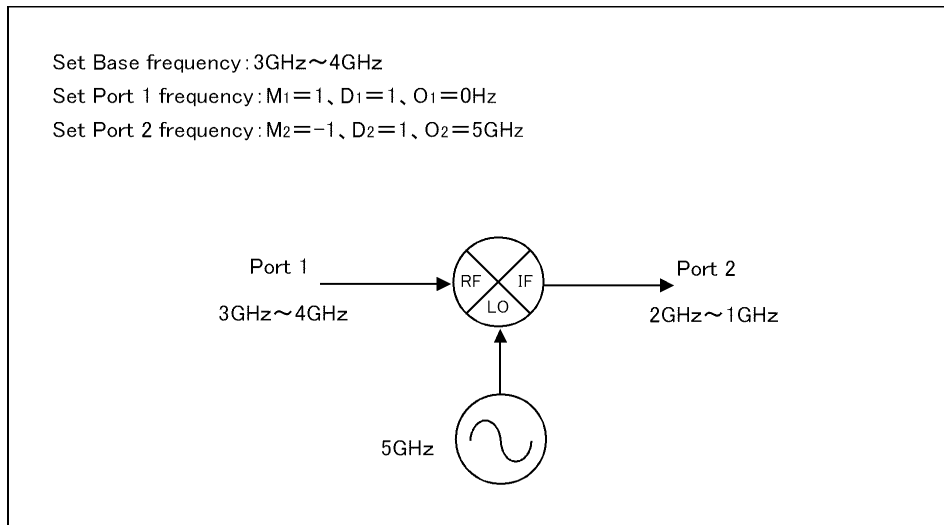

NOTE

The basic frequency is a frequency range set by the **Start** and **Stop** keys in the STIMULUS block.

Follow the steps below to set the frequency at each port.

- Step 1.** Press **Channel Next** (or **Channel Prev**) to activate the channel on which the frequency-offset is to be set.
- Step 2.** Press **Sweep Setup**-**Frequency Offset** to display “Frequency Offset Menu.”
- Step 3.** Press **Port n** (n: any port number) to display “Port n Menu.”
- Step 4.** Set the frequency for Port-n by using the following softkeys:

Softkey	Function
Multiplier	Sets a multiplier for the basic frequency
Divisor	Sets a divisor for the basic frequency
Offset	Sets an offset frequency for the basic frequency
Start	Sets a start frequency of the sweep range for Port-n
Stop	Sets a stop frequency of the sweep range for Port-n

NOTE

You can use both the **Multiplier/Divisor/Offset** key and **Start/Stop** key to set the frequency

for each port. The use of the **Multiplier/Divisor/Offset** key is recommended as a rule. In this way, the offset value is automatically retained even if you have changed the setting range of the basic frequency, since the correlation of the frequencies among ports is defined as a formula. Using **Start/Stop** key will set M and O, which can be determined from the specified frequency and the normal frequency, while maintaining the preset D.

Procedures for enabling frequency-offset function

Follow the steps below to enable the frequency-offset function.

- Step 1.** Press **Channel Next** (or **Channel Prev**) to activate the channel on which the frequency-offset is to be set.
- Step 2.** Press **Sweep Setup**-**Frequency Offset** to display “Frequency Offset Menu.”
- Step 3.** Press **Frequency Offset** to enable the frequency-offset function (ON).

NOTE

Keep in mind the following when you turn **ON** the frequency-offset function:

- If **Swept** is selected for the **Sweep Mode**, it will be changed to **Stepped** (from **Std Swept** to **Std Stepped**, and from **Fast Swept** to **Fast Stepped**).
- The phase information of the measurement value becomes meaningless. Therefore, the view of **Phase**, **Group Delay**, **Smith**, **Polar**, **Real**, **Imaginary**, **Expand Phase** or **Positive Phase** specified with the **Format** key has no actual meaning. In addition, any other function in the **Conversion** menu of the **Analysis** key that cannot be calculated without phase information, including the parameter conversion function, will not operate correctly.
- **Fixture Simulator** and **Time Domain (Transform, Gating)** are changed to **OFF**.
- If the measured frequency exceeds the measurable range (300 kHz to 3 GHz, or 8.5 GHz), an error will occur during the measurement.

- Step 4.** Once the frequency-offset function is enabled, the frequencies (Figure 8-2) set at each port are displayed for each measured trace in the lower part of the screen.

Figure 8-2

Frequency-offset sweep

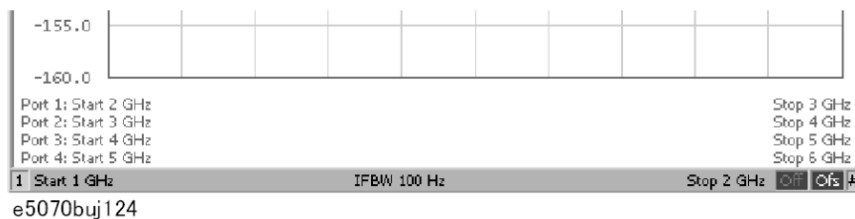

NOTE

If the frequency-offset function is turned **ON**, the number of sweeps during measurement will increase. For example, you can use two sweeps to measure the S-parameters of a 2-port setup in a normal frequency sweep; however, four sweeps are needed when the frequency-offset function is turned **ON**. This holds true regardless of whether the ports have the same frequency setting.

2. Setting External Signal Source

The E5070B/E5071B allows you to control the external signal source that is connected to USB/GPIB interface.

Preparations for controlling external signal source

To control the external signal source from the E5070B/E5071B, you must connect its USB port and the external signal source's GPIB connector via the USB/GPIB interface as shown in Figure 8-3. Then on the E5070B/E5071B you must specify the GPIB address and the type of external signal source.

Figure 8-3

Connection between external signal source and E5070B/E5071B

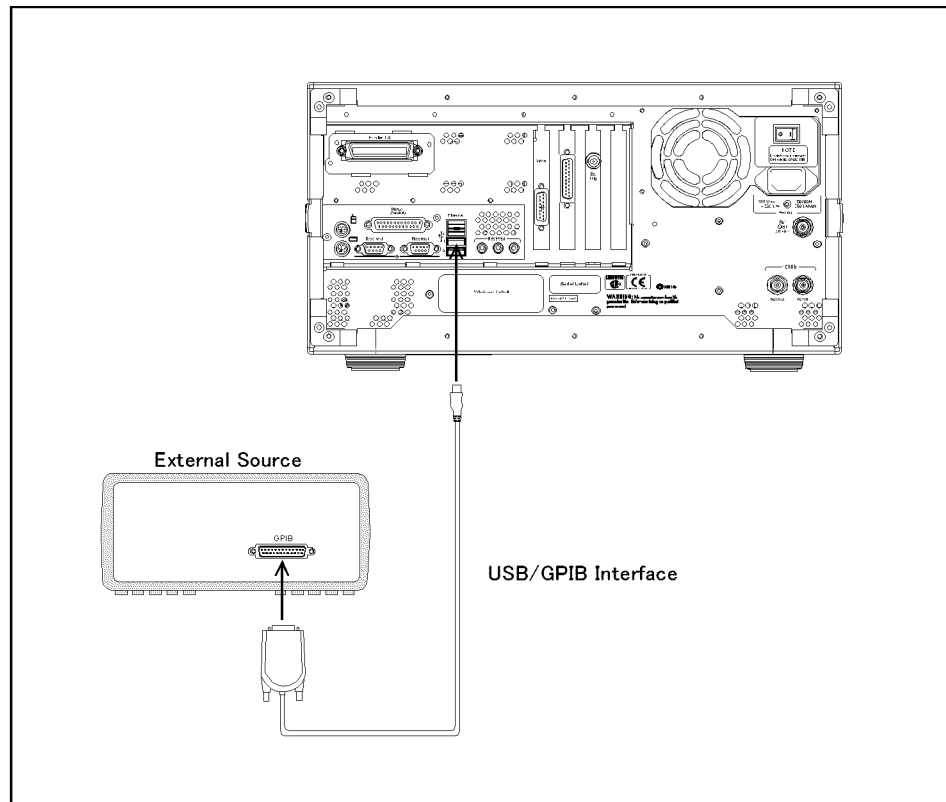

e5070bue134

NOTE

The settings of the USB/GPIB interface must be made in advance. See "Setting the GPIB" on page 426 for more information.

NOTE

To use an external signal source, we recommend that you connect the E5070B/E5071B's internal reference signal output connector and the external signal source's external reference signal input connector with BNC cable. This ensures stable measurement because the external signal source is phase-locked on the E5070B/E5071B's frequency reference signal.

Procedures for setting external signal source GPIB address

Follow the steps below to set GPIB address of the external signal source.

- Step 1.** Press **System**.
- Step 2.** Press **Misc Setup**.
- Step 3.** Press **GPIB Setup**.
- Step 4.** Press **Signal Generator Address**.
- Step 5.** Press **Address**.
- Step 6.** Type the GPIB address of the external signal source you want to use.

Procedures for selecting external signal source

The E5070B/E5071B can use the external signal sources shown in Table 8-2.

Table 8-2

Available External Signal Sources

Type	Model
1	User-defined Commands
2	8643A, 8644B, 8664A, 8665A/B
3	8648A/B/C/D, ESG Series, PSG Series

NOTE

For type 1, the user-defined commands can be used to control the external signal source. Four commands can be defined: preset, turning on RF output, setting frequency, and setting power. Definitions are required for frequency and power level settings.

The factory-state definitions are shown in Table 8-3.

Table 8-3

Factory-state Command Definitions

Function	Command	Description
Preset	""	Not defined
Turning on RF output	"R3"	
Frequency setting	"FR %f% HZ"	Frequency (Hz) is set to %f%
Power level setting	"AP %p% DM"	Power level (dBm) is set to %p%

Follow the steps below to select an external signal source.

- Step 1.** Press **System**.
- Step 2.** Press **Misc Setup**.
- Step 3.** Press **GPIB Setup**.
- Step 4.** Press **Signal Generator Address**.

Frequency-Offset Measurement (Option 008)
Measurement of Mixers

Step 5. Select the external signal source you want to use.

NOTE

Switching Time allows you to set the wait time after setting the external signal source's frequency and power in ms.

Procedures for setting external signal source frequency

The frequencies set to the external signal source should be a multiplier (M_{LO}), divisor (D_{LO}), and offset (O_{LO}) for the basic frequency setting as shown in the following formula (refer to Figure 8-4 or Figure 8-5):

$$\langle \text{LO Frequency} \rangle = \langle \text{Basic Frequency} \rangle \times M_{LO} / D_{LO} + O_{LO}$$

Figure 8-4

Example of external signal source frequency setting (swept IF measurement)

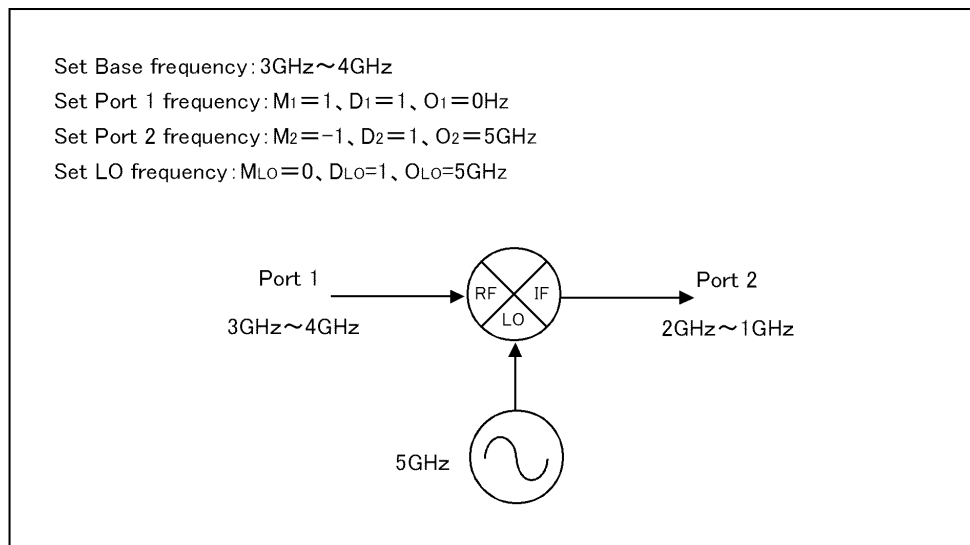
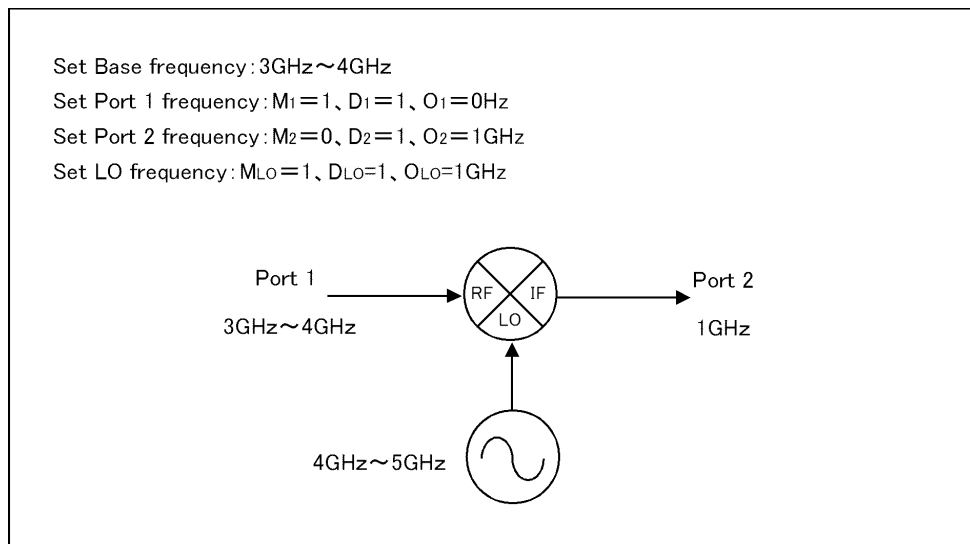

Figure 8-5

Example of external signal source frequency setting (fixed IF measurement)



NOTE The basic frequency is a frequency range set by the **Start** and **Stop** keys in the STIMULUS block.

Follow the steps below to set the external signal source frequency.

- Step 1.** Press **Sweep Setup** - **Frequency Offset** to display the “Frequency Offset Menu.”
- Step 2.** Press **External Source**.
- Step 3.** Set a frequency for the external signal source by using the following softkeys:

Softkey	Function
Multiplier	Sets a multiplier for the basic frequency
Divisor	Sets a divisor for the basic frequency
Offset	Sets an offset frequency for the basic frequency
Start	Sets a start frequency of the sweep range for the external signal source
Stop	Sets a stop frequency of the sweep range for the external signal source

NOTE You can use both the **Multiplier/Divisor/Offset** key and the **Start/Stop** key to set the external signal source frequency. The use of the **Multiplier/Divisor/Offset** key is recommended as a rule. This allows you to automatically retain the offset value even if you have changed the setting range of the basic frequency, since the external signal source frequency is defined as a formula. Using the **Start/Stop** key will set M and O, which can be determined from the specified frequency and the normal frequency, while maintaining the preset D.

Procedures for setting external signal source power level

Follow the steps below to set the external signal source power level.

- Step 1.** Press **Sweep Setup** - **Frequency Offset** to display the “Frequency Offset Menu.”
- Step 2.** Press **External Source** to display the “External Source Menu.”
- Step 3.** Press **Power**.
- Step 4.** Set the power level.

NOTE The mixer’s conversion loss and reflection coefficients are significantly affected by the power level variation of the external signal source (LO signal). The **Slope** provided in the “External Source Menu” allows you to set a correction in dB/GHz for the power level variation that may occur when you change the external signal source frequency.

Frequency-Offset Measurement (Option 008) Measurement of Mixers

Procedures for controlling external signal source

Follow the steps below to control an external signal source.

Step 1. Press **Sweep Setup** - **Frequency Offset** to display the “Frequency Offset Menu.”

Step 2. Press **External Source** to display the “External Source Menu.”

Step 3. Press **Frequency Format** to turn it **ON**. The frequency setting of the external signal source (LO) is displayed as shown in Figure 8-6.

Figure 8-6 Display of external signal source setting

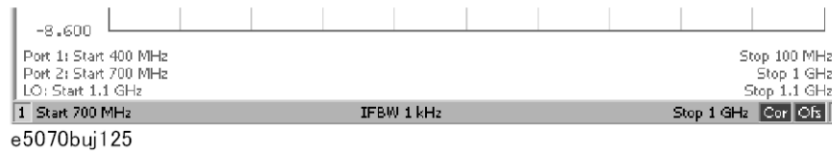

Step 4. Press **Control** to turn the external signal source control **ON**, which allows you to send setting values such as frequency to the external signal source and start the control. If the external signal source control is turned **ON**, (Ctrl) will be displayed on the screen as shown in Figure 8-7.

Figure 8-7 Display of external signal source control

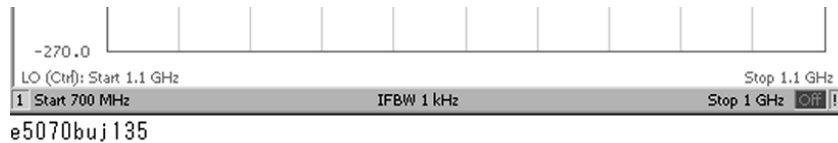

NOTE

If the external signal source control fails, the GPIB setting may be wrong. See "Setting the GPIB" on page 426.

3. Avoid Spurious Function

The E5070B/E5071B has the avoid spurious function (Figure 8-8). This function allows you to implement measurement by avoiding the spurious signal generated from the following signals:

- Stimulus signal and its harmonics
- Local signal within the receiver and its harmonics
- For an external signal source (if **LO Frequency** is turned **ON**), the set signal and its harmonics

Figure 8-8

Avoid Spurious Function

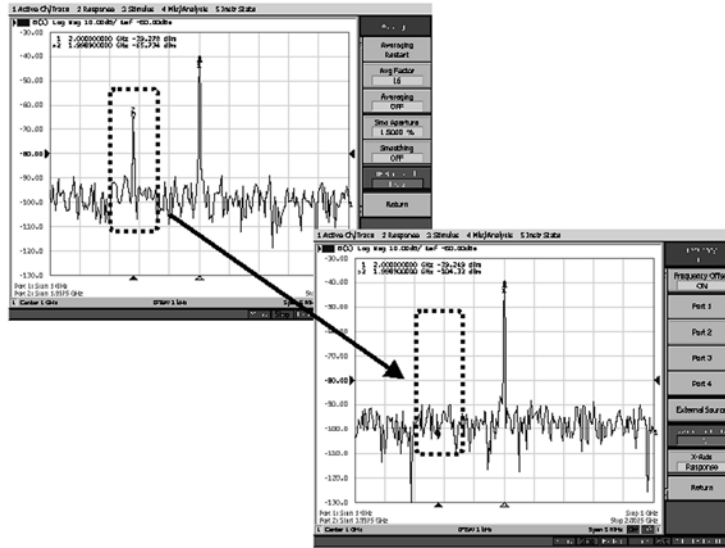

e5070buj126

NOTE You cannot avoid all spurious signals by using the avoid spurious function.

Procedures for controlling spurious avoidance function

Follow the steps below to control the spurious avoidance function.

- Step 1.** Press **Sweep Setup** - **Frequency Offset** to display the “Frequency Offset Menu.”
- Step 2.** Press **Avoid Spurious** to turn it ON.

NOTE Even if the frequency-offset function is turned **OFF**, the function is available when the external signal source (**LO Frequency**) is **ON**.

NOTE If the **Swept** is selected for the **Sweep Mode**, it will be changed to **Stepped** (from **Std Swept** to **Std Stepped**, and from **Fast Swept** to **Fast Stepped**).

4. Changing Frequency Data

The frequency-offset function offers the capability to change the frequency data of each trace to any desired frequency.

Procedures for changing frequency data

- Step 1.** Press **Channel Next** (or **Channel Prev**) and **Trace Next** (or **Trace Prev**) to activate the trace for which you want to change the frequency.
- Step 2.** Press **Sweep Setup** - **Frequency Offset** to display the “Frequency Offset Menu.”

8. Frequency Offset Measurement (Option 008)

Frequency-Offset Measurement (Option 008)
Measurement of Mixers

Step 3. Use the **X-Axis** key to set the frequency data.

Softkey	Function
Normal	Sets the basic frequency as frequency data
RF+LO	Sets IF frequency (RF+LO) as frequency data
RF-LO	Sets IF frequency (RF-LO) as frequency data
LO-RF	Sets IF frequency (LO-RF) as frequency data
Base	Sets the basic frequency as frequency data
Stimulus	Sets the stimulus port frequency as frequency data
Response	Sets the response port frequency as frequency data

NOTE When **Frequency Offset** is **OFF**, and **LO Frequency** is **ON** (mixer measurement by vector-mixer calibration), **Normal**, **RF+LO**, **RF-LO** and **LO-RF** are enabled. When **Frequency Offset** is **ON**, **Base**, **Stimulus** and **Response** are enabled. You can change the frequency data for each trace.

NOTE If you use the **LO-RF** setting, you can display information in the same way as with the mixer measurement function of the Agilent PNA series by changing the measurement data according to the steps below.

Step 1. Press **Channel Next** (or **Channel Prev**) and **Trace Next** (or **Trace Prev**) to activate the trace for which you want to change the measurement data.

Step 2. Press **Sweep Setup**-**Frequency Offset** to display the “Frequency Offset Menu.”

Step 3. Use the **X-Axis** key to change the frequency data.

Step 4. Use the **LO-RF** key to change the frequency data to IF frequency.

Step 5. Convert the measurement data to a complex conjugate number.

Step 6. Press the **Analysis** **Conversion** key to display the “Conversion Menu.”

Step 7. Press **Function** to select **Conjugation**.

Step 8. Press **Conversion** to turn it **ON**.

NOTE The basic frequency is a frequency range set by the **Start** and **Stop** keys in the STIMULUS bloc.

NOTE If you change the frequency data, it will affect all of the measurement values, such as the marker’s read value, conversion parameter, and conversion into time domain.

5. Implementing Mixer Calibration

The E5070B/E5071B provides a vector-mixer calibration function and a scalar calibration function for measuring frequency conversion devices.

For detailed information on mixer calibration, see "Vector-Mixer Calibration" on page 223 and "Scalar-Mixer Calibration" on page 233.

6. Conversion Loss Measurement

Conversion loss is a typical measurement parameter of a mixer. As shown in Figure 8-9, conversion loss indicates the level of efficiency in which input frequency is converted to another frequency. Furthermore, conversion loss can be defined as a proportion of output frequency power to input frequency power at a given LO signal level. The following description is based on an example of conversion loss measurement by using the vector-mixer calibration.

NOTE

You must implement vector-mixer calibration in advance. For detailed information on vector-mixer calibration, see "Vector-Mixer Calibration" on page 223.

Figure 8-9

Conversion loss of mixer

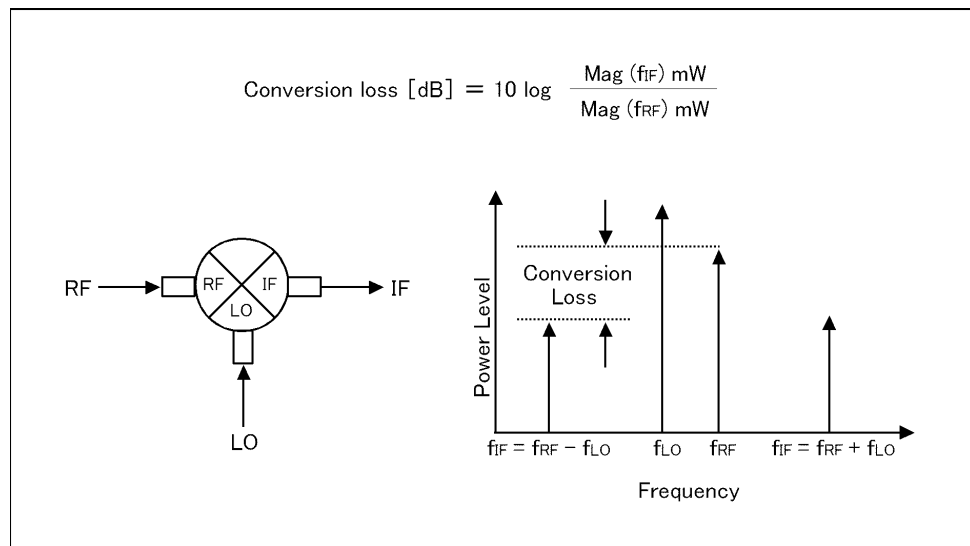

e5070bue127

Connection of measured mixer

Connect the calibration mixer with the IF filter, measured mixer and external signal source, as shown in Figure 8-10.

Figure 8-10 Connection of measured mixer

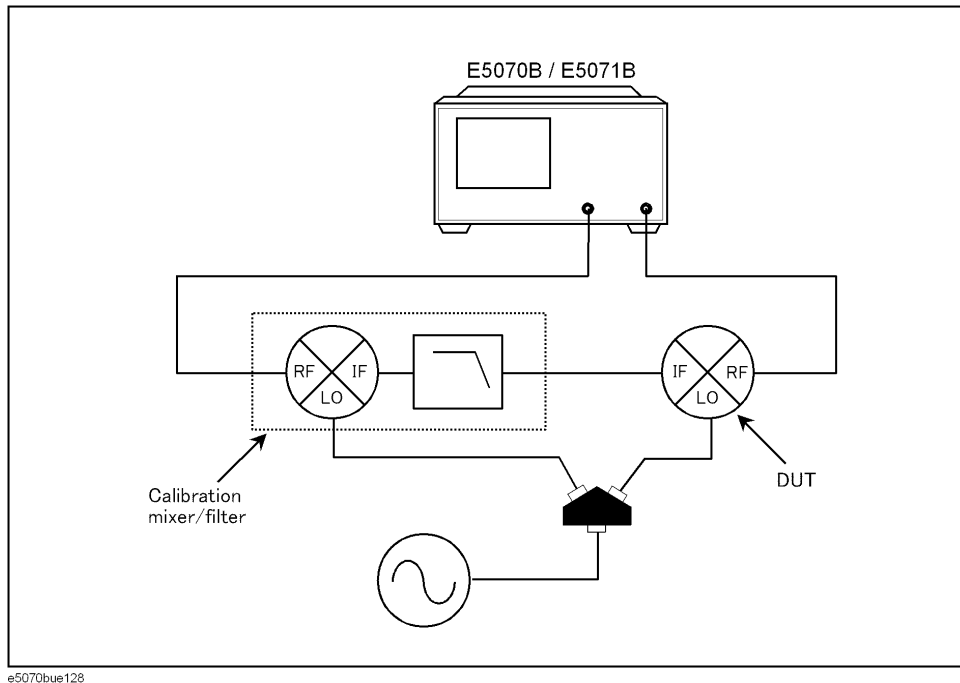

NOTE

If two or more spectrum components are involved at a similar level, it is necessary to use a filter in order to prevent unnecessary spectrum components from entering the receiver port; in this way, you can prevent the total magnitude from reaching a damage level of 6.3 Vp-p.

Procedure for setting measurement parameters

Follow the steps below to set the measurement parameters. In this case, we measure each parameter of magnitude, phase, and group delay in conversion loss (S12).

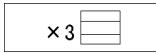
- Step 1.** Press **Channel Next** (or **Channel Prev**) to activate the channel you want to measure.
- Step 2.** Press **Display** to set **Num of Traces** to 3.
- Step 3.** Press **Allocate Traces** to select the Graph Layout ().
- Step 4.** Press **Meas** to set the measurement parameter to **S12**.
- Step 5.** Press **Format** to set **LogMag** (magnitude) to Trace 1.
- Step 6.** Press **Trace Next** to select Trace 2.
- Step 7.** Press **Meas** to set the measurement parameter to **S12**.
- Step 8.** Press **Format** to set **Phase** (phase) to Trace 2.
- Step 9.** Press **Trace Next** to select Trace 3.
- Step 10.** Press **Meas** to set the measurement parameter to **S12**.

Step 11. Press **Format** to set **Group Delay** (group delay) to Trace 3.

Step 12. Press **Scale** to use **Auto Scale All** for trace scale optimization (Figure 8-11).

Figure 8-11

Example of conversion loss measurement

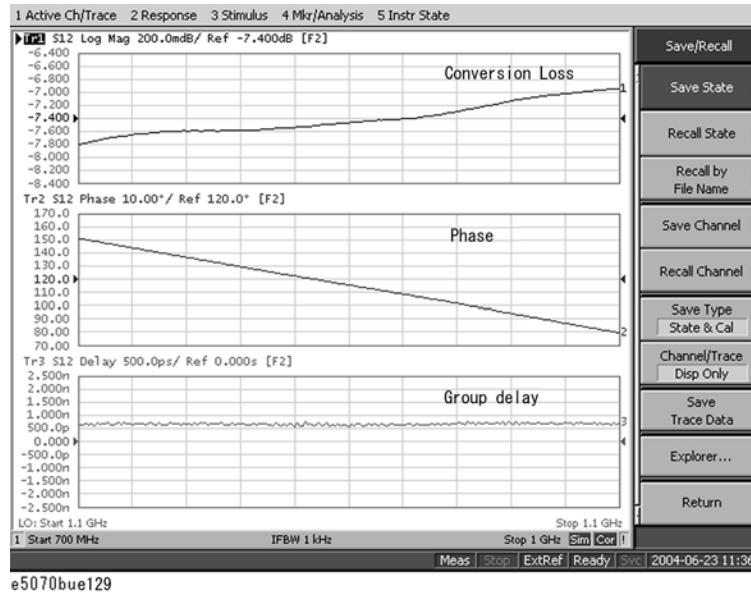

Step 13. Change the frequency data to the desired frequency as required. For detailed information on changing the frequency data, see "Procedures for changing frequency data" on page 321.

NOTE

For additional information about the absolute measurements, see Agilent application note 1463-6 “Accurate Frequency-Translating Device Measurements by using the Frequency-Offset Mode, 5989-1420EN”.

Measurement of Harmonic Distortion

Using the frequency-offset function and absolute measurement function in combination allows you to measure harmonic distortion of nonlinear devices such as mixers and amplifiers.

Measurement flow

Table 8-4 shows the measurement flow.

Table 8-4 Measurement Flow of Harmonic Distortion

Item	Description
"1. Setting Frequency-Offset" on page 313	Sets frequency-offset function
"2. Implementing Receiver Calibration" on page 327	Implements receiver calibration
"3. Setting Absolute Measurement Parameters" on page 327	Sets absolute measurement parameters <ul style="list-style-type: none">• Procedures for setting absolute measurement parameters
"4. Harmonic Distortion Measurement" on page 328	Implements harmonic distortion measurement <ul style="list-style-type: none">• Connection of DUT• Procedures for setting measurement parameters

1. Setting Frequency-Offset Function

The frequency-offset function allows you to make measurements while the frequencies are different at each test port. In this case, measurement is done by using the setting example for measurement frequency in Figure 8-12. For the setting of frequency-offset sweep, see "1. Setting Frequency-Offset" on page 313.

Figure 8-12

Example of measurement frequency

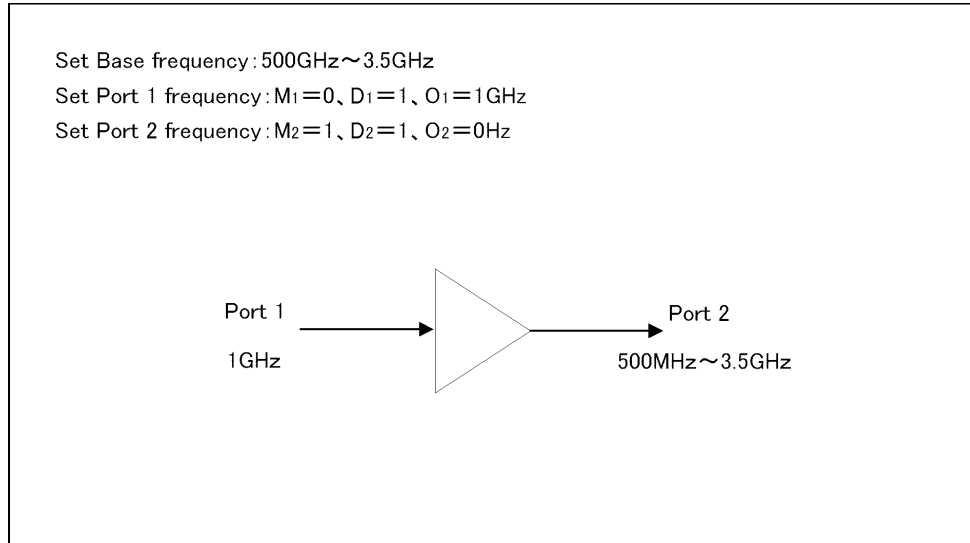

e5070bue130

2. Implementing Receiver Calibration

Receiver calibration is required for the absolute measurement. Receiver calibration of the port to be used for the measurement increases the accuracy in the absolute measurement. For detailed information on receiver calibration, see "Receiver Calibration" on page 220.

3. Setting Absolute Measurement Parameters

The frequency-offset function has an added absolute measurement function.

Procedures for setting absolute measurement parameters

Follow the steps below to set the absolute measurement parameters.

- Step 1.** Press **Channel Next** (or **Channel Prev**) and **Trace Next** (or **Trace Prev**) to activate the trace for which you want to implement absolute measurement.
- Step 2.** Press **Meas** to display the "Measurement Menu."
- Step 3.** Press **Absolute** to select measurement parameters.

Softkey*1	Function
A (n)	Absolute measurement in Port 1, test receiver
B (n)	Absolute measurement in Port 2, test receiver
C (n)	Absolute measurement in Port 3, test receiver
D (n)	Absolute measurement in Port 4, test receiver
R1 (n)	Absolute measurement in Port 1, reference receiver
R2 (n)	Absolute measurement in Port 2, reference receiver

8. Frequency Offset Measurement (Option 008)

Frequency-Offset Measurement (Option 008)
Measurement of Harmonic Distortion

Softkey*1	Function
R3 (n)	Absolute measurement in Port 3, reference receiver
R4 (n)	Absolute measurement in Port 4, reference receiver

*1. n in the parentheses is the stimulus port number.

4. Harmonic Distortion Measurement

Harmonic distortion is a typical measurement parameter of nonlinear devices such as mixers and amplifiers. As shown in Figure 8-13, the second and third distortions increase by square and cube values of the fundamental signal, respectively. Thus the distortion component increases as a function of the fundamental signal power, and the harmonic distortion can be measured as the proportion of the 2nd and 3rd harmonic power levels to the fundamental signal power level.

Figure 8-13

Harmonic distortion

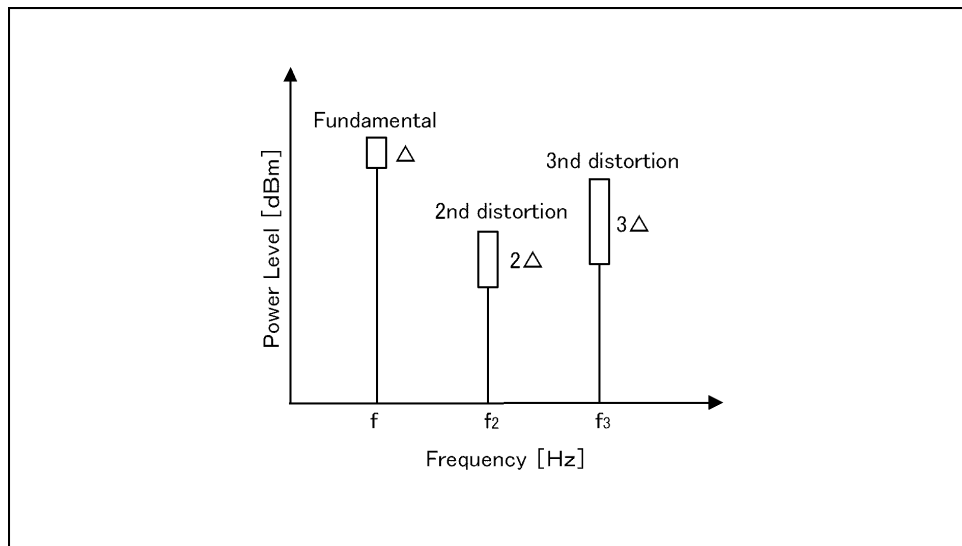

Connection of DUT

Connect the DUT, as shown in Figure 8-14.

Figure 8-14

Connection of DUT

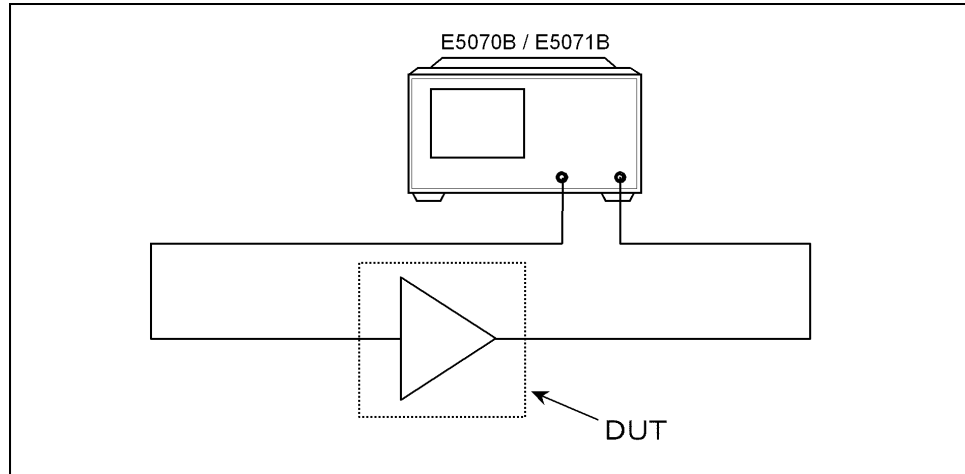

Procedures for setting measurement parameters

Follow the steps below to set the measurement parameters. In this case, we measure the harmonic distortion magnitude by using the frequency-offset sweep and the absolute measurement function, based on the E5070B/E5071B’s internal signal source.

NOTE

Receiver calibration is required before starting absolute measurement. For detailed information on receiver calibration, see "Receiver Calibration" on page 220.

- Step 1.** Press **Channel Next** (or **Channel Prev**) and **Trace Next** (or **Trace Prev**) to activate the trace for which you want to implement absolute measurement.
- Step 2.** Press **Meas** to display the “Measurement Menu.”
- Step 3.** Press **Absolute** to select absolute measurement parameters (**B (1)**). Accordingly, the stimulus port and test port are set to 1 and 2, respectively.
- Step 4.** In this case, the segment sweep function is used to perform faster measurement. For detailed information on segment sweep, see "Performing a Segment-by-Segment Sweep (segment sweep)" on page 415.
- Step 5.** Press **Sweep Setup**-**Edit Segment Table** to display the “Edit Segment Table Menu.”
- Step 6.** Set **Frequency Mode** to **Center/Span**.
- Step 7.** Refer to Table 8-5 to input numbers in the segment table, and then press **Return** to return to the “Sweep Setup Menu.”

Table 8-5

Segment Table Settings

Center	Span	Point
500 MHz	0 Hz	1
1 GHz	1 MHz	5
2 GHz	1 MHz	5

Frequency-Offset Measurement (Option 008)
Measurement of Harmonic Distortion

Table 8-5 Segment Table Settings

Center	Span	Point
3 GHz	1 MHz	5
3.5 GHz	0 Hz	1

Step 8. Set **Segment Display** to **Freq Base**.

Step 9. Press **Sweep Type** to select **Segment**.

Step 10. Press **Scale** to use Auto Scale All for trace scale optimization (Figure 8-15).

Figure 8-15 Example of Harmonic Distortion Measurement

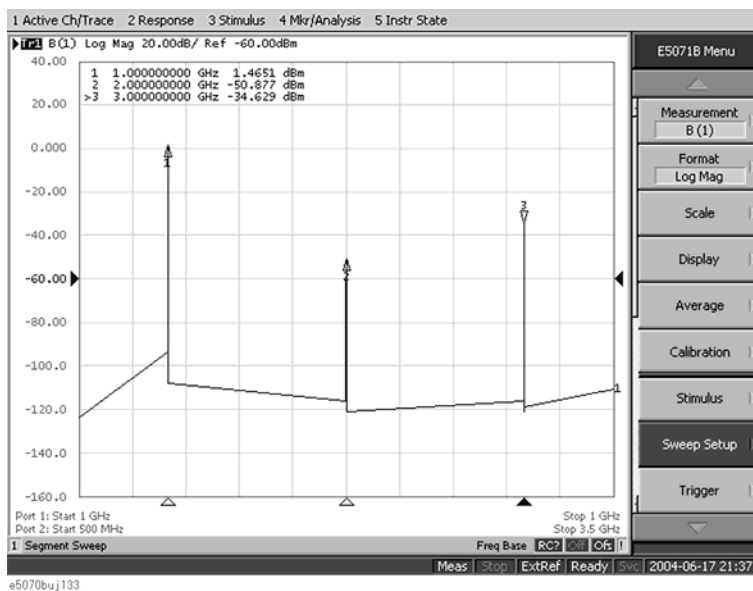

NOTE If you use the network analyzer as a tuning receiver like a spectrum analyzer, the setting must be the same at both the frequency point at which the harmonic is generated and the measurement point. Spectrum analyzers can detect all of the signals residing in the range of sweep frequencies, but network analyzers can only detect the signals residing in the measurement frequency point.

NOTE For additional information about the absolute measurements, see Agilent application note 1463-6 “Accurate Frequency-Translating Device Measurements by using the Frequency-Offset Mode, 5989-1420EN”.

9

Analysis in Time Domain (Option 010)

This chapter describes how to deal with responses in the time domain by using the time domain function (Option 010).

Overview

Overview of time domain measurement

The E5070B/E5071B Option 010 provides the time domain function, which is used to mathematically transform waveforms in the frequency domain that can be measured with a general network analyzer to waveforms in the time domain.

Figure 9-1 shows waveforms in the frequency domain and in the time domain when using the same cable. The waveform in the frequency domain shows ripples due to mismatches, but it is difficult to estimate their locations. On the other hand, from the waveform in the time domain, you can determine the locations and magnitudes of mismatches.

Figure 9-1

Example of measurement in time domain and in frequency domain

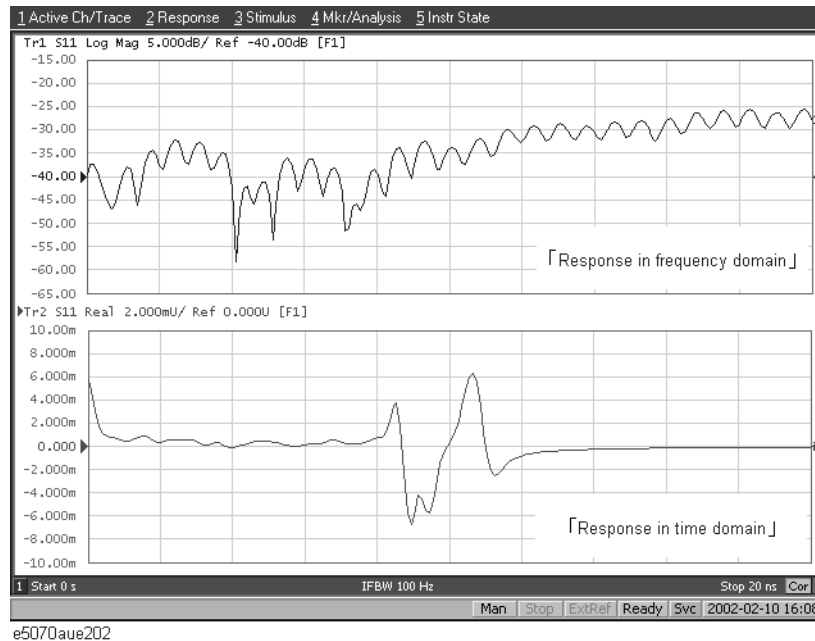

Comparison to time domain reflectometry (TDR) measurement

The time domain function of the E5070B/E5071B is similar to the time domain reflectometry (TDR) measurement in that it displays the response in the time domain.

In the TDR measurement, a pulse or step signal is inputted to the DUT and the change of the reflected wave over time is measured.

On the other hand, the time domain function of the E5070B/E5071B changes the frequency of the input signal to the DUT, performs measurement in the frequency domain, and transforms the result to the response in the time domain using the inverse Fourier transform.

Time domain function of E5070B/E5071B

The time domain function of the E5070B/E5071B is divided into the following two types of functions. You can use them at the same time.

- Transformation function
Transforms measurement data in the frequency domain to data in the time domain. For more information, refer to “Transformation to time domain” on page 334.
- Gating function
Deletes unnecessary data in the time domain from original data in the time domain. For more information, refer to “Deleting Unnecessary Data in Time Domain (gating)” on page 345.

Transformation to time domain

The transformation function lets you transform a response in the frequency domain to the corresponding response in the time domain.

Measurement flow

Table 9-1 shows the measurement flow of this transformation.

Table 9-1 Flow of transformation to time domain

Item	Description
“Selecting a type” on page 335	Selects the transformation type from the following. <ul style="list-style-type: none">• Band pass mode You can set the sweep range arbitrarily. This is suitable for devices through which signals within a certain frequency range pass such as filters.• Low pass mode Simulates the TDR measurement. This mode is suitable for devices through which dc current or signals of many frequencies pass, such as cables. The low pass mode provides two types of modes: low pass step and low pass impulse.
“Setting the window” on page 337	Sets the window to reduce the ringing phenomenon, in which a waveform’s waves are caused due to the fact that the frequency domain is finite.
“Calculating necessary measurement conditions” on page 338	Calculates the following values to obtain the necessary resolution and measurement range in the time domain. <ul style="list-style-type: none">• Sweep range• Number of points• Window width
“Setting the frequency range and the number of points” on page 342	Sets the sweep range and the number of points to the values calculated above.
“Setting display range” on page 343	Sets the range displayed on the graph.
“Enabling transformation function” on page 343	Enables the transformation function.

Selecting a type

There are two types of transformation to the time domain: band pass and low pass. The appropriate transformation type depends on the DUT.

Comparison between band pass mode and low pass mode

Item	Band pass	Low pass
Appropriate DUT	DUTs that do not operate with dc current such as band pass filters.	DUTs that operate with dc current such as cables.
Input signal	You can simulate the response to the impulse signal.	You can simulate the TDR measurement. You can simulate the response to both the impulse signal and step signal.
Selection of the sweep range	You can select the sweep range arbitrarily.	Because dc data are estimated from the first few points, the frequencies of measurement points must be multiples of the start frequency.
Transmission/reflection measurement	You can perform both transmission and reflection measurements.	You can perform both transmission and reflection measurements.
Identification of mismatches	You can identify the locations of mismatches.	You can identify the locations of mismatches and the type of impedance (capacitive or inductive).
Resolution		The resolution in the time domain increases by two times over that in the band pass mode.
Available data format	<input type="checkbox"/> Liner magnitude format <ul style="list-style-type: none"> • In the reflection measurement, it indicates the mean of the reflection coefficient within the frequency sweep range. • In the transmission measurement, it indicates the mean of the transmission coefficient within the frequency sweep range. <input type="checkbox"/> Log magnitude format <ul style="list-style-type: none"> • In the reflection measurement, it indicates the mean of the return loss within the frequency sweep range. • In the transmission measurement, it indicates the mean of the transmission gain within the frequency sweep range. <input type="checkbox"/> SWR format <ul style="list-style-type: none"> • In the reflection measurement, it indicates the mean of SWR (standing wave ratio) within the frequency sweep range. 	<input type="checkbox"/> Real format <ul style="list-style-type: none"> • In the low pass mode, the real format is useful because the time axis data do not have phase information.

Impulse signal and step signal

The E5070B/E5071B lets you simulate the response from the DUT to two types of signals: impulse signal and step signal. The impulse signal is a pulse-shape signal in which the voltage rises from 0 to a certain value and returns to 0 again. The pulse width depends on the frequency sweep range. The step signal is a signal in which the voltage rises from 0 to a certain value. The rise time depends on the maximum frequency within the frequency sweep range.

NOTE

For more information on how the frequency span setting affects the pulse width and the rise time, refer to “Calculating necessary measurement conditions” on page 338.

Figure 9-2

Step signal and impulse signal

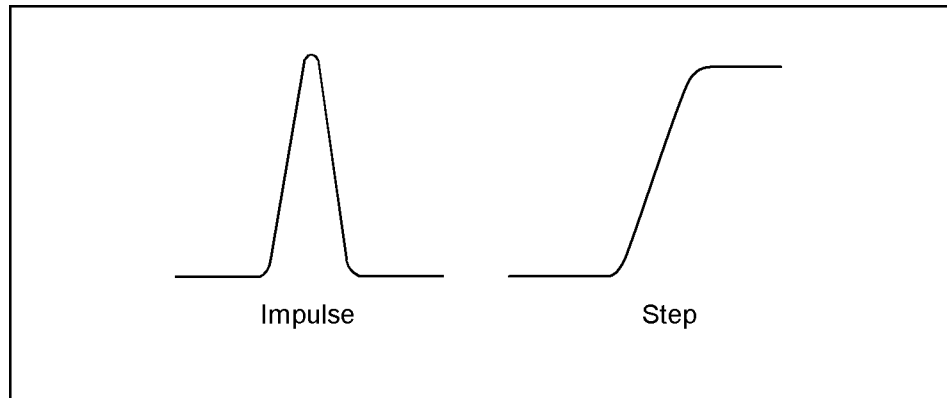

Operation

- Step 1.** Press **Channel Next** (or **Channel Prev**) and **Trace Next** (or **Trace Prev**) to activate a trace for which you want to set the transformation type.
- Step 2.** **Analysis** - Press **Transform** to display the “Transform” menu.
- Step 3.** **Type** and then press one of the following softkeys to specify the type.

Softkey	Function
Bandpass	Sets the transformation type to “band pass.”
Lowpass Step	Sets the transformation type to “lowpass step.”
Lowpass Imp.	Sets the transformation type to “lowpass impulse.”

- Step 4.** Press **Format** to display the “Format” menu and then select the data format.

Setting the window

Because the E5070B/E5071B transforms data within a finite frequency domain to data in the time domain, an unnatural change of data at the end points within the frequency domain occurs. For this reason, the following phenomena occur.

- Width of impulse signal and rise time of step signal
A time width occurs in the impulse signal and a rise time occurs in the step signal.
- Sidelobe
Sidelobes (small peaks around the maximum peak) occur in the impulse signal and the step signal. Ringing occurs on the trace due to sidelobes, which reduces the dynamic range.

By using the window function, you can lower the level of sidelobes. However, the width of the impulse and the rise time of the step become larger as a penalty. You can select from three types of windows: maximum, normal, and minimum. Table 9-2 shows the relation between the window and the sidelobe/impulse width.

Table 9-2 Characteristics of windows

Window	Sidelobe level of impulse signal	Width of impulse (50% in low pass mode ^{*1})	Sidelobe level of step signal	Rise time of step signal (10 – 90%)
Minimum	-13 dB	0.60/frequency span	-21 dB	0.45/frequency span
Normal	-44 dB	0.98/frequency span	-60 dB	0.99/frequency span
Maximum	-75 dB	1.39/frequency span	-70 dB	1.48/frequency span

*1. The value in the band pass mode is twice the value in the low pass mode.

The window function is available only when the response in the time domain is displayed. It does not have any effect when the response in frequency domain is displayed. Figure 9-3 shows the effect of the window when measuring the reflection of a short circuit in the time domain.

Figure 9-3 Effect of window on response from a short circuit in time domain

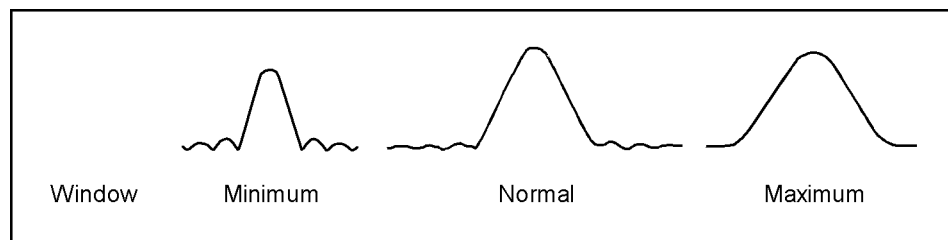

e5070aue216

Analysis in Time Domain (Option 010)

Transformation to time domain

Operation

- Step 1.** Press **Channel Next** (or **Channel Prev**) and **Trace Next** (or **Trace Prev**) to activate a trace for which you want to set the window.
- Step 2.** Press **Analysis** and then press **Transform** to display the “Transform” menu.
- Step 3.** Press **Window** and then select a window type.

Softkey	Function
Maximum	Sets the window type to maximum. β of the Kaiser Bessel function is set to 13.
Normal	Sets the window type to normal. β of the Kaiser Bessel function is set to 6.
Minimum	Sets the window type to minimum. β of the Kaiser Bessel function is set to 0.
Rise Time	Sets the window by specifying the impulse width or the step rise time. The lower limit can be set to the value when the window is the minimum, the upper limit when the window is the maximum.
Kaiser Beta	Sets the window by specifying the β value of the Kaiser Bessel function. The Kaiser Bessel function determines the shape of the window. The allowable setting range is 0 to 13.

NOTE

By specifying **Kaiser Beta**, **Impulse Width**, or **Rise Time**, you can specify a window that is not classified into the three window types. Conversely, when you specify a window type, these values are set automatically.

Calculating necessary measurement conditions

To use the transformation function efficiently, you need to make the following three settings appropriately.

- Resolution of the response
- Measurement range
- Sidelobe

This section describes the details of these settings.

Effect of frequency sweep range on response resolution

Figure 9-3 shows an example when measuring the same cable while changing the sweep span. When measured in a narrower sweep range, the overlap between two peaks is larger than when measured in a wider sweep range. By performing measurement in a wider sweep range, adjacent peaks can be clearly separated, which means that the response resolution is smaller.

Figure 9-4 Effect of frequency sweep range on resolution

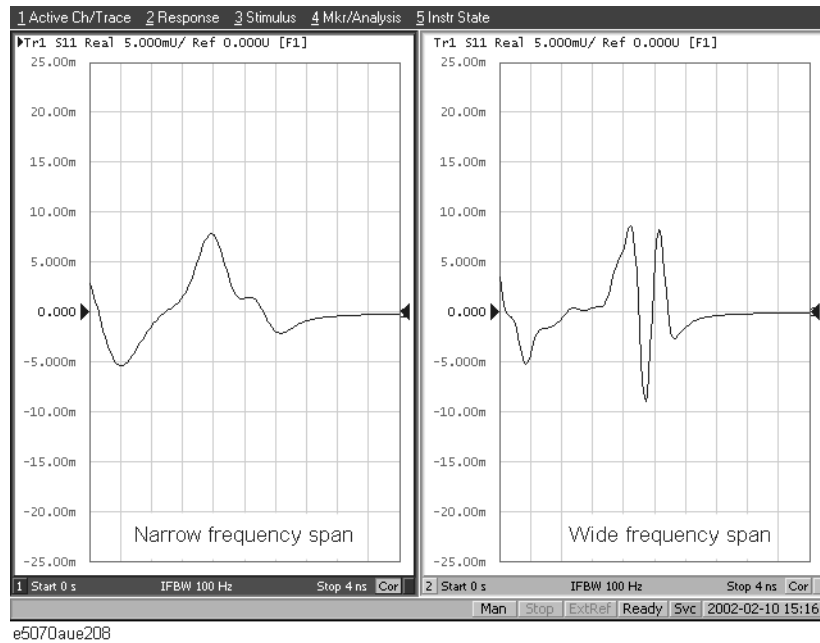

The sweep range affects the width of the impulse signal and the rise time of the step signal. The width of the impulse signal and the rise time of the step signal are inversely proportional to the sweep range. Therefore, the wider the sweep range is, the shorter these times are.

The resolution is equal to the width defined at the point of 50% of the impulse signal or the rise time defined at the points of 10% and 90% of the step signal. (Figure 9-5)

Figure 9-5 Definitions of impulse width and step rise time

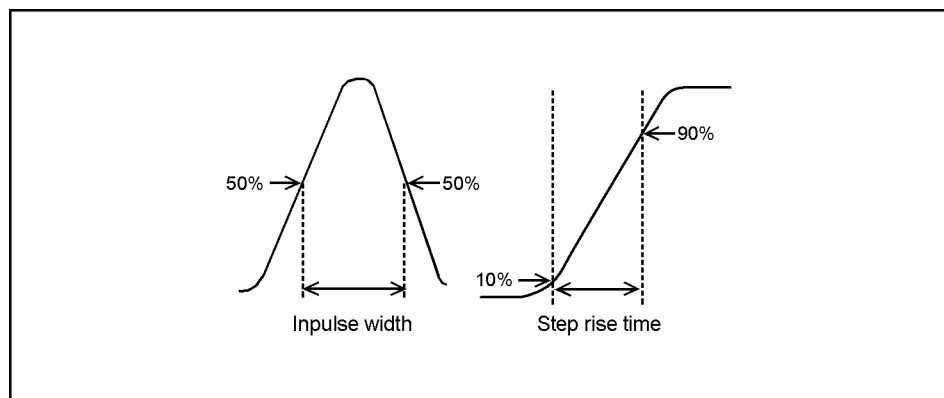

e5070aue215

Effect of the window function on the response resolution

Lowering the sidelobe level with the window function elongates the width of the impulse signal and the rise time of the step signal. As described in “Effect of frequency sweep range on response resolution” on page 339, because the response resolution is equal to the width of the impulse signal and the rise time of the step signal, lowering the sidelobe level enlarges the response resolution. Table 9-3 shows the relationship between the response resolution and the window setting.

Table 9-3

Correspondence of window setting and response resolution

Window	Low pass step	Low pass impulse	Band pass
Minimum	0.45/frequency span	0.60/frequency span	1.20/frequency span
Normal	0.99/frequency span	0.98/frequency span	1.95/frequency span
Maximum	1.48/frequency span	1.39/frequency span	2.77/frequency span

Figure 9-6 shows how the response changes as the window shape changes. If the magnitudes of adjacent peaks are comparable, you need to make the resolution higher; if they differ significantly, you need to set the window so that smaller peaks with lower sidelobes appear.

Figure 9-6

Effect of window on response resolution

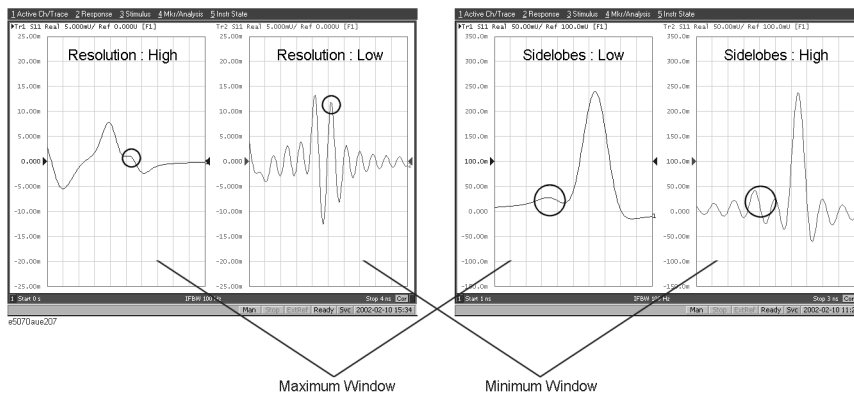

Effect of the transformation type on the response resolution

Although both transformation types, band pass and low pass impulse, simulate the response of the impulse signal, the impulse width in the low pass impulse mode is half the width of that in the band pass mode as shown in Table 9-1. Therefore, the resolution is better in the low pass mode. If the DUT can be measured in the low pass mode, response data with better resolution is obtained in the low pass mode.

Measurement range

In the time domain function, the measurement range means the range within which the response can be measured without repetition. The repetition of the response occurs because measurement in the frequency domain is performed discretely instead of continuously. The measurement range is inversely proportional to the frequency difference between adjacent measurement points. The frequency difference between measurement points ΔF is expressed as follows by using the span of the sweep frequency F_{span} and the number of points N_{meas} .

$$\Delta F = \frac{F_{span}}{N_{meas} - 1}$$

Therefore, the measurement range is proportional to the number of points– 1 and inversely proportional to the span of the sweep range. To enlarge the measurement range, use one of the following methods:

- Increase the number of points.
- Narrow the span of the sweep range.

NOTE

When you change the above settings after performing calibration, you need to perform calibration again.

The sweep range is expressed as time or distance. The time of the measurement range T_{span} is as follows:

$$T_{span} = \frac{1}{\Delta F}$$

The distance of the measurement range L_{span} is expressed as follows using the velocity factor V and the speed of light in a vacuum c (3×10^8 m/s).

$$L_{span} = \frac{Vc}{\Delta F}$$

NOTE

The maximum length of the DUT that can be measured in the transmission measurement is L_{span} . On the other hand, in the reflection measurement, because the signal goes and returns, it is 1/2 of L_{span} .

The velocity factor varies depending on the material through which the signal propagates: 0.66 for polyethylene and 0.7 for PTFE.

Changes in the settings and the changes in the response

Table 9-4 shows the effect of changes in the measurement conditions on the response

resolution and the measurement range.

Table 9-4 Effects of setting changes

Change in setting	Response resolution	Measurement range	Sidelobe
Widening the sweep range	Becomes smaller	Becomes narrower	Does not change
Setting the window type to maximum	Becomes larger	Does not change	Becomes lower
Increasing the number of points	Does not change	Becomes wider	Does not change

Setting the frequency range and the number of points

Operation

Step 1. Press **Channel Next** (or **Channel Prev**) to activate the channel you want to set.

NOTE The frequency range and the number of points are common to all of the traces in the channel. If you want to use different settings, make them on another channel.

Step 2. **Sweep Setup** - Press **Sweep Type - Lin Freq** to set the sweep type to “linear sweep.”

NOTE When the sweep type is set to other than the “linear sweep,” the time domain function is not available.

Step 3. Use the following keys to set the sweep range.

Key stroke	Function
Start	Sets the start frequency
Stop	Sets the stop frequency
Center	Sets the center frequency
Span	Sets the frequency span

Step 4. **Sweep Setup** - Press **Points** and then enter the number of points.

Step 5. When performing measurement in the low pass mode, press **Analysis - Transform - Set Freq Low Pass** to adjust the frequency range so that it is appropriate for the low pass mode. The frequency changes depending on the stop frequency as shown below.

Condition of stop frequency	Frequency setting
$> 300 \text{ kHz} \times \text{the number of points}$	Start frequency = stop frequency/number of points
$< 300 \text{ kHz} \times \text{the number of points}$	Start frequency: 300 kHz Stop frequency = 300 kHz \times number of points

When the frequency settings satisfy the conditions shown above, the **Set Freq Low Pass** key is displayed in gray.

Setting display range

The E5070B/E5071B has the following limitations on the display range you can set.

Lower limit $-T_{span}^{*1}$

Upper limit T_{span}^{*1}

The number of response points displayed on the graph is the same as the number of points regardless of the response resolution.

Operation

- Step 1.** Press **Channel Next** (or **Channel Prev**) and **Trace Next** (or **Trace Prev**) to activate the trace for which you want to set the display range.
- Step 2.** **Analysis** - Press **Transform** to display the “Transform” menu.
- Step 3.** Press each of the following softkeys and then specify the display range. At the side of the set value in the data entry bar, the distance corresponding to the set time is displayed (Figure 9-7). The displayed distance is a value taking the velocity factor into consideration.

Softkey	Function
Start	Sets the start value of the display range in time
Stop	Sets the stop value of the display range in time
Center	Sets the center value of the display range in time
Span	Sets the span of the display range in time

NOTE

You cannot use hardkeys to set the display. The hardkeys are dedicated to specifying the sweep range.

Figure 9-7

Data entry bar



e5070auj206

Enabling transformation function

Operation

- Step 1.** Press **Channel Next** (or **Channel Prev**) and **Trace Next** (or **Trace Prev**) to activate the trace for which you want to use the transformation type.
- Step 2.** **Analysis** - Press **Transform** to display the “Transform” menu.
- Step 3.** Press **Transform** to enable (**ON**) the transformation function.

*1. T_{span} is the measurement range expressed in time obtained in “Measurement range” on page 341.

Analysis in Time Domain (Option 010)
Transformation to time domain

NOTE

The following requirements must be met to enable the transformation function.

- The sweep mode is the linear sweep.
 - There are three or more measurement points.
-

Deleting Unnecessary Data in Time Domain (gating)

Measurement Flow

Table 9-1 shows the measurement flow, and Figure 9-8 shows the change in the waveform at each step of the flow.

Table 9-5 Measurement flow

Item	Description
1. Measurement in frequency domain	Executes measurement in frequency domain
2. Transformation to time domain	Enables transformation function and transforms measurement data to data in time domain
3. Setting the gate	Makes the following settings of the gate to select the necessary domain: <ul style="list-style-type: none"> • Gate type • Gate shape • Gate range
4. Transformation back to frequency domain	Disables transformation function and displays response in frequency domain corresponding to the data selected with the gate

Figure 9-8

Measurement flow

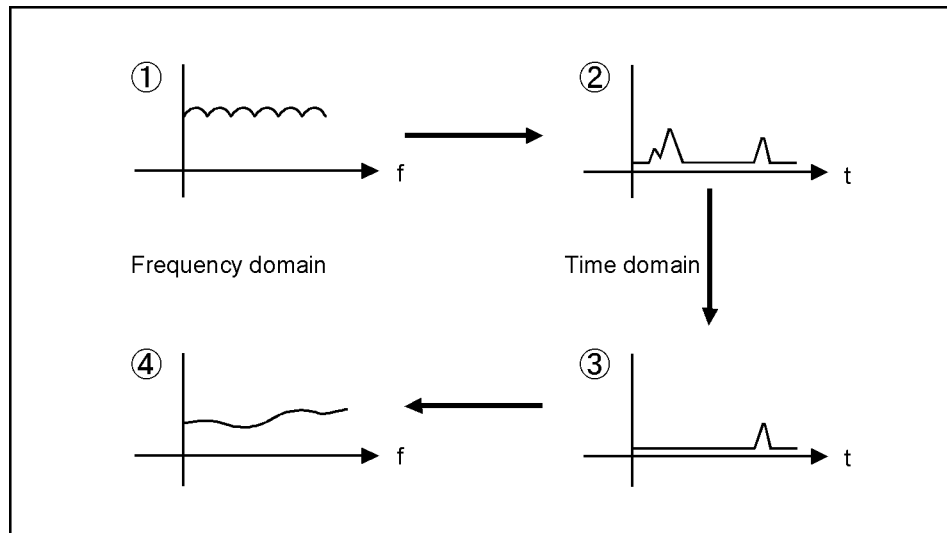

Setting gate type

The E5070B/E5071B lets you choose from the following two gate types:

Gate type	Description
Band pass	Deletes response outside the gate range
Notch	Deletes response inside the gate range

Operational procedure

- Step 1.** Press **Channel Next** (or **Channel Prev**) and **Trace Next** (or **Trace Prev**) to activate the trace for which you want to set the gate type.
- Step 2.** **Analysis** - Press **Gating** to display the “Gating” menu.
- Step 3.** Press **Type** to toggle between band pass (**Bandpass**) and notch (**Notch**).

Setting gate shape

The gate is a filter whose shape looks like a band pass filter. There are several parameters that indicate the gate shape. Figure 9-9 shows their definitions.

Figure 9-9

Parameters of gate shape

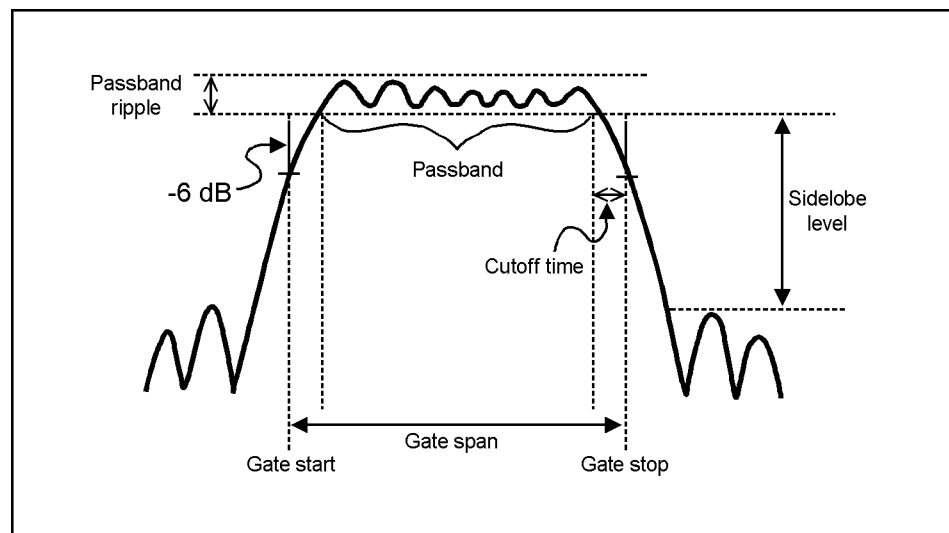

e5070aue213

Table 9-1 compares the characteristics according to the gate shape. When the shape is “minimum,” the cutoff time is shorter and the response is deleted abruptly, but the sidelobe level and band pass ripples become larger. When it is “maximum,” cutoff is gentler, but the sidelobe level and the band pass ripple become smaller. The minimum gate span in Table 9-1 is the minimum gate range you can set. This value is defined as the minimum gate span necessary for the existence of the pass band and is equal to 2 times the cutoff time.

Table 9-6 Comparison of gate characteristics

Gate shape	Passband ripple	Sidelobe level	Cutoff time	Minimum gate span
Minimum	±0.13 dB	-48 dB	1.4/frequency span	2.8/frequency span
Normal	±0.01 dB	-68 dB	2.8/frequency span	5.6/frequency span
Wide	±0.01 dB	-57 dB	4.4/frequency span	8.8/frequency span
Maximum	±0.01 dB	-70 dB	12.7/frequency span	25.4/frequency span

Operational procedure

- Step 1.** Press **Channel Next** (or **Channel Prev**) and **Trace Next** (or **Trace Prev**) to activate a trace for which you want to set the gate shape.
- Step 2.** **Analysis** - Press **Gating** to display the “Gating” menu.
- Step 3.** Press **Shape** and then select the gate shape from the following.

Softkey	Function
Maximum	Sets the gate shape to “maximum.”
Normal	Sets the gate shape to “normal.”
Wide	Sets the gate shape to “wide.”
Minimum	Sets the gate shape to “minimum.”

Setting gate range

Specify the gate range in time. The ends of the range are defined as the –6 dB attenuation points shown in Figure 9-9. You can set the gate range by specifying the start and stop times or the center and span. The E5070B/E5071B has the following limitations on the gate range you can set.

Lower limit $-T_{span}^{*1}$

Upper limit T_{span}^{*1}

Operational procedure

- Step 1.** Press **Channel Next** (or **Channel Prev**) and **Trace Next** (or **Trace Prev**) to activate the trace for which you want to set the gate range.
- Step 2.** **Analysis** - Press **Gating** to display the “Gating” menu.
- Step 3.** Press each of the following softkeys to specify the gate range. At the side of the set value area in the data entry bar, the distance corresponding to the set time is displayed as shown in Figure 9-7. The displayed distance is a value that takes the velocity factor into consideration.

Softkey	Function
Start	Sets the start time
Stop	Sets the stop time
Center	Sets the center of the gate in time
Span	Sets the gate span in time

NOTE No Hardkey is provided for this setting. The hardkeys are dedicated to setting the sweep

*1. T_{span} is the measurement range expressed in time obtained in “Measurement range” on page 341.

Analysis in Time Domain (Option 010)

Deleting Unnecessary Data in Time Domain (gating)

range.

NOTE

You can set the center and span by dragging and dropping flags indicating the gate range (Figure 9-10).

Enabling gating function

When you enable the gating function, data within the specified range is deleted. When the transformation function is enabled, the flags indicating the gate range is displayed as shown in Figure 9-10.

NOTE

In Figure 9-10, the gate type is set to band pass. When it is set to notch, the directions of the flags indicating the ends of the gate range are reversed.

Figure 9-10

Screen when transformation function and gate function are enabled

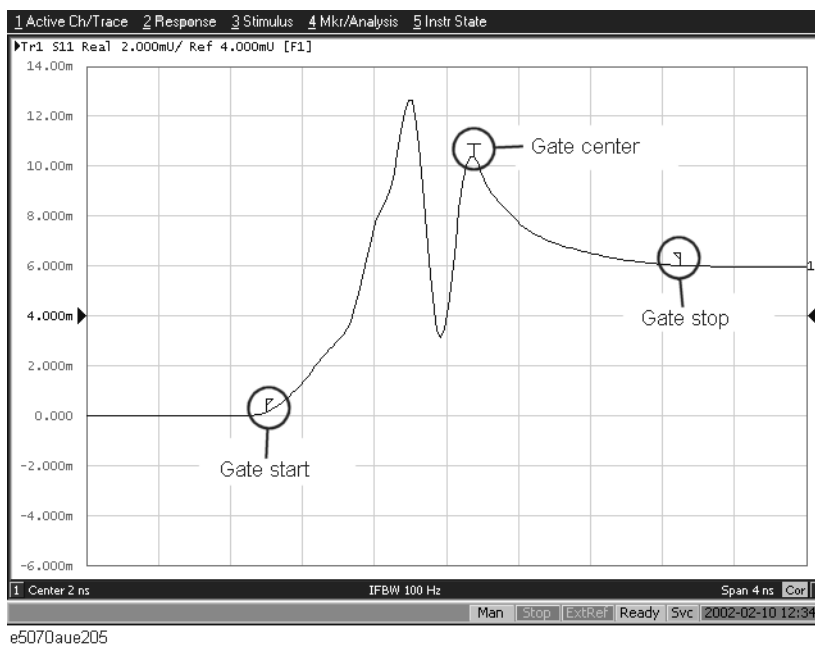

Operational procedure

- Step 1.** Press **Channel Next** (or **Channel Prev**) and **Trace Next** (or **Trace Prev**) to activate the trace for which you want to use the gate function.
- Step 2.** **Analysis** - Press **Gating** to display the “Gating” menu.
- Step 3.** Use **Gating** to enable (**ON**) the gate function.

Characteristics of Response in Time Domain

This section describes masking and the identification of the mismatch type, which are important for analyzing the response in the time domain.

Masking

Masking is a phenomenon in which a mismatch at a location near the calibration surface affects the response at the next mismatch location. This occurs because energy reflected by a mismatch at the location nearest to the calibration surface does not reach the next mismatch location. For example, when you measure the reflection of a cable that has 2 mismatch locations reflecting 50% of the input voltage, the first mismatch reflects 50% of the measurement signal. The remaining 50% reaches the next mismatch and its 50%, which is 25% of the entire measurement signal, is reflected. Therefore, in the response in the time domain, the second mismatch looks smaller.

NOTE

In this example, the transmission line is assumed to have no loss. However, because there actually is loss, the signal is attenuated as the distance from the calibration surface becomes greater.

Figure 9-11 shows an example of masking due to loss. It compares masking when a short termination is directly connected to the calibration surface and masking when a 6-dB attenuator is inserted. In either case, total reflection occurs at the short termination. In the latter case, the signal is attenuated in both ways, and the return loss appears to be -12 dB.

Figure 9-11

Example of masking

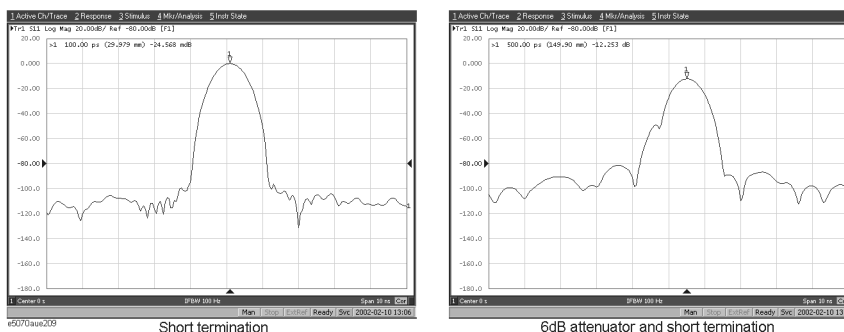







Identifying mismatch type

The transformation in the low pass mode simulates the response in the TDR measurement. In addition to mismatch locations, the response includes information on the mismatch type.

Figure 9-12 shows each mismatch type and the response waveform corresponding to it. In the low pass mode, you can simulate the response of the step signal and the impulse signal. From the viewpoint of mathematics, the response of the impulse signal is the waveform obtained by differentiating the response of the step signal.

Figure 9-12

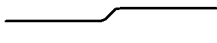
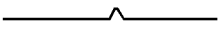
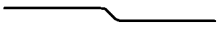
Mismatch type and response in low pass mode

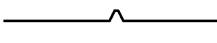
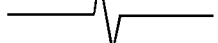
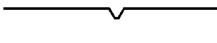
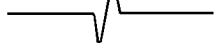
	Step response	Impulse Response
Open	 Unity Reflection	 Unity Reflection
Short	 Unity Reflection, -180°	 Unity Reflection, -180°
Resistor $R > Z_0$		
Resistor $R < Z_0$		
Inductor		
Capacitor		

e5070aue212

10 **Data Output**

This chapter explains the concepts behind saving/recalling internal data and printing the information that is displayed on the screen. Procedures for performing these tasks with the Agilent E5070B/E5071B are also given.

Saving and Recalling Instrument State

You can save the instrument state of the E5070B/E5071B into a file on mass storage (hard disk drive or floppy disk drive) and then recall it later to reproduce that state. You can select the stored data from the following four types.

Table 10-1

Stored data

Type	Stored data and usage
State only (State Only)	Saves the setting ^{*1} of the E5070B/E5071B and reproduces the state when it was saved by recalling it later into the E5070B/E5071B.
State and calibration data (State & Cal)	Saves the setting ^{*1} of the E5070B/E5071B and calibration data (calibration coefficient array ^{*2}) to reproduce the state when it was saved by recalling it later into the E5070B/E5071B. At this time, you can perform error correction of measured values by using the recalled calibration data.
State and trace (State & Trace)	Saves the setting ^{*1} of the E5070B/E5071B and traces (error-corrected data array ^{*2} and error-corrected memory array ^{*2}) to reproduce the state when it was saved by recalling it later into the E5070B/E5071B. At this time, the traces are also recalled and displayed on the screen.
State, calibration data, and traces (All)	Saves the setting ^{*1} of the E5070B/E5071B, calibration data, and traces to reproduce the state when it was saved by recalling it later into the E5070B/E5071B. At this time, the calibration data and traces are also recalled.

*1. For information on the saved target, refer to Appendix C, “List of Default Values.”

*2. For information on each array, refer to “Data Processing” on page 730.

In addition, the “user-preset” function is provided to allow the user to freely set up an instrument state recalled when the preset function is executed. For more information on how to set it up, see “Setting the user preset function” on page 449 .

Compatibility of files related to saving and recalling

The compatibility of saving/recalling the instrument state file is as follows:

Compatibility between different models

- Files saved with the E5070B cannot be recalled with the E5071B.
- Files saved with the E5070A can be recalled with the E5070B, although the opposite is not possible.
- Files saved with the E5071A can be recalled with the E5071B, although the opposite is not possible.

		Recalling			
		E5070B ^{*1}	E5071B ^{*2}	E5070A	E5071A
Saved file	E5070B ^{*1}	Y	N	N	N
	E5071B ^{*2}	N	Y	N	N
	E5070A	Y	N	Y	N
	E5071A	N	Y	N	Y

Y: Recall is possible. N: Recall is impossible.

- *1. Includes E5070A equipped with power sweep feature.
- *2. Includes E5071A equipped with power sweep feature.

- Compatibility between models that have different options (number of ports and power range expansion)
 - If the stored data is “state only (**State Only**),” files saved with a model having a smaller number of ports can be recalled with a model having a larger number of ports, but the opposite is not possible.
 - Files saved with a model not having the power range expansion feature can be recalled with a model having the power range expansion feature, but the opposite is not possible.

		Recalling							
		Power range expansion		Without			With		
				2	3	4	2	3	4
		Number of ports		213	313	413	214	314	414
		Option number		213	313	413	214	314	414
Saved file	Without	2	213	Y	Y/c	Y/c	Y	Y/c	Y/c
		3	313	N	Y	Y/c	N	Y	Y/c
		4	413	N	N	Y	N	N	Y
	With	2	214	N	N	N	Y	Y/c	Y/c
		3	314	N	N	N	N	Y	Y/c
		4	414	N	N	N	N	N	Y

Y: Recall is possible. N: Recall is impossible.
 Y/c: Only when the stored data is “state only (**State Only**),” recall is possible.

- Compatibility when the maximum number of channels/traces is different
 - You cannot recall files saved by specifying all channels/traces (**All**) as the save target.
 - If the number channels/traces at recall does not exceed that at save, you cannot recall files saved by specifying the displayed channel/trace (**Disp Only**) as the save target.
- Compatibility when the firmware version is different
 - Files that are saved with later firmware versions cannot be recalled by prior firmware versions.
 - Because Auto Power Range set function is added in firmware version 3.60, when recalling files that are saved with lower firmware versions, Auto Power Range set function is turned on with 3.60 and above firmware versions.*1
 - When Files that are saved with 3.54 and below include calibration data, only states and trace data are recalled with 3.60 and later firmware versions.
- Compatibility when the system spec. version (available with “:SERV:SREV?”) is different

*1. Except for options 213, 313, and 413.

- When Files that are saved with different system spec. versions include calibration data, only states and trace data are recalled.

NOTE If you recall an incompatible file, an error occurs and the device recovers to the presetting.

Save procedure

Selecting Content to be Saved

NOTE This setting takes effect both when saving the entire instrument state into a file and when saving the instrument state for each channel into memory.

Step 1. Press **Save/Recall**.

Step 2. Press **Save Type**.

Step 3. Press the softkey corresponding to the content of the instrument state you want to save.

Softkey	Function
State Only	Selects saving the state of the E5070B/E5071B only
State & Cal	Selects saving the state and calibration data of the E5070B/E5071B
State & Trace	Selects saving the state and traces of the E5070B/E5071B
All	Selects saving the state, calibration data, and traces of the E5070B/E5071B

Selecting Save Target Channel/Trace

Step 1. Press **Save/Recall**.

Step 2. Press **Channel/Trace** and select the save target from all channels/traces (**All**) or displayed channel/traces only (**Disp Only**).

If you specify the displayed channel/traces only as the save target, you can reduce the file size. However, for channels/traces that are not displayed, you cannot recall and reproduce the instrument state separately held for each channel/trace at a later time.

Saving Instrument State

Follow the procedure below to save internal data from the E5070B/E5071B.

Step 1. Press **Save/Recall**.

Step 2. Press **Save State**.

Step 3. When you want to use a pre-defined file name (State01.sta - State08.sta, Autorec.sta)

Press **State01 - State08** or **Autorec**.

NOTE If “A:\Autorec.sta” or “D:\Autorec.sta” is found on the system at startup, the E5070B/E5071B is automatically configured using the saved settings. When both files are found, “A:\Autorec.sta” is recalled. To disable the auto recall function, delete the Autorec.sta files.

NOTE An asterisk (*) in the upper right of the softkey indicates that the corresponding file of the softkey already exists. If you save into the existing file, the existing file is copied as “backup.sta” and then overwritten.

When you want to use another file name or a file name on the floppy disk

- 1. Press **File Dialog...** to open the Save As dialog box. Figure 10-1 illustrates the Save As dialog box.
- 2. Select the folder and input a file name using the external keyboard and mouse.
- 3. Click **Save**

Figure 10-1 Save As dialog box

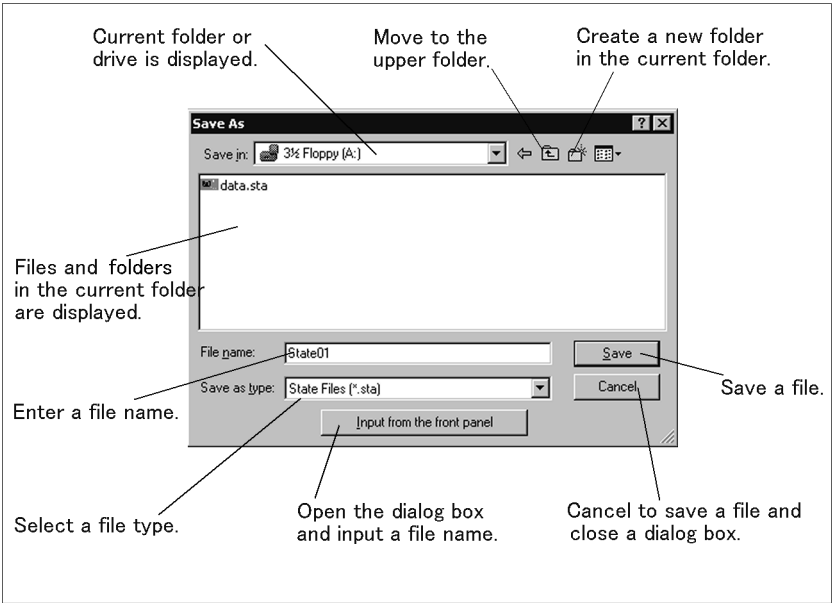

Data Output

Saving and Recalling Instrument State

On the E5070B/E5071B, the following drives are available for saving/recalling files. Select the appropriate drive from the **Save In** pull-down menu shown in Figure 10-1

Drive	Description
3.5" Floppy [A:]	Select this drive when saving or recalling a file to/from a floppy disk* ¹ .
[D:]	Select this drive when saving or recalling a file to/from the hard disk drive (D drive).

*1. When using the built-in floppy disk drive on the E5070B/E5071B, insert a 1.44 MB floppy disk formatted in DOS format.

NOTE Do not modify any files and folders in drives other than drive A: and drive D:. Doing so will cause malfunctions.

NOTE Do not press the disk eject button while the floppy disk access lamp is on. Trying to forcefully pull the floppy disk out while the lamp is on may damage the floppy disk or disk drive.

Typing in a file name from the front panel

You can enter a file name using the **Input from the front panel** buttons on the dialog box when storing a file.

Figure 10-2 Input from Front Panel

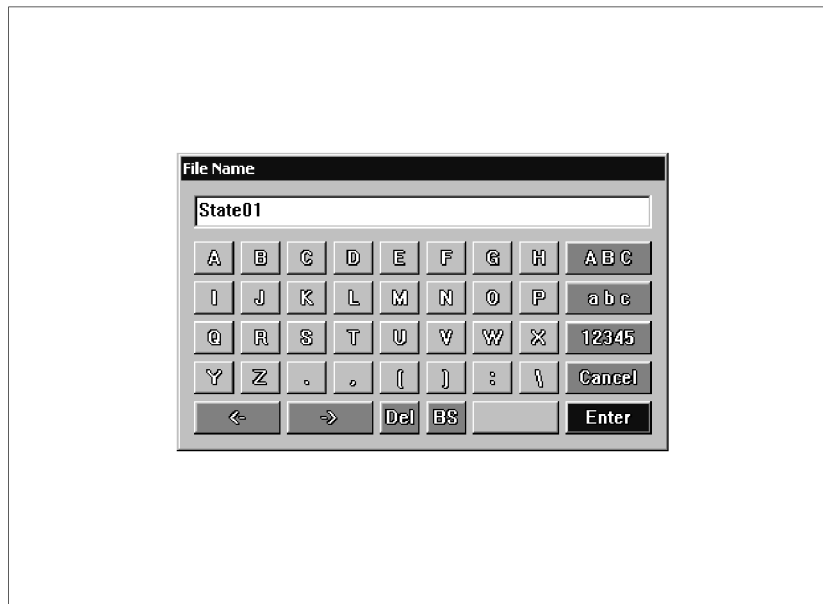

Recall Procedure

Follow the procedure below to recall internal data from the E5070B/E5071B.

NOTE

If you recall a file that includes traces (its content was set to **State &Trace** or **All** when it was saved), the trigger source is automatically set to Manual.

Step 1. Press **Save/Recall**.

Step 2. Press **Recall State**.

Step 3. When you want to recall State01.sta - State08.sta, Autorec.sta

Press **State01 - State08** or **Autorec**.

When you want to recall other files

1. Press **File Dialog...** to open the Open dialog box. Figure 10-3 illustrates the Open dialog box.
2. Select the folder and the file using the external keyboard and mouse.
3. Click **Open**.

Figure 10-3

Open dialog box

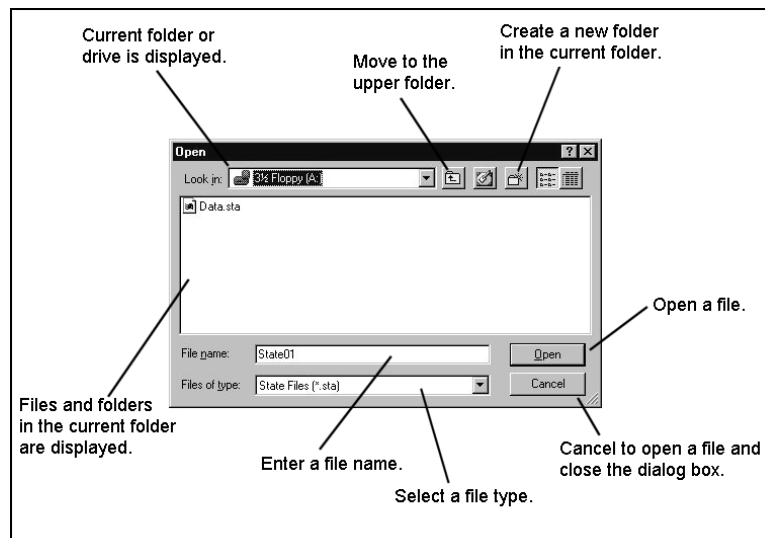

NOTE

Do not press the disk eject button while the floppy disk access lamp is on. Trying to forcefully pull the floppy disk out while the lamp is on may damage the floppy disk or disk drive.

NOTE

When a user file is used in “Extending the Calibration Plane Using Network De-embedding” on page 285, “Determining Characteristics After Adding a Matching Circuit” on page 287, or “Determining the Characteristics that Result from Adding a Matching Circuit to a Differential Port” on page 303 and the setup status is saved, a recall error will occur if the user file is not located in the same folder as when the state was saved.

Recall Procedure Using “Recall by File Name” Feature

You can use the recall feature with the **Recall by File Name** softkey for files you have named freely and saved in the **D:\State** folder. This function lets you recall a file you have named freely and saved by simple softkey operation, eliminating annoying operation using the Open dialog box.

NOTE

Although there is no limit to the number of files saved in a folder, only up to 50 files are displayed on the softkeys. If more than 50 files are saved in a folder, they are sorted in the order of numbers 0 to 9 and alphabetic characters A to Z and the first 50 files are displayed as softkeys.

Although there is no limit to the number of characters of a file name, only up to 12 characters are displayed on the softkey. If a file name exceeds 12 characters, the first 12 characters are displayed on the softkey and the remaining characters are omitted and replaced with "...".

Note that different files may be displayed on softkeys with the same name or a saved file is not displayed on any softkey because of the above limitations.

Step 1. Press **Save/Recall**.

Step 2. Press **Recall by File Name**.

Step 3. Files that have been named and saved in the D:\State folder are displayed on softkeys. Press the key for the file you want to recall.

Priority of recalling the configuration file at startup

If several instrument configuration files exist at the startup of the E5070B/E5071B, only one file is recalled and set at a time in the following order of priority.

If these files do not exist, the normal preset (factory preset) is executed.

Priority	Recalled file
1	Configuration file for the auto-recall function in the A drive
2	Configuration file for the auto-recall function in the D drive
3	Configuration file for the user-preset function in the D drive* ¹

*1. Executed when the preset operation mode is User and the file (D:\UserPreset.sta) exists.

Saving/Recalling Instrument State for Each Channel into/from Memory

The E5070B/E5071B allows you to save/recall the instrument state for each channel independently. This function allows you to save the instrument state of the active channel independently into one of four registers (A to D, volatile memory) and to recall the instrument state from the register to restore it as the state of the currently active channel. As in the case of saving the entire state of the instrument into a file, you can select items to be saved from four kinds (Table 10-1).

Since you can recall the instrument state for each channel that was saved with this function from a different channel that the one used to save it, this function is very useful for copying an instrument state between channels.

NOTE

Unlike when saving the entire instrument state, the instrument state for each channel is saved into volatile memory instead of a file, so if you turn off the power, this state is lost.

Operational Procedure

Saving Instrument State for Each Channel

- Step 1.** Press **Channel Next** or **Channel Prev** to activate a channel whose state you want to save.
- Step 2.** Press **Save/Recall**.
- Step 3.** Press **Save Channel**.
- Step 4.** Press one of **State A** to **State D** to save the instrument state of the active channel to the specified register.

NOTE

For registers having saved data, the * symbol is displayed to the right of their softkey label. If you specify one of these, its content is overwritten.

Recalling Instrument State for Each Channel

- Step 1.** Press **Channel Next** or **Channel Prev** to activate a channel whose state you want to recall and restore.
- Step 2.** Press **Save/Recall**.
- Step 3.** Press **Recall Channel**.
- Step 4.** Press the softkey of the register in which the state you want to restore is saved. This instrument state is recalled to the active channel.

Deleting the Saved Instrument States (clearing all registers)

- Step 1.** Press **Save/Recall**.
- Step 2.** Press **Save Channel**.
- Step 3.** Press **Clear States**. The contents of all the registers are deleted.

Saving Trace Data to a File

Saving data as a CSV file

The E5070B/E5071B allows the user to save data for the active trace on the active channel to a CSV file (file extension *.csv) and to load the data into PC application software for further processing.

Trace data are saved in the format shown below.

Example 10-1

Example of saved trace data

```
"# Channel 1"  
"# Trace 1"  
Frequency,          Formatted Data,      Formatted Data  
+3.0000000000E+005, +1.41837599227E-002, +1.43446459328E-006  
+4.2798500000E+007, +1.41275293412E-002, +2.02407834551E-004  
+8.5297000000E+007, +1.41334093048E-002, +4.00643331604E-004  
+1.2779550000E+008, +1.41240661092E-002, +6.09250514670E-004  
+1.7029400000E+008, +1.41402155348E-002, +8.05620003993E-004
```

The first line shows the number of the active channel at the time the data was saved.

The second line shows the number of the active trace at the time the data was saved.

The third line is a header line indicating the contents of each item of trace data written on the fourth line onward.

The fourth line onward shows the trace data. The amount of data is determined by the number of points (frequency) assigned to the trace.

Saving Trace Data

Follow the procedure below to save trace data from the E5070B/E5071B.

- Step 1.** Press or to select the channel that contains the trace to be saved.
- Step 2.** Press or to select the trace to be saved.
- Step 3.** Press to open the Save/Recall menu.
- Step 4.** Press **Save Trace Data** to open the Save As dialog box. When the dialog box appears, use the external keyboard and mouse to complete the task. For more information on the Save As dialog box, see Figure 10-1, “Save As dialog box,” on page 355. Note that “CSV Files (*.csv)” will already be selected as the file type when the dialog box first opens.
- Step 5.** Select the destination folder and input a file name. Press **Save** to save the file.

NOTE

Do not press the disk eject button while the floppy disk access lamp is on. Trying to forcefully pull the floppy disk out while the lamp is on may damage the floppy disk or disk drive.

Saving data in Touchstone format

You can also save trace data of a E5070B/E5071B active channel to a Touchstone format file, based on 1- to 4-port models.

Touchstone file data format

You can save data in “log magnitude - angle”, “linear magnitude - angle”, or “real number - imaginary number.”

When AUTO is selected, the data format is automatically set according to the display format of the active trace. However, when the display format of the active trace is set to one other than log magnitude format (LogMag), linear magnitude format (LinMag), or real-imaginary number format (Real/Imag), the data format is automatically set to real-imaginary number.

You can use data saved in Touchstone format for a circuit simulator such as Agilent Advanced Design System (ADS) on your PC (personal computer) or workstation. For more information on the ADS, refer to the operation manual that comes with the system.

NOTE

The fixture simulator function enables you to recall to the E5070B/E5071B the s2p (2-port Touchstone file) file type used to save user-defined matching circuit information. However, no other type of file saved in Touchstone format can be recalled to the E5070B/E5071B.

The function for saving data in Touchstone format is available from the front panel with the firmware version A.06.50. or higher. Accordingly, the function for saving data in Touchstone format by using VBA macro has been deleted.

When using the E5070B/E5071B with a firmware version A.06.00 or lower, you can save data in Touchstone format using VBA macro. For details, refer to Appendix A, “Manual Changes,” on page 583.

File types of Touchstone files

File types of the E5070B/E5071B Touchstone files are s1p, s2p, s3p, and s4p. The file type indicates the number of ports of the data structure that is output to the Touchstone file.

Data structure in Touchstone file

Data structure of the Touchstone file consists of a header part and a data part. The contents of the file is text data, which is ready to be read with a general text editor.

The header part consists of the returned value of *IDN?, file created date, calibration state, list of all S parameters of a specified port, and format information.

The header parts of s1p and s4p are shown below.

Table 10-2

Header of s1p

<pre>!Agilent Technologies,E5071B,<ID>,<FW Revision> !Date <Date> !Data & Calibration Information !Freq Sww:Method(Stat) # Hz S FMT R Z0</pre>
--

Table 10-3 Header of s4p

```
!Agilent Technologies,E5071B,<ID>,<FW Revision>
!Date <Date>
!Data & Calibration Information
!Freq Sww:Method(Stat) Sxw:Method(Stat) Syw:Method(Stat) Szw:Method(Stat)
.
.
.
Swz:Method(Stat) Sxz:Method(Stat) Syz:Method(Stat) Szz:Method(Stat)
# Hz S FMT R Z0
```

Each item has the following meaning.

Sww to Szz	S parameters of the selected test port; corresponds in ascending order, beginning with 1 to w.
Stat	State of S parameter calibration (ON or OFF) ON = Calibration is performed. OFF = Calibration is not performed.
FMT	Data format RI = Real number- imaginary number MA = Linear magnitude - angle DB = Log magnitude - angle
Z0	Reference impedance value

The structure of the data part depends on the combination of the selected file type and specified port.

NOTE When the S parameter of a port on which calibration is not performed is specified, if data measured with the S parameter exists, that data are output to a Touchstone file. If no measurement data exists, 0 (for log magnitude - angle, log magnitude = -200 dB) is output in the corresponding field.

Figure 10-4 through Figure 10-7 show the data structures of files saved in Touchstone format.

Figure 10-4 1-port Touchstone file

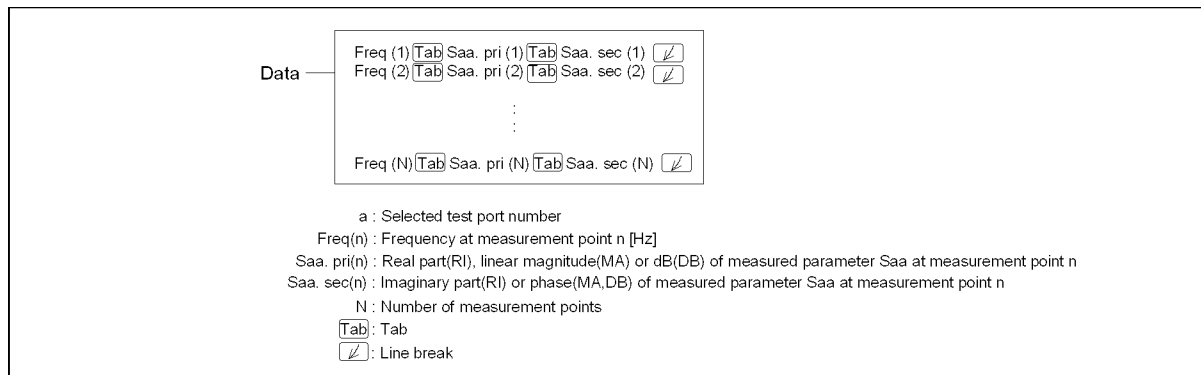

e5070bue9001

Figure 10-5 2-port Touchstone file

```

Freq (1)  Saa. pri (1)  Saa. sec (1)  Sba. pri (1)  Sba. sec (1)  Sab. pri (1)  Sab. sec (1)  Sbb. pri (1)  Sbb. sec (1) 
Freq (2)  Saa. pri (2)  Saa. sec (2)  Sba. pri (2)  Sba. sec (2)  Sab. pri (2)  Sab. sec (2)  Sbb. pri (2)  Sbb. sec (2) 
:
:
Freq (N)  Saa. pri (N)  Saa. sec (N)  Sba. pri (N)  Sba. sec (N)  Sab. pri (N)  Sab. sec (N)  Sbb. pri (N)  Sbb. sec (N) 
    
```

Data

a - b : Selected test port number (corresponding in ascending order, beginning with 1 to a)
 Freq(n) : Frequency at measurement point n [Hz]
 Sxy. pri(n) : Real part(RI), linear magnitude(MA) or dB(DB) of measured parameter Sxy at measurement point n
 Sxy. sec(n) : Imaginary part(RI) or phase(MA,DB) of measured parameter Sxy at measurement point n
 N : Number of measurement points
 : Tab
 : Line break

e5070bue9002

Figure 10-6 3-port Touchstone file

```

Data
Freq (1)  Saa. pri (1)  Saa. sec (1)  Sab. pri (1)  Sab. sec (1)  Sac. pri (1)  Sac. sec (1) 
 Sba. pri (1)  Sba. sec (1)  Sbb. pri (1)  Sbb. sec (1)  Sbc. pri (1)  Sbc. sec (1) 
 Sca. pri (1)  Sca. sec (1)  Scb. pri (1)  Scb. sec (1)  Scc. pri (1)  Scc. sec (1) 
Freq (2)  Saa. pri (2)  Saa. sec (2)  Sab. pri (2)  Sab. sec (2)  Sac. pri (2)  Sac. sec (2) 
 Sba. pri (2)  Sba. sec (2)  Sbb. pri (2)  Sbb. sec (2)  Sbc. pri (2)  Sbc. sec (2) 
 Sca. pri (2)  Sca. sec (2)  Scb. pri (2)  Scb. sec (2)  Scc. pri (2)  Scc. sec (2) 
:
:
Freq (N)  Saa. pri (N)  Saa. sec (N)  Sab. pri (N)  Sab. sec (N)  Sac. pri (N)  Sac. sec (N) 
 Sba. pri (N)  Sba. sec (N)  Sbb. pri (N)  Sbb. sec (N)  Sbc. pri (N)  Sbc. sec (N) 
 Sca. pri (N)  Sca. sec (N)  Scb. pri (N)  Scb. sec (N)  Scc. pri (N)  Scc. sec (N) 
    
```

a - c : Selected test port number (corresponding in ascending order, beginning with 1 to a)
 Freq(n) : Frequency at measurement point n [Hz]
 Sxy. pri(n) : Real part(RI), linear magnitude(MA) or dB(DB) of measured parameter Sxy at measurement point n
 Sxy. sec(n) : Imaginary part(RI) or phase(MA,DB) of measured parameter Sxy at measurement point n
 N : Number of measurement points
 : Tab
 : Line break

e5070bue9003

Figure 10-7 4-port Touchstone file

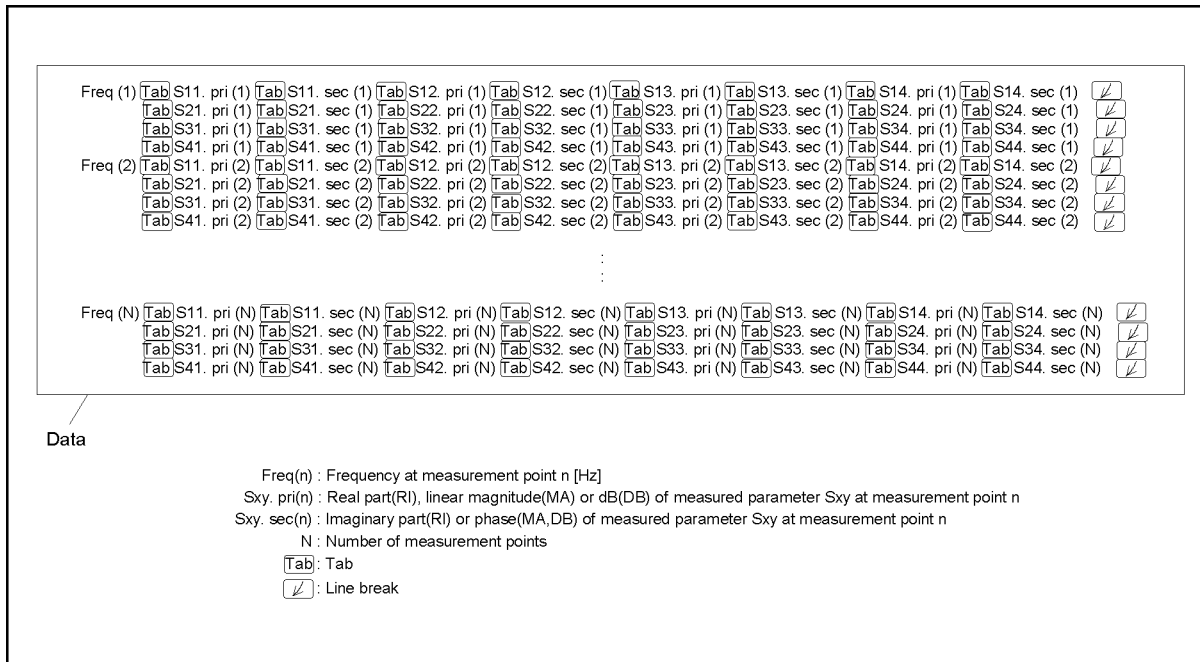

e5070bue9004

Restrictions when saving data in Touchstone format

The following restrictions apply when saving measurement data into Touchstone format.

- When both fixture simulation and port impedance conversion are on, all Z0 of the ports to be saved must be set to the same value. If Z0 is different among the ports, no error occurs, but only the Z0 of the smallest port number is output to the header.
- When the time domain function is on, the saved data are not the displayed data but the data of the S parameter before conversion.
- For data saved in touchstone format, data operation, time domain, parameter conversion, data format, and smoothing are not reflected in the output data.
- An error occurs when attempting to save data that use the frequency offset function.

Saving procedure

Follow the steps below to save trace data in Touchstone format.

- Step 1.** Press **Channel Next** or **Channel Prev** to activate a channel in which a trace exists to be saved.
- Step 2.** Press **Save/Recall**.
- Step 3.** Press **SnP - SnP Format**.
- Step 4.** Press the softkey that corresponds to the data format you want to save.

Softkey	Function
Auto	Data format is automatically set according to the display format of the active trace.*1

Softkey	Function
LogMag/Angle	Select “log magnitude - angle” data format
LinMag/Angle	Select “linear magnitude - angle” data format
Real/Imaginary	Select “real - imaginary number” data format

*1. When the display format of the active trace is set to one other than log magnitude format (LogMag), linear magnitude format (LinMag), or real-imaginary number format (Real/Imag), the data format is automatically set to real-imaginary number.

- Step 5.** Press the softkey for **s1p**, **s2p**, **s3p**, or **s4p** according to the file type you want to save.
- Step 6.** Press the softkey that corresponds to the combination of ports that you want to save. For example, when pressing **s3p** in Step5, softkeys displayed are **1-2-3**, **1-2-4**, **1-3-4**, and **2-3-4**. If you want to save the data of the channel for which port 1, port 2, and port 4 are measured, press **1-2-4**.
- Step 7.** SaveAs dialog box opens. For its operations, use an external keyboard and mouse. For Save As dialog box, refer to Figure 10-1, “Save As dialog box,” on page 355.
- Step 8.** Specify the folder to which the file should be saved, enter a file name, and then press **Save** to save the file.

NOTE

When saving data in a sweep process, the data during sweep is saved into a Touchstone file. That is, the previous sweep data is saved as data that has not been swept; or, if sweep was not performed previously, zero data might be saved. Therefore, you should set the active channel to the HOLD state when saving data into a Touchstone file.

Saving the Screen Image to a File

Along with printing, the E5070B/E5071B allows the user to save screen images as bitmap (.bmp) or portable network graphics (.png) files. Saved files can be loaded into PC application software for further processing.

Saving the Screen Image to a File

Follow the procedure below to save a screen image to a file.

Step 1. Display the screen to be saved as a file.

NOTE If you want to save the screen with a white background, set the display mode to inverted display before saving the screen. For details about display mode, see “Selecting display mode” on page 91.

Step 2. Press **System** to display the System menu. Use the softkey listed below.

Softkey	Function
Dump Screen Image	Saves the screen image to a file

NOTE The screen image at the time **System**^{Capture} is pressed is the image that will be saved. For details, see “Printed/saved images” on page 370.

Step 3. Press **Dump Screen Image** to open the Save As dialog box. For more information on the Save As dialog box, see the descriptions associated with Figure 10-1, “Save As dialog box,” on page 355. Note that “Bitmap Files (*.bmp)” or “Portable Network Graphics (*.png)” is selected as the file type when the dialog box first opens.

Step 4. Select the file type.

Step 5. Select the destination folder and type a file name. Press **Save** to save the screen image of E5070B/E5071B to a file.

Organizing Files and Folders

You can organize files and folders (copy, move, delete, rename, or format a floppy disk) with Windows® Explorer®.

Figure 10-8

Windows Explorer

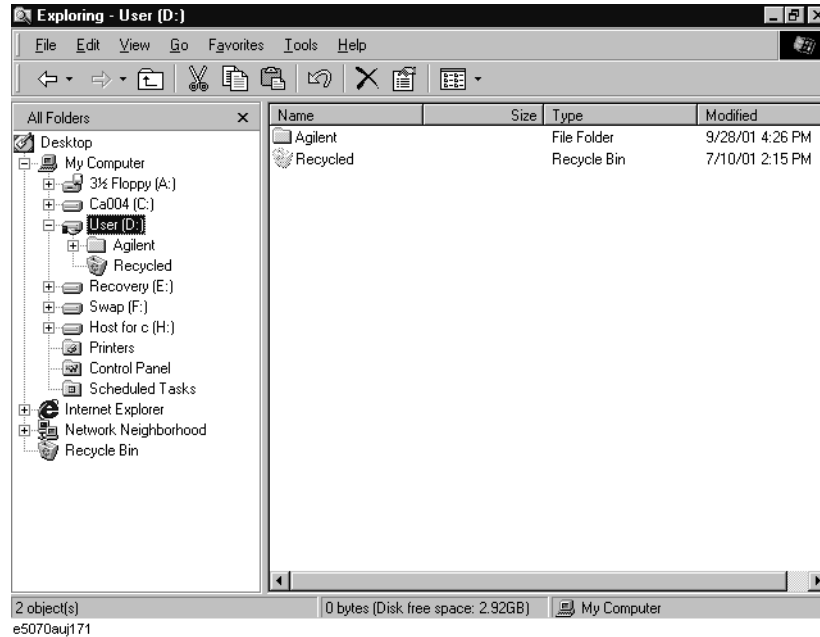

NOTE

Do not modify any files and folders in drives other than drive A: and drive D:. Doing so will cause malfunctions.

To Open Windows Explorer

Step 1. Press **Save/Recall**.

Step 2. Press **Explorer...**

To Copy a File or Folder

Step 1. Select a source file or folder in Windows Explorer.

Step 2. Select **Edit - Copy** from the menu bar.

Step 3. Open the destination folder.

Step 4. Select **Edit - Paste** from the menu bar.

To Move a File or Folder

- Step 1.** Select a source file or folder in Windows Explorer.
- Step 2.** Select **Edit - Cut** from the menu bar.
- Step 3.** Open the destination folder.
- Step 4.** Select **Edit - Paste** from the menu bar.

To Delete a File or Folder

- Step 1.** Select a file or folder you want to delete in Windows Explorer.
- Step 2.** Select **Edit - Delete** from the menu bar.

To Rename a File or Folder

- Step 1.** Select a file or folder you want to rename in Windows Explorer.
- Step 2.** Select **File - Rename** from the menu bar.
- Step 3.** Type the new name of the file or folder and then press .

To Format a Floppy Disk

NOTE

All files and folders in the floppy disk are erased by formatting.

- Step 1.** Put a floppy disk into the floppy disk drive that you want to format.
- Step 2.** Use the right mouse button to click the A drive in Windows Explorer.
- Step 3.** Click **Format...** in the shortcut menu.
- Step 4.** Follow the instructions in the dialog box to format the floppy disk.

Printing Displayed Screen

By connecting a printer to the parallel port or USB port of the E5070B/E5071B, you can print the displayed screen of the E5070B/E5071B.

Supported printers

For the latest information of the supported printers for the E5070B/E5071B, refer to “Printer Compatibility“ of http://www.agilent.com/find/ena_support/.



NOTE

The drivers for all supported printers at the time of shipment are installed in the E5070B/E5071B. If you use a printer newly supported after purchasing the product, you need to install the printer driver for the printer in the E5070B/E5071B.

Printed/saved images

The display image saved in the volatile memory (clipboard) is printed/saved. If no image is saved in the clipboard, the image displayed at the time of print execution is printed/saved.

Saving image to clipboard

 also has a screen capture feature. When you press , the image displayed on the screen immediately before pressing is saved in the clipboard.

NOTE

The image in the clipboard is cleared when you execute print/save.

Print Procedure

Preparation before printing

Follow these steps to prepare for printing:

- Step 1.** Turns off the E5070B/E5071B.
- Step 2.** Turn on the printer and connect it to the E5070B/E5071B.

NOTE

Do not connect a printer that is not supported to the E5070B/E5071B.

- Step 3.** Turn on the E5070B/E5071B.
- Step 4.** Press .
- Step 5.** Press **Printer Setup**. The Printers window (Figure 10-9) opens. The icons of the printers that have been connected are displayed in the window. When you connect a print for the first time, it is automatically registered and its icon is added in the window. Figure 10-9 shows an example of a Printers window that displays the icons of the HP Deskjet 930C and the HP Deskjet 940C.

Figure 10-9

Printers window

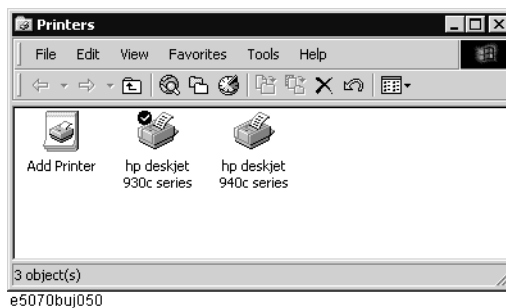

Step 6. The printer with the check mark (☑) on its icon is selected as the default printer for printing. If you want to change it, select (highlight) the icon of your preferred printer in the Printers window and then click **Set as Default Printer** (1 in Figure 10-10) in the File menu.

Figure 10-10 File menu in Printers window

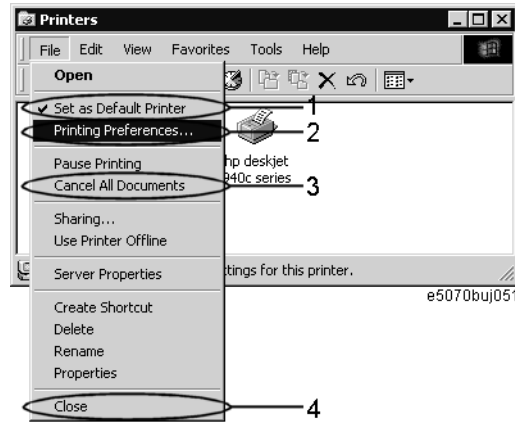

Step 7. Click **Printing Preferences...** (2 in Figure 10-10) in the File menu. The Printing Preferences dialog box for the selected printer appears. Set items necessary before printing such as Page Size (1 in Figure 10-11) and then click the **OK** button (2 in Figure 10-11).

NOTE For information on the Printing Preferences dialog box, refer to your printer's manual.

Figure 10-11 Printing Preferences dialog box (for HP Deskjet 930C)

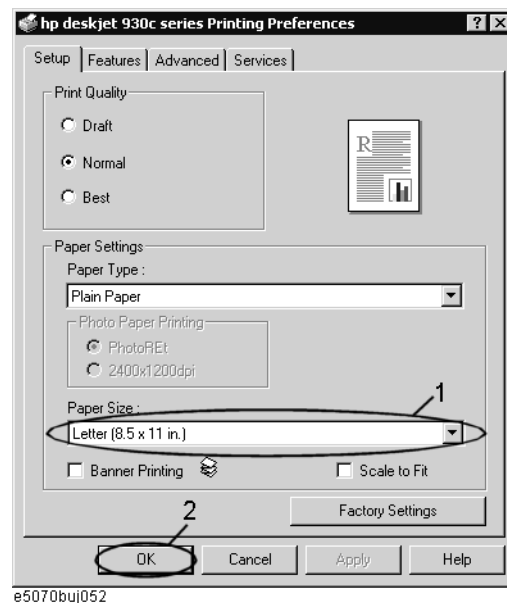

Step 8. Click **Close** (4 in Figure 10-10) in the File menu.

Data Output

Printing Displayed Screen

Executing print

Follow these steps to print the screen information:

- Step 1.** Display the screen you want to print.
- Step 2.** Press  to save the currently displayed screen onto the clipboard.
- Step 3.** As necessary, press **Invert Image** to toggle between [OFF] for printing in colors close to the actually displayed screen and [OFF] for printing in inverse colors.
- Step 4.** Press **Print** to start printing.

To cancel the printing in progress, press **Abort Printing**.

NOTE

If you start printing when the printer is not ready (for example, it is not turned on) by mistake, the Printers Folder dialog box shown in Figure 10-12 may appear. In this case, click **Cancel** to close the Printers Folder dialog box, prepare your printer, and then start printing again.

Figure 10-12

Printers Folder dialog box

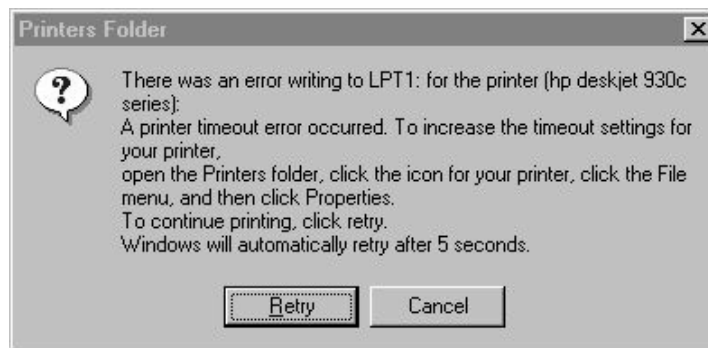

11 Limit Test

This chapter describes the concepts behind the limit test , the ripple test, and the bandwidth test. It also explains how to perform it using the Agilent E5070B/E5071B.

Limit Test

The limit test feature allows you to set the limit line for each trace and then perform the pass/fail judgment for the measurement result.

Concept of limit test

The limit test is a function to perform pass/fail judgment based on the limit line you set with the limit table.

In the limit test, if the upper limit or lower limit indicated by the limit line is not exceeded, the judgment result is pass; if it is exceeded, the judgment result is fail for all measurement points on the trace. Measurement points in a stimulus range with no limit line are judged as pass.

NOTE

The targets of the pass/fail judgment are measurement points only. Parts interpolated between measurement points are not judged.

You define the limit line by specifying the stimulus value (Begin Stimulus) and response value (Begin Response) of the begin point, the stimulus value (End Stimulus) and response value (End Response) of the end point, and the type (lower limit/upper limit). For more information, refer to “Defining the limit line” on page 376.

When the limit test is on, measurement points that fail are displayed in red on the screen and the trace’s pass/fail judgment result based on the results of individual measurement points (fail if one or more measurement points on the trace fail) is also displayed. You can check the pass/fail judgment result for the channel (fail if one or more traces fail in any of the limit test, the ripple test or the bandwidth test within the channel) on the screen as well. For more information, refer to “Displaying judgment result of limit test” on page 375.

In addition to viewing the screen, you can check the judgment result of the limit test by the following methods.

- Beep that occurs when the judgment result is fail.
- Using the status register (for more information, refer to the Programmer's Guide).

Displaying judgment result of limit test

Judgment result of measurement points and trace

Measurement points that fail are displayed in red on the screen. The judgment result of the trace is indicated by Pass or Fail displayed in the upper right part of the graph.

Figure 11-1

Result display of measurement points and trace

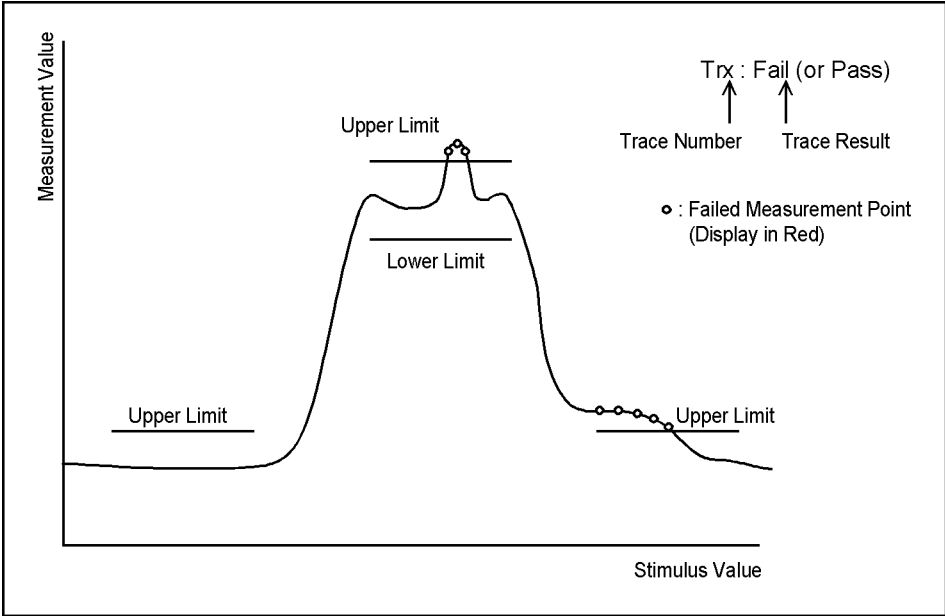

e5070bue064

Judgment result of channels

If a channel has a judgment result of fail, the message shown in Figure 11-2 appears on the screen (it will be judged as failed if one or more unsatisfactory trace exists in any of the limit test, the ripple test or the bandwidth test within the channel.)

Figure 11-2

Channel fail message

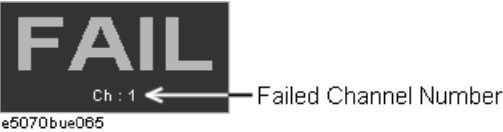

e5070bue065

Follow these steps to turn on/off the display of the channel fail message.

- Step 1. Press **Analysis**.
- Step 2. Press **Limit Test**.
- Step 3. Press **Fail Sign**. Each press toggles between on/off.

Defining the limit line

To use the limit test, you must first define the limit line. You can define a limit table for each trace, and you can define up to 100 limit lines (segments) in a limit table.

Defining a segment

The following steps describe how to define a segment.

- Step 1.** Press **Channel Next** or **Channel Prev** to activate the channel on which the limit test function will be used.
- Step 2.** Press **Trace Next** or **Trace Prev** to activate the trace on which the limit test function will be used.
- Step 3.** Press **Analysis** to display the Analysis menu.
- Step 4.** Press **Limit Test** to display the softkeys associated with the limit test.
- Step 5.** Press **Edit Limit Line** to display the limit table shown in Figure 11-3. Using the limit table, create/edit a segment. Initially, no segments are entered in the limit table.

At the same time, the Edit Limit Line menu used to create/edit the limit table is displayed. The following lists the functions that correspond to the softkeys shown.

Softkey	Function
Delete	Deletes the segment containing the selected cell from the limit table.
Add	Adds a segment before the segment containing the selected cell to the limit table.
Clear Limit Table	Clears all of the limit table data.
Export to CSV File	Exports the limit table to a file in CSV (comma-separated value) format. For more information, see “Saving/calling the limit table” on page 379.
Import from CSV File	Imports a limit table saved in CSV (separated-separated value) format. For more information, see “Saving/calling the limit table” on page 379.
Return	Exits the Edit Limit Line menu and closes the limit table display.

Figure 11-3

Limit table

Segment number	Type of limit line	Beginning point of stimulus value	End point of stimulus value	Beginning point of response value	End point of response value
1	2	3	4	5	6
1	MAX	1.000000000 MHz	3.000000000 MHz	-10 dB	-20 dB
2	MAX	4.000000000 MHz	5.000000000 MHz	-30 dB	-30 dB
3	MIN	4.000000000 MHz	5.000000000 MHz	-50 dB	-50 dB
4	MAX	6.000000000 MHz	8.000000000 MHz	-20 dB	-10 dB
5	OFF	8.000000000 MHz	10.000000000 MHz	-10 dB	-10 dB
6					

e5070aue064

Step 6. Press Add to add a segment to the limit table and then specify the segment parameter values shown below.

Segment Parameter	Description
Type	Select the type of segment from the following: OFF Segment not used for the limit test MIN Segment at which the minimum is specified MAX Segment at which the maximum is specified
Begin Stimulus *1*2	Specify starting point for stimulus value on the limit line
End Stimulus *1*2	Specify ending point for stimulus value on the limit line
Begin Response *3*4	Specify starting point for response value on the limit line
End Response *3*4	Specify ending point for response value on the limit line

*1. The range in which stimulus values can be specified is from -500 G to +500 G. When a value outside the range is entered, a suitable value within the range is specified.
 *2. Once the stimulus value is specified, changing the sweep range of the E5070B/E5071B does not affect the stimulus value.
 *3. The range in which response values can be specified is from -500 M to +500 M. When a value outside this range is entered, a suitable value within the range is specified.
 *4. After the response value is specified, changing formats results in changing the units but not the value.

Figure 11-4

Example of limit lines (when limit table is set as Figure 11-3)

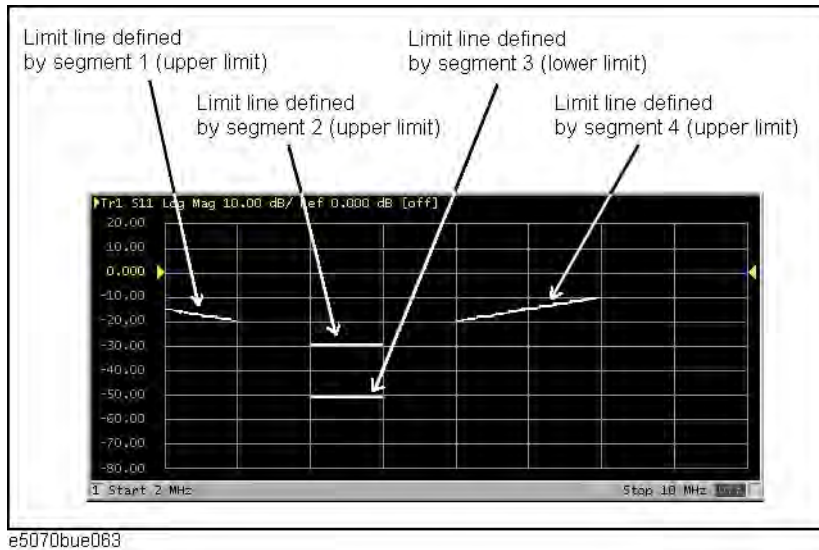

NOTE

You can define a limit line that is able to freely overlap the stimulus range of another limit line.

Defining one limit line having the same type as a second limit line whose stimulus range overlaps with the first one results in two or more limit values at the same measurement point. In this case, the limit value to be used in the limit test is defined as follows:

- When two or more limit values whose type is set to maximum (MAX) exist, the smallest one is used as the maximum.
- When two or more limit values whose type is set to minimum (MIN) exist, the largest one is used as the minimum.

NOTE

Even if the span of the sweep range on the E5070B/E5071B is set to 0, enter the two parameters of Begin Stimulus and End Stimulus.

NOTE

When two or more response values are returned as a result of using the Smith or polar chart format, the first response value of the marker provides the object of the limit test.

Saving/calling the limit table

You can save the limit table to a file that you can then freely bring up on the screen later and use. You can import a file saved in CSV format (extension: *.csv) into spreadsheet software on a PC for later use (a numerical value will be saved as strings that include its unit).

The limit table is saved in the following format.

Example 11-1

Limit Table Saved in CSV Format

```
"# Channel 1"
"# Trace 1"
Type, Begin Stimulus, End Stimulus, Begin Response, End Response
MAX, 200.0000000 MHz, 400.0000000 MHz, -100 dB, -100 dB
MAX, 490.0000000 MHz, 510.0000000 MHz, -10 dB, -10 dB
MIN, 490.0000000 MHz, 510.0000000 MHz, -20 dB, -20 dB
MIN, 600.0000000 MHz, 800.0000000 MHz, -100 dB, -100 dB
```

On the first line, the channel number of the active channel that was valid when the file was saved is output.

On the second line, the trace number of the active trace that was valid when the file was saved is output.

The third line provides the header showing the items for the segments to be output on the fourth and later lines.

Data on segments are output on the fourth and later lines.

Saving/calling the limit table

The following steps describe how to save/call the limit table. Use the external keyboard and mouse for the operations listed below.

- Step 1.** Display the limit table.
- Step 2.** In the Edit Limit Line menu, press **Export to CSV File** to open the Save As dialog box. For more information on the Save As dialog box, refer to the description provided in Figure 10-1, "Save As dialog box," on page 355. In this step, CSV (extension: *.csv) is selected as the file type.
- Step 3.** Specify the folder in which to save the file and enter the file name. Press **Save** to save the limit table displayed on the screen to the file.
- Step 4.** Conversely, to recall a saved limit table, press **Import from CSV File** in the Edit Limit Line menu to display the Open dialog box. For a description of the parts of the Open dialog box, see Figure 10-3, "Open dialog box," on page 357. In this step, CSV (extension: *.csv) is selected as the file type.
- Step 5.** After specifying the folder containing the file, select the file. Press **Open** to display the limit table on the screen.

NOTE

The limit table can be called from any trace of any channel, regardless the channel or trace as of saving in a file.

Limit Test

Limit Test

Turning the limit test ON/OFF

You can set the limit test ON/OFF for each trace individually.

Setting the limit test ON/OFF

The following steps explain how to set the limit test ON/OFF.

- Step 1.** Press **Channel Next** or **Channel Prev** to activate the channel on which the limit test function will be used.
- Step 2.** Press **Trace Next** or **Trace Prev** to activate the trace on which the limit test function will be used.
- Step 3.** Press **Analysis** to display the Analysis menu.
- Step 4.** Press **Limit Test** to display the Limit Test menu.

Softkey	Function
Limit Test	Sets the limit test ON/OFF.
Limit Line	Sets the limit line display ON/OFF.
Edit Limit Line	Opens the limit table for editing the limit line. *1

*1. To use the limit test function, you must first define the limit line. For more on how to define the limit line, see “Defining the limit line” on page 376.

- Step 5.** Press **Limit Test** to turn the limit test ON. To display the limit line on the screen, press **Limit Line**.

Limit line offset

By adding a certain offset to the limit value, you can adjust the limit line so that it conforms to the device output.

- Step 1.** Press **Channel Next** or **Channel Prev** to activate the channel to which you want to apply the limit test function.
- Step 2.** Press **Trace Next** or **Trace Prev** to activate the trace to which you want to apply the limit test function.
- Step 3.** Press **Analysis** to display the Analysis menu.
- Step 4.** Press **Limit Test** to display the softkeys for the limit test.
- Step 5.** Press **Limit Line Offsets** to display the limit line offset function menu. The following functions correspond to each softkey.

Softkey	Function
Stimulus Offset	Adds a certain offset to the stimulus value of the entire segment in the limit table. (Stimulus offset)
Amplitude Offset	Adds a certain offset to the response value of the entire segment in the limit table. (Amplitude offset)
Marker Amp. Ofs.	Adds the amplitude offset by the same amount as the retrieved value of the active marker. You can confirm the current value set for the amplitude offset by pressing Amplitude Offset . (Marker amplitude offset)
Return	Ends the limit line offset menu.

Figure 11-5

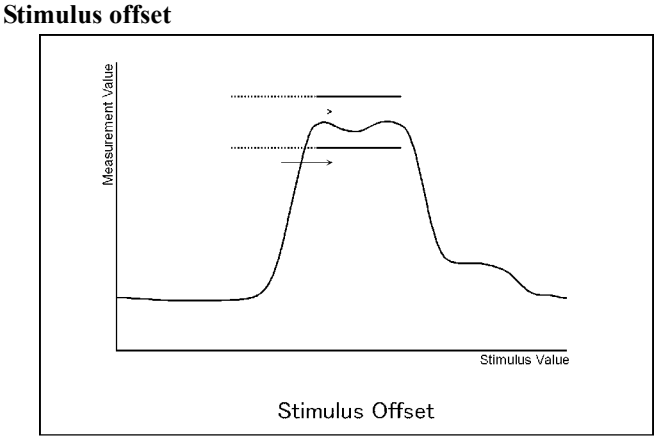

Figure 11-6

Amplitude offset

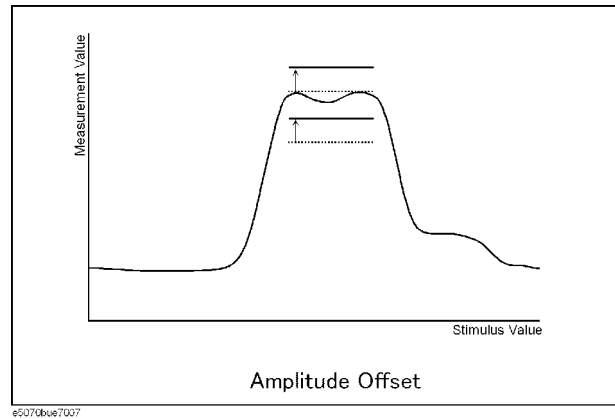
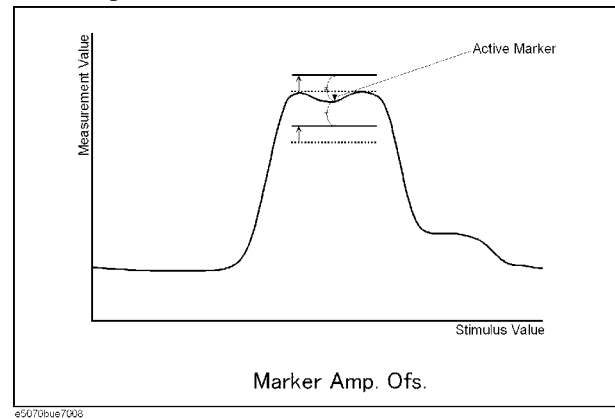

Figure 11-7

Marker amplitude offset



Initializing the limit table

The following operations initialize the limit table.

- At power-on
- When presetting
- When calling a limit table with zero segments
- When **Clear Limit Table - OK** is pressed in the Edit Limit Line menu

Ripple Test

Independently of the limit test, you can evaluate the measurement results on a pass/fail basis by setting a limit for the ripple. This function is called the ripple test.

Concept of ripple test

The ripple test is a function for evaluating the results on a pass/fail basis based on the ripple limit, which is set using the ripple limit table. You can specify up to 12 frequency bands, which permits a test for each frequency band.

The ripple test judges the measurement as "Pass" when the ripple value specified with the ripple limit is not exceeded by any of the measurement points on the trace; otherwise, it judges the measurement as "Fail." For the measurement points in a stimulus range without a specified ripple limit, the test judges the measurement as "Pass."

NOTE

The measurement point alone is the target of evaluation for pass/fail. The interpolated part between measurement points is not evaluated.

The ripple limit is defined with the start point stimulus value, end point stimulus value, ripple limit value, and type (on/off.) For detailed information, see "Configuring ripple limit" on page 385.

While the ripple test function is turned on, the measurement points corresponding to a "fail" judgment will be indicated in red on the screen, and the trace's test results based on the results of each measurement point will be displayed (judged as "fail" if one or more red measurement point exist on the trace). For information on how to display the results, see "Turning on/off ripple test and displaying results" on page 388. You can also confirm the channel test results on the screen (judged as "fail" if one or more failed traces appear in the limit test, ripple test, or bandwidth test within the channel).

Displaying ripple test results

Measurement point and test results

Failed measurement points will be displayed in red on the screen. The test result for the trace will be indicated as Pass or Fail in the upper-right area of the graph. You can also display the ripple value at the selected frequency band.

The result will be displayed as Ripln:Pass (or Fail) for each trace. n denotes the trace number. Bn will be followed by the ripple value (if the ripple display is turned off, only Bn will be displayed without the ripple value).

For example, in Figure 11-8, “Sample ripple test results,” Ripl1:Pass in the first line indicates the result for trace 1. The value following B3 is the ripple value at the third frequency band specified in the ripple test. Similarly, the second line indicates the test result for trace 2, showing the ripple value at the first frequency band.

For information on how to display the results, see “Turning on/off ripple test and displaying results” on page 388.

Figure 11-8

Sample ripple test results



e5070bue7022

Test result for channel

If a channel has a judgment result of “fail,” the message will be displayed as shown in Figure 11-2. (It will be judged as failed if one or more failed traces are found in the limit test, ripple test, or bandwidth test within the channel.)

You can also specify the On/Off setting for the Fail Sign in the limit test menu and as well as in the bandwidth test menu. From the ripple test menu, follow the steps below to turn it on/off.

Step 1. Press **Analysis**.

Step 2. Press **Ripple Limit**.

Step 3. Press **Fail Sign**. This menu toggles between on and off.

In addition to the screen, the following features also let you confirm the test results:

- Beep notifying that the result was “fail”
- Status register (for further information, see the *Programmer's Guide*)

Configuring ripple limit

You must configure the ripple limit before you can use the ripple test function. You can specify a ripple limit table for each trace, where up to 12 ripple limit bands (frequency bands) can be configured.

Operational procedure

Follow the steps below to configure the ripple limits.

Step 1. Press **Channel Next** or **Channel Prev** to activate the channel to which you want to apply the ripple test function.

Step 2. Press **Trace Next** or **Trace Prev** to activate the trace to which you want to apply the ripple test function.

Step 3. Press **Analysis** to display the Analysis menu.

Step 4. Press **Ripple Limit** to display the softkeys for to the ripple test.

Step 5. Press **Edit Ripple Limit** to display the ripple limit table shown in Figure 11-9 on page 386, and create or edit the bands. Note that no frequency band is provided in the ripple limit table by default. The **Edit Ripple Limit** menu is also displayed, which can be used for creating or editing the frequency band. The following are functions corresponding to each softkey.

Softkey	Function
Delete	Deletes the frequency band with the selected cell in the ripple limit table.
Add	Adds a frequency band ahead of the one for the selected cell in the ripple limit table.
Clear Limit Table	Clears all of the data within the ripple limit table.
Export to CSV File	Outputs the ripple limit table to a file in the csv format. For further information, see “Saving/recalling ripple limit table” on page 387.
Import from CSV File	Calls the ripple limit table saved in the csv format. For further information, see “Saving/recalling ripple limit table” on page 387.
Return	Ends the Edit Ripple Limit menu to close the ripple limit table.

Limit Test
Ripple Test

Figure 11-9

Ripple limit table

	Type	Begin Stimulus	End Stimulus	Max Ripple
1	ON	933.0000000 MHz	964.0000000 MHz	1.5 dB
2	ON	938.0000000 MHz	953.0000000 MHz	500 mdB
3	ON	953.0000000 MHz	960.0000000 MHz	300 mdB
4				

e5070bue7018

Step 6. Press **Add** to add a frequency band to the ripple limit table and then specify the following parameters for the frequency band:

Parameter	Description
Type	Selects a frequency type, either ON or OFF. ON Band used for the ripple test. OFF Band not used for the ripple test.
Begin Stimulus *1*2	Specifies the start point for the stimulus value in the ripple test.
End Stimulus *1*2	Specifies the end point for the stimulus value in the ripple test.
Max Ripple	Specifies the ripple limit value.

*1. Acceptable range for the stimulus value: -500G to +500G. If any outranging value is specified, it will be reset to fall within the range.

*2. Even if the E5070B/E5071B's sweep range is changed after the stimulus value has been set, the stimulus value is not susceptible.

Figure 11-10

Example of ripple limit configuration (for limit table in Figure 11-9)



NOTE The individual frequency bands for the ripple test can overlap each other; in this case, the ripple limit test is performed for each frequency band.

NOTE Even if the E5070B/E5071B's span value is set to zero, you must enter a parameter for both Begin Stimulus and End Stimulus.

NOTE If the data format is Smith chart or polar, the limit test is performed for the main response value among the two marker response values.

Saving/recalling ripple limit table

The ripple limit table can be saved in a file and recalled later for use on the screen. The file is saved in the csv format (with the extension *.csv), and values are saved as a character string with the unit. The csv formatted file can also be reused in spreadsheet software made for PCs.

The ripple limit table is saved in the following format:

Example 11-2

Sample Ripple Limit Table Saved in CSV Format

```
"# Channel 1"
"# Trace 1"
Type, Begin Stimulus, End Stimulus, MaxRipple
ON, 933.000000 MHz, 964.000000 MHz, 1.5 dB
ON, 938.000000 MHz, 953.000000 MHz, 500 mdB
ON, 953.000000 MHz, 960.000000 MHz, 300 mdB
```

Limit Test

Ripple Test

In the first line, the channel number for the active channel at the time of file saving will be output.

In the second line, the trace number for the active trace at the time of file saving will be output.

The third line is a header indicating the segment items that are output from the fourth line onward.

From the fourth line onward, the segment data are output.

Operational procedure

Follow the steps below to save/recall the ripple limit table. This operation should be done by using the external keyboard and/or mouse.

- Step 1.** Display the ripple limit table.
- Step 2.** Press Export to CSV File from the Edit Ripple Limit menu to open the dialog box. For information on the Save As dialog box, see the description in Figure 10-1, “Save As dialog box,” on page 355. At this time, CSV Files (with the extension *.csv) is selected as the file type.
- Step 3.** Specify any folder in which you want to save the file, and enter the file name. Press **Save** to save the ripple limit table displayed on the screen to a file.
- Step 4.** To recall the saved ripple limit table, press **Import from CSV File** from the Edit RippleLimit menu to display the Open dialog box. For detailed information on each field of the Open dialog box, see Figure 10-3, “Open dialog box,” on page 357. At this time, CSV Files (with the extension *.csv) is selected as the file type.
- Step 5.** Specify the folder that contains the file, and then select the file. Press **Open** to recall the saved limit table on the screen.

NOTE

You can recall a limit table from a trace on any channel independently of the channel and trace that were active when the limit table was saved to the file.

Turning on/off ripple test and displaying results

You can set the limit test ON/OFF for each trace individually.

Operational procedure

Follow the steps below to configure the on/off setting of the ripple test and the display method.

- Step 1.** Press **Channel Next** or **Channel Prev** to activate the channel to which you want to apply the ripple test function.
- Step 2.** Press **Trace Next** or **Trace Prev** to activate the trace to which you want to apply the ripple test function.
- Step 3.** Press **Analysis** to display the Analysis menu.

Step 4. Press **Ripple Limit** to display the Ripple Limit menu.

Softkey	Function
Ripple Test	Sets the ripple test ON/OFF.
Ripple Limit	Sets the ripple limit line display ON/OFF.
Ripple Value	Sets how the ripple values are displayed. Available settings are off, absolute value (difference between maximum and minimum values within the band) display, and margin (difference between absolute value of ripple and ripple limit) display.
Ripple Value Band	Selects the band for which you want to display the ripple value.
Edit Ripple Limit	Opens the ripple limit table for editing the ripple limit.* ¹

*1. To use the ripple test function, you must first define the ripple limit. For more on how to define the ripple limit, see “Configuring ripple limit” on page 385.

Step 5. Press **Ripple Test** to turn the ripple test ON. You can display the limit lines on the screen by turning on **Ripple Limit**.

Initializing the limit table

The following operations initialize the limit table.

- At power-on
- When presetting
- When calling a ripple table with zero frequency bands
- When **Clear Limit Table - OK** is pressed in the Edit Ripple Limit menu

Bandwidth Test

The bandwidth test function can be used for testing bandwidth for the band-pass filters.

The bandwidth test finds the peak of a signal in the passband and locates a point on each side of the passband at an amplitude below the peak specified in test setup. The frequency between these two points is the bandwidth of the filter. Then the obtained bandwidth is compared to minimum and maximum allowable bandwidth that you specify beforehand.

Figure 11-11

Bandwidth Test

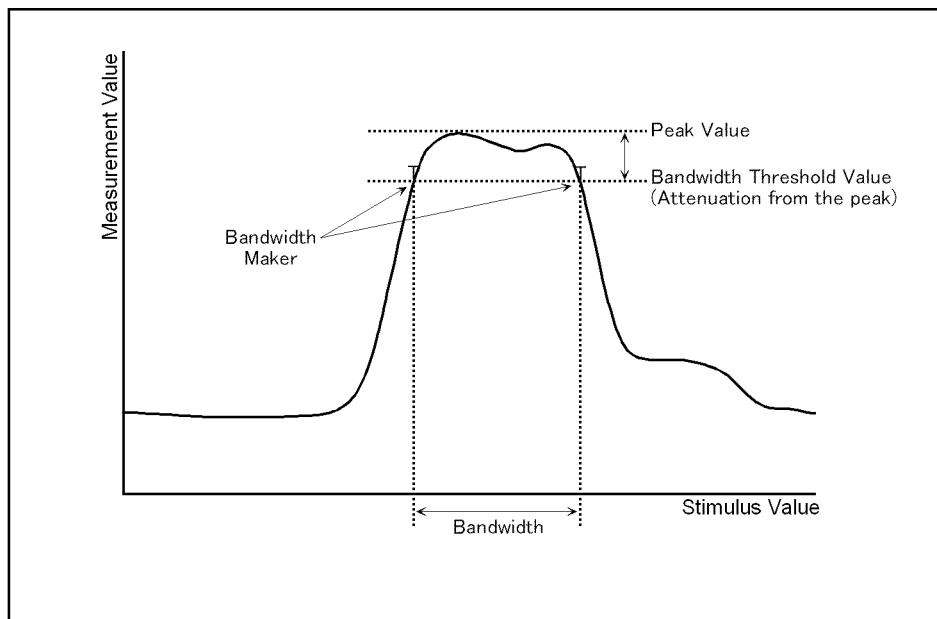

Displaying Bandwidth Test Results

Test Result for Trace

The test result of the trace will be indicated in the upper-right area of the graph for each trace, following BWn: "n" denotes the trace number (see Figure 11-12). The results are shown as Pass, Wide, Narrow, or >Span (Fail). You can also display the bandwidth value.

For information on how to display the results, see “Turning On/Off Bandwidth Test and Displaying Results” on page 392.

Figure 11-12

Sample Bandwidth Test Results

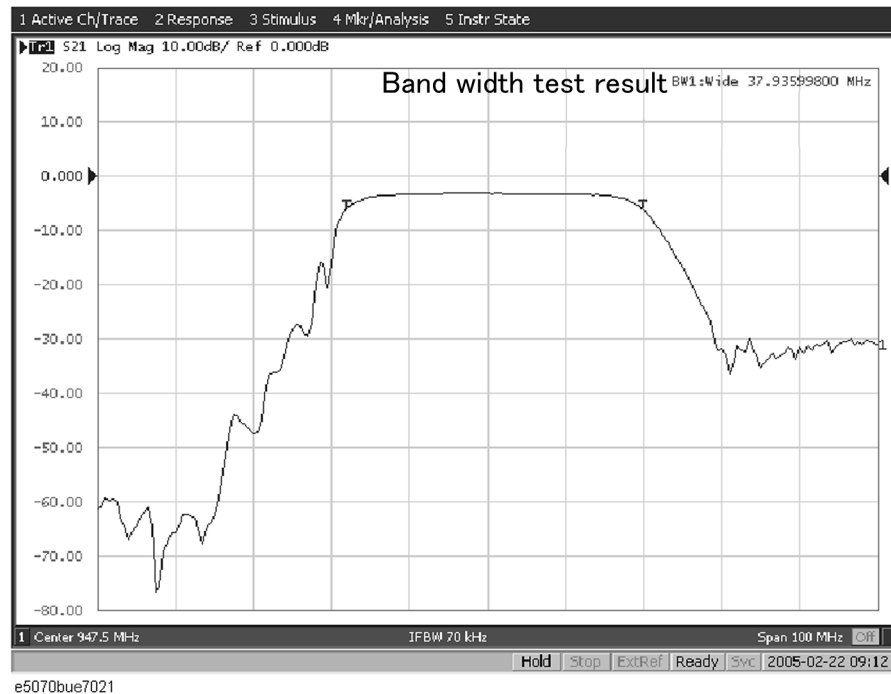

Test Results for Channel

If any channel is unsatisfactory, the message will be displayed as shown in Figure 11-2. (It will be judged as failed if one or more failed traces are found for the limit test, ripple test, or bandwidth test within the channel.)

You can also specify this On/Off setting from the Fail Sign, which is provided in the limit test menu and ripple test menu. From the bandwidth test menu, follow the steps below to turn it on/off.

- Step 1. Press **Analysis**.
- Step 2. Press **Bandwidth Limit**.
- Step 3. Press **Fail Sign**. This menu toggles between on and off.

In addition to the screen, the following features also let you confirm the test results:

- Beep notifying the result was unsatisfactory

Limit Test

Bandwidth Test

- Status register (for further information, see the *Programmer's Guide*)

Set up bandwidth test

You must set up the bandwidth threshold and the upper and lower limits before you can use the bandwidth test function. You can specify the threshold, upper limit, and lower limit for each trace.

Operational procedure

Follow the steps below to set up the bandwidth test.

- Step 1.** Press **Channel Next** or **Channel Prev** to activate the channel to which you want to apply the bandwidth test function.
- Step 2.** Press **Trace Next** or **Trace Prev** to activate the trace to which you want to apply the bandwidth test function.
- Step 3.** Press **Analysis** to display the Analysis menu.
- Step 4.** Press **Bandwidth Limit** to display the softkeys for the bandwidth test.
- Step 5.** Press **N dB Points** to specify the bandwidth threshold. The unit is dB.
- Step 6.** Press **Min Bandwidth** to enter the lower limit for the bandwidth. Similarly, press **Max Bandwidth** to enter the upper limit for the bandwidth. The unit is Hz for both Min and Max bandwidths.

NOTE

If the data format is Smith chart or polar, the limit test is performed for the main response value among the two marker response values.

Turning On/Off Bandwidth Test and Displaying Results

You can configure the on/off setting of the bandwidth test function for each trace independently.

Operational procedure

Follow the steps below to configure the on/off setting of the bandwidth test.

- Step 1.** Press **Channel Next** or **Channel Prev** to activate the channel to which you want to apply the bandwidth test function.
- Step 2.** Press **Trace Next** or **Trace Prev** to activate the trace to which you want to apply the bandwidth test function.
- Step 3.** Press **Analysis** to display the Analysis menu.
- Step 4.** Press **Bandwidth Limit** to display the softkeys for the bandwidth test.
- Step 5.** Press **BW Test** and turn on the bandwidth test. You can display the bandwidth marker on the screen by turning on **BW Marker**. To display the bandwidth value, turn on **BW Display**.

12 Optimizing Measurements

This chapter describes how to optimize your measurements when using the Agilent E5070B/E5071B.

Expanding the Dynamic Range

The dynamic range is the finite difference between the maximum input power level and the minimum measurement power level (noise floor) of the analyzer. In evaluating a characteristic accompanied by a large change in the amplitude (the pass band and stop band of a filter, for example), it is important to increase the dynamic range.

Lowering the receiver noise floor

Lowering the noise floor of the receiver enables you to expand the dynamic range. The following methods can be used to lower the receiver noise floor.

- “Narrowing the IF bandwidth” on page 394
- “Turning on Sweep Averaging” on page 395

Narrowing the IF bandwidth

Narrowing the receiver IF bandwidth enables you to reduce the effect of random noise on measurements. Narrowing the IF bandwidth to 1/10 the original bandwidth causes the receiver noise floor to decrease by 10 dB.

Figure 12-1

Effects of narrowing the IF bandwidth

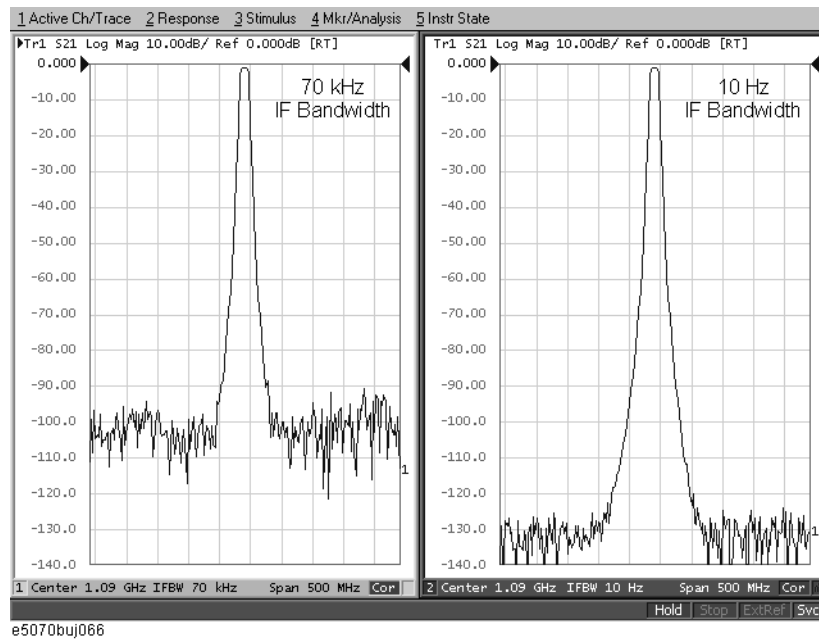

To specify the IF bandwidth, follow the steps described below.

- Step 1.** Press **Channel Next** or **Channel Prev** to select a channel on which to specify the IF bandwidth.
- Step 2.** Press **Avg**.
- Step 3.** Press **IF Bandwidth**.
- Step 4.** Change the IF bandwidth in the data entry area.

Turning on Sweep Averaging

Using sweep averaging also enables you to reduce the effects of random noise on measurements.

Sweep averaging averages data from each point (vector quantity) based on the exponential average of a continuous sweep weighted by the averaging factor specified by the user. Sweep averaging is expressed in Equation 12-1.

Equation 12-1

Sweep Averaging

$$A_n = \frac{S_n}{F} + \left(1 - \frac{1}{F}\right) \times A_{n-1}$$

where:

An = Result of the calculation of sweep averaging for the nth sweep operation at the point in question (a vector quantity)

Sn = Measurement value obtained at the nth sweep operation at the point in question (a vector quantity)

F = Sweep averaging factor (an integer between 1 and 999)

Figure 12-2

Effects of sweep averaging

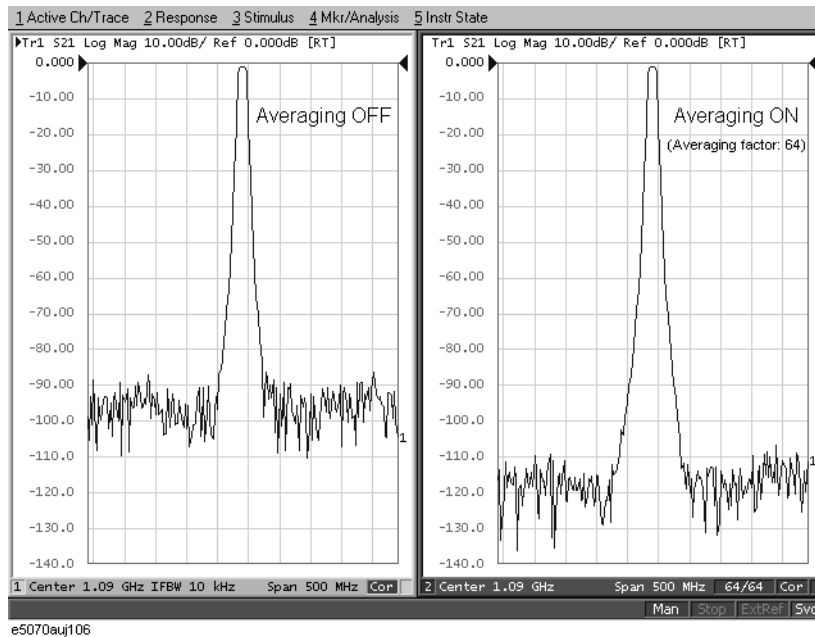

Define the sweep averaging by following the steps below.

- Step 1. Press **Channel Next** or **Channel Prev** to select the channel on which you want to define the sweep averaging.
- Step 2. Press **Avg**.
- Step 3. Press **Avg Factor**.
- Step 4. Change the averaging factor in the data entry area.
- Step 5. Press **Averaging** to turn **ON** the averaging.

NOTE

Pressing **Averaging Restart** resets n to 1 in Equation 12-1 on page 395.

Reducing Trace Noise

Any of the following methods can be used to lower the trace noise.

- Turning on sweep averaging
- Turning on smoothing
- Narrowing the IF bandwidth

For more about sweep averaging and the IF bandwidth, see “Turning on Sweep Averaging” on page 395 and “Narrowing the IF bandwidth” on page 394.

Turning on Smoothing

Smoothing can be used to reduce noise that has relatively small peaks. By turning on smoothing, the value of each point on a trace is represented by the moving average over the values of several nearby points. The smoothing aperture (percentage of sweep span) defines the range of points to be included in the calculation of the moving average.

NOTE You can define the smoothing trace by trace.

Figure 12-3 Effects of smoothing (log magnitude format)

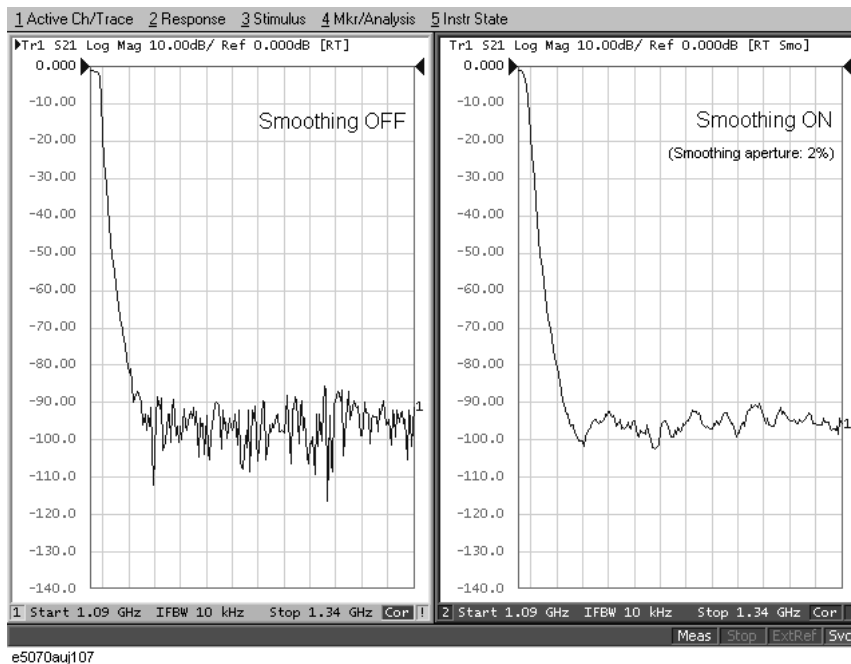
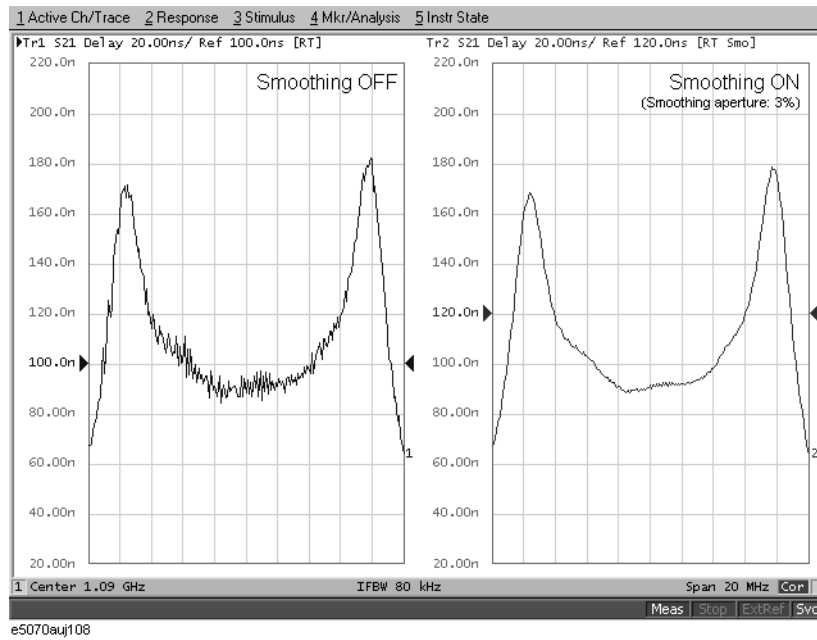

Figure 12-4

Effects of smoothing (group delay format)



12. Optimizing Measurements

Setting up smoothing

Set up the smoothing operation by following the steps below.

- Step 1.** Press **Channel Next** (or **Channel Prev**) and **Trace Next** (or **Trace Prev**) to activate the trace on which smoothing will be defined.
- Step 2.** Press **Avg**.
- Step 3.** Press **Smo Aperture**.
- Step 4.** Change the smoothing aperture (%) in the data entry area.
- Step 5.** Press **Smoothing** to turn **ON** smoothing.

Improving Phase Measurement Accuracy

This section describes the following functions that can be used to improve phase measurement accuracy.

- “Electrical Delay” on page 398
- “Setting port extensions” on page 401
- “Phase offset” on page 400

Electrical Delay

Electrical Delay is a function that adds or removes a pseudo-lossless transmission line with a variable length corresponding to the receiver input. Using this function enables you to improve the resolution in phase measurement and thereby measure deviation from the linear phase. You can specify the electrical delay trace by trace. Depending on the media type, the calculation method of the electrical delay, which is required to correct the phase delay, differs.

Procedure

- Step 1.** Press **Channel Next** (or **Channel Prev**) and **Trace Next** (or **Trace Prev**) to activate the phase trace for which you want to specify the electrical delay.
- Step 2.** Press **Scale**.
- Step 3.** Press **Electrical Delay**.
- Step 4.** Change the electrical delay (in seconds) in the data entry area.
- Step 5.** Press **Media**, and select a media type for calculating the electrical delay. If the electrical delay is 0 second, the calculation result is always the same regardless of media type.

Softkey	Function
Coaxial	Selects Coaxial as the media type.
Waveguide	Selects Waveguide as the media type.

- Step 6.** If you have selected **Waveguide** as the media type, press **Cutoff Frequency**, and specify a cutoff frequency.

NOTE

The cutoff frequency is available only when the media type is **Waveguide**.

For how to determine the deviation from a linear phase, see “Measuring the Deviation from a Linear Phase” on page 505.

Procedure using marker

- Step 1.** Press **Channel Next** (or **Channel Prev**) and **Trace Next** (or **Trace Prev**) to activate the trace for which you want to set the electrical delay.
- Step 2.** Place the active marker in an appropriate position.

Step 3. Press **Marker Fctn**.

Step 4. Press **Marker** → **Delay** to set the electrical delay to the group delay value at the position of the active marker (a value smoothed with the aperture of 20% regardless of the smoothing setting).

NOTE An absolute value is used regardless of the reference marker mode's on/off status.

Phase offset

Phase offset is a function used to add or subtract a predetermined value relative to the frequency to and from the trace. Using this function enables you to simulate the phase offset occurring as a result of, say, adding a cable.

The phase offset can be specified from -360° to $+360^\circ$.

Using the Phase Offset Function

- Step 1.** Press **Channel Next** (or **Channel Prev**) and **Trace Next** (or **Trace Prev**) to activate the trace for which you want to specify the phase offset.
- Step 2.** Press **Scale**.
- Step 3.** Press **Phase Offset**.
- Step 4.** Enter the phase offset ($^\circ$) in the data entry area.

Specifying the velocity factor

The velocity factor is the ratio of the propagation velocity of a signal in a coaxial cable to the propagation velocity of that signal in free space. The velocity factor for a common cable is about 0.66. The propagation velocity depends on the dielectric constant (ϵ_r) of the dielectric substance in the cable.

$$\text{Velocity factor} = \frac{1}{\sqrt{\epsilon_r}}$$

By specifying the velocity factor, you can match the equivalent length (in meters) appearing in the data entry area to the actual physical length when using the “Electrical Delay” on page 398 or “Setting port extensions” on page 401 to specify the electrical delay (in seconds).

You can define the velocity factor channel by channel.

Using the velocity factor

- Step 1.** Press **Channel Next** (or **Channel Prev**) to activate the channel for which you want to specify the velocity factor.
- Step 2.** Press **Cal**.
- Step 3.** Press **Velocity Factor**.
- Step 4.** Enter the velocity factor in the data entry area.

Setting Port Extensions and Loss Values

Setting port extensions

Port Extension is a function for moving the calibration reference plane by specifying the electrical delay. This function is useful, for example, when you cannot directly perform calibration at the DUT terminal because the DUT is inside the test fixture. In such a case, this function enables you to first perform calibration at the test fixture terminal and then move the calibration plane to the DUT terminal by extending the port.

Port extension corrects the electrical delay of each test port (phase shift) only. It cannot remove errors caused by the loss in and incorrect matching of cables, adapters, or test fixtures.

NOTE

You can define port extension channel by channel. Setting port extension for one particular channel does not affect other channels.

Operational procedure

- Step 1.** Press **Channel Next** or **Channel Prev** to activate the channel for which you want to set port extension.
- Step 2.** Press **Cal**.
- Step 3.** Press **Port Extensions**.
- Step 4.** Set port extension for each test port.

Softkey	Function
Extension Port 1	Sets port extension (in seconds) for test port 1.
Extension Port 2	Sets port extension (in seconds) for test port 2.
Extension Port 3 ^{*1}	Sets port extension (in seconds) for test port 3.
Extension Port 4 ^{*2}	Sets port extension (in seconds) for test port 4.

*1. Only with Options 313, 314, 413, and 414.

*2. Only with Options 413 and 414.

Setting loss values

In addition to port extension, you can set loss values for each port. By correcting loss due to port extension, more accurate measurement results are obtained.

There are two types of loss value settings: loss values at two frequency points for a specified port, and a DC loss value. You can make these settings at the same time for each port.

NOTE

You can set loss values channel by channel. Setting loss values for one particular channel does not affect other channels.

1. Setting loss values

- Step 1.** Press or to activate the channel for which you want to set loss values.
- Step 2.** Press .
- Step 3.** Press **Port Extensions**.
- Step 4.** Press **Loss**.
- Step 5.** Press **Select Port** to select the port for which you want to set a loss value.
- Step 6.** Press **Loss1 [OFF]** to toggle to **Loss1 [ON]** (enabled), and enter a loss value (**Loss1**) and a frequency (**Freq1**).
- Step 7.** If you want to set loss at two frequency points, press **Loss2 [OFF]** to toggle to **Loss [ON]** (enabled), and enter a loss value (**Loss2**) and a frequency (**Freq2**).
- Step 8.** If you want to set loss values for other ports, repeat Step 5 to Step 7.

NOTE

When you specify two frequency points, set the lower frequency to Loss1, and the higher one to Loss2.

Equation 12-2 **Expression to calculate loss using Loss 1**

$$\text{Loss}(f) = \text{Loss1} \times \sqrt{\left(\frac{f}{\text{Freq1}}\right)}$$

Equation 12-3 **Expression to calculate loss using Loss 1 and Loss 2**

$$\text{Loss}(f) = \text{Loss1} \times \left(\frac{f}{\text{Freq1}}\right)^n$$

$$n = \frac{\log_{10} \left| \frac{\text{Loss1}}{\text{Loss2}} \right|}{\log_{10} \frac{\text{Freq1}}{\text{Freq2}}}$$

2. Setting a DC loss value

- Step 1.** Press **Channel Next** or **Channel Prev** to activate the channel for which you want to set a DC loss value.
- Step 2.** Press **Cal**.
- Step 3.** Press **Port Extensions**.
- Step 4.** Press **Loss**.
- Step 5.** Press **Select Port** to select the port for which you want to set a DC loss value.
- Step 6.** Press **Loss at DC**, and enter a DC loss value.
- Step 7.** If you want to set a DC loss value for other ports, repeat Step 5 to Step 6.

Enabling port extensions and loss values

- Step 1.** Press **Channel Next** or **Channel Prev** to activate the channel for which you want to enable port extensions and loss values.
- Step 2.** Press **Cal**.
- Step 3.** Press **Port Extensions**.
- Step 4.** Turn on **Extensions**.

Using the auto port extension function

The auto port extension function measures port extension and loss values for each port using the OPEN/SHORT standard connected to the port, automatically calculates them, and set them.

When the auto port extension function is completed, the port extensions and loss values are updated to the calculated values.

NOTE You can use both open and short measurement values in the auto port extension function. Note that in this case, the average value of the calculation results is used for updating.

NOTE You can set the auto port extension function channel by channel. Setting the auto port extension function for one particular channel does not affect other channels.

NOTE When the sweep type is power sweep or the frequency offset function is ON, the auto port extension is not available.

1. Selecting a port(s)

Select the port(s) for which you want to use the auto port extension function.

Step 1. Press or to activate the channel for which you want to set auto port extension.

Step 2. Press .

Step 3. Press **Port Extensions**.

Step 4. Press **Auto Port Extension**.

Step 5. Press **Select Ports** to select the port(s) for which you want to use the auto port extension function.

2. Setting frequencies used for calculation

Set the frequency points with which you want to calculate a loss value.

Step 1. Press or to activate the channel for which you want to set auto port extension.

Step 2. Press .

Step 3. Press **Port Extensions**.

Step 4. Press **Auto Port Extension**.

Step 5. Method to set the frequencies used for calculation.

Softkey	Function
Current Span	Executed using the frequency range set currently.
Active Marker	Executed using the frequency at the active marker. *1 In this case, the result is applied to Loss1. Loss2 is ignored.
User Span	Executed using a start value and a stop value you set.

*1. Even if the active marker has been disabled, it is automatically enabled.

Step 6. If you have selected **User Span**, use **User Span Start** and **User Span Stop** to set a start value and a stop value.

NOTE For **Current Span** and **User Span**, a frequency point at 1/4 of the frequency range is set to **Freq1**; a frequency point at 3/4 of the frequency range is set to **Freq2**. (See Figure 12-5.)

NOTE If the setting is not made before starting OPEN/SHORT standard measurement, it does not affect the calculation result.

Figure 12-5 Frequency points in a frequency range (Freq1 and Freq2)

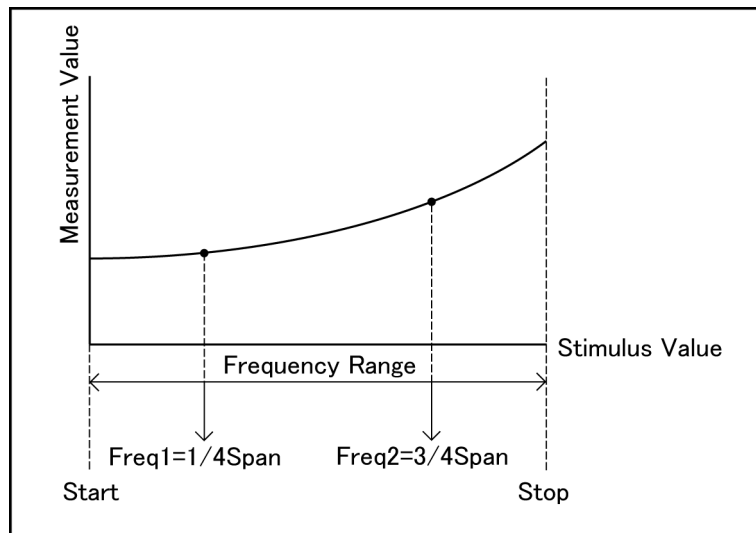

e5070bue8001

Optimizing Measurements

Setting Port Extensions and Loss Values

3. Specifying a loss value as a calculation target

Specify whether you want to include a loss value in the calculation result.

Step 1. Press **Channel Next** or **Channel Prev** to activate the channel for which you want to set auto port extension.

Step 2. Press **Cal**.

Step 3. Press **Port Extensions**.

Step 4. Press **Auto Port Extension**.

Step 5. Press **Include Loss** to turn it on.

Softkey	Function
ON	Calculates a loss value.
OFF	Does not calculate a loss value.

NOTE

If the setting is not made before starting the measurement of the OPEN/SHORT standard, it does not affect the calculation result.

4. Specifying a DC loss value as a calculation target

Specify whether you want to include a DC loss value in the calculation result.

Step 1. Press **Channel Next** or **Channel Prev** to activate the channel for which you want to set auto port extension.

Step 2. Press **Cal**.

Step 3. Press **Port Extensions**.

Step 4. Press **Auto Port Extension**.

Step 5. Press **Adjust Mismatch** to turn it on.

Softkey	Function
ON	Calculates a DC loss value.
OFF	Does not calculate a DC loss.

NOTE

If the setting is not made before starting the measurement of the OPEN/SHORT standard, it does not affect the calculation result.

5. Measuring the OPEN/SHORT standard and executing calculation

Calculate port extensions and loss values based on the calculation results using the OPEN/SHORT standard.

- Step 1.** Press **Channel Next** or **Channel Prev** to activate the channel for which you want to set auto port extension.
- Step 2.** Press **Cal**.
- Step 3.** Press **Port Extensions**.
- Step 4.** Press **Auto Port Extension**.
- Step 5.** If you use the OPEN standard, press **Measure OPEN**, and select the port(s) for which you want to execute measurement. Execution is restricted to ports selected in “1. Selecting a port(s)” on page 404.

Softkey	Function
All	Measures the OPEN standards for all ports selected in “1. Selecting a port(s)” on page 404.
Port 1	Measures the OPEN standard for port 1.
Port 2	Measures the OPEN standard for port 2.
Port 3 ^{*1}	Measures the OPEN standard for port 3.
Port 4 ^{*2}	Measures the OPEN standard for port 4.

- *1. Only with Options 313, 314, 413, and 414.
- *2. Only with Options 413 and 414.

- Step 6.** If you use the SHORT standard, press **Measure SHORT**, and select the port(s) for which you want to execute measurement. Execution is restricted to ports selected in “1. Selecting a port(s)” on page 404.

Softkey	Function
All	Measures the SHORT standards for all ports selected in “1. Selecting a port(s)” on page 404.
Port 1	Measures the SHORT standard for port 1.
Port 2	Measures the SHORT standard for port 2.
Port 3 ^{*1}	Measures the SHORT standard for port 3.
Port 4 ^{*2}	Measures the SHORT standard for port 4.

- *1. Only with Options 313, 314, 413, and 414.
- *2. Only with Options 413 and 414.

NOTE

If a port extension value or loss value has been set, the value is updated to the calculated result.

Optimizing Measurements
Setting Port Extensions and Loss Values

NOTE

If you execute both open measurement and short measurement, the average of the calculation results is reflected to the port extension and loss value.

6. Deleting the result of open/short measurement

When you exit from the softkey menu in the same level after open/short measurement, the measurement results are deleted. Note that you can use a GPIB command.

NOTE

Port extension and loss values that have been calculated are not cleared.

Reducing Measurement Error in High Temperature Environments

The E5070B/E5071B is designed to obtain the best measurement accuracy at the ambient temperature range of $23^{\circ}\text{C} \pm 5^{\circ}\text{C}$. The high temperature measurement mode of the E5070B/E5071B reduces measurement error (drift error) at an ambient temperature of 28°C to 33°C .

NOTE

The high temperature measurement mode must be turned off when the analyzer is used at an ambient temperature below 28°C . Otherwise, the measurement accuracy may be degraded.

Procedure

- Step 1.** Press **System**.
- Step 2.** Press **Service Menu**.
- Step 3.** Press **High Temperature** to turn **ON/OFF** the high temperature measurement mode.

Improving Measurement Throughput

This section explains the following three methods to improve the measurement throughput.

- “Using Fast Sweep Modes” on page 410
- “Turning off the updating of information displayed on the LCD screen” on page 414
- “Turning off system error correction” on page 414

Using Fast Sweep Modes

The E5070B/E5071B provides four sweep modes: “Stepped mode” and “swept mode,” and their accelerated versions “fast stepped mode” and “fast swept mode.” You can shorten sweep time as shown in Table 12-1 by using the swept mode or its fast modes.

NOTE

If it is not necessary to shorten the sweep time, use the stepped mode (preset configuration).

Table 12-1 Sweep time criteria (each measurement point interval)

Measurement point interval	Shorter (faster sweep)		→	Longer (slower sweep)	
2 MHz or less	Swept Fast swept	→		Fast stepped	→ Stepped
2 MHz to 5 MHz	Fast swept	→	Swept	→ Fast stepped	→ Stepped
5 MHz to 8 MHz	Fast swept	→		Swept Fast stepped	→ Stepped
8 MHz to 10 MHz	Fast swept	→		Fast stepped	→ Stepped Swept
10 MHz to 30 MHz	Fast swept	→	Fast stepped	→ Stepped	→ Swept
30 MHz to 50 MHz	Fast swept Fast stepped	→		Stepped	→ Swept
50 MHz to 70 MHz	Fast stepped	→		Fast swept Stepped	→ Swept
70 MHz or more	Fast stepped	→	Stepped	→ Fast swept	→ Swept

Table 12-2 Characteristics of sweep mode

	Stepped	Swept	Fast stepped	Fast swept
Measurement reliability	High	Relatively low	Relatively low	Low
Sweep time	Long (Except when the measurement point interval is approximately 10 MHz or more)	Short (Only when the measurement point interval is approximately 10 MHz or less)	Short (Shortest when the measurement point interval is approximately 30 MHz or more)	Short (Shortest when the measurement point interval is approximately 30 MHz or less)
Restrictions on measurement	No particular restriction	DUTs with long electrical delay cannot be measured correctly	No particular restriction	DUTs with long electrical delay cannot be measured correctly

Swept mode

As shown in Figure 12-6, in the stepped mode, the frequency is changed stepwise and sampling is performed at a fixed frequency for each measurement point. On the other hand, in the swept mode, sampling is performed with the frequency always swept for each measurement point.

NOTE

When the IF bandwidth is 5 kHz or less, the sweep is performed in the stepped mode even if the swept mode has been specified (the fast stepped mode when the fast swept mode is specified).

Figure 12-6

Difference between stepped and swept modes

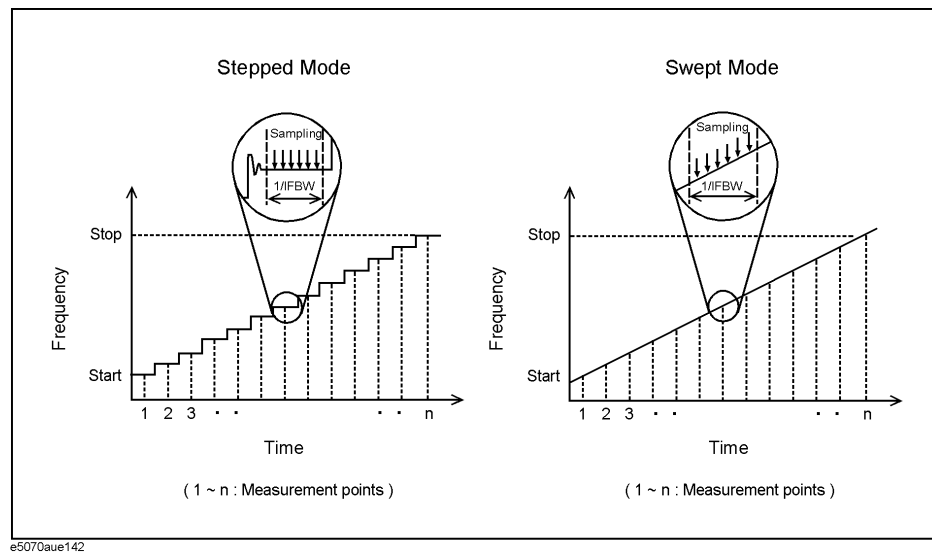

In the stepped mode, a certain time should be allowed until the frequency becomes stable at each measurement point, since the frequency is changed stepwise. Therefore, the sweep time in the swept mode is generally shorter than that in the stepped mode. However, if the measurement point interval is extremely large, the sweep to the next measurement point frequency cannot be completed within the sampling time due to the limitations of the instrument's frequency sweep speed. This causes a certain waiting time until the start of measurement of the next measurement point, and thus in this case the swept mode actually has a longer sweep time.

Although there is some difference depending on the IF bandwidth setting, when the measurement point interval is approximately 10 MHz or less (approximately 30 MHz or less for the fast mode), the sweep time in the swept mode is shorter than that in the stepped mode.

Note that the swept mode has the following disadvantages.

- DUTs with long electrical delay time cannot be measured correctly. For more information, refer to “Notes for measuring DUTs with long electrical delay time” on page 412.
- Trace noise may increase compared to the stepped mode because sampling is performed while sweeping the frequency.
- The specifications are not guaranteed

NOTE

When you use the swept mode, you should confirm that there is no measurement-related

problem before performing the actual measurement.

Notes for measuring DUTs with long electrical delay time

When sweeping the frequency of a signal applied to the DUT (F), there is a frequency difference between the input side and output side of the DUT due to the delay time that occurs in the DUT (ΔT). This frequency difference (ΔF) becomes larger as the electrical delay time of the DUT becomes longer and the frequency sweep speed becomes faster, as shown in the following equation.

$$\Delta F = \frac{dF}{dt} \times \Delta T$$

When measuring a DUT with long electrical delay time, if you perform measurement (sampling) while sweeping the measurement signal as in the swept mode, a measurement error occurs due to the difference between the frequency outputted from the source port and the frequency actually measured at the receiver port. Especially for the fast swept mode, the effect of this error becomes larger due to the faster frequency sweep speed.

Therefore, when measuring a DUT with a long electrical delay time, generally use the stepped mode to prevent the measurement error described above. However, if you need to shorten the sweep time, evaluate the measurement error as described below to determine the sweep mode that should be used.

Procedure to select the fastest possible sweep mode when measuring a DUT with a long electrical delay time

- Step 1.** Perform measurement in both the stepped mode and the fast swept mode.
- Step 2.** Compare the measurement results of the two modes to evaluate the measurement error when using the fast swept mode and determine the sweep mode to use as shown below.

Degree of measurement error		Sweep mode you should use
No problem for required accuracy		Fast swept mode
Problem for required accuracy	Only part of the sweep range	For range with problem: Fast stepped mode For range without problem: Fast swept mode (use segment sweep)
	Entire sweep range	Fast stepped mode

NOTE

By changing the sweep conditions as follows, you can decrease the measurement error when using the fast swept mode. (But these steps increase the measurement time.)

- Narrow the IF bandwidth
- Elongate the sweep time

Fast mode

The fast mode is a sweep mode in which the sweep time is shortened by decreasing the waiting time before sampling (stepped mode) or speeding up the sweep (swept mode) to the limit of the analog performance.

You can always shorten the sweep time by using the fast stepped mode rather than the stepped mode. On the other hand, although there is some difference depending on the IF bandwidth setting, when the measurement point interval is approximately 2 MHz or higher, you can shorten the sweep time by using the fast swept mode rather than the swept mode.

Note that, because the instrument is adjusted to the limit of the analog performance when using the fast mode, a correct measurement may not be obtained due to factors such as increased trace noise, depending on the DUT and measurement conditions. In addition, for the fast mode, the instrument specifications are not guaranteed.

NOTE

When you use the fast mode, you should confirm that there is no measurement-related problem before performing the actual measurement.

Procedure to select the sweep mode

- Step 1.** Press Sweep Setup.
- Step 2.** Press **Sweep Mode**.
- Step 3.** Press the softkey corresponding to the appropriate sweep mode.

Softkey	Function
Std Stepped	Selects the stepped mode
Std Swept	Selects the swept mode
Fast Stepped	Selects the fast stepped mode
Fast Swept	Selects the fast swept mode

Turning off the updating of information displayed on the LCD screen

Turning off the updating of information displayed on the LCD screen eliminates the processing time required to update displays within the analyzer, improving measurement throughput. If it is not necessary to check displayed information during measurements, turning off real-time updating is an effective means of improving throughput.

The updating of information displayed on the LCD screen can be switched using the following procedure:

Turning off the updating of information

- Step 1.** Press **Display**.
- Step 2.** Press **Update** to switch the updating of displayed information on the LCD screen on/off.

When the LCD screen update is turned off, **Update Off** appears on “4. Instrument Status Bar” on page 44.

Turning off system error correction

The E5070B/E5071B executes “IF Range Correction” on page 731 and “Port Characteristics Correction” on page 731 in the data processing flow shown in Figure E-2, “Data Processing Flowchart,” on page 730, by using the system calibration data set at the factory. This system error correction process is not required if the user performs proper calibration by using the **Cal** and the softkeys that subsequently appear, which automatically turns on error correction.

By turning off system error correction, you can reduce the data processing time needed during measurement and thus improve measurement throughput.

NOTE When you turn ON/OFF system error correction, all calibration data set by user calibration is deleted.

Procedure

- Step 1.** Press **System**.
- Step 2.** Press **Service Menu**.
- Step 3.** Press **System Correction**. Figure 12-7 appears.

Figure 12-7

Dialog box for changing system error correction

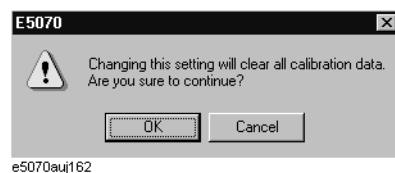

- Step 4.** Press **OK** to turn ON/OFF system error correction.

Performing a Segment-by-Segment Sweep (segment sweep)

This section describes the concept of the segment sweep and how to perform it.

Concept of Segment Sweep

To perform a segment sweep, you must define two or more frequency ranges, called segments, and then specify the number of points, IF bandwidth, power level, sweep mode, sweep delay time, and sweep time for each segment. All segments are swept sequentially as if swept in one sweep operation.

- By skipping the frequency range, which does not need to be measured, you can sweep and measure only the portions you need.
- You can define the optimum measurement conditions for each of the segments you designate. For example, you can specify as many points as possible in a segment requiring high trace resolution and as few points as possible in a segment not requiring high resolution. This shortens the measurement time, enabling you to optimize the overall measurement throughput by not having to perform the entire operation under the same measurement conditions of a particular frequency range.

To evaluate a band pass filter having the transmission characteristics shown in Figure 12-8, for example, you can select the frequency ranges you need from A through G and determine the measurement conditions shown in the Table . This enables you to measure them simultaneously in one sweep operation.

Figure 12-8

Characteristics of a DUT on which a Segment Sweep is to be performed

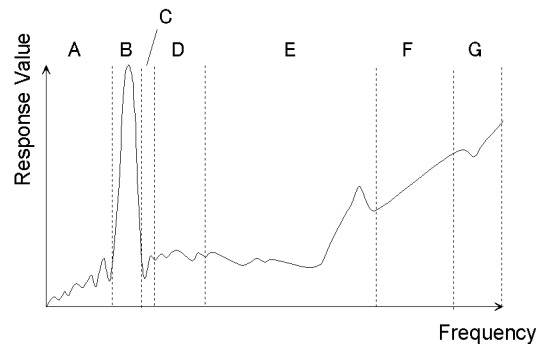

e5070aue097

Table 12-3

Frequency ranges (segments) from Figure 12-8 and their measurement conditions

	Start frequency	Stop frequency	Number of points	IF Bandwidth	Sweep mode
A	440 MHz	915 MHz	50	50 kHz	Stepped
B	915 MHz	980 MHz	130	70 kHz	Fast Stepped
C	980 MHz	1.035 GHz	60	50 kHz	Stepped
E	1.07 GHz	2 GHz	100	70 kHz	Fast Swept
G	2.6 GHz	3 GHz	40	70 kHz	Fast Swept

Conditions for setting up a segment sweep

The following conditions apply when setting up a segment sweep.

- The frequency range of a segment must not overlap with that of another segment. (The start frequency of a segment must be higher than the stop frequency of the immediately preceding segment.)
- The start frequency of segment 1 must be greater than 300 kHz and the stop frequency of the last segment less than 3 GHz (E5070B) or 8.5 GHz (E5071B).
- When the start frequency and stop frequency of a segment are not the same, you can define from 2 to 1601 points in a segment.
- When the start frequency and stop frequency of a segment are the same, you can define from 1 to 1601 points in a segment.
- You can set the total number of points in the segment table from 2 to 1601.
- You can set the number of segments in the segment table to between 1 and 201.

Items that can be set for each segment

For the segment sweep, you can set the sweep range, the number of points, IF bandwidth, power level, sweep delay time, sweep mode, and sweep time for each segment.

You can set the items in the following table to ON/OFF for each segment. If you enable the segment-by-segment setting, you can make the setting for each segment in the segment table; if you disable it, the setting in the following table is used.

Item	When segment-by-segment setting is disabled
IF bandwidth	For all segments, the IF bandwidth for the linear/log sweep (set with <input type="text" value="Avg"/> - IF Bandwidth) is set.
Power level	For all segments, the power level for the linear/log sweep (set with <input type="text" value="Sweep Setup"/> - Power) is set.
Sweep delay time	For all segments, 0 is set.
Sweep mode	For all segments, the sweep mode for the linear/log sweep (set with <input type="text" value="Sweep Setup"/> - Sweep Mode) is set.
Sweep time	For all segments, the auto sweep time mode is set.

Sweep delay time and sweep time in a segment sweep

The definitions for sweep delay time and sweep time, which you can specify in the segment sweep, are shown in Figure 12-9.

Figure 12-9 Sweep delay time and sweep time in segment sweep

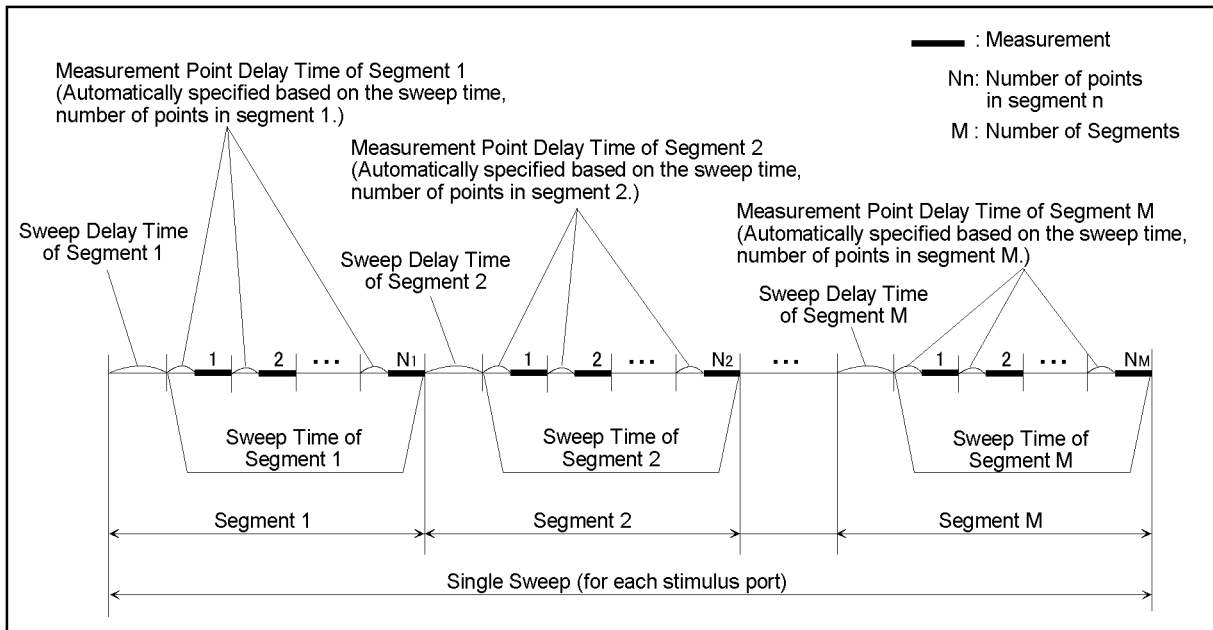

e5070aue098

12. Optimizing Measurements

Frequency base display and order base display

You can choose between frequency-based and order-based display as the method of displaying traces when executing a segment sweep.

Figure 12-10 Concept of segment display

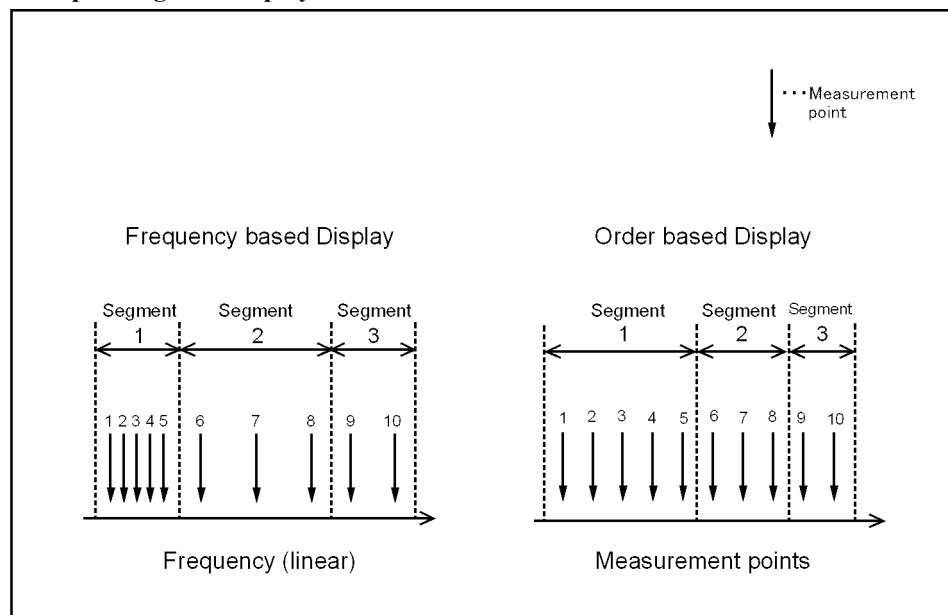

e5070aue105

Optimizing Measurements
Performing a Segment-by-Segment Sweep (segment sweep)

Figure 12-11 Comparison of methods used to displaying segments

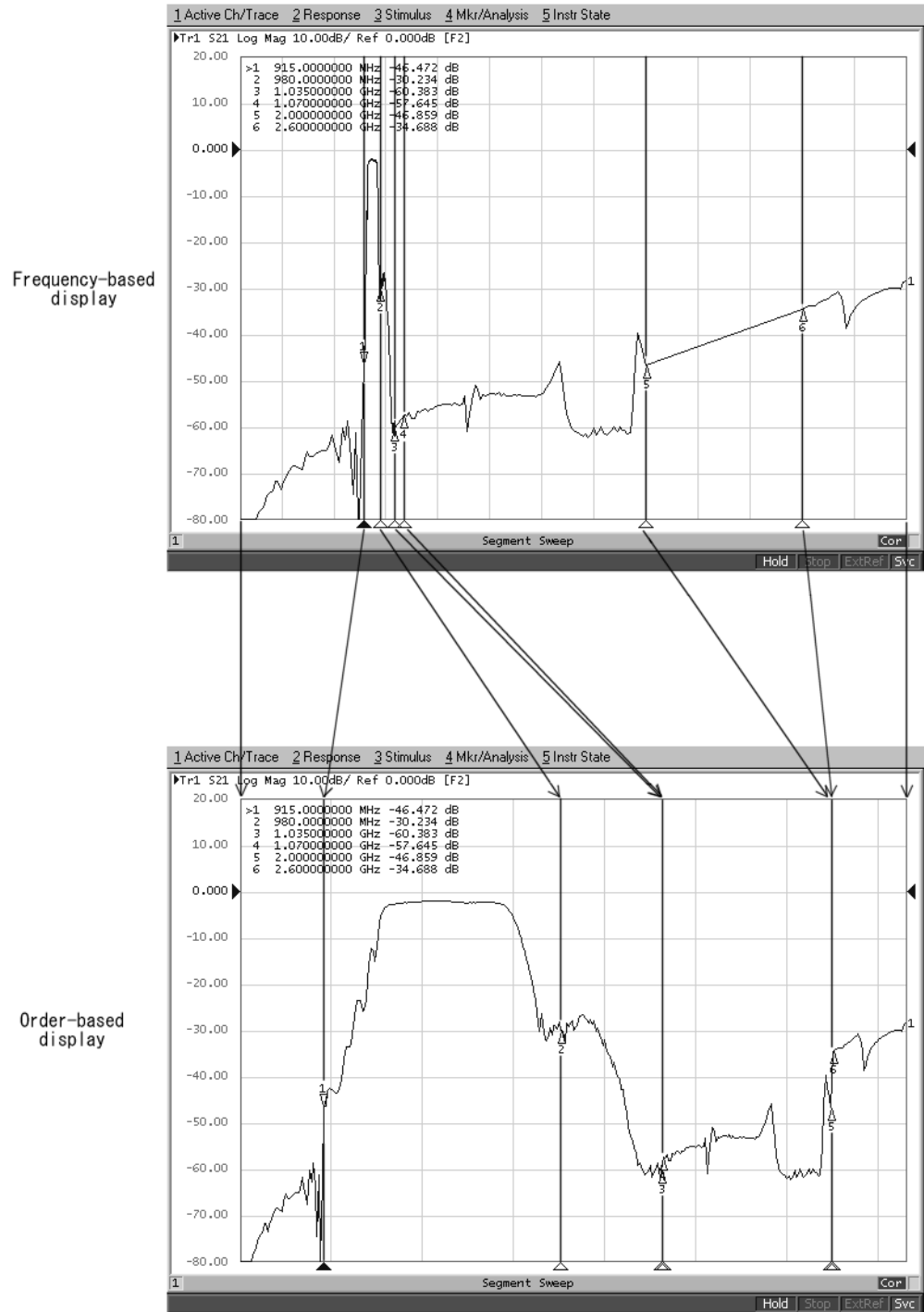

e5070aue103

Procedure

Creating a segment table

Step 1. Press **Channel Next** or **Channel Prev** to select the channel for which you want to create the segment table.

Step 2. Press **Sweep Setup**.

Step 3. Press **Edit Segment Table**.

The segment table appears in the lower part of the screen.

Step 4. To change the frequency range setting mode or to set the IF bandwidth, power level, sweep delay time, sweep mode, and sweep time for each segment, use the following softkeys.

NOTE

When setting the segment table using the front panel keys or keyboard, you need to place focus on (select) the operation target (segment table of softkey) first. You can change the focus by pressing **Focus** in the ENTRY block. When the focus is placed on the segment table, the window frame of the segment table is displayed as bright as the window frame of the active channel. When the focus is placed on the softkey menu, the softkey menu title area is displayed in blue.

Softkey	Function
Freq Mode	Switches the frequency range setting mode (start/stop or center/span)
List IFBW	Toggles ON/OFF the IF bandwidth setting for each segment; the row for setting (IFBW) only appears in the segment table when this is ON
List Power	Toggles ON/OFF the power level setting for each segment; the row for setting (Power) only appears in the segment table when this is ON
List Delay	Toggles ON/OFF the sweep delay time setting for each segment; the row for setting (Delay) only appears in the segment table when this is ON
List Sweep Mode	Toggles ON/OFF the sweep mode setting for each segment; the row for setting (Sweep Mode) only appears in the segment table when this is ON
List Time	Toggles ON/OFF the sweep time setting for each segment; the row for setting (Time) only appears in the segment table when this is ON

Step 5. Enter each item in the following table for each added segment (line) to create the segment table.

Start	Sets the start value of the sweep range
Stop	Sets the stop value of the sweep range
Center	Sets the center value of the sweep range
Span	Sets the span value of the sweep range
Points	Sets the number of points
IFBW	Sets the IF bandwidth
Power	Sets the power level; the power range is common to the settings for the linear/log sweep (Sweep Setup) - Power Ranges)
Delay	Sets the sweep delay time
Sweep Mode	Sets the sweep mode; you need to select one of the following items: STD STEPPED Stepped mode STD SWEPT Swept mode FAST STEPPED Fast stepped mode FAST SWEPT Fast swept mode
Time	Sets the sweep time; to specify the auto setting (AUTO), enter 0 as the sweep time

To create the segment table, use the following keys.



Hardkey	Function
	If you select a cell and then press this key, you enter the mode that allows you to edit the cell character by character. If you change a value and then press this key, the value is entered in the cell.
	Moves up and down in the cell selected in the segment table. In the character-by-character edit mode, you can select an item or perform a stepwise change of data.
	Moves left and right in the cell selected in the segment table.
Softkey	Function
Delete	Deletes the line containing the selected cell.
Add	Adds a new line above the line containing the selected cell.
Clear Segment Table - OK	Resets the segment table. As a result, the initialized segment 1 remains.

Figure 12-12 Example of creating segment table



12. Optimizing Measurements

Useful functions when using a mouse

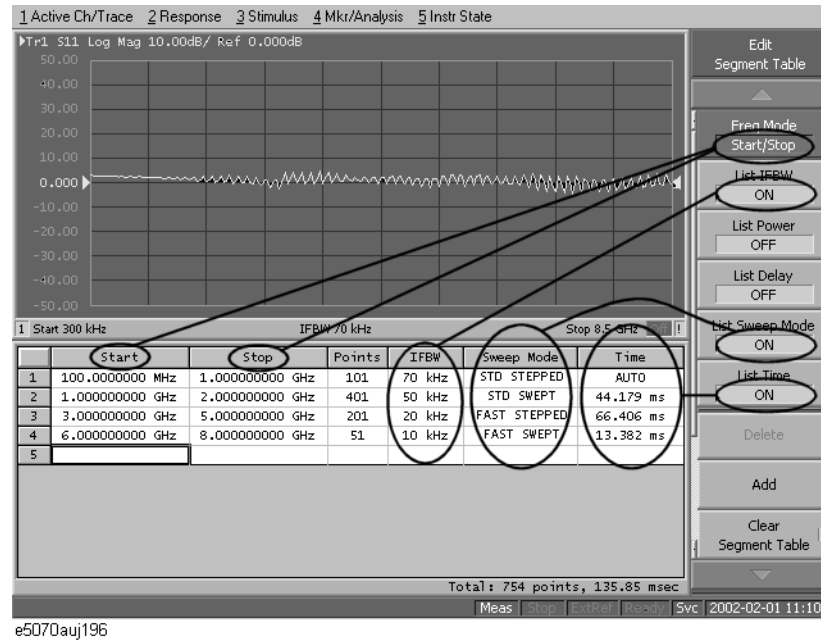
By right-clicking on the selected cell, you can use the following shortcut menu.

Shortcut	Function
Copy	Copies the value in the selected cell into the clipboard (internal temporary storage memory)
Paste	Pastes the value data in the clipboard to a newly selected cell
Insert	Adds a new line above the selected cell
Delete	Deletes the line containing the selected cell

In the character-by-character edit mode, you can also use the following shortcut menu.

Shortcut	Function
Undo	Undoes the change and restore the value before the change
Cut	Cuts the selected string and store it into the clipboard (temporary memory)
Copy	Copies the selected string into the clipboard
Paste	Pastes the string in the clipboard to a newly selected cell
Delete	Deletes the selected string
Select All	Selects the entire string in the cell

Executing segment sweep

To execute a segment sweep by using the segment table you have created, you must specify the sweep type for that sweep operation by following the steps below.

- Step 1.** Press **Channel Next** (or **Channel Prev**) to select the channel on which you will execute the segment sweep operation.
- Step 2.** Press **Sweep Setup**.
- Step 3.** Press **Sweep Type**.
- Step 4.** Press **Segment**.

Setting up the segment display

Define the method of displaying traces when the segment sweep is executed by following the steps described below.

- Step 1.** Press **Channel Next** (or **Channel Prev**) to select the channel on which you will define the segment display.
- Step 2.** Press **Sweep Setup**.
- Step 3.** Press **Segment Display**.
- Step 4.** Select the segment display.

Softkey	Function
Freq Base	Displays the X-axis as the axis for linear frequencies (frequency-based display)
Order Base	Displays the X-axis as the axis for the points (order-based display)

Saving a newly created segment table in CSV format

As discussed in “Creating a segment table” on page 419, you can export the newly created segment table as a CSV (comma-separated value) formatted file (so it can be used easily in software that requires a different format).

- Step 1.** Press **Sweep Setup**.
- Step 2.** Press **Edit Segment Table**.
- Step 3.** Press **Export to CSV File** to open the Save As dialog box. For more information on the Save As dialog box, see Figure 10-1, “Save As dialog box,” on page 355. Note that “CSV Files (*.csv)” will already be selected as the file type when the dialog box first opens.
- Step 4.** Type the file name in the **File Name** area and press **Save** to save the segment table.

Calling a segment table saved in CSV Format

By importing a segment table created following the steps described in “Saving a newly created segment table in CSV format” on page 423 (inputting a file in a different software format), you can set up the segment table.

NOTE

It is possible to recall a file from a different channel where it was saved.

- Step 1.** Press **Sweep Setup**.
- Step 2.** Press **Edit Segment Table**.
- Step 3.** Press **Import from CSV File** to open the Open dialog box. For more information on the Open dialog box, see Figure 10-3, “Open dialog box,” on page 357. Note that “CSV Files (*.csv)” will already be selected as the file type when the dialog box first opens.
- Step 4.** Select the CSV format file to be imported, and press **Open** to call up the segment table.

NOTE

You cannot import a CSV-formatted file created/edited in spreadsheet software into the E5070B/E5071B. Furthermore, you cannot import a CSV-formatted file previously exported following the steps in “Saving a newly created segment table in CSV format” on page 423 if a change has been made to that file.

Optimizing Measurements

Performing a Segment-by-Segment Sweep (segment sweep)

13

Setting and Using the Control and Management Functions

This chapter describes how to set and use the control and management functions not directly linked with measurement or analysis.

Setting the GPIB

This section describes how to set the interface necessary to use the GPIB (General Purpose Interface Bus) of the E5070B/E5071B. For information on the concept and concrete implementation of the auto measurement using GPIB, refer to “Programmers Guide.”

Setting talker/listener GPIB address of E5070B/E5071B

When controlling the E5070B/E5071B using GPIB commands from the external controller connected to the GPIB connector, you need to set the talker/listener GPIB address of the E5070B/E5071B.

Follow these steps to make this setting:

- Step 1.** Press **System**.
- Step 2.** Press **Misc Setup**.
- Step 3.** Press **GPIB Setup**.
- Step 4.** Press **Talker/Listener Address**.
- Step 5.** Enter the address using the ENTRY block keys on the front panel.

Setting system controller (USB/GPIB interface)

When controlling an external device from the E5070B/E5071B, connect the USB port of the E5070B/E5071B and the GPIB port of the external device through the USB/GPIB interface.

Follow these steps to set the USB/GPIB interface:

- Step 1.** Connect the USB port of the E5070B/E5071B to the USB/GPIB interface. The USB/GPIB Interface Detected dialog box (Figure 13-1) appears.

NOTE Do not connect two or more USB/GPIB interfaces.

Figure 13-1 USB/GPIB Interface Detected dialog box

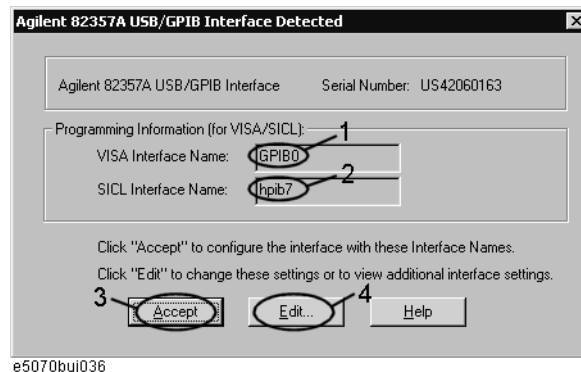

- Step 2.** Confirm that VISA Interface Name is set to GPIB0 (1 in Figure 13-1) and SICL Interface Name is set to hplib7 (2 in Figure 13-1) and then click the **Accept** button (3 in Figure 13-1). If the setting is correct, the procedure is complete. If the setting is different, click the **Edit** button (4 in Figure 13-1).
- Step 3.** The USB to GPIB Configuration dialog box (Figure 13-2) appears. Make the setting enclosed in the thick lines in Figure 13-2 (1 in Figure 13-2) according to the figure and then click the **OK** button (2 in Figure 13-2).

Figure 13-2 USB to GPIB Configuration dialog box

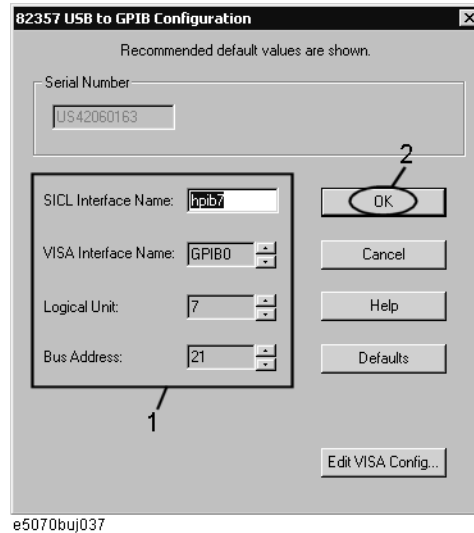

If you need to check/change the setting of the USB/GPIB interface after connecting the USB/GPIB interface, follow these steps:

- Step 1.** Press **System**.
- Step 2.** Press **Misc Setup**.
- Step 3.** Press **GPIB Setup**.
- Step 4.** Press **System Controller Configuration**.
- Step 5.** The IO Config dialog box (Figure 13-3) appears. Select (highlight) **GPIB0 hplib7** (1 in Figure 13-3) and then click the **Edit** button (2 in Figure 13-3).

NOTE

In the IO Config dialog box, do not click buttons other than specified here or do not change other settings because doing so may cause serious damage to the functions of the E5070B/E5071B.

Setting and Using the Control and Management Functions

Setting the GPIB

Figure 13-3

IO Config dialog box

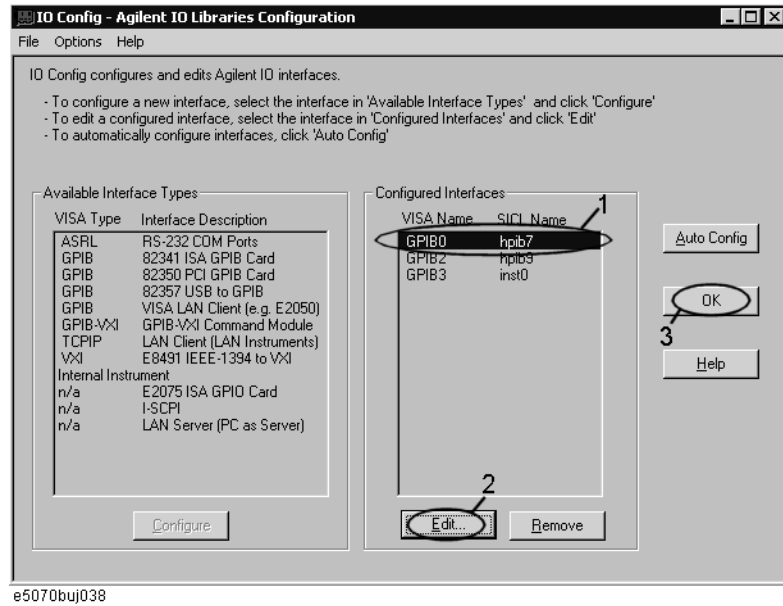

- Step 6.** The USB to GPIB Configuration dialog box (Figure 13-2) appears. Check/change the setting of the USB/GPIB interface and then click the **OK** button (2 in Figure 13-2).
- Step 7.** In the USB to GPIB Configuration dialog box, click the **OK** button (3 in Figure 13-3).

Setting the Internal Clock

The E5070B/E5071B has the built-in clock that keeps track of the date and time. This clock is used for the following functions.

- To display the current date and time in the instrument status bar at the lower part of the screen
- To write date and time information when saving internal data or a VBA program

Setting the Date and Time

- Step 1.** Press **System**.
- Step 2.** Press **Misc Setup**.
- Step 3.** Press **Clock Setup**.
- Step 4.** Press **Set Date and Time**.

The dialog box in Figure 13-4 appears.

Figure 13-4

Date/Time Properties Dialog Box (“Date & Time” Tab)

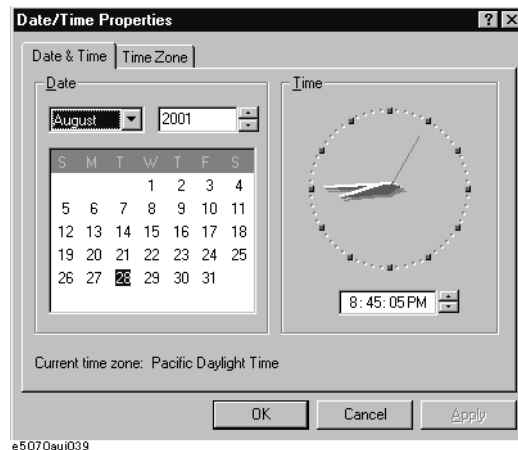

- Step 5.** Set the date in the **Date** area, and set the time in the **Time** area.
- Step 6.** Press the **Time Zone** tab.

The dialog box in Figure 13-5 appears.

Figure 13-5

Date/Time Properties Dialog Box (“Time Zone” Tab)



Step 7. In the drop-down list box select a time zone.

Step 8. To make the summertime setting automatically, check **Automatically adjust clock for daylight saving changes** to assign the check mark (√) to it.

Step 9. Press the **OK** button.

Setting the Date/Time Display ON/OFF

The date/time display in the instrument status bar can be switched on/off using the following procedure.

Step 1. Press **[System]**.

Step 2. Press **Misc Setup**.

Step 3. Press **Clock Setup**.

Step 4. Press **Show Clock** to switch the date/time display on/off.

Setting the Mouse

The user can change the setup for the mouse connected to the E5070B/E5071B and the movement of the pointer.

Setup Step

NOTE Be sure to use a mouse and a keyboard for mouse setup operations.

- Step 1. Press **System**.
- Step 2. Press **Misc Setup**.
- Step 3. Press **Control Panel** to open the Control Panel window.

Figure 13-6 Control Panel Window

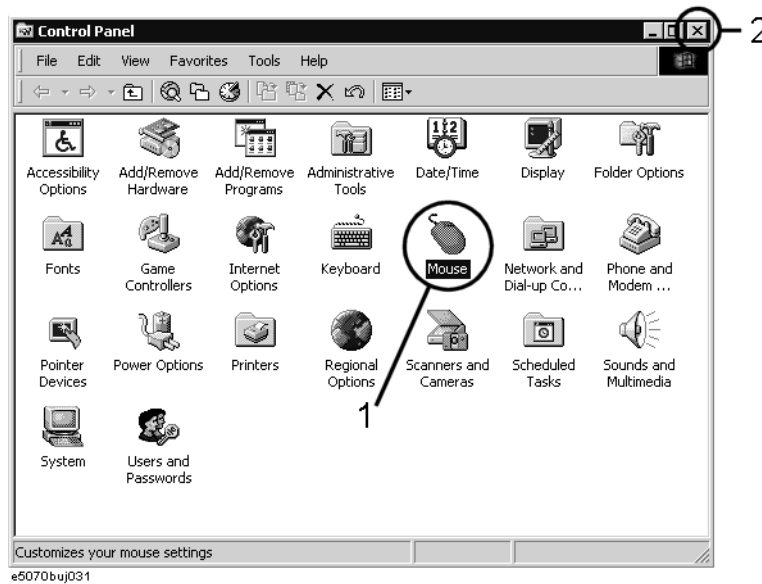

- Step 4. Double-click the **Mouse** icon (1 in Figure 13-6) in the Control Panel window.

NOTE Do not click icons other than specified here or do not change other settings because doing so may cause serious damage to the functions of the E5070B/E5071B.

Setting and Using the Control and Management Functions

Setting the Mouse

Step 5. The Mouse Properties dialog box (Figure 13-7) is displayed.

Define the setup for a right-handed/left-handed person in the **Buttons configuration** area. Define also the setup for double-click speed in the **Double-click speed** area.

Figure 13-7 Mouse Properties Dialog Box (Buttons tab)

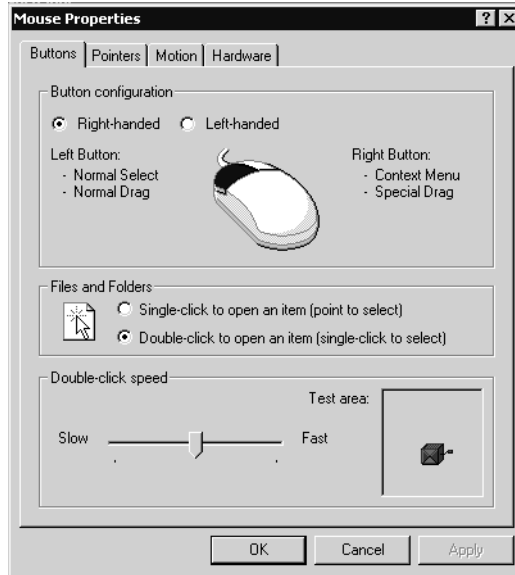

e5070buj028

Step 6. Click the **Pointers** tab (Figure 13-8).

Figure 13-8 Mouse Properties Dialog Box (Pointers tab)

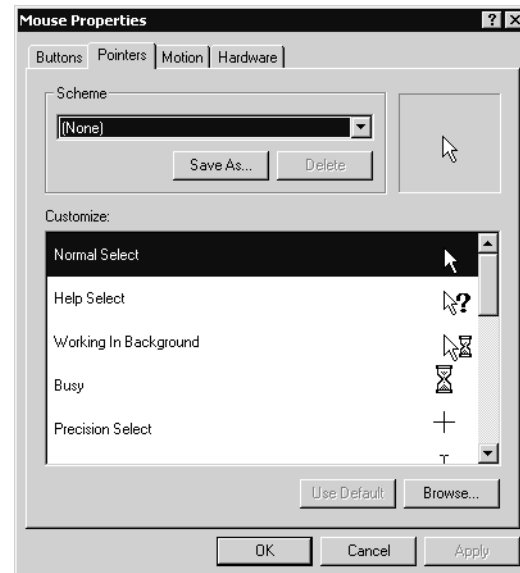

e5070buj029

Step 7. Enter a registration name into the **Scheme** box and specify the shapes of pointers for the registration name in the box below.

To create a registration name, click the **Save As...** button. Enter the registration name into the **Save Scheme** dialog box that appears, and click the **OK** button.

Step 8. Click the **Motion** tab (Figure 13-9).

Figure 13-9

Mouse Properties Dialog Box (Motion tab)

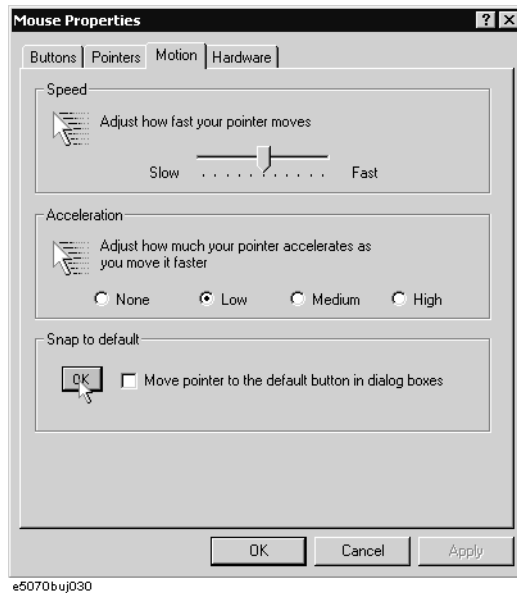

Step 9. Specify the pointer speed in the **Pointer speed** area and the pointer trail in the **Pointer trail** area.

Step 10. Click the **OK** button.

Step 11. Click the × button (2 in Figure 13-6) at the corner in the Control Panel window.

Configuring the Network

NOTE

When you use the E5070B/E5071B by connecting it to your LAN, consult your network administrator and make the setting of the LAN correctly.

This section describes how to set the following basic items necessary to connect the E5070B/E5071B to the LAN (Local Area Network).

- ❑ “Enabling/disabling network” on page 434
- ❑ “Setting IP address” on page 435
- ❑ “Specifying computer name” on page 437

If you need detail network settings, consult your network administrator and perform operation in the same way as the Windows 2000® PC.

Enabling/disabling network

You can enable/disable the network connection function of the E5070B/E5071B.

Follow these steps to enable/disable the network connection function.

- Step 1.** Use the LAN cable to connect the E5070B/E5071B to the LAN.
- Step 2.** Press **[System]**.
- Step 3.** Press **Misc Setup**.
- Step 4.** Press **Network Setup**.
- Step 5.** Press **Network Configuration** to open the Network and Dial-up Connections window (Figure 13-10).

Figure 13-10

Network and Dial-up Connections window

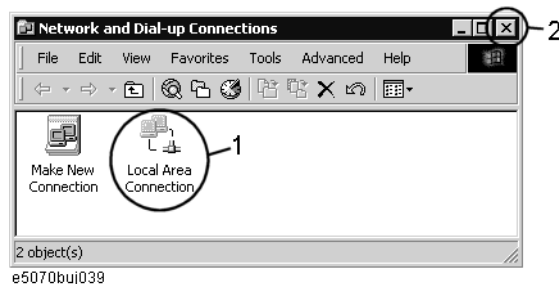

Step 6. When switching from disable to enable:

Double-click the Local Area Connection icon (1 in Figure 13-10) in the Network and Dial-up connections window to enable the network connection function.

When switching from enable to disable:

Double-click the Local Area Connection icon (1 in Figure 13-10) in the Network and Dial-up Connections window. The Local Area Connection Status dialog box (Figure 13-11) appears. Click the **Disable** button (1 in Figure 13-11) to disable the network connection function.

Figure 13-11 Local Area Connection Status dialog box

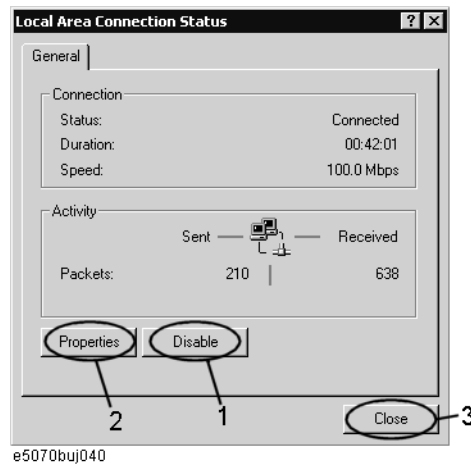

Step 7. Click the × button (2 in Figure 13-10) in the upper right of the Network and Dial-up Connections window.

Setting IP address

Follow these steps to set the IP address:

- Step 1.** Press **[System]**.
- Step 2.** Press **Misc Setup**.
- Step 3.** Press **Network Setup**.
- Step 4.** Press **Network Configuration**.
- Step 5.** Double-click the Local Area Connection icon (1 in Figure 13-10) in the Network and Dial-up Connections window. The Local Area Connection Status dialog box (Figure 13-11) appears. Click the **Properties** button (2 in Figure 13-11).

Setting and Using the Control and Management Functions Configuring the Network

Step 6. The Local Area Connection Properties dialog box (Figure 13-12) appears. Select (highlight) **Internet Protocol (TCP/IP)** (1 in Figure 13-12) and then click the **Properties** button (2 in Figure 13-12).

Figure 13-12

Local Area Connection Properties dialog box

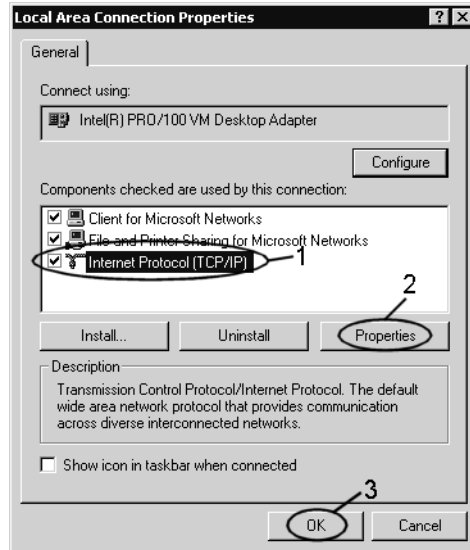

Step 7. The Internet Protocol (TCP/IP) Properties dialog box (Figure 13-13) appears. Click (select) **Use the following IP address** (1 in Figure 13-13) and then enter the IP address (2 in Figure 13-13), the subnet mask (3 in Figure 13-13), and the gateway address (4 in Figure 13-13).

If the IP address can be obtained automatically (if the DHCP server can be used), click (select) **Obtain an IP address automatically** (5 in Figure 13-13).

Figure 13-13

Internet Protocol (TCP/IP) Properties dialog box

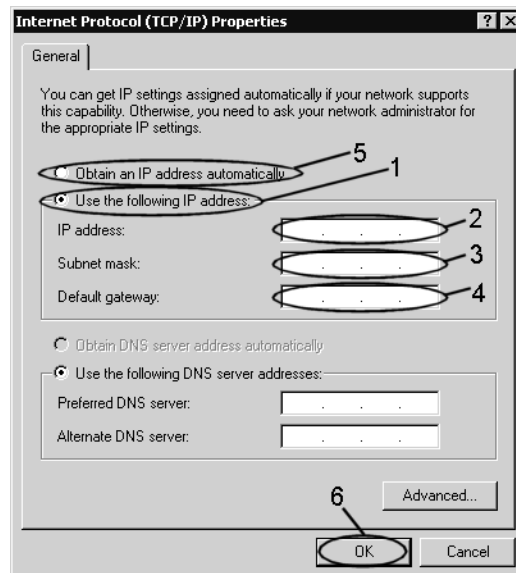

- Step 8.** In the Internet Protocol (TCP/IP) Properties dialog box, click the **OK** button (6 in Figure 13-13).
- Step 9.** In the Local Area Connection Properties dialog box, click the **OK** button (3 in Figure 13-12).
- Step 10.** In the Local Area Connection Status dialog box, click the **Close** button (3 in Figure 13-11).
- Step 11.** Click the × button (2 in Figure 13-10) in the upper right of the Network and Dial-up Connections window.

Specifying computer name

Follow these steps to specify the computer name:

- Step 1.** Press **System**.
- Step 2.** Press **Misc Setup**.
- Step 3.** Press **Network Setup**.
- Step 4.** Press **Network Identification**.
- Step 5.** The System Properties dialog box (Figure 13-14) appears. Click the **Properties** button (1 in Figure 13-14).

Figure 13-14

System Properties dialog box

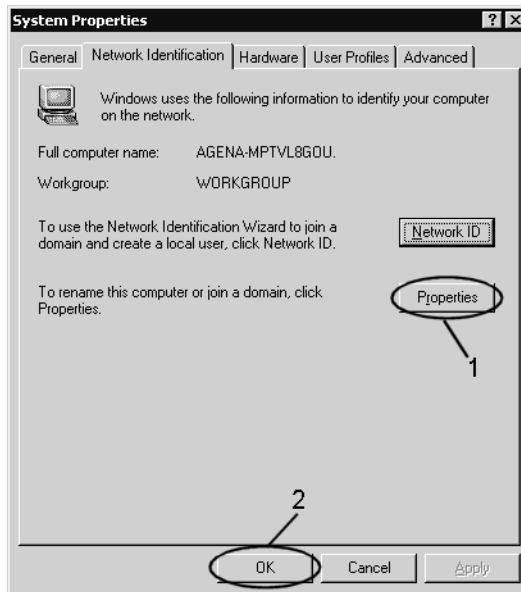

e5070buj043

Setting and Using the Control and Management Functions Configuring the Network

Step 6. The Identification Changes dialog box (Figure 13-15) appears. Enter the computer name in the **Computer Name** box (1 in Figure 13-15).

Figure 13-15

Identification Changes dialog box

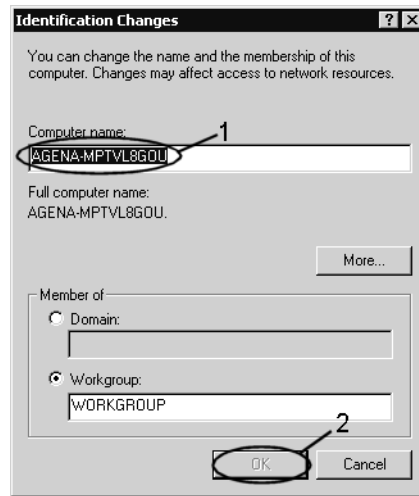

e5070buj044

Step 7. The Network Identification dialog box (Figure 13-16) appears. Click the **OK** button.

Figure 13-16

Network Identification dialog box



e5070buj045

Step 8. In the Identification Changes dialog box, click the **OK** button (2 in Figure 13-15).

Step 9. In the System Properties dialog box, click the **OK** button (2 in Figure 13-14).

Step 10. The System Settings Change dialog box (Figure 13-17) appears. Click the **Yes** button to restart the E5070B/E5071B.

Figure 13-17

System Settings Change dialog box

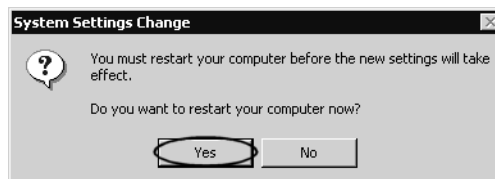

e5070buj046

NOTE

Until the E5070B/E5071B is restarted, changed setting does not take effect.

Remote Control Using HTTP

You can access the web page installed in the E5070B/E5071B by using the hypertext transfer protocol (http) and the E5070B/E5071B's IP address from the external PC's web browser. Through the built-in web page, you can control the E5070B/E5071B remotely and display the measurement screen on external PCs.

The following browsers are recommended:

- Java Script enabled browser
- Internet Explorer 5
- Netscape 4.7

The following information will help you to remotely control the E5070B/E5071B via the built-in web page.

Required Modification of Settings

Network

Configure the E5070B/E5071B's network correctly. For detailed information on configuration and notes, see "Configuring the Network" on page 434.

Enabling Web Server

Enable the web server for the E5070B/E5071B so that it may allow access from an external PC. Follow these steps:

- Step 1.** Press **System**.
- Step 2.** Press **Misc Setup - Network Setup**.
- Step 3.** Press **Web Server** to turn it on. The default is OFF.

NOTE This function is available only when the Internet Information Services (IIS) is installed in the E5070B/E5071B. The web server softkey is not displayed if the IIS is not installed.

NOTE The external PC must have the Java™ Runtime Environment installed.

How to Start VNC Server Configuration

To restrict external access, set a password for the VNC server configuration.

The following is a description of how to start the VNC server configuration. Visit the web site at <http://www.realvnc.com> for information on the password setting procedure and VNC server.

- Step 1.** Press **System**.
- Step 2.** Press **Misc Setup - Network Setup**.
- Step 3.** Press **VNC Server Configuration** to start the VNC Server Properties.

Accessing Hard Disk of E5070B/E5071B from External PC

If you connect the E5070B/E5071B to LAN, you can access the hard disk (D drive) in the E5070B/E5071B as a network drive from an external PC connected to the same LAN.

NOTE

See “Connecting Hard Disk (Shared Folder) of External PC” of Chapter 6, “Application Programs” in *VBA Programmer’s Guide* for information on accessing the hard disk of the external PC connected to the same LAN from the E5070B/E5071B.

Figure 13-18

Accessing to drive D of E5070B/E5071B from external PC

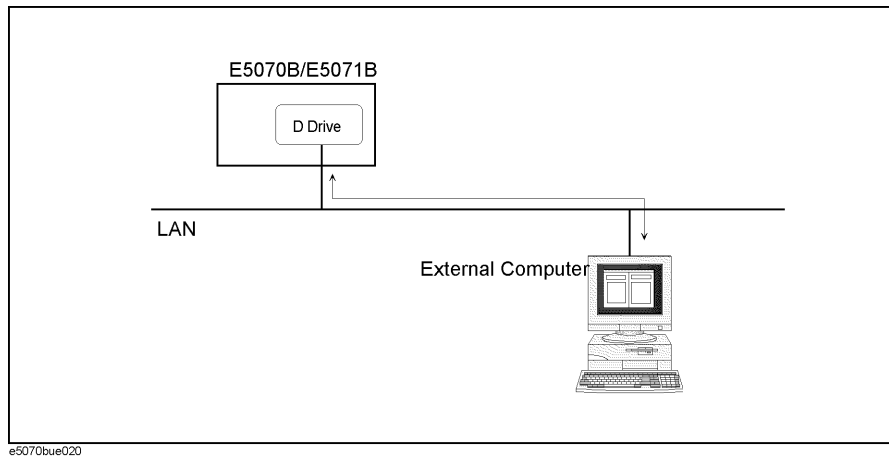

Enabling the access form the external PC

This section shows the simplest procedure to enable the access from the external PC.

NOTE

It is recommended that you use setting with higher security consulting your network administrator.

- Step 1.** Press .
- Step 2.** Press **Explorer...**
- Step 3.** The Windows Explorer (refer to Figure 10-8 on page 367) opens. Select (highlight) **USER (D:)** and then click **Properties** in the File menu.

Step 4. The USERS(D:) Properties dialog box (Figure 13-19) appears. Select the **Sharing** tab.

Figure 13-19 USERS(D:) Properties dialog box (General tab)

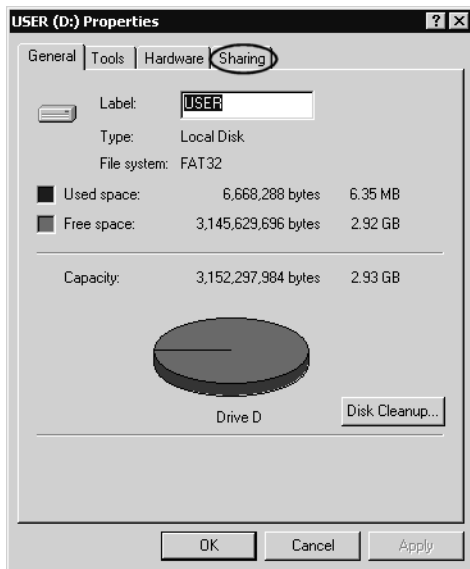

e5070buj047

Step 5. Click the **New Share** button (1 in Figure 13-20).

Figure 13-20 USERS(D:) Properties dialog box (Sharing tab)

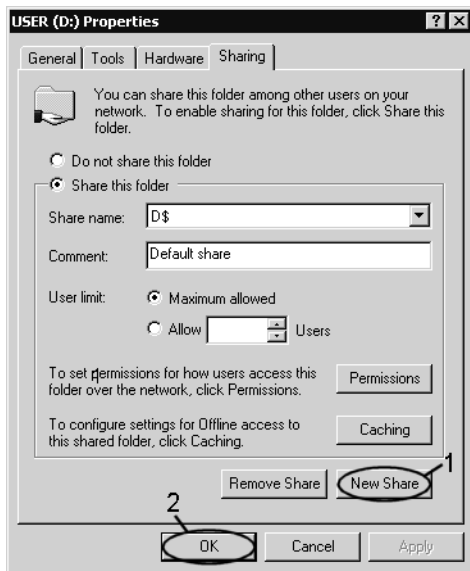

e5070buj048

13. Setting and Using the Control and Management Functions

Setting and Using the Control and Management Functions

Accessing Hard Disk of E5070B/E5071B from External PC

- Step 6.** The New Share dialog box (Figure 13-21) appears. Enter the share name (name used when accessed from the external PC) in the **Share Name** box (1 in Figure 13-21) and click the **OK** button (2 in Figure 13-21).

Figure 13-21

New Share dialog box

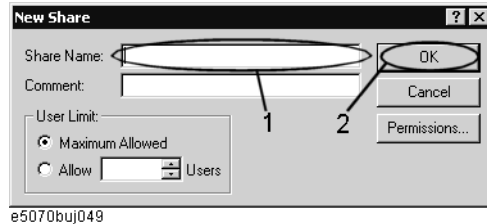

- Step 7.** In the USERS(D:) Properties dialog box, click the **OK** button (2 in Figure 13-20).

Accessing hard disk of E5070B/E5071B from external PC

This section describes the procedure to connect to the hard disk (D drive) in the E5070B/E5071B to which access has been made possible according to the procedure described in “Enabling the access form the external PC” on page 440 from the external PC, taking Windows NT ® as an example.

NOTE

For information on connection, see your PC's operation manual.

- Step 1.** From the Start menu, click Programs - Windows Explorer to start the Explorer.
- Step 2.** From the Explorer's menu, click **Tools - Map Network Drive...**
- Step 3.** The Map Network Drive dialog box appears. Select an appropriate drive, enter **\\C_NAME\S_NAME** as the network path and then click the **OK** button.
- C_NAME** in the network path is the computer name of the E5070B/E5071B and **S_NAME** is the share name of the D drive. For information on how to set the computer name, refer to “Specifying computer name” on page 437; for information on how to set the share name, refer to “Enabling the access form the external PC” on page 440.
- Step 4.** The dialog box to enter the user name and the password appears. Enter an appropriate user name and password and then click the **OK** button.

The user name and password differ depending on the setting made when enabling access from the external PC. When you have set them according to “Enabling the access form the external PC” on page 440, you can make connection using the user name, **agena**, without the password.

Disabling USB Mass Storage Device

You can disable any USB-compatible external mass storage devices in order to ensure confidentiality or for other reasons.

Steps for Setting Modification

The following procedure shows how to disable a USB Mass Storage Device.

- Step 1.** Press .
- Step 2.** Press **Explorer...**
- Step 3.** Double-click DisableUsbStorage.exe from D:\Agilent\Service.
- Step 4.** Click OK in the SUCCEEDED message window that appears. If any USB mass storage device is connected to the E5070B/E5071B under this condition, the Hardware Wizard will start, but the USB mass storage device will not work.

The procedure shows how to enable a USB Mass Storage Device.

- Step 1.** Press .
- Step 2.** Press **Explorer...**
- Step 3.** Double-click EnableUsbStorage.exe from D:\Agilent\Service.
- Step 4.** Click OK in the SUCCEEDED message window that appears.

NOTE

If you do not want any USB mass storage device to ever be enabled at any time, delete EnableUsbStorage.exe from the E5070B/E5071B after DisableUsbStorage.exe has been completed.

These two programs will not be recovered automatically by applying the firmware update or other such action. Before deleting any of these programs, you should make a backup copy to a recording medium such as a floppy disk and store it separately.

NOTE

If the program fails to run, it is possible that you have not logged in as a user in the Administrators Group. When you want to execute any of the above programs, make sure to log in as a user in the Administrators Group.

Locking the Front Keys, Keyboard, and/or Mouse (Touch Screen)

You can lock (disable) the front keys, keyboard, and/or mouse (touch screen). This feature prevents erroneous operation caused by inadvertently touching any of these devices.

Locking the Front Keys, Keyboard, and/or Mouse

- Step 1.** Press **System**.
- Step 2.** Press **Misc Setup**.
- Step 3.** Press **Key Lock**.
- Step 4.** Press the corresponding key to switch the lock on/off.

Table 13-1

Softkey	Function
Front Panel & Keyboard Lock	Switches the lock for the front panel keys and keyboard on/off.
Touch Screen & Mouse Lock	Switches the lock for the touch screen and mouse on/off.

NOTE

You cannot use a locked device to unlock that same device. To unlock the front panel keys, keyboard, touch screen and mouse that have been locked, press the Standby switch to turn off the power supply and then turn it on again. When setting at power-on, the front panel keys, keyboard, touch screen and mouse are all in an unlocked condition.

Setting the Beeper (Built-in Speaker)

The E5070B/E5071B has a built-in speaker that sounds a beep tone. The beeper allows you to make two types of settings shown in Table 13-2.

Table 13-2

Type	Function
Operation complete beeper	<p>Sounds a beep tone to inform the user that operations have completed.</p> <ul style="list-style-type: none"> • When calibration data measurements are done • When data storage has completed
Warning beeper	<p>Sounds a beep tone to prompt the user to use caution.</p> <ul style="list-style-type: none"> • When an instrument error occurs (An error message appears at the same time.) • When a limit test fails

The warning beeper sounds slightly longer than the operation complete beeper.

Setting the Operation Complete Beeper

- Step 1.** Press **System**.
- Step 2.** Press **Misc Setup**.
- Step 3.** Press **Beeper**.
- Step 4.** Press **Beep Complete** to switch the operation complete beeper on/off.

Pressing **Test Beep Complete** allows you to hear and check the beep tone of the operation complete beeper.

Setting the Warning Beeper

- Step 1.** Press **System**.
- Step 2.** Press **Misc Setup**.
- Step 3.** Press **Beeper**.
- Step 4.** Press **Beep Warning** to switch the warning beeper on/off.

Pressing **Test Beep Warning** allows you to hear and check the beep tone of the warning beeper.

Turning off the LCD Screen Backlight

You can switch off the backlight (illumination) of the LCD screen of the E5070B/E5071B. This extends the life of the backlight when using it continuously over a long period.

Turning off the LCD Screen Backlight

Step 1. Press **System**.

Step 2. Press **Backlight** to switch the backlight on/off.

Switching off the backlight causes indications on the LCD screen to be almost invisible.

The backlight that has been switched off can be turned on again by pressing **Preset**. When the LCD backlight is off, **Preset** works as a key for switching the backlight back on.

Checking the product information

Checking the serial number

The serial number of the E5070B/E5071B can be checked using the following procedure.

Procedure to check the serial number

- Step 1.** Press **System**.
- Step 2.** Press **Service Functions**.
- Step 3.** Press **Enable Options**.

The serial number is displayed in the softkey menu bar.

NOTE

The serial number can be also checked by following the procedure of “Checking other product information.”

Checking other product information

The product information installed in the E5070B/E5071B can be checked using the following procedure.

The product information that can be checked are as follows.

- Firmware Revision
- Option
- Date when firmware was construct
- Serial Number
- IP Address
- MAC Address
- USB ID

Procedure

- Step 1.** Press **System**.
- Step 2.** Press **Firmware Revision**.
The Firmware Revision dialog box (Figure 13-22) appears.

Figure 13-22

Firmware Revision dialog box

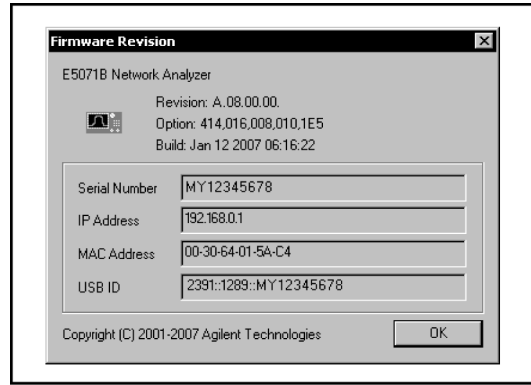

e5070buj10004

Step 3. Press **OK** to close the dialog box.

Setting the preset function

Showing/hiding the confirmation buttons when presetting

The preset function can be executed without displaying the **OK** and **Cancel** softkey buttons when pressing the preset button of the E5070B/E5071B.

Operational procedure

- Step 1.** Press **System**.
- Step 2.** Press **Misc Setup**.
- Step 3.** Press **Preset Setup**.
- Step 4.** **Confirm** to toggle on (show)/off (hide) the confirmation buttons.

Setting the user preset function

You can save the instrument state of the E5070B/E5071B into a file in the mass storage, and then recall it with the preset function to reproduce that state.

If no user preset instrument state is stored, you cannot set the user preset function. For more information on saving instrument states, see “Saving a user-preset instrument state” on page 450.

Operational procedure

- Step 1.** Press **System**.
- Step 2.** Press **Misc Setup**.
- Step 3.** Press **Preset Setup**.
- Step 4.** Press **State**.
- Step 5.** Use one of the following keys for the desired setting.

Table 13-3

Softkey	Function
Factory	Specifies the normal preset function.
User	Specifies the user-preset function.
Cancel	Returns to the softkey display in one upper level.

Saving a user-preset instrument state

To execute the user-preset function, you must have a preset setting file that has been saved. Follow these steps to save a preset instrument state of the E5070B/E5071B.

Operational procedure

- Step 1.** Sets up a preset instrument state you want to save.
- Step 2.** Press .
- Step 3.** Press **Save State**.
- Step 4.** Pressing **User Pres** saves the instrument state.

System Recovery

By executing system recovery, you can return the system of the E5070B/E5071B (the Windows operating system and the firmware) to the factory state (at the time of purchase ^{*1}).

The system recovery procedures vary depending on the mother board the E5070B/E5071B is equipped with. The recovery procedures are indicated for each serial number of the factory-equipped mother board type; they may not conform to the actual board, if it was replaced for servicing. In this case, follow the step (2) below to perform a system recovery.

Types of system recoveries

The following two types of system recoveries are available.

Factory recovery

Returns the contents of the C drive to the factory state.

User recovery^{*2}

Returns the contents of the C drive to a user-specified state. To use this function, you must prepare for recovery in advance. For information on preparation, see “Procedure to create the user backup image (1)” on page 455 or “Procedure to create the user backup image (2)” on page 464 for information on the execution. Also, see “Procedure to execute the user recovery function (1)” on page 458 or “Procedure to execute the user recovery function (2)” on page 467.

Notes on executing system recovery

Executing system recovery causes the following:

- In addition to the Windows operating system and the firmware, the following settings of the E5070B/E5071B are returned to the factory state.
 - Network setting
 - GPIB setting
 - Printer setting
- The driver for the supported printer installed after purchase is deleted.
- You need to execute initial registration again.

Files you created using the save function (files in the D drive) are not affected, but we recommend backing them up before executing system recovery for precautionary purposes. For more information on backup, refer to “Making Backup Files” on page 576.

^{*1}. If the hard disk failed and has been replaced after purchase, the state when the replacement was performed is recovered.

^{*2}. This function is available when the volume label on the hard disk is CP600 or higher.

Procedure to execute the factory function (1)

This procedure is valid for the E5070B : JP1KKxxxxx, MY42300632 and below, E5071B : JP1KKxxxxx, MY42301396 and below. If your unit doesn't follow the procedure written below, please refer to "Procedure to execute the factory recovery function (2)" on page 461 for the detail.

This section describes how to return the contents of the C drive to the factory state.

NOTE

You need the keyboard for this operation.

- Step 1.** Shut down the E5070B/E5071B.
- Step 2.** Connect the keyboard to the E5070B/E5071B.
- Step 3.** Insert the disk for the system recovery into the floppy disk drive of the E5070B/E5071B.
- Step 4.** Press the standby switch of the E5070B/E5071B to turn it on.
- Step 5.** When the screen as shown in the figure below appears, press and hold **F12** of the keyboard until this screen disappears.

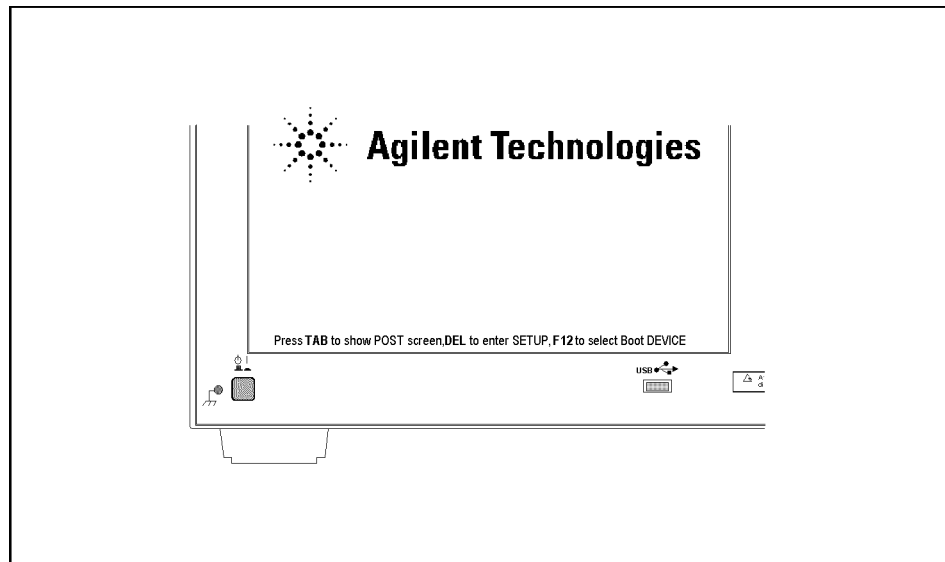

e5070buj034

NOTE

After several seconds, the next screen appears automatically even if you do not press any key, so do not miss it.

If the above message does not appear, the instrument is at fault; contact your local Agilent customer center listed at the end of this manual or distributor.

Step 6. The following screen appears. Check that Floppy is selected (highlighted) (if Floppy is not selected, select it with **↑** of the keyboard), and press **Enter** of the keyboard.

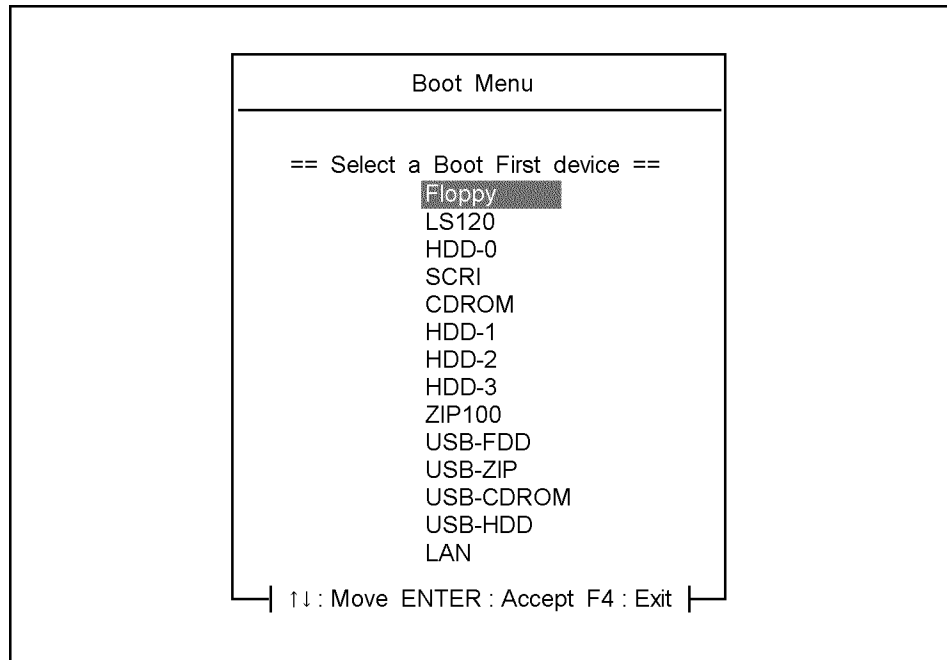

Step 7. The message as shown below appears. Press **1** of the keyboard. If you want to cancel the factory recovery, press **4** here.

```

Agilent Technologies System Utilities
Recovery & Backup Options for the E5070/71B

```

Choose One of the following:

-
1. Recover Factory Backup Image
 2. Create User Backup Image
 3. Recover User Backup Image
 4. Exit
-

Enter a Choice: _

NOTE

If the above message does not appear, the instrument or the disk for the system recovery is at fault; contact your local Agilent customer center listed at the end of this manual or distributor.

Setting and Using the Control and Management Functions

System Recovery

- Step 8.** The message as shown below appears. Press **C** of the keyboard. If you want to cancel the factory recovery, press **E** here.

You chose to Restore your system by installing the original factory installed OS and system software.

WARNING: Press C to Continue only if you are sure that you want to proceed. The C: Drive will be completely overwritten with no chance of recovering any data. Use Option 1 to recover the system from a serious malfunction caused by corrupted or inadvertently deleted files on the system's primary C: partition.

Press C to Continue or E to Exit: _

- Step 9.** The message as shown below appears. Press **C** of the keyboard to start the factory recovery. If you want to cancel the factory recovery, press **E** here.

CAUTION! Interrupting this process may leave the system in an unstable state. Allow the software to complete the backup and recovery process. This may take up to 20 minutes depending on the system configuration.

Press C to Continue or E to Exit: _

CAUTION

Never turn off the power during the system recovery because doing so may cause serious damage to the E5070B/E5071B.

- Step 10.** The factory recovery will be complete in about 5 minutes. When the factory recovery is complete, the message as shown below appears. Press **Ctrl**, **Alt**, and **Delete** of the keyboard at the same time to restart.

Remove the disk and Press CLT+ALT+DEL to restart your system.

NOTE

If the above message does not appear, the instrument is at fault; contact your local Agilent customer center listed at the end of this manual or distributor.

- Step 11.** After restart, the screen for initial registration appears. Execute initial registration. For information on the execution procedure, refer to *Installation/Quick Start Guide*.
- Step 12.** For the E5070B/E5071B equipped with the Option 016 touch screen, execute the calibration of the touch screen. For information on the execution procedure, refer to “Calibration of the Touch Screen” on page 470.

Procedure to create the user backup image (1)

This procedure is valid for the E5070B : JP1KKxxxxx, MY42300632 and below, E5071B : JP1KKxxxxx, MY42301396 and below. If your unit doesn't follow the procedure written below, please refer to "Procedure to create the user backup image (2)" on page 464 for the detail.

This section describes how to create the user backup image. The C drive contents saved in this creation are recalled when the user recovery function is executed.

NOTE This function is available when the volume label on the hard disk is CP600 or higher.

NOTE You need the keyboard for this operation.

- Step 1.** Shut down the E5070B/E5071B.
- Step 2.** Connect the keyboard to the E5070B/E5071B.
- Step 3.** Insert the disk for the system recovery into the floppy disk drive of the E5070B/E5071B.
- Step 4.** Press the standby switch of the E5070B/E5071B to turn it on.
- Step 5.** When the screen as shown in the figure below appears, press and hold **F12** of the keyboard until this screen disappears.

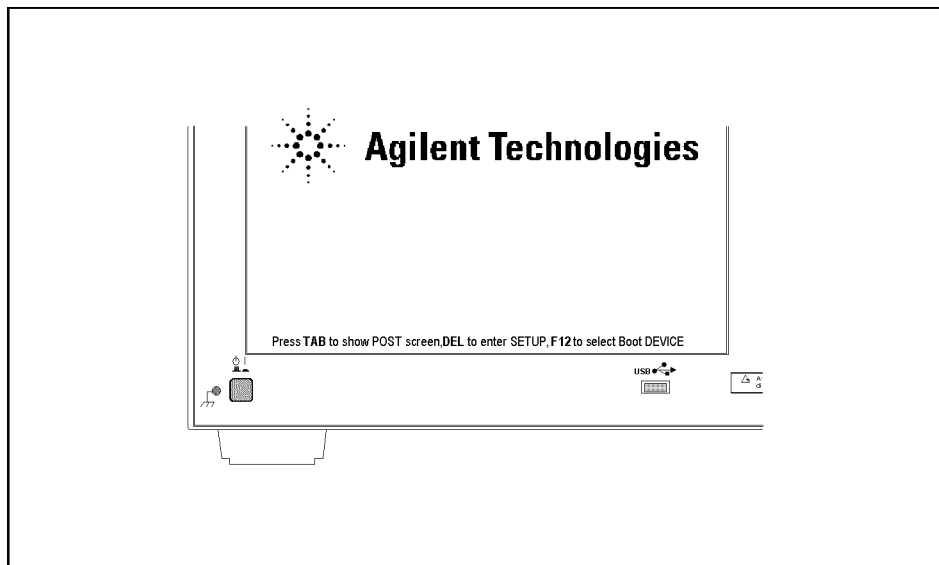

e5070bu034

NOTE After several seconds, the next screen appears automatically even if you do not press any key, so do not miss it.

If the above message does not appear, the instrument is at fault; contact your local Agilent customer center listed at the end of this manual or distributor.

Setting and Using the Control and Management Functions

System Recovery

Step 6. The following screen appears. Check that Floppy is selected (highlighted) (if Floppy is not selected, select it with of the keyboard), and press of the keyboard.

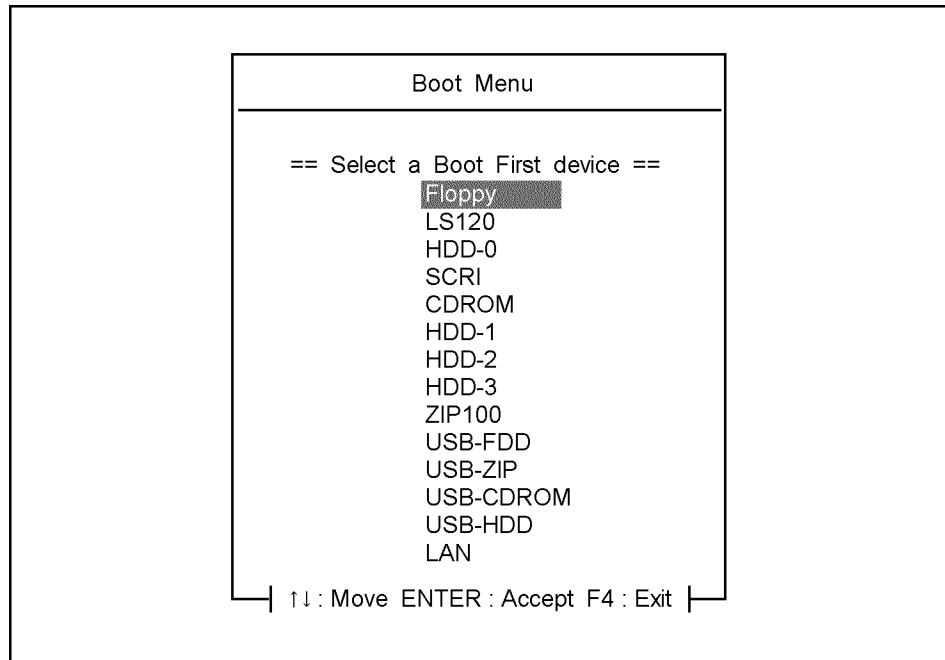

Step 7. The message as shown below appears. Press of the keyboard. If you want to cancel the create user backup image, press here.

```
Agilent Technologies System Utilities
Recovery & Backup Options for the E5070/71B
```

Choose One of the following:

-
1. Recover Factory Backup Image
 2. Create User Backup Image
 3. Recover User Backup Image
 4. Exit
-

Enter a Choice: _

NOTE

If the above message does not appear, the instrument or the disk for the system recovery is at fault; contact your local Agilent customer center listed at the end of this manual or distributor.

- Step 8.** The message as shown below appears. Press **C** of the keyboard. If you want to cancel the create user backup image, press **E** here.

You chose to create a backup image file of your system.

The system will perform a quick integrity check of the file structure on the C: Drive. It will then copy the C: partition to an image file and store it on the System Recovery partition.

Press C to Continue or E to Exit: _

- Step 9.** The message as shown below appears. Press **C** of the keyboard to start the create user backup image. If you want to cancel the create user backup image, press **E** here.

CAUTION! Interrupting this process may leave the system in an unstable state. Allow the software to complete the backup and recovery process. This may take up to 20 minutes depending on the system configuration.

Press C to Continue or E to Exit: _

CAUTION

Never turn off the power during the create user backup image because doing so may cause serious damage to the E5070B/E5071B.

- Step 10.** The create user backup image will be complete in about 5 minutes. When the create user backup image is complete, the message as shown below appears. Press **Ctrl**, **Alt**, and **Delete** of the keyboard at the same time to restart.

Remove the disk and Press CLT+ALT+DEL to restart your system.

NOTE

If the above message does not appear, the instrument is at fault; contact your local Agilent customer center listed at the end of this manual or distributor.

Setting and Using the Control and Management Functions System Recovery

Procedure to execute the user recovery function (1)

This procedure is valid for the E5070B : JP1KKxxxxx, MY42300632 and below, E5071B : JP1KKxxxxx, MY42301396 and below. If your unit doesn't follow the procedure written below, please refer to "Procedure to execute the user recovery function (2)" on page 467 for the detail.

Returns the contents of the C drive to a user-specified state. To use this function, you must create the user backup image in advance. For more information, see the description "Procedure to create the user backup image (1)" on page 455.

NOTE This function is available when the volume label on the hard disk is CP600 or higher.

NOTE You need the keyboard for this operation.

- Step 1.** Shut down the E5070B/E5071B.
- Step 2.** Connect the keyboard to the E5070B/E5071B.
- Step 3.** Insert the disk for the system recovery into the floppy disk drive of the E5070B/E5071B.
- Step 4.** Press the standby switch of the E5070B/E5071B to turn it on.
- Step 5.** When the screen as shown in the figure below appears, press and hold **F12** of the keyboard until this screen disappears.

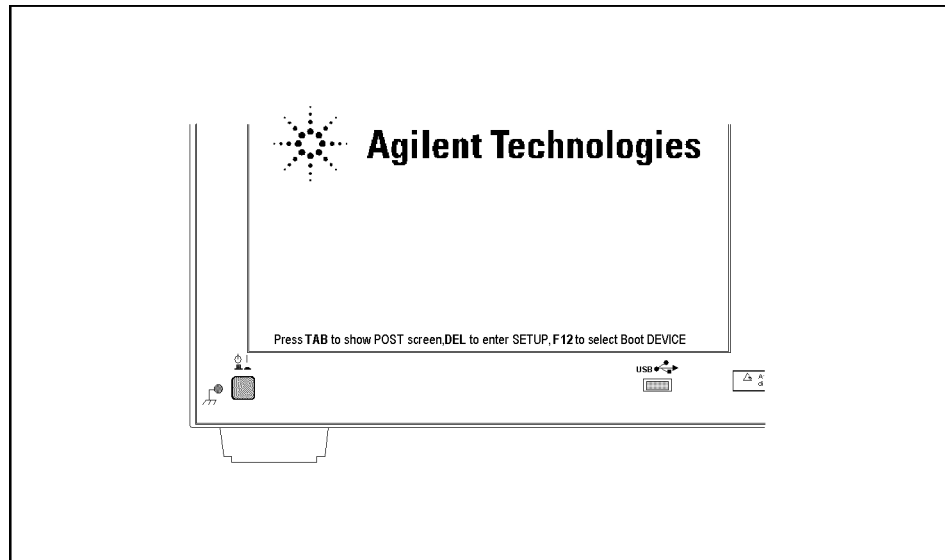

e5070buj034

NOTE After several seconds, the next screen appears automatically even if you do not press any key, so do not miss it.

If the above message does not appear, the instrument is at fault; contact your local Agilent customer center listed at the end of this manual or distributor.

Step 6. The following screen appears. Check that Floppy is selected (highlighted) (if Floppy is not selected, select it with **↑** of the keyboard), and press **Enter** of the keyboard.

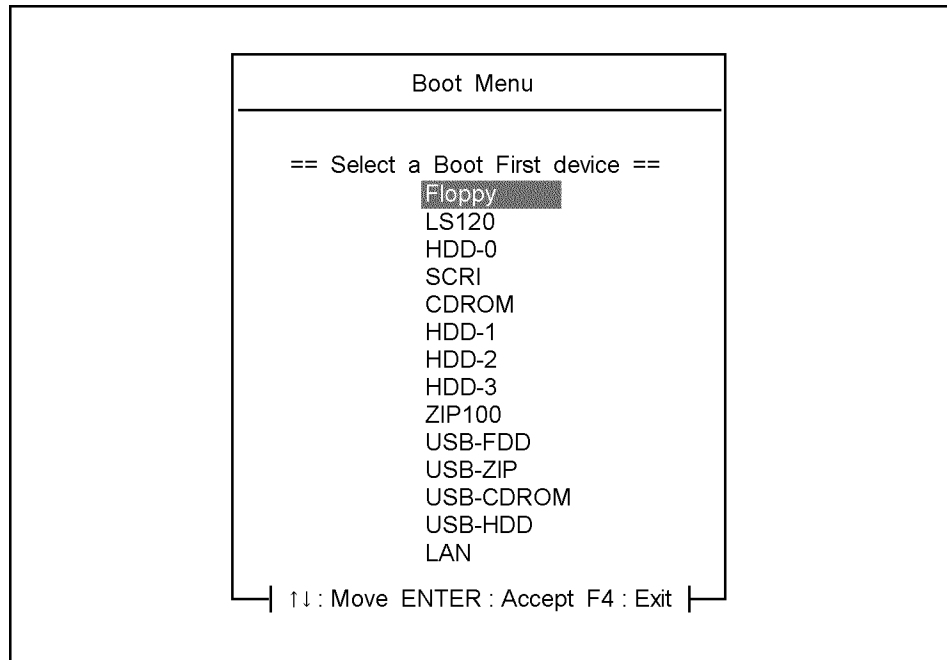

Step 7. The message as shown below appears. Press **3** of the keyboard. If you want to cancel the user recovery, press **4** here.

```

Agilent Technologies System Utilities
Recovery & Backup Options for the E5070/71B

```

Choose One of the following:

-
1. Recover Factory Backup Image
 2. Create User Backup Image
 3. Recover User Backup Image
 4. Exit
-

Enter a Choice: _

NOTE

If the above message does not appear, the instrument or the disk for the system recovery is at fault; contact your local Agilent customer center listed at the end of this manual or distributor.

Setting and Using the Control and Management Functions

System Recovery

- Step 8.** The message as shown below appears. Press **C** of the keyboard. If you want to cancel the user recovery, press **E** here.

You chose to recover your own system backup image file.

WARNING: Press C to Continue only if you are sure that you want to proceed. The C: partition will be completely overwritten with no chance of recovering any data. Use Option 3 to recover the system from a serious malfunction caused by corrupted or inadvertently deleted files on the system's primary C: partition.

Press C to Continue or E to Exit: _

- Step 9.** The message as shown below appears. Press **C** of the keyboard to start the user recovery. If you want to cancel the user recovery, press **E** here.

CAUTION! Interrupting this process may leave the system in an unstable state. Allow the software to complete the backup and recovery process. This may take up to 20 minutes depending on the system configuration.

Press C to Continue or E to Exit: _

CAUTION

Never turn off the power during the system recovery because doing so may cause serious damage to the E5070B/E5071B.

- Step 10.** The user recovery will be complete in about 5 minutes. When the user recovery is complete, the message as shown below appears. Press **Ctrl**, **Alt**, and **Delete** of the keyboard at the same time to restart.

Remove the disk and Press CLT+ALT+DEL to restart your system.

NOTE

If the above message does not appear, the instrument is at fault; contact your local Agilent customer center listed at the end of this manual or distributor.

Procedure to execute the factory recovery function (2)

This procedure is valid for the E5070B : MY42300633, and above, E5071B : Y42301397 and above. If your unit doesn't follow the procedure written below, please refer to "Procedure to execute the factory function (1)" on page 452 for the detail.

This section describes how to return the contents of the C drive to the factory state.

NOTE You need the keyboard for this operation.

- Step 1.** Shut down the E5070B/E5071B.
- Step 2.** Connect the keyboard to the E5070B/E5071B.
- Step 3.** Insert the disk for the system recovery into the floppy disk drive of the E5070B/E5071B.
- Step 4.** Press the standby switch of the E5070B/E5071B to turn it on.
- Step 5.** When the screen as shown in the figure below appears, press and hold  of the keyboard until this screen disappears.

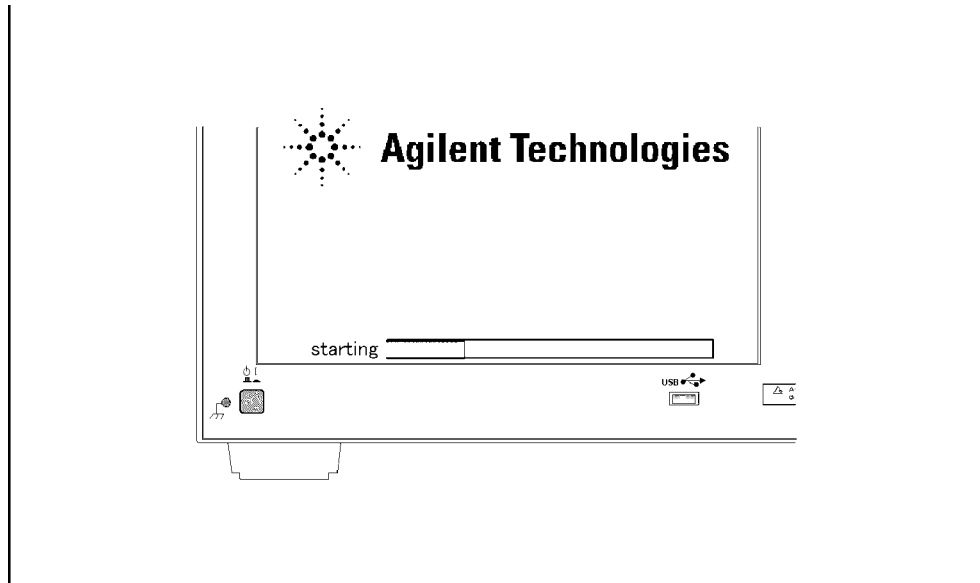

e5061buj034

NOTE After several seconds, the next screen appears automatically even if you do not press any key, so do not miss it.

If the above message does not appear, the instrument is at fault; contact your local Agilent customer center listed at the end of this manual or distributor.

Setting and Using the Control and Management Functions

System Recovery

Step 6. The following screen appears. Select “+Removable Devices” with of the keyboard, and press of the keyboard.

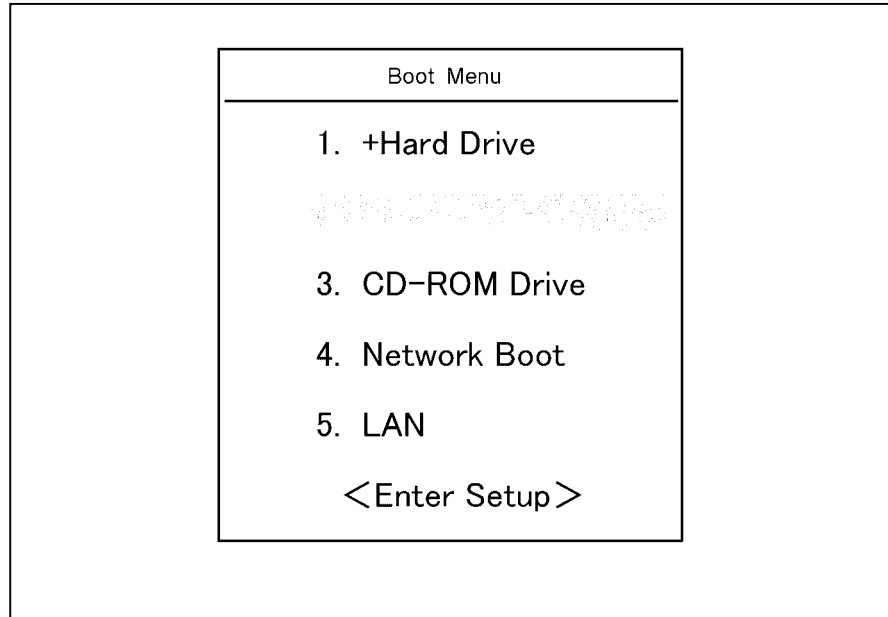

Step 7. The message as shown below appears. Press of the keyboard. If you want to cancel the user recovery, press here.

```

Agilent Technologies System Utilities
Recovery & Backup Options for the E5070/71B

```

Choose One of the following:

-
1. Recover Factory Backup Image
 2. Create User Backup Image
 3. Recover User Backup Image
 4. Exit
-

Enter a Choice: _

NOTE

If the above message does not appear, the instrument or the disk for the system recovery is at fault; contact your local Agilent customer center listed at the end of this manual or distributor.

- Step 8.** The message as shown below appears. Press **C** of the keyboard. If you want to cancel the factory recovery, press **E** here.

You chose to Restore your system by installing the original factory installed OS and system software.

WARNING: Press C to Continue only if you are sure that you want to proceed. The C: Drive will be completely overwritten with no chance of recovering any data. Use Option 1 to recover the system from a serious malfunction caused by corrupted or inadvertently deleted files on the system's primary C: partition.

Press C to Continue or E to Exit: _

- Step 9.** The message as shown below appears. Press **C** of the keyboard to start the factory recovery. If you want to cancel the factory recovery, press **E** here.

CAUTION! Interrupting this process may leave the system in an unstable state. Allow the software to complete the backup and recovery process. This may take up to 20 minutes depending on the system configuration.

Press C to Continue or E to Exit: _

CAUTION

Never turn off the power during the system recovery because doing so may cause serious damage to the E5070B/E5071B.

- Step 10.** The factory recovery will be complete in about 5 minutes. When the factory recovery is complete, the message as shown below appears. Press **Ctrl**, **Alt**, and **Delete** of the keyboard at the same time to restart.

Remove the disk and Press CLT+ALT+DEL to restart your system.

NOTE

If the above message does not appear, the instrument is at fault; contact your local Agilent customer center listed at the end of this manual or distributor.

- Step 11.** After restart, the screen for initial registration appears. Execute initial registration. For information on the execution procedure, refer to *Installation/Quick Start Guide*.
- Step 12.** For the E5070B/E5071B equipped with the Option 016 touch screen, execute the calibration of the touch screen. For information on the execution procedure, refer to “Calibration of the Touch Screen” on page 470.

Procedure to create the user backup image (2)

This procedure is valid for the E5070B : MY42300633, and above, E5071B : Y42301397 and above. If your unit doesn't follow the procedure written below, please refer to "Procedure to create the user backup image (1)" on page 455 for the detail.

This section describes how to create the user backup image. The C drive contents saved in this creation are recalled when the user recovery function is executed.

NOTE This function is available when the volume label on the hard disk is CP600 or higher.

NOTE You need the keyboard for this operation.

- Step 1.** Shut down the E5070B/E5071B.
- Step 2.** Connect the keyboard to the E5070B/E5071B.
- Step 3.** Insert the disk for the system recovery into the floppy disk drive of the E5070B/E5071B.
- Step 4.** Press the standby switch of the E5070B/E5071B to turn it on.
- Step 5.** When the screen as shown in the figure below appears, press and hold  of the keyboard until this screen disappears.

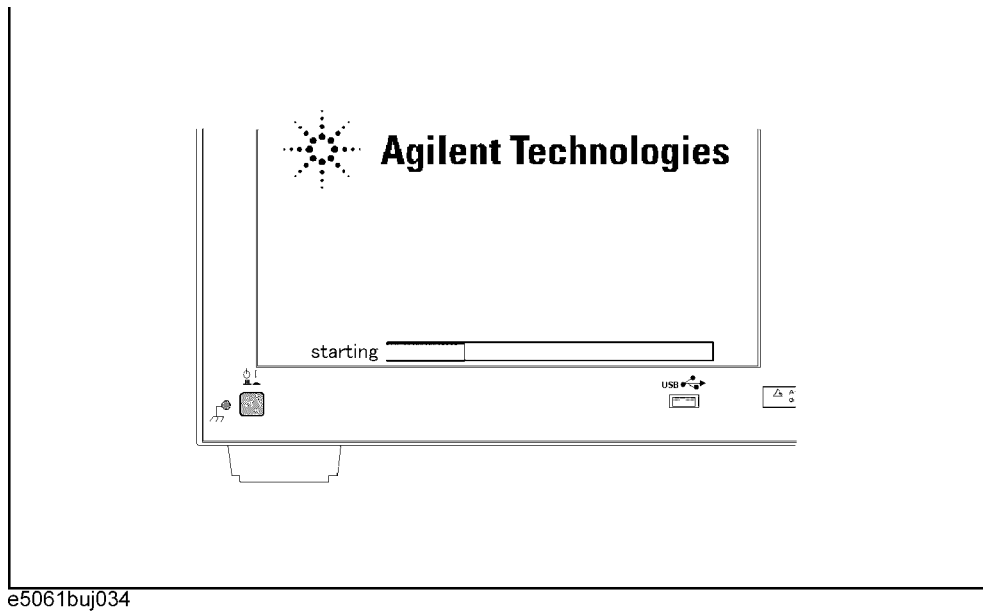

NOTE After several seconds, the next screen appears automatically even if you do not press any key, so do not miss it.

If the above message does not appear, the instrument is at fault; contact your local Agilent customer center listed at the end of this manual or distributor.

Step 6. The following screen appears. Select “+Removable Devices” with of the keyboard, and press of the keyboard.

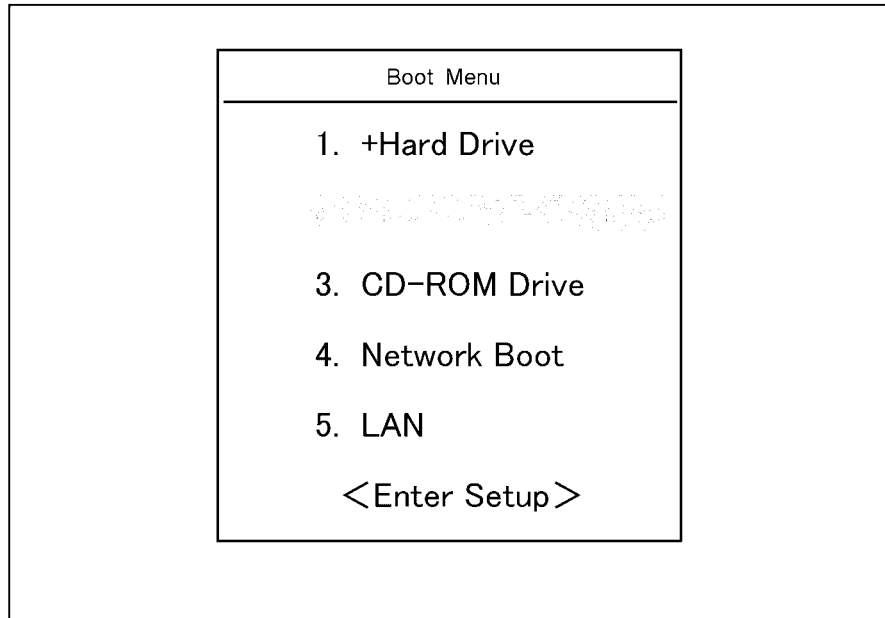

Step 7. The message as shown below appears. Press of the keyboard. If you want to cancel the create user backup image, press here.

```
Agilent Technologies System Utilities
Recovery & Backup Options for the E5070/71B
```

Choose One of the following:

-
1. Recover Factory Backup Image
 2. Create User Backup Image
 3. Recover User Backup Image
 4. Exit
-

Enter a Choice: _

NOTE

If the above message does not appear, the instrument or the disk for the system recovery is at fault; contact your local Agilent customer center listed at the end of this manual or distributor.

Setting and Using the Control and Management Functions

System Recovery

- Step 8.** The message as shown below appears. Press **C** of the keyboard. If you want to cancel the create user backup image, press **E** here.

You chose to create a backup image file of your system.

The system will perform a quick integrity check of the file structure on the C: Drive. It will then copy the C: partition to an image file and store it on the System Recovery partition.

Press C to Continue or E to Exit: _

- Step 9.** The message as shown below appears. Press **C** of the keyboard to start the create user backup image. If you want to cancel the create user backup image, press **E** here.

CAUTION! Interrupting this process may leave the system in an unstable state. Allow the software to complete the backup and recovery process. This may take up to 20 minutes depending on the system configuration.

Press C to Continue or E to Exit: _

CAUTION

Never turn off the power during the create user backup image because doing so may cause serious damage to the E5070B/E5071B.

- Step 10.** The create user backup image will be complete in about 5 minutes. When the create user backup image is complete, the message as shown below appears. Press **Ctrl**, **Alt**, and **Delete** of the keyboard at the same time to restart.

Remove the disk and Press CLT+ALT+DEL to restart your system.

NOTE

If the above message does not appear, the instrument is at fault; contact your local Agilent customer center listed at the end of this manual or distributor.

Procedure to execute the user recovery function (2)

This procedure is valid for the E5070B : MY42300633, and above, E5071B : Y42301397 and above. If your unit doesn't follow the procedure written below, please refer to "Procedure to execute the user recovery function (1)" on page 458 for the detail.

Returns the contents of the C drive to a user-specified state. To use this function, you must create the user backup image in advance. For more information, see the description "Procedure to create the user backup image (1)" on page 455.

NOTE This function is available when the volume label on the hard disk is CP600 or higher.

NOTE You need the keyboard for this operation.

- Step 1.** Shut down the E5070B/E5071B.
- Step 2.** Connect the keyboard to the E5070B/E5071B.
- Step 3.** Insert the disk for the system recovery into the floppy disk drive of the E5070B/E5071B.
- Step 4.** Press the standby switch of the E5070B/E5071B to turn it on.
- Step 5.** When the screen as shown in the figure below appears, press and hold  of the keyboard until this screen disappears.

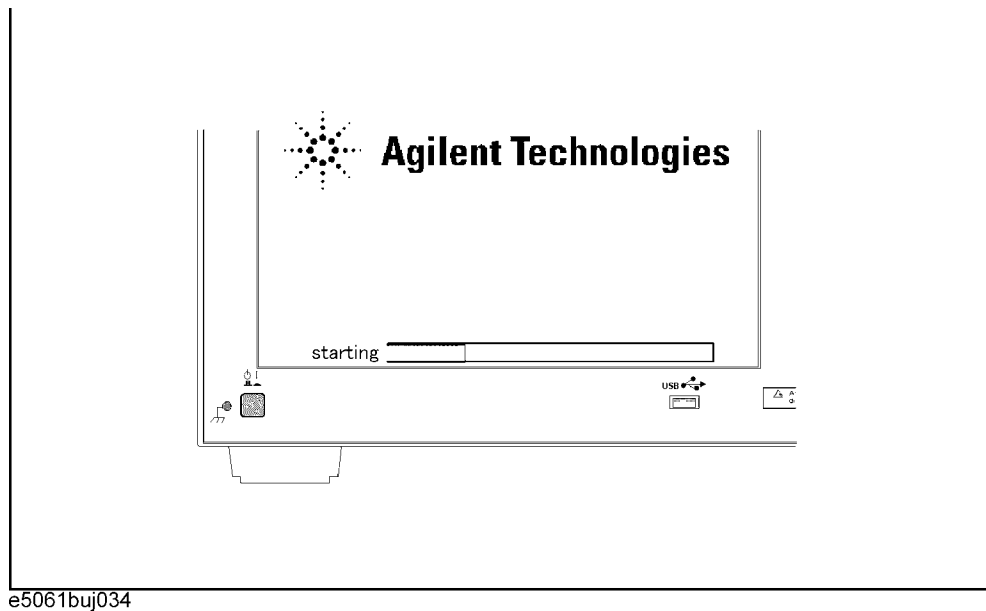

NOTE After several seconds, the next screen appears automatically even if you do not press any key, so do not miss it.

If the above message does not appear, the instrument is at fault; contact your local Agilent customer center listed at the end of this manual or distributor.

Setting and Using the Control and Management Functions

System Recovery

Step 6. The following screen appears. Select “+Removable Devices” with of the keyboard, and press of the keyboard.

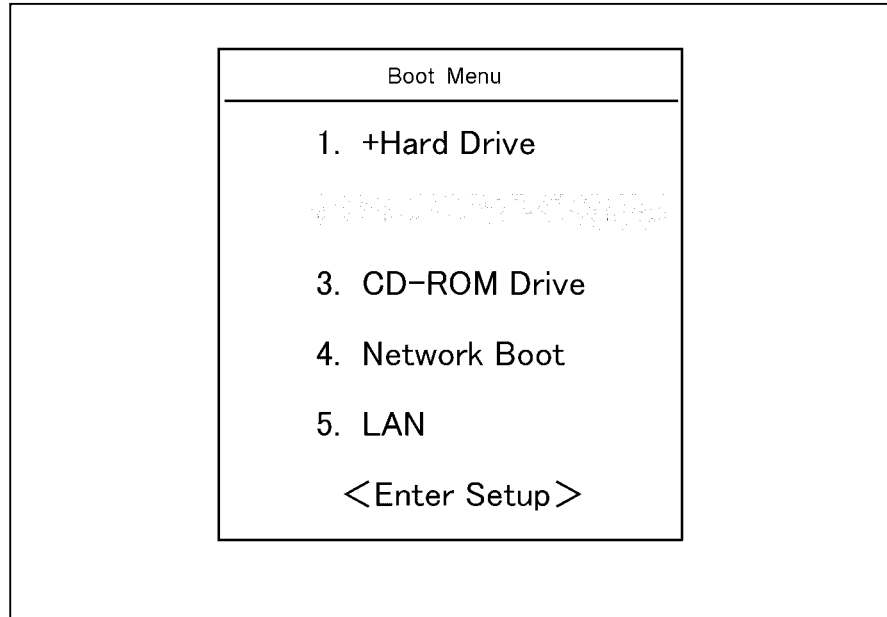

Step 7. The message as shown below appears. Press of the keyboard. If you want to cancel the user recovery, press here.

```

Agilent Technologies System Utilities
Recovery & Backup Options for the E5070/71B

```

Choose One of the following:

-
1. Recover Factory Backup Image
 2. Create User Backup Image
 3. Recover User Backup Image
 4. Exit
-

Enter a Choice: _

NOTE

If the above message does not appear, the instrument or the disk for the system recovery is at fault; contact your local Agilent customer center listed at the end of this manual or distributor.

- Step 8.** The message as shown below appears. Press **C** of the keyboard. If you want to cancel the user recovery, press **E** here.

You chose to recover your own system backup image file.

WARNING: Press C to Continue only if you are sure that you want to proceed. The C: partition will be completely overwritten with no chance of recovering any data. Use Option 3 to recover the system from a serious malfunction caused by corrupted or inadvertently deleted files on the system's primary C: partition.

Press C to Continue or E to Exit: _

- Step 9.** The message as shown below appears. Press **C** of the keyboard to start the user recovery. If you want to cancel the user recovery, press **E** here.

CAUTION! Interrupting this process may leave the system in an unstable state. Allow the software to complete the backup and recovery process. This may take up to 20 minutes depending on the system configuration.

Press C to Continue or E to Exit: _

CAUTION

Never turn off the power during the system recovery because doing so may cause serious damage to the E5070B/E5071B.

- Step 10.** The user recovery will be complete in about 5 minutes. When the user recovery is complete, the message as shown below appears. Press **Ctrl**, **Alt**, and **Delete** of the keyboard at the same time to restart.

Remove the disk and Press CLT+ALT+DEL to restart your system.

NOTE

If the above message does not appear, the instrument is at fault; contact your local Agilent customer center listed at the end of this manual or distributor.

Calibration of the Touch Screen

When you have executed system recovery on the E5070B/E5071B equipped with an Option 016 touch screen, you have to calibrate the touch screen. Follow the procedure described below to calibrate the touch screen.

- Step 1.** Press **System**.
- Step 2.** Press **Service Menu**.
- Step 3.** Press **Test Menu**.
- Step 4.** Press **Adjust Touch Screen**.

The touch screen calibration screen (Figure 13-23) appears.

Figure 13-23

Touch Panel Calibration Screen

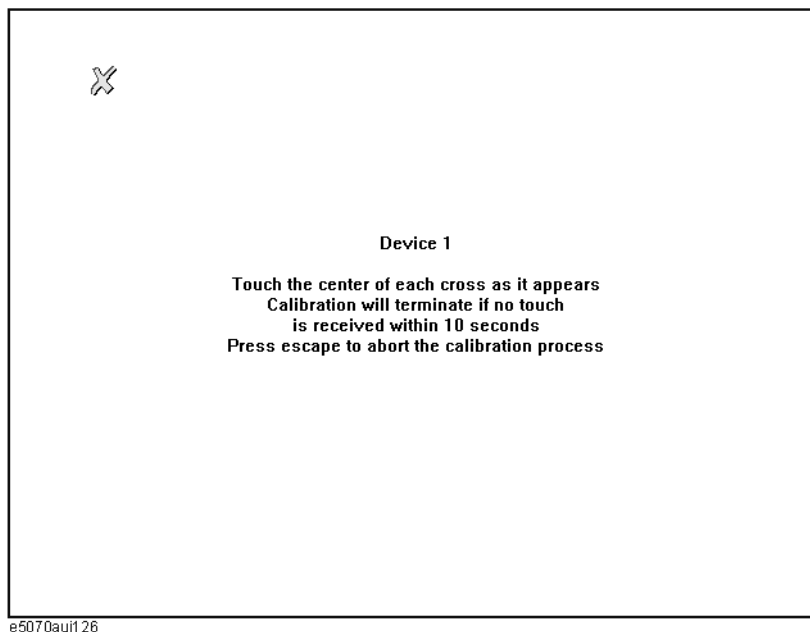

- Step 5.** Touch the x mark on the upper left with your finger. The mark x appears also on the lower left, upper right, and lower right. Touch the x marks in that order with your finger.

Touching the four locations described above with your finger automatically concludes the touch screen calibration.

NOTE

With no operation on the touch screen calibration screen for a preset time, it automatically closes and the previous measurement screen reappears.

Initial Source Port Control function

Firmware Rev. A.03.54 and later provides an additional feature, "Initial Source Port Control." It protects the output amplifier inside the instrument against any potential damage due to transient voltage that may be externally applied. After the firmware is installed, this feature is activated at power-on. When activated, this feature attenuates the output signal and turns off the test port LED each time a sweep finishes. At the same time, it switches the stimulus signal output test port in the trigger hold state to a pre-selected test. A test port 1 is selected at power-on.

The Init Src Ctrl feature lets you select the stimulus signal output test port in the trigger hold state. By setting the stimulus signal output test port to a test port which hardly experience transient voltage, this feature can reduce the possibility that the output amplifiers of the instrument may be damaged by transient voltage. Transient voltage occurs when the active DUT is connected or an external DC power supply is turned on. A test port not used or a test port to which the DUT input terminal is connected can be regarded as a test port which hardly experience transient voltage. The following table shows the degree of tolerance to transient voltage of each test with this feature. Connect the DUT so that transient voltage is not applied to test ports with low tolerance.

Table 13-4

Test Port to select (Stimulus signal output test port)	Low tolerance test ports Connected to the instrument's output amplifier.(Recommended connection: test port not used or DUT input terminal)	High tolerance test ports connected to 50W termination inside the instrument.(Recommended connection: DUT output terminal)
When test port 1 is selected	Test port 1, test port 3	Test port 2, test port 4
When test port 2 is selected	Test port 2, test port 3	Test port 1, test port 4
When test port 3 is selected	Test port 3, test port 1	Test port 2, test port 4
When test port 4 is selected	Test port 4, test port 1	Test port 2, test port 3

We recommended you to use this feature in single measurement (when performing manual measurement) or :INIT:CONT OFF (when using a program) since the stimulus signal output destination is switched to the selected test port only in the trigger hold state

Usage:

(When performing manual measurement)

Trigger: **Trigger** -Single is recommended.

Turning on the Init Src Ctrl feature: **System** -Service-Init Src Ctrl [ON]

Specifying the Init Src port: **System** -Service-Init Src Port [1|2|3|4]

(When using a SCPI program. Sample program to set Port 1 to Initial Source Port.)

:INIT:CONT OFF

:SYSTem:ISPControl[:STATe] ON

:SYSTem:ISPControl:PORT 1

Setting and Using the Control and Management Functions
Initial Source Port Control function

To disable the Initial Source Port Control feature (applicable to Rev.A.03.54 and later):

When using the front panel menu - Service-Init Src Ctrl [OFF]

When using the SCPI command - SYSTem:ISPControl[:STATe] OFF

When using the VBA command - SCPI.SYSTem.ISPControl.STATe = False

This chapter explains how to control the E5091A multiport test set.

Connecting E5070B/E5071B and E5091A

Required devices

The devices required to connect the E5070B/E5071B to the E5091A are listed below.

- E5070B/E5071B
- E5091A
- N-type to N-type cable (supplied with the E5091A, Agilent part number: 8120-4782)
- USB cable (supplied with the E5091A, Agilent part number: 8121-0770)

Connecting E5070B/E5071B and E5091A

As shown in Figure 14-1, connect the USB cable between the rear panel of the E5070B/E5071B and that of the E5091A.

Figure 14-1

Connection between E5070B/E5071B and E5091A (rear view)

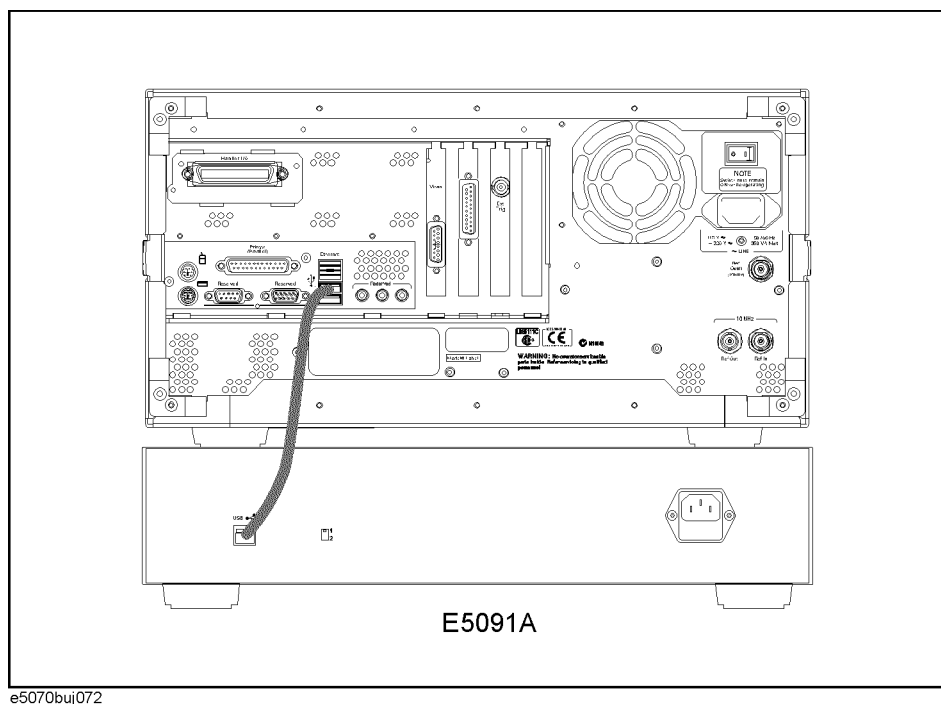

NOTE

Do not switch on/off devices connected via the USB ports (front or rear panel) or connect/disconnect devices to the USB ports while the E5070B/E5071B is measuring with the E5091A.

As shown in Figure 14-2, connect the N-type cable between the front panel of the E5070B/E5071B and that of the E5091A. Make the connection so that the numbers of the test ports of the E5070B/E5071B and those of the interconnection ports of the E5091A match.

Figure 14-2 Connection between E5070B/E5071B and E5091A (front view)

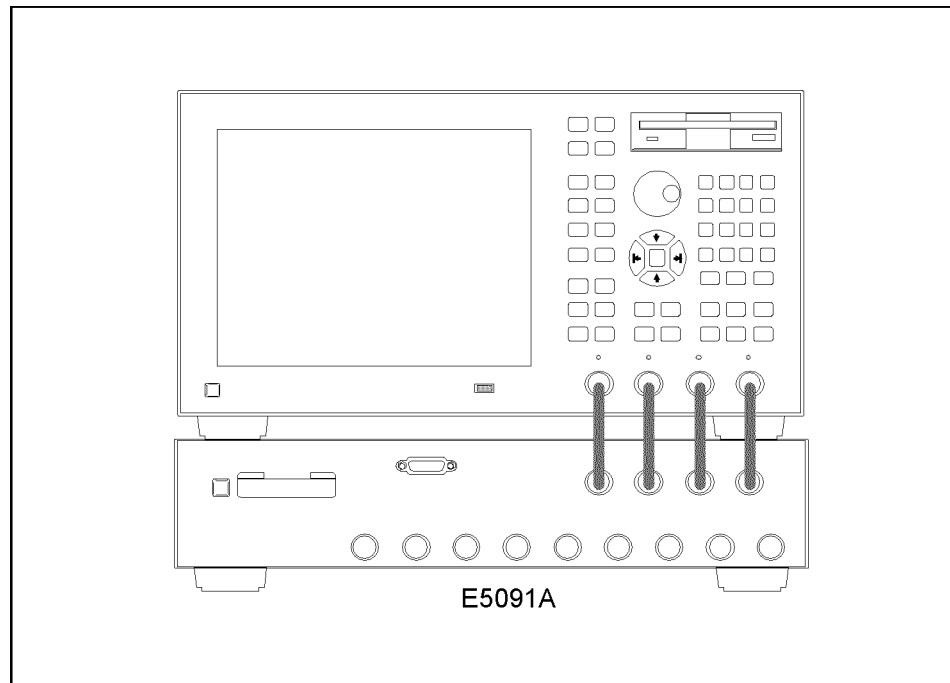

e5070auj189

Powering on

After connecting the E5070B/E5071B and the E5091A, follow these steps to power both devices on.

- Step 1.** Turn on the E5070B/E5071B and the E5091A.
- Step 2.** Immediately after power-on, all of the port connection indicator LEDs of the E5091A go on. Then, after the E5070B/E5071B detects the E5091A, the LEDs that indicate the connected test ports remain on.

NOTE

If the E5070B/E5071B is not powered on or if the E5070B/E5071B and the E5091A are not connected via the USB cable, all of the LEDs stay on.

Setting the E5091A

This section describes the settings of the E5091A. Table 14-1 shows the flow used for item setting.

Table 14-1 Setting flow for E5091A

Item	Description
“Selecting ID for E5091A” on page 476	Selects the ID of the E5091A you want to set
“Selecting the E5091A Model” on page 477	Selects the E5091A model you want to set
“Assigning test ports” on page 477	Assigns test ports of the E5070B/E5071B and those of the E5091A
“Displaying the E5091A properties” on page 479	Displays the E5091A property to check the port setting
“Setting control line” on page 480	Makes the setting of the control line that controls the DUT
“Enabling control of E5091A” on page 481	Enables functions to control the E5091A

Selecting ID for E5091A

Set the target ID to the ID of the connected E5091A.

- Step 1.** Press **[System]** - **Multiport Test Set Setup** to display the E5091A setup menu.
- Step 2.** Select **Test Set 1** for ID 1 and **Test Set 2** for ID 2. The ID is set with the bit switch on the rear panel of the E5091A (Figure 14-3).

NOTE Change the ID bit switch setting while the E5070B/E5071B is turned off.

Figure 14-3 ID bit switch of E5091A

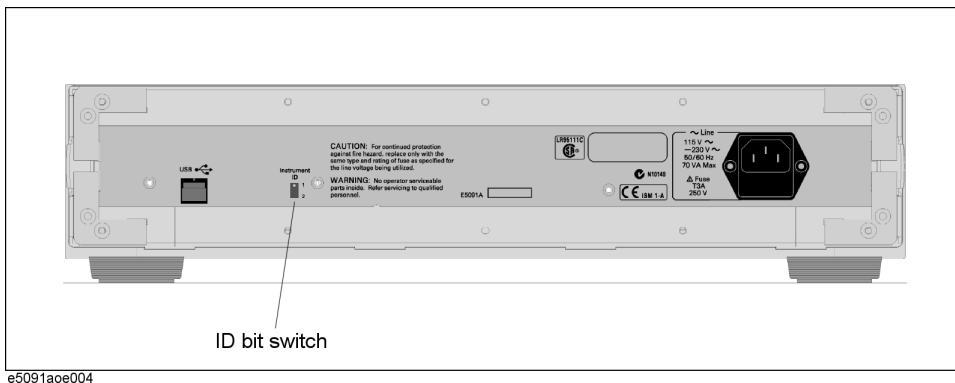

e5091a0e004

Selecting the E5091A Model

Select the E5091A model you want to set. For the E5091A-016, you can select the 13-port device or 16-port device function.

Softkey	Model
E5091_9	Select the E5091A option 009.
E5091_13	Select the E5091A option 016 for the 13-port device function.
E5091_16	Select the E5091A option 016 for the 16-port device function.

- Step 1.** Press **[System]** - **E5091A Setup** to display the E5091A setup menu.
- Step 2.** After the execution of “Selecting ID for E5091A” on page 476, select the model by pressing **Select Test Set**.

NOTE

If the model you use and the selected softkey is different, the configuration will not be reflected. Also, no error message will appear. For the correlation between the model and the softkey, refer to the Table 14-2.

Table 14-2

The Model you use and the softkey you select

	E5091_009	E5091_013	E5091_016
E5091A-009	Yes	No	No
E5091A-016	No	Yes	Yes

Assigning test ports

Before calibration and measurement, you need to assign the test ports of the E5091A. You can set the connection ports for each channel and perform measurement while switching the connection for each channel.

Operational procedure

- Step 1.** Press **[System]** - **Multiport Test Set Setup** to display the E5091A setup menu.
- Step 2.** Press **[Channel Next]** (or **[Channel Prev]**) to activate the channel for which you want to set the connection ports.
- Step 3.** Use the corresponding softkey to assign the test ports for the connection between the E5091A and the interconnection ports.

NOTE

The port name of the softkey indicates the E5091A interconnection port.

Table 14-3

When the E5091A-009 is Connected

Softkey	Function
Port1	Selects a test port of the E5091A to which you want to connect port 1 of the E5091A. You can select the port from A or T1 *1.

Controlling E5091A
Setting the E5091A

Table 14-3 When the E5091A-009 is Connected

Softkey	Function
Port2	Selects a test port of the E5091A to which you want to connect port 2 of the E5091A. You can select the port from T1 * ¹ or T2 .
Port3	Selects a test port of the E5091A to which you want to connect port 3 of the E5091A. You can select the port from R1+ , R2+ , or R3+ .
Port4	Selects a test port of the E5091A to which you want to connect port 4 of the E5091A. You can select the port from R1- , R2- , or R3- .

*1. If port T1 has already been assigned to port 2 when you try to assign port T1 to port 1, port T2 is automatically assigned to port 2. If port T1 has already been assigned to port 1 when you try to assign port T1 to port 2, port A is automatically assigned to port 1.

Table 14-4 When the E5091A-013 is Connected

Softkey	Function
Port1	Selects a test port of the E5091A to which you want to connect port 1 of the E5091A. You can select the port from A1 , T1 , T2 , or T3 .
Port2	Selects a test port of the E5091A to which you want to connect port 2 of the E5091A. You can select the port from T1 , T2 , T3 , or T4 .
Port3	Selects a test port of the E5091A to which you want to connect port 3 of the E5091A. You can select the port from R1+ , R2+ , R3+ , or R4+ .
Port4	Selects a test port of the E5091A to which you want to connect port 4 of the E5091A. You can select the port from R1- , R2- , R3- , or R4- .

Table 14-5 When the E5091A-016 is Connected

Softkey	Function
Port1	Selects a test port of the E5091A to which you want to connect port 1 of the E5091A. You can select the port from A1 , A2 , A3 , A4 , A , T1 , T2 , or T3 .
Port2	Selects a test port of the E5091A to which you want to connect port 2 of the E5091A. You can select the port from B1 , B2 , B3 , B4 , T1 , T2 , T3 , or T4 .
Port3	Selects a test port of the E5091A to which you want to connect port 3 of the E5091A. You can select the port from R1+ , R2+ , R3+ , or R4+ .
Port4	Selects a test port of the E5091A to which you want to connect port 4 of the E5091A. You can select the port from R1- , R2- , R3- , or R4 .
Port5	Selects a test port of the E5091A to which you want to connect port 5 of the E5091A. You can select the port from X1 or X2 .
Port6	Selects a test port of the E5091A to which you want to connect port 6 of the E5091A. You can select the port from Y1 or Y2 .
Port7	Selects a test port of the E5091A to which you want to connect port 7 of the E5091A. You can select the port from Z1 or Z2 .

Step 4. Execute Step. 2 through Step. 3 for all channels for which you want to perform sweep.

NOTE The same test ports cannot be connected to each port. In such a case, the other test ports' settings will be automatically changed.

Displaying the E5091A properties

By displaying the E5091A properties shown in Figure 14-4, you can obtain the assignment information of the test ports for each channel. This is useful when you need to check the test port assignment, for example, when you perform calibration.

Figure 14-4 E5091A properties

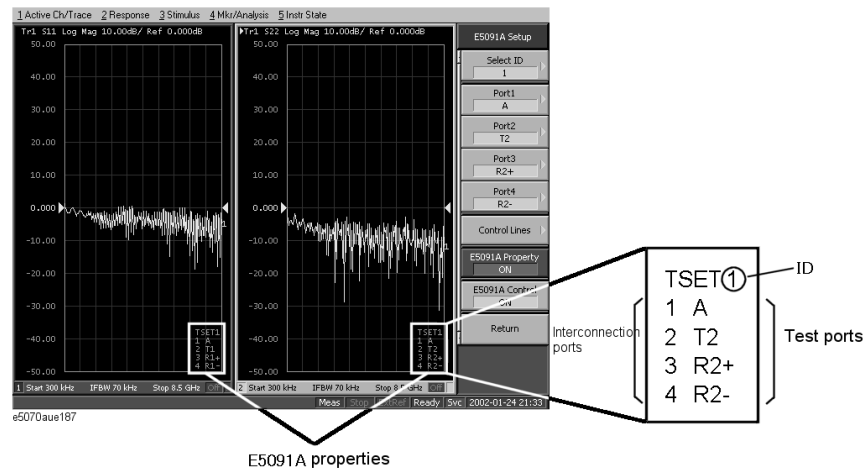

Operational procedure

- Step 1.** Press **[System]** - **Multiport Test Set Setup** to display the E5091A setup menu.
- Step 2.** After the execution of “Selecting ID for E5091A” on page 476 and “Selecting the E5091A Model” on page 477, press **Property** to enable it (**ON**) to display the E5091A’s properties.

NOTE The enable (**ON**)/disable (**OFF**) setting of the E5091A properties display is executed for all channels.

Controlling E5091A Setting the E5091A

Setting control line

The E5070B/E5071B can control the output from the control line (Figure 14-5) of the E5091A and control the DUT (for example, switching the frequency band of the front end module). The procedure is shown below. For the specifications of the DUT control line, refer to *E5091A Users & Service Guide*.

Figure 14-5

Control line

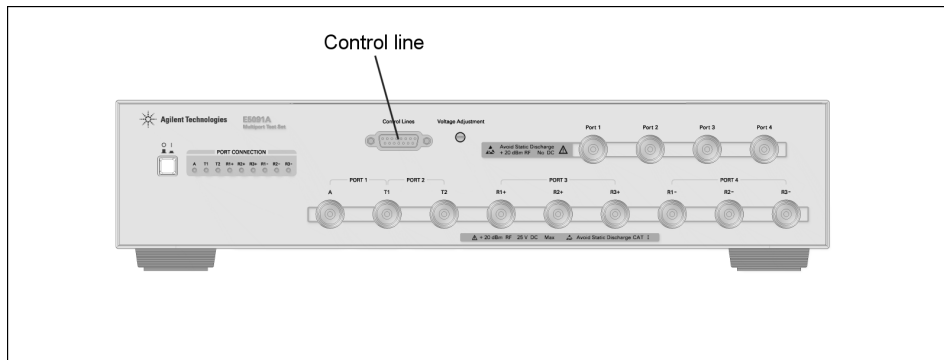

e5070aue188

Operational procedure

- Step 1.** Press **[System]** - **E5091A Setup** to display the E5091A setup menu.
- Step 2.** Press **[Channel Next]** or **[Channel Prev]** to activate the channel for which you want to set the control line.
- Step 3.** After the execution of “Selecting ID for E5091A” on page 476 and “Selecting the E5091A Model” on page 477, press **Control Lines** to display the settings menu for the DUT control line.
- Step 4.** Use the corresponding softkey to set the control line of the E5091A.

Softkey	Function
Line 1, Line 2, Line 3, Line 4, Line 5, Line 6, Line 7, Line 8	Set High/Low of each line of the control line.

- Step 5.** Execute Step. 3 through Step. 4 for all channels that you want to sweep.

Enabling control of E5091A

If you enable control of the E5091A, it becomes possible to switch the measurement path and the output function of the control line of the E5091A during measurement.

NOTE

The E5070B/E5071B needs the additional time (about 3 ms) to control the E5091A when you have enabled control of the E5091A.

Operational procedure

- Step 1.** Press **System** - **Multiport Test Set Setup** to display the E5091A setup menu.
- Step 2.** After the execution of “Selecting ID for E5091A” on page 476 and “Selecting the E5091A Model” on page 477, press **Control** to enable (**ON**) control of the E5091A.

NOTE

The enable (**ON**)/disable (**OFF**) setting of the control function of the E5091A is executed for all channels.

Calibration

Follow these steps to perform calibration with the E5091A connected:

- Step 1.** Press **Channel Next** (or **Channel Prev**) to set the channel that you want to calibrate to the active channel.
- Step 2.** Follow “Displaying the E5091A properties” on page 479 to display the E5091A properties.
- Step 3.** According to the procedures in Chapter 4, “Calibration,” on page 93, perform the calibration. Check the corresponding E5091A test ports shown in the calibration properties as the port names of the E5070B/E5071B are displayed on the calibration menu, connect the calibration standard to the corresponding test ports of the E5091A, and perform the calibration.

Performing Measurement

Trigger state and switching the setting of the E5091A

The following table shows how the setting in the E5091A is switched from when the trigger state is the stop state. For more information on the trigger state, refer to *E5070B/E5071B Programmers Guide*.

Trigger state	Switching the setting of E5091A
Stop	The setting is not switched.
Trigger wait	<p>The setting of the internal switch and the output of the control line are switched according to the setting of the channel swept first.</p> <p>The connections of the test ports and the output of the control line are switched according to the setting of the channel swept first.</p>
Measurement	<p>Measurement is performed following the procedure below.</p> <p>Execute a sweep for the first channel.</p> <p style="text-align: center;">↓</p> <p>Set the connections of the test ports and the output of the control line according to the settings of the channel swept second.</p> <p style="text-align: center;">↓</p> <p>Execute a sweep for the second channel.</p> <p style="text-align: center;">↓</p> <p style="text-align: center;">⋮</p> <p style="text-align: center;">↓</p> <p>Set the connections of the test ports and the output of the control line according to the setting of the channel swept last.</p> <p style="text-align: center;">↓</p> <p>Execute a sweep for the last channel.</p>
Stop or trigger wait	The setting is not switched for the stop state; it is switched for the trigger wait state.

Operation

Perform operations by referring to Chapter 5, “Making Measurements,” on page 241.

Connecting Two E5091As

Give consideration to the following items when you make measurements by using two E5091As.

- Set their IDs to different values. The instruments will not work correctly if their IDs are the same.
- Connect calibration standards and the DUT only after confirming the connection and port assignment of the E5091As.

15 Measurement Examples

This chapter introduces examples of actual device measurements made by using the Agilent E5070B/E5071B.

Measuring the SAW Bandpass Filter Using the Segment Sweep

This section illustrates how to use the segment sweep function to evaluate a SAW bandpass filter with a center frequency of 947.5 MHz.

Evaluation Steps

Here, the DUT is evaluated by following the steps described in Table 15-1.

Table 15-1 Evaluating the DUT Using the Segment Sweep

Step	Description
“1. Determine the Segment Sweep Conditions” on page 487	The segment sweep conditions are determined according to the characteristics of the DUT.
“2. Create a Segment Sweep Table” on page 488	The segment sweep conditions are entered in the E5070B/E5071B.
“3. Select the Segment Sweep as the Sweep Type” on page 490	The segment sweep is selected as the sweep type.
“4. Execute the Calibration” on page 490	A 2-port ECal is performed between the test ports connecting the DUT.
“5. Connect the DUT” on page 491	The DUT is connected.
“6. Execute the Measurement” on page 491	A trigger is applied to perform the measurement.
“7. Define the Setup for Display” on page 491	The choice is made between frequency base and order base as the method of displaying segments.

1. Determine the Segment Sweep Conditions

Figure 15-1 shows the results of evaluating the transmission characteristics of the SAW bandpass filter in the range of 440 MHz to 3 GHz by using the linear sweep.

Figure 15-1

Transmission characteristics of SAW bandpass filter (440 MHz to 3 GHz, linear sweep)

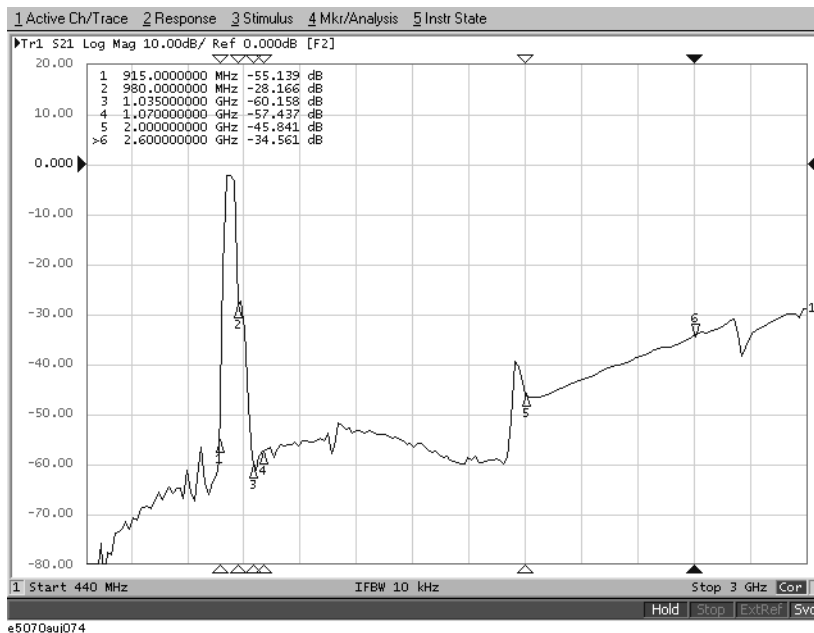

The measurement conditions are determined for each frequency range. Here, the segment sweep is performed following the sweep conditions shown in Table 15-2.

Table 15-2

Determining Sweep Conditions (using markers shown in Figure 15-1)

Frequency Range		Measurement Conditions	
Start	Stop	Number of Points	IF Bandwidth
440 MHz	915 MHz (Marker 1)	47	70 kHz
915 MHz (Marker 1)	980 MHz (Marker 2)	130	100 kHz
980 MHz (Marker 2)	1.035 GHz (Marker 3)	55	70 kHz
1.07 GHz (Marker 4)	2 GHz (Marker 5)	93	70 kHz
2.6 GHz (Marker 6)	3 GHz	41	70 kHz

2. Create a Segment Sweep Table

Follow the steps below to make entries in the segment sweep table.

Step 1. Display the segment table.

Setup Description	Key Operation
Presetting	<input type="button" value="Preset"/> - OK
Displaying the segment table	<input type="button" value="Sweep Setup"/> - Edit Segment Table

Step 2. Display the IF bandwidth setting column in the segment table.

Setup Description	Key Operation
Moving the focus to the softkey menu	<input type="button" value="Focus"/>
Display of IF bandwidth setting column: ON	List IFBW (turn it ON)

NOTE

When setup items (power level, delay time, sweep mode, and sweep time in this case) are not displayed in the segment table, the setting for the channel in use applies to all segments.

Step 3. Enter the setup data in the segment table.

Setup Description	Key Operation
Moving the focus to the segment table (select)	<input type="button" value="Focus"/>
Segment 1	
Start frequency: 440 MHz	<input type="button" value="4"/> <input type="button" value="4"/> <input type="button" value="0"/> <input type="button" value="M/μ"/>
Stop frequency: 915 MHz	<input type="button" value="9"/> <input type="button" value="1"/> <input type="button" value="5"/> <input type="button" value="M/μ"/>
Number of points: 47	<input type="button" value="4"/> <input type="button" value="7"/> <input type="button" value="x1"/>
IF bandwidth: 70 kHz	<input type="button" value="7"/> <input type="button" value="0"/> <input type="button" value="k/m"/>
Segment 2	
Start frequency: 915 MHz	<input type="button" value="9"/> <input type="button" value="1"/> <input type="button" value="5"/> <input type="button" value="M/μ"/>
Stop frequency: 980 MHz	<input type="button" value="9"/> <input type="button" value="8"/> <input type="button" value="0"/> <input type="button" value="M/μ"/>
Number of points: 130	<input type="button" value="1"/> <input type="button" value="3"/> <input type="button" value="0"/> <input type="button" value="x1"/>
IF bandwidth: 100 kHz	<input type="button" value="1"/> <input type="button" value="0"/> <input type="button" value="0"/> <input type="button" value="k/m"/>
Segment 3	
Start frequency: 980 MHz	<input type="button" value="9"/> <input type="button" value="8"/> <input type="button" value="0"/> <input type="button" value="M/μ"/>
Stop frequency: 1.035 GHz	<input type="button" value="1"/> <input type="button" value="."/> <input type="button" value="0"/> <input type="button" value="3"/> <input type="button" value="5"/> <input type="button" value="G/n"/>

Setup Description	Key Operation
Number of points: 55	5 5 x1
IF bandwidth: 70 kHz	7 0 k/m
Segment 4	
Start frequency: 1.07 GHz	1 . 0 7 G/n
Stop frequency: 2 GHz	2 G/n
Number of points: 93	9 3 x1
IF bandwidth: 70 kHz	7 0 k/m
Segment 5	
Start frequency: 2.6 GHz	2 . 6 G/n
Stop frequency: 3 GHz	3 G/n
Number of points: 41	4 1 x1
IF bandwidth: 70 kHz	7 0 k/m

Figure 15-2

Completed segment table

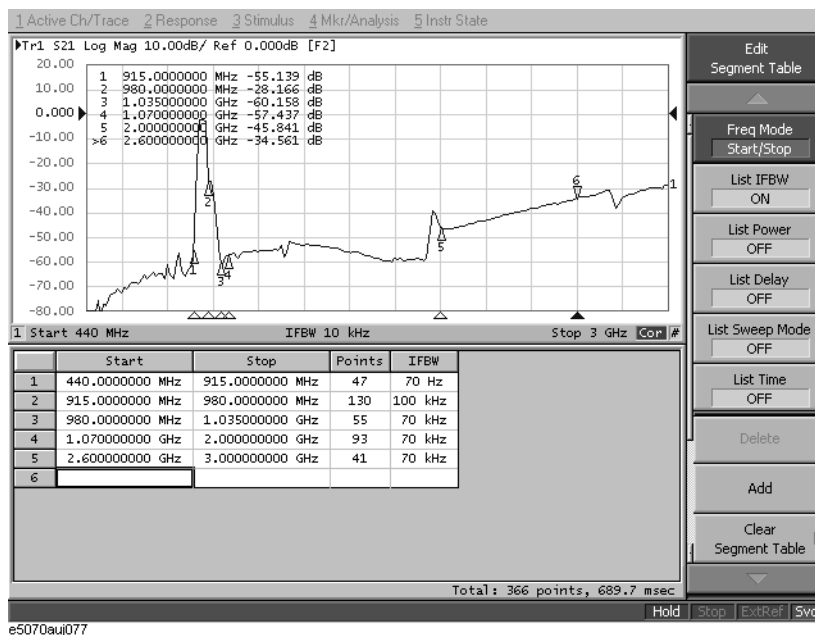

3. Select the Segment Sweep as the Sweep Type

The segment sweep is selected as the sweep type.

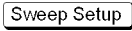
Setup Description	Key Operation
Sweep type: Segment sweep	 - Sweep Type - Segment

4. Execute the Calibration

In this step, a 2-port ECal is executed on the two ports to be used.

Step 1. Connect the ECal module across test ports 1 and 2.

Figure 15-3 Connecting the ECal module

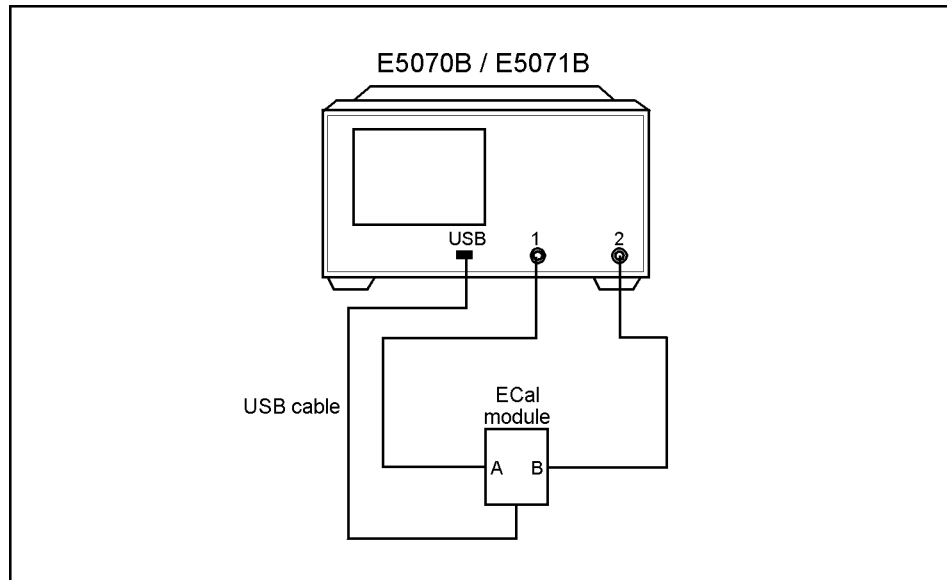

Step 2. Execute the 2-port ECal.

Setup Description	Key Operation
Executing a 2-port ECal between test ports 1 and 2	 - ECal - 2 Port ECal - 1-2

5. Connect the DUT

The DUT is connected across test ports 1 and 2.

Figure 15-4

Connecting the DUT

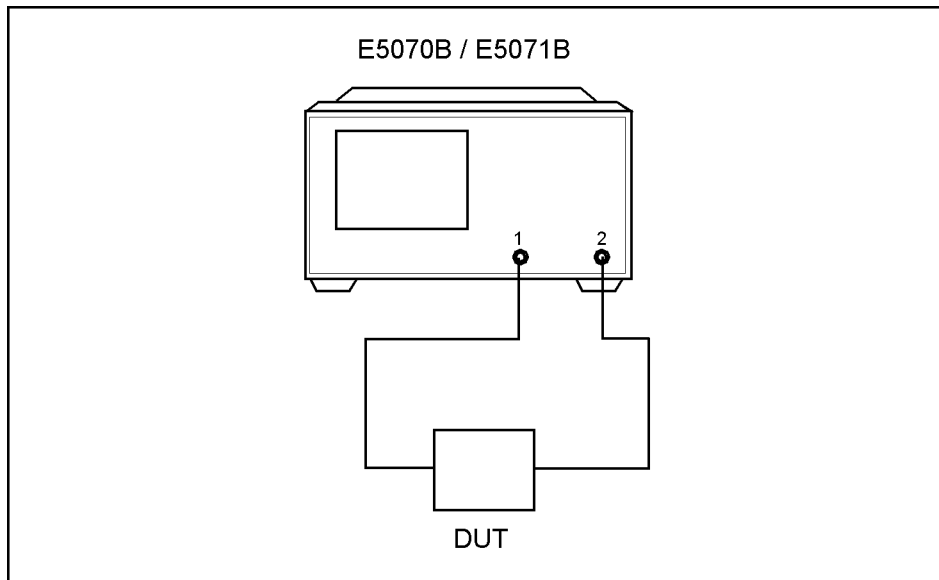

e5070bu022

6. Execute the Measurement

A trigger is applied to perform the measurement.

Setup Description	Key Operation
Trigger mode: Single	Trigger - Single (Or Continuous)

7. Define the Setup for Display

The choice is made between frequency base and order base as the segment display mode.

Setup Description	Key Operation
Segment display: Frequency base or order base	Sweep Setup - Segment Display - Frequency Base Order Base

Measurement Examples
Measuring the SAW Bandpass Filter Using the Segment Sweep

Figure 15-5

Segment display: frequency base

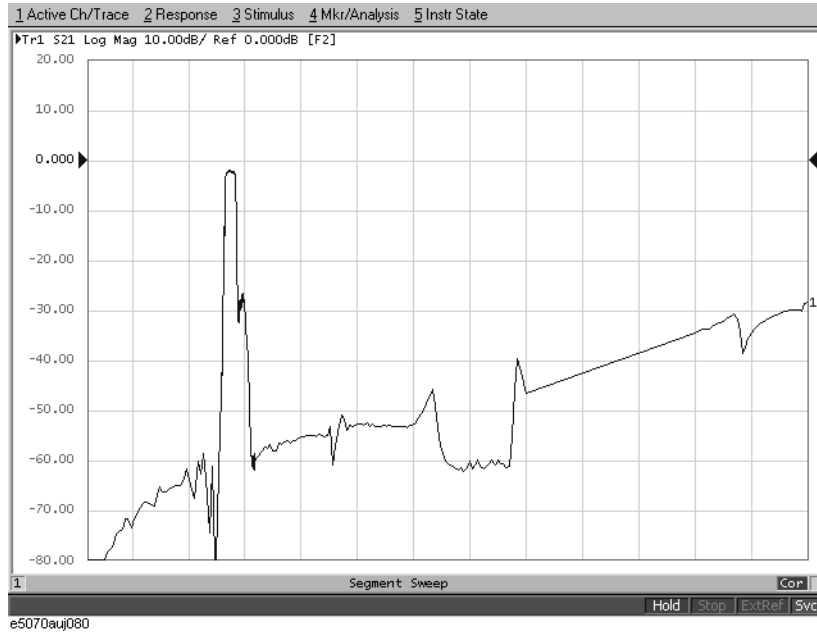
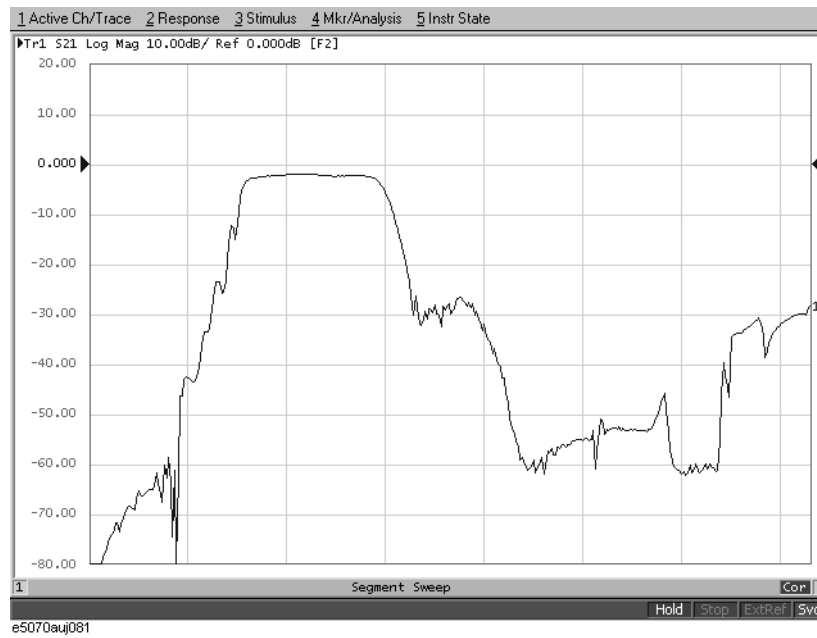

Figure 15-6

Segment display: order base



Evaluating a Duplexer

This section illustrates how to evaluate a duplexer (Tx center frequency: 1.88 GHz, Rx center frequency: 1.96 GHz).

Evaluation Steps

Here, the DUT is evaluated by following the steps described in Table 15-3.

Table 15-3 Evaluating the DUT Using the Segment Sweep

Step	Description
“1. Determine the Segment Sweep Conditions” on page 493	Segment sweep conditions are determined according to the characteristics of the DUT.
“2. Create a Segment Sweep Table” on page 494	The segment sweep conditions are entered in the E5070B/E5071B.
“3. Select the Segment Sweep as the Sweep Type” on page 495	The segment sweep is selected as the sweep type.
“4. Execute the Calibration” on page 495	A full 3-port calibration is executed by using the 2-port ECal module.
“5. Connect the DUT” on page 497	The DUT is connected.
“6. Define the Setup for Display” on page 498	The number of traces to be displayed, split display, and measurement parameters are specified.
“7. Execute the Measurement” on page 498	A trigger is applied to execute the measurement.
“8. Define the Setup for the Segment Display and Scale” on page 498	The setup for segment display and for the scale are defined.
“9. Analyze the Parameters” on page 499	The evaluation parameters for the duplexer are determined.
“10. Define the Setup for a Limit Table” on page 501	The setup for the limit table is defined.
“11. Execute the Limit Test” on page 502	The limit test is executed.

1. Determine the Segment Sweep Conditions

A segment sweep is performed by following the sweep conditions shown in Table 15-4.

Table 15-4 Sweep Conditions

Start	Stop	Number of Points
1.73 GHz	1.83 GHz	50
1.83 GHz	2.03 GHz	400
2.03 GHz	2.13 GHz	50
3.65 GHz	4.03 GHz	38
5.5 GHz	6.02 GHz	52

2. Create a Segment Sweep Table

Entries are made in the segment sweep table following the steps described below.

Step 1. Display the segment table.

Setup Description	Key Operation
Presetting	Preset - OK
Displaying the segment table	Sweep Setup - Edit Segment Table

Step 2. Enter the setup data in the segment table (Figure 15-7).

NOTE

In this step, the IF Bandwidth, power level, delay time, and sweep time are not entered segment by segment. By turning off the display of those parameters on the segment table, you can use, in each segment without making a change, the IF Bandwidth (preset value: 70 kHz) of the channel specified by using **Avg** - **IF Bandwidth**; Power level (preset value: 0 dBm) of the channel specified by using **Sweep Setup** - **Power**; Sweep delay time (preset value: 0 second) of the channel specified by using **Sweep Setup** - **Sweep Delay**; Sweep mode (preset value: Stepped mode) of the channel specified by using **Sweep Setup** - **Sweep Mode**; and Sweep time (preset value: Automatic) of the channel specified by using **Sweep Setup** - **Sweep Time**.

Figure 15-7

Completed segment table

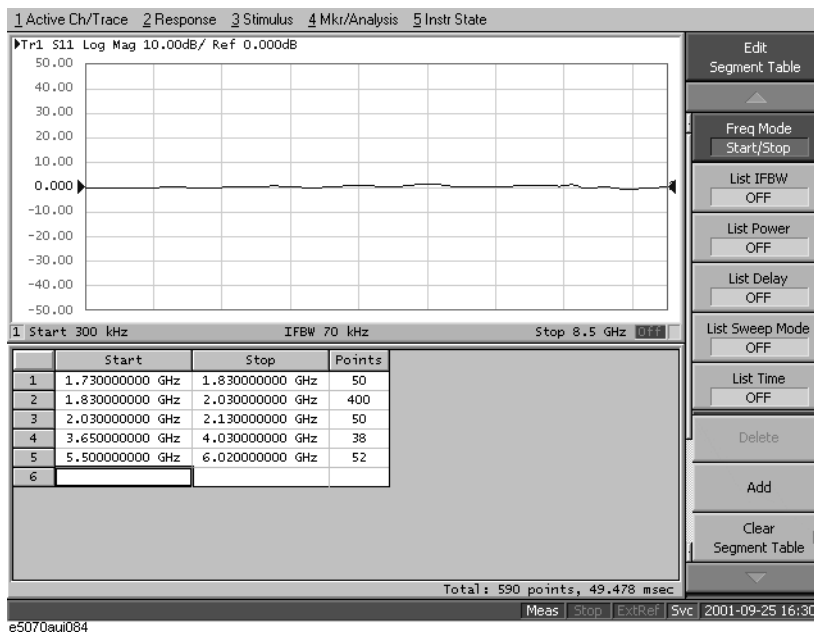

3. Select the Segment Sweep as the Sweep Type

The segment sweep is selected as the sweep type.

Setup Description	Key Operation
Sweep type: Segment sweep	Focus (Moves the focus to the softkey menu) - Return - Sweep Type - Segment (or Sweep Setup - Sweep Type - Segment)

4. Execute the Calibration

In this step, a 2-port ECal module and 3-/4-port module installed in the E5070B/E5071B are used to execute calibration on the three ports used in the measurement.

- Step 1.** Connect the USB port of the 2-port ECal module and the USB port of the E5070B/E5071B with a USB cable. The connection may be made while the unit is powered.
- Step 2.** Load and execute the 3-/4-port ECal programs.

Setup Description	Key Operation
Opening the VBA Project Open dialog box	Macro Setup - Load Project
Loading "ECalAssistant.VBA"	Select "D:\Agilent\ECalAssistant.VBA" and press the Open button.
Executing the program	Macro Run

- Step 3.** The EcalAssistant (start) dialog box appears (Figure 15-8).

Figure 15-8

EcalAssistant (start) dialog box



- Step 4.** Press the **Next** button to display the EcalAssistant (port/channel selection) dialog box (Figure 15-9).

Figure 15-9

EcalAssistant (port/channel selection) dialog box

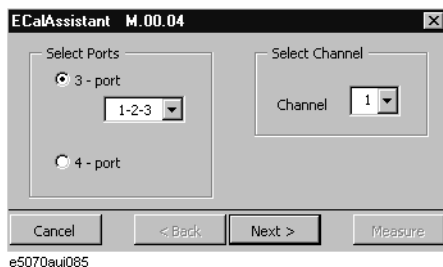

Step 5. Following the instructions in the dialog box, select the type of ECal, test ports, and the channel.

Setup Description	Key Operation
Select Ports	
ECal type: Full 3-port calibration	3 Port
Test ports to be used for ECal: 1, 2, and 3	1, 2, 3
Select Channel	
Channel on which ECal is to be executed: Channel 1	Channel: 1

Step 6. Press the **Next** button. The EcalAssistant (connection) dialog box (Figure 15-10) appears.

Figure 15-10

EcalAssistant (connection) dialog box

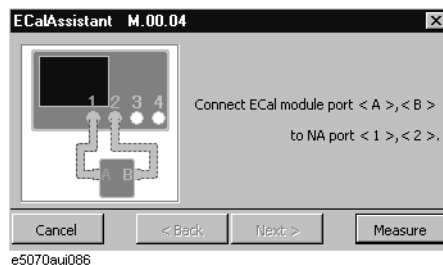

Step 7. Connect the ECal module to the test ports according to the instructions in the dialog box and then press **Measure**.

Setup Description	Key Operation
Executing calibration between ports 1 and 2	(After making the connections shown in Figure 15-11 (a)), press Measure - Next
Executing calibration between ports 1 and 3	(After making the connections shown in Figure 15-11 (b)), press Measure - Next
Executing calibration between ports 2 and 3	(After making the connections shown in Figure 15-11 (c)), press Measure - Next

6. Define the Setup for Display

The setup for display is defined.

Setup Description	Key Operation
Number of traces to be displayed: 5	Display - Number of Traces - 5
Trace placement: Trisected	Allocate Traces - <input type="text" value="x3"/> <input type="text" value=""/>
Measurement Parameter	
Trace 1: S ₁₃	Meas - S13
Trace 2: S ₂₁	Trace Next - Meas - S21
Trace 3: S ₂₃	Trace Next - Meas - S23
Trace 4: S ₃₃	Trace Next - Meas - S33
Trace 5: S ₁₁	Trace Next - Meas - S11

7. Execute the Measurement

A trigger is applied to execute the measurement.

Setup Description	Key Operation
Trigger mode: Single (or continuous)	Trigger - Single (or Continuous)

8. Define the Setup for the Segment Display and Scale

The setup for the scale is defined.

Setup Description	Key Operation
Segment display: Order base	Sweep Setup - Segment Display - Order Base
Reference Line Position	
Trace 1: 10	Trace Next - Scale - Reference Position - <input type="text" value="1"/> <input type="text" value="0"/> <input type="text" value="x1"/>
Trace 2: 10	Trace Next - Reference Position - <input type="text" value="1"/> <input type="text" value="0"/> <input type="text" value="x1"/>
Trace 3: 10	Trace Next - Reference Position - <input type="text" value="1"/> <input type="text" value="0"/> <input type="text" value="x1"/>
Trace 4: 9	Trace Next - Reference Position - <input type="text" value="9"/> <input type="text" value="x1"/>
Trace 5: 9	Trace Next - Reference Position - <input type="text" value="9"/> <input type="text" value="x1"/>

Figure 15-14

Measurement result (segment display: order base)

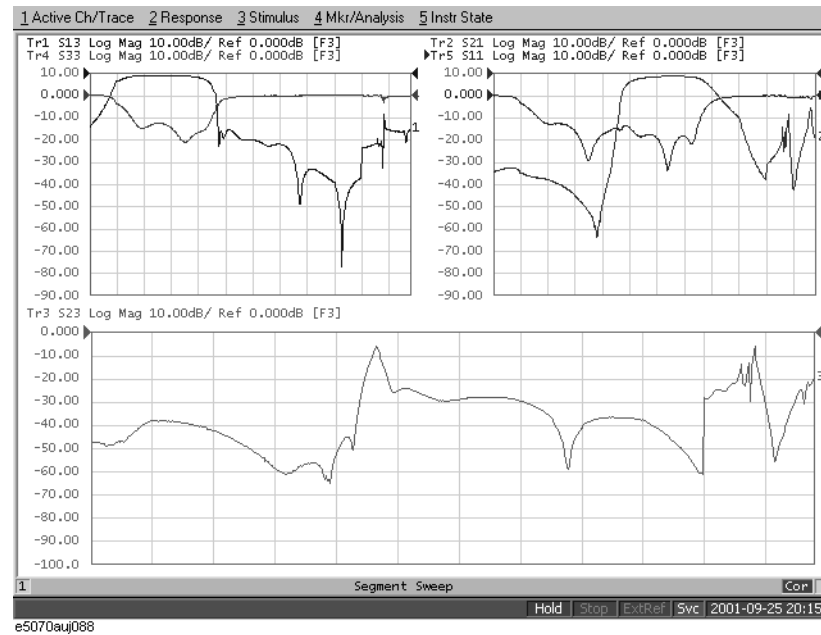

9. Analyze the Parameters

The parameters for the duplexer are determined.

Step 1. Determine the insertion loss and 3-dB bandwidth for Tx.

Setup Description	Key Operation
Marker coupling: OFF	Marker Fctn - Couple (Turn it OFF)
Activating Trace 1	Trace Next
Marker 1: ON	Marker
Search/Tracking: ON	Marker Search - Tracking (Turn it ON)
Moving the marker to the trace maximum	Max
Bandwidth search: ON	Bandwidth (Turn it ON.)

In the example shown in Figure 15-15, insertion loss (**loss**) is 1.243 dB, and the 3-dB bandwidth (**BW**) is 85.53 MHz.

Step 2. Determine the insertion loss and 3-dB bandwidth for the Rx.

Setup Description	Key Operation
Activating Trace 2	Trace Next
Marker 1: ON	Marker
Search/Tracking: ON	Marker Search - Tracking (Turn it ON.)

Measurement Examples

Evaluating a Duplexer

Setup Description	Key Operation
Moving Marker 1 to the trace maximum	Max
Bandwidth search: ON	Bandwidth (Turn it ON)

In the example shown in Figure 15-15, the insertion loss (**loss**) is 1.627 dB and the 3-dB bandwidth (**BW**) is 71.04 MHz.

Step 3. Determine the isolation between Tx and Rx.

Setup Description	Key Operation
Activating Trace 3	Trace Next
Marker 1: ON	Marker
Search/Tracking: ON	Marker Search - Tracking (Turn it ON)
Moving Marker 1 to the peak near 1.92 GHz	Peak - Search Left or Search Right (press as many times as necessary)

In the example shown in Figure 15-15, isolation (response value of marker 1) is 6.612 dB.

Step 4. Determine the return loss of Tx.

Setup Description	Key Operation
Activating Trace 4	Trace Next
Marker 1: ON	Marker
Search/Tracking: ON	Marker Search - Tracking (Turn it ON)
Moving Marker 1 to the peak in the pass band	Peak - Search Left or Search Right (press as many times as necessary) ^{*1}

*1. If you cannot move the marker to the desired peak, use **Peak Excursion** to change the peak deviation and then execute the search again. (Example: **Peak Excursion** -

0 **.** **1** **x1**).

In the example of Figure 15-15, return loss (response value of Marker 1) is 12.65 dB.

Step 5. Determine the return loss of Rx.

Setup Description	Key Operation
Activating Trace 5	Trace Next
Marker 1: ON	Marker
Search/Tracking: ON	Marker Search - Tracking (Turn it ON)

Setup Description

Key Operation

Moving Marker 1 to the peak in the pass band

Peak - Search Left|Search Right (press as many times as necessary)*1

*1. If you cannot move the marker to the desired peak, use **Peak Excursion** to change the peak deviation and then execute the search again. (Example: **Peak Excursion -**

0 **.** **1** **x1**).

In the example of Figure 15-15, return loss (response value of Marker 1) is 13.80 dB.

Step 6. Turn on the marker table display.

Setup Description

Key Operation

Marker table display: ON

Marker Fctn - **Marker Table** (Turn it ON)

Figure 15-15

Analyzing duplexer parameters

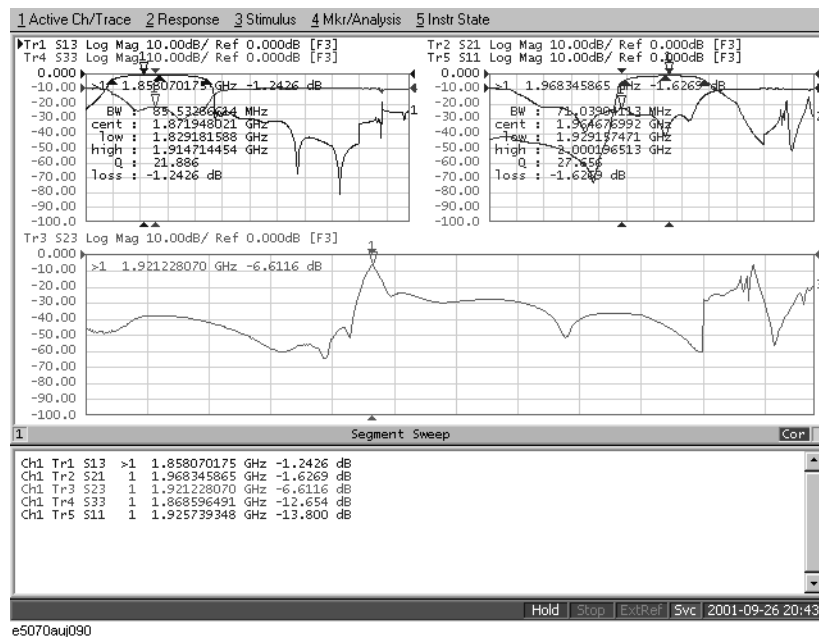

10. Define the Setup for a Limit Table

Follow the steps below to make entries in the limit table.

Step 1. Display the limit table for Trace 1 (S₁₃).

Setup Description

Key Operation

Activating Trace 1

Trace Next

Displaying a limit table

System - **Limit Test** - **Edit Limit Line**

Measurement Examples

Evaluating a Duplexer

Step 2. Enter the setup data in the limit table for trace 1 (Figure 15-16).

Figure 15-16

Completed limit table for trace 1

	Type	Begin Stimulus	End Stimulus	Begin Response	End Response
1	MAX	1.730000000 GHz	1.940000000 GHz	0 dB	0 dB
2	MIN	1.850000000 GHz	1.910000000 GHz	-4 dB	-4 dB
3	MAX	1.930000000 GHz	1.990000000 GHz	-40 dB	-40 dB
4	MAX	1.990000000 GHz	2.130000000 GHz	-40 dB	-40 dB
5	MAX	2.130000000 GHz	6.020000000 GHz	-25 dB	-25 dB
6					

e5070auj091

Step 3. Display the limit table for Trace 2 (S₂₁).

Setup Description

Key Operation

Activating Trace 2

Trace Next

Step 4. Enter the setup data in the limit table for trace 2 (Figure 15-17).

Figure 15-17

Completed limit table for trace 2

	Type	Begin Stimulus	End Stimulus	Begin Response	End Response
1	MAX	1.730000000 GHz	1.850000000 GHz	-40 dB	-40 dB
2	MAX	1.850000000 GHz	1.910000000 GHz	-45 dB	-45 dB
3	MAX	1.910000000 GHz	6.020000000 GHz	0 dB	0 dB
4	MIN	1.930000000 GHz	1.990000000 GHz	-5 dB	-5 dB
5					

e5070auj092

11. Execute the Limit Test

The limit test is executed.

Step 1. Turn on the limit line and limit test for Trace 1.

Setup Description

Key Operation

Activating Trace 1

Trace Prev

Limit Line: ON

System - **Limit Test - Limit Line** (Turn it **ON**)

Limit Test: ON

Limit Test (Turn it **ON**)

Step 2. Turn on the limit line and limit test for Trace 2.

Setup Description	Key Operation
Activating Trace 2	Trace Next
Limit Line: ON	Limit Line (Turn it ON)
Limit Test: ON	Limit Test (Turn it ON)

Step 3. Apply a trigger to execute the measurement.

Setup Description	Key Operation
Trigger Mode: Single	Trigger - Single (or Continuous)

Figure 15-18

Limit test results

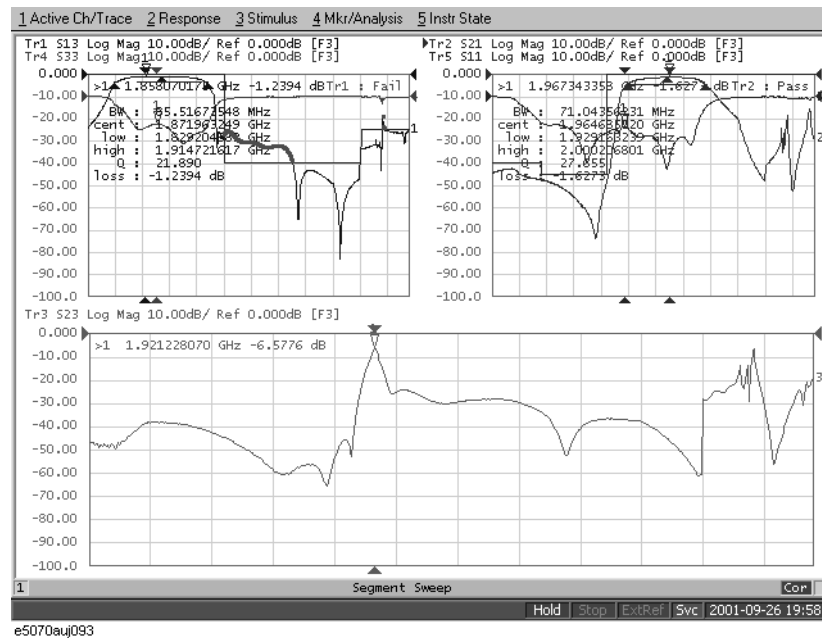

Step 4. Maximize the screen display of Trace 1 to examine its details.

Setup Description	Key Operation
Activating Trace 1	Trace Prev
Maximizing the display of Trace 1	Trace Max

Figure 15-19

Enlarged display of trace 1

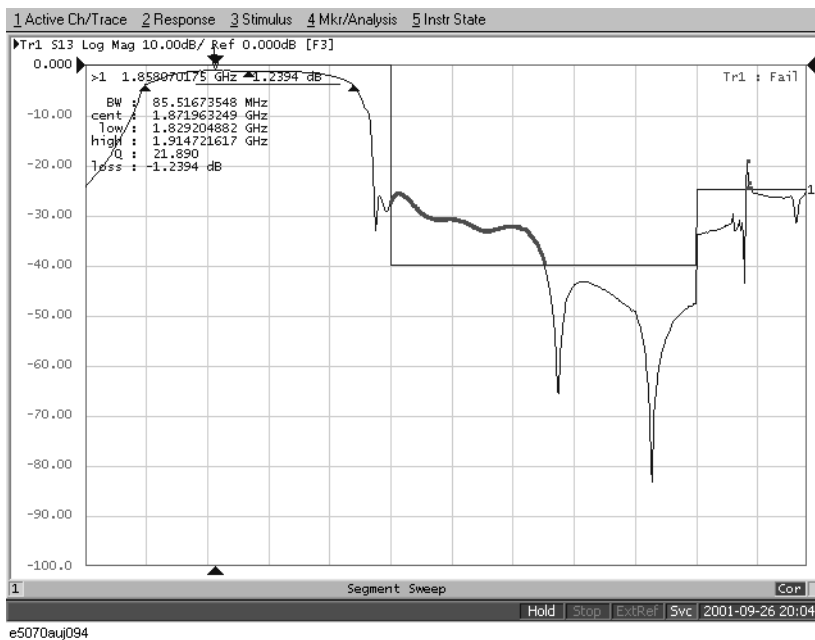

Step 5. Maximize the screen display of Trace 2 to examine its details.

Setup Description

Key Operation

Activating Trace 2

Trace Prev (The display of Trace 2 is maximized.)

Figure 15-20

Enlarged display of trace 2

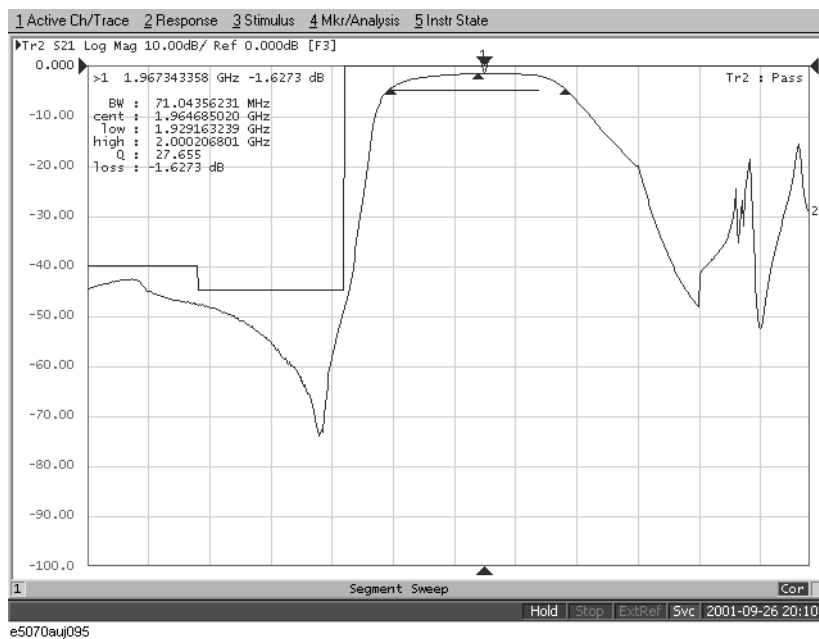

Measuring the Deviation from a Linear Phase

This section illustrates how to determine the deviation from a linear phase in the pass band of a 1.09-GHz bandpass filter.

Evaluation Steps

Here, the DUT is evaluated by following the steps described in Table 15-5.

Table 15-5 Evaluating the Deviation from a Linear Phase

Step	Description
“1. Connect the DUT” on page 505	The DUT is connected.
“2. Define the Measurement Conditions” on page 506	The measurement conditions are defined.
“3. Execute the Calibration” on page 506	The calibration is executed.
“4. Connect the DUT and Execute the Auto Scale” on page 506	The DUT is connected again to execute the auto scale function.
“5. Specify the Electrical Delay” on page 507	The electrical delay is specified.
“6. Measure the Deviation from a Linear Phase” on page 508	The statistics data function (peak-to-peak) is used to determine the deviation from a linear phase.

1. Connect the DUT

Connect the DUT as shown in Figure 15-21.

Figure 15-21 Connecting the DUT

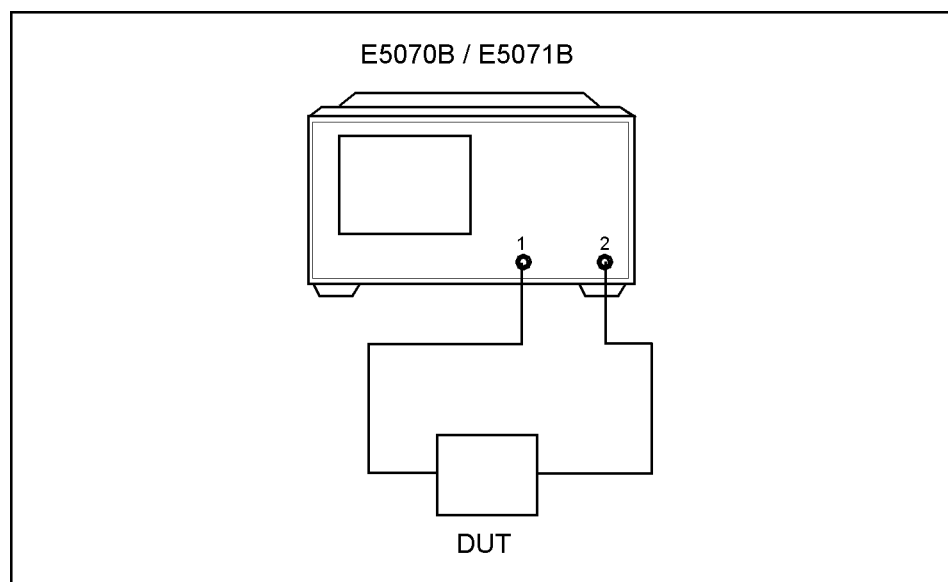

e5070bu025

2. Define the Measurement Conditions

The measurement conditions are defined by following the steps described below.

Setup Description	Key Operation
Presetting	Preset - OK
Center frequency: 1.09 GHz	Center 1 . 0 9 G/n
Frequency span: 20 MHz	Span 2 0 M/μ
Measurement parameter: S_{21}	Meas - S_{21}
Data format: Expand Phase	Format - Expand Phase
Executing the Auto Scale	Scale - Auto Scale

3. Execute the Calibration

The THRU response calibration is executed.

Setup Description	Key Operation
Executing the THRU response	(A THRU standard is connected instead of a DUT) Cal - Calibrate - Response (Thru) - Thru - Done

4. Connect the DUT and Execute the Auto Scale

The DUT is connected again as shown in Figure 15-21 to execute the auto scale.

Setup Description	Key Operation
Executing the auto scale	Scale - Auto Scale

Figure 15-22

Phase characteristics of the DUT

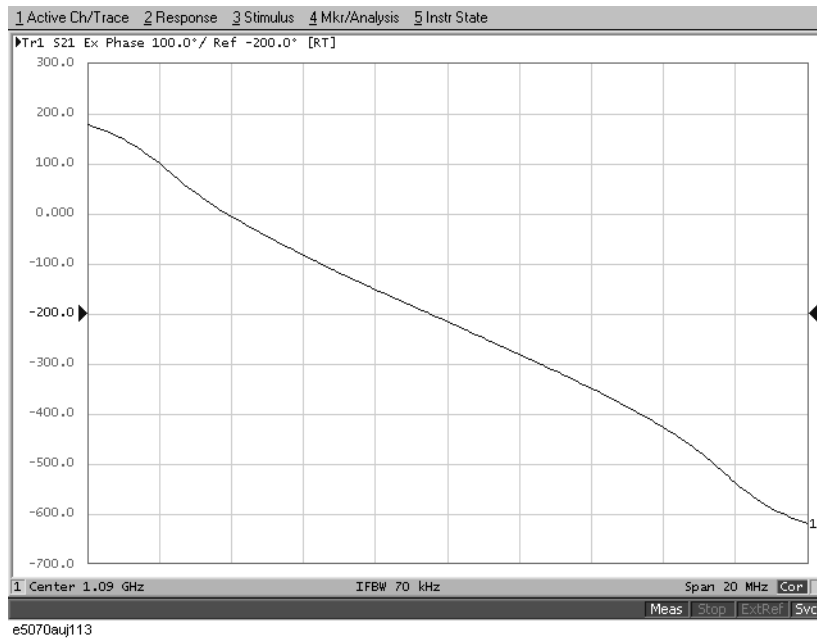

5. Specify the Electrical Delay

The electrical delay is entered to flatten the phase trace.

Setup Description

Key Operation

Entering the electrical delay

Scale - Electrical Delay - (Flattening a trace)

Figure 15-23

Entering the electrical delay

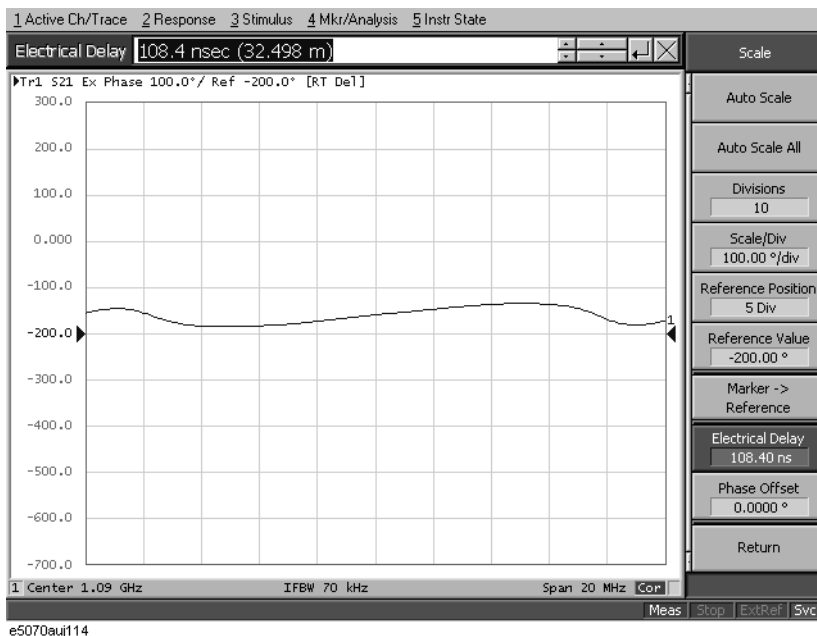

6. Measure the Deviation from a Linear Phase

The statistics data is used to read the deviation from a linear phase (peak-to-peak) (Figure 15-24).

Setup Description	Key Operation
Executing the auto scale	Scale - Auto Scale
Displaying the statistics data	Marker Fctn - Statistics (Turn it ON .)

Figure 15-24

Measuring the deviation from a linear phase

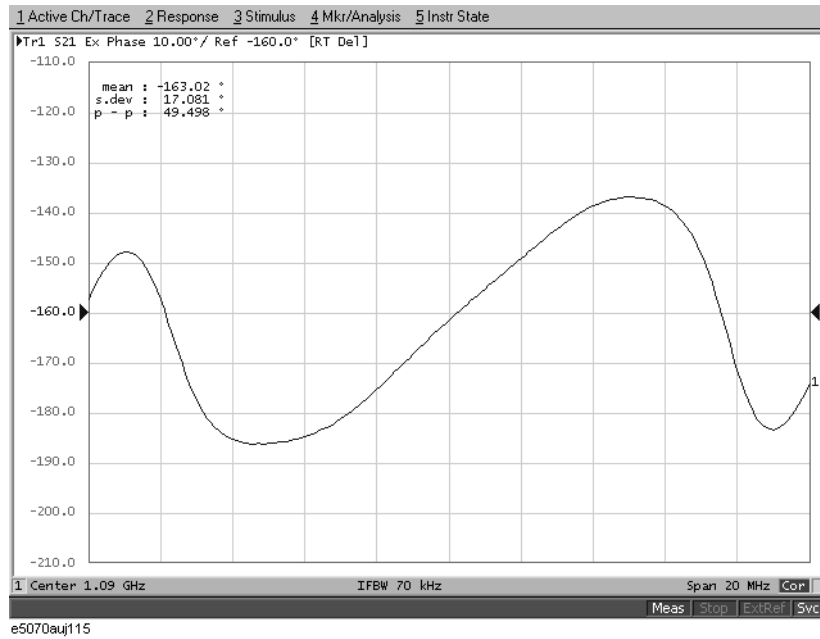

Measuring an Unbalanced and Balanced Bandpass Filter

This section introduces an example of actually evaluating the unbalanced and balanced SAW bandpass filter with a center frequency of 942.5 MHz. Figure 15-25 shows the measurement circuit in the condition for evaluating a DUT.

Figure 15-25 Measurement circuit

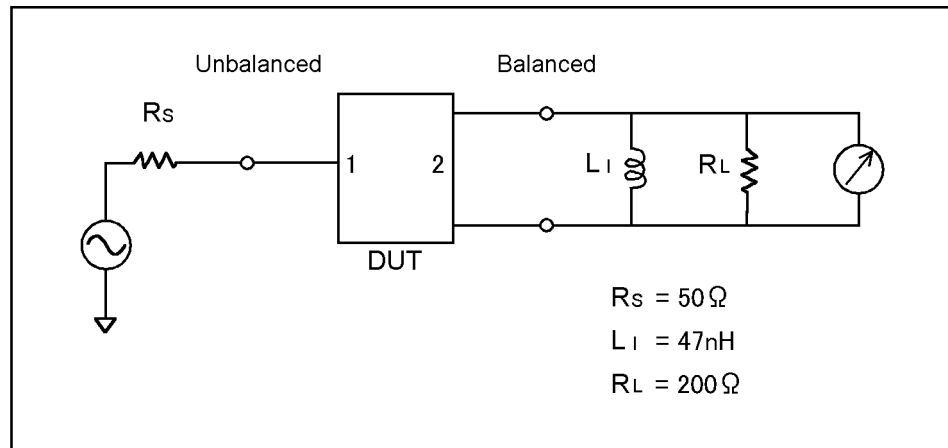

Evaluation Steps

Here, the DUT is evaluated by following the steps described in Table 15-6.

Table 15-6 Evaluating the Deviation from a Linear Phase

Step	Description
“1. Connecting the DUT” on page 510	The DUT is connected.
“2. Setting the Measurement Conditions” on page 511	The measurement conditions are defined.
“3. Performing Calibration” on page 512	The full 3-port calibration is executed.
“4. Setting a Balance Conversion Topology” on page 513	The balance conversion topology is specified.
“5. Selecting Measurement Parameters” on page 513	The mixed-mode S-parameters are selected.
“6. Extending the Calibration Plane (removing the cause of error)” on page 515	The calibration reference plane is extended.
“7. Setting the Port Reference Impedances” on page 515	The port reference impedances are specified.
“8. Adding a Matching Circuit” on page 517	A matching circuit is added.

1. Connecting the DUT

Connect the DUT to the E5070B/E5071B by using the instrument's three test ports (Figure 15-26).

Figure 15-26

Connecting the DUT

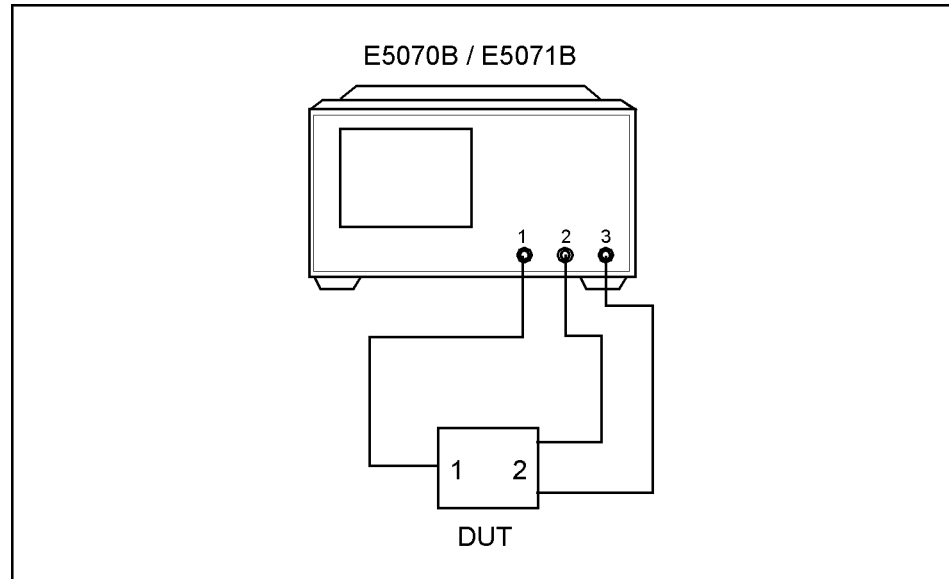

e5070buj026

2. Setting the Measurement Conditions

Follow the procedure below to set the measurement conditions. The measurement parameters for balanced measurements should be set after unbalanced-to-balanced conversion. Here, set the measurement parameters for observing the characteristics achieved during unbalanced measurements.

Setting Description	Key Operation
Preset for setting	Preset - OK
Center frequency: 940 MHz	Center 9 4 0 M/μ
Frequency span: 200 MHz	Span 2 0 0 M/μ
Number of traces: 2	Display - Num of Traces - 2
Trace-1 measurement parameter: S_{21}	Meas - S21
Trace-2 measurement parameter: S_{31}	Trace Next Meas - S31
Allocate a trace to upper and lower displays	Display - Allocate Traces - <input type="text" value="x 2"/>
Auto-scale all traces	Scale - Auto Scale All

Figure 15-27

Results of unbalanced measurements

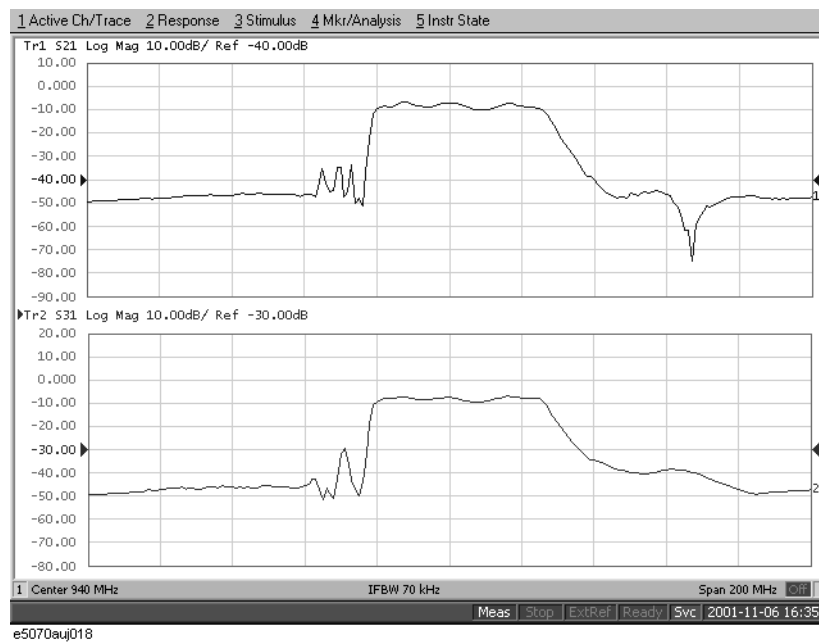

3. Performing Calibration

Perform a full three-port calibration for the three ports to be used.

Step 1. Set the type and conditions of calibration.

Setting Description	Key Operation
Calibration kit to use: 85033D	<input type="button" value="Cal"/> - Cal Kit - 85033D
Type of calibration: Full three-port calibration	Calibrate - 3-Port Cal
Test ports to calibrate: 1, 2, 3	Select Ports - 1-2-3 (check only)

Step 2. Perform a reflection calibration.

Setting Description	Key Operation
Select reflection calibration	Reflection
Perform Port 1 calibration	(With the OPEN connected) Port 1 OPEN (With the SHORT connected) Port 1 SHORT (With the LOAD connected) Port 1 LOAD
Perform Port 2 calibration	(With the OPEN connected) Port 2 OPEN (With the SHORT connected) Port 2 SHORT (With the LOAD connected) Port 2 LOAD
Perform Port 3 calibration	(With the OPEN connected) Port 3 OPEN (With the SHORT connected) Port 3 SHORT (With the LOAD connected) Port 3 LOAD

Step 3. Perform a transmission calibration.

Setting Description	Key Operation
Select transmission calibration	Return - Reflection
Perform a Port 1-to-Port 2 calibration	(With thru connection) Port 1-2 Thru
Perform a Port 1-to-Port 3 calibration	(With thru connection) Port 1-3 Thru
Perform a Port 2-to-Port 3 calibration	(With thru connection) Port 2-3 Thru

Step 4. Finish the calibration.

Setting Description	Key Operation
Complete the calibration and then calculate and store calibration coefficients.	Return - Done (This causes Correction to turn ON .)
Calibration property display: ON	Return - Return - Property (Turns it ON .)

4. Setting a Balance Conversion Topology

Follow the procedure below to set the balanced conversion topology.

Table 15-7

Setting Description	Key Operation
Set port 1 on the DUT to unbalanced and port 2 on the DUT to balanced.	Analysis - Fixture Simulator - Topology - Device - SE-Bal (check only)
Set the connecting destination of port 1 on the DUT (unbalanced) to test port 1 of the analyzer.	Port 1 (se) - 1 (check only)
Set the connecting destination of port 2 on the DUT (balanced) to test ports 2 and 3 of the analyzer.	Port 2 (bal) - 2-3 (check only)

5. Selecting Measurement Parameters

Step 1. Display four traces.

Setting Description	Key Operation
Number of traces: 4	Display - Number of Traces - 4
Trace allocation: 4-part split	Allocate Traces - <input type="text" value="x 4"/>

Step 2. Set the measurement parameter (mixed mode S-parameter) and data format for trace 1.

Setting Description	Key Operation
Fixture simulator: ON	Analysis - Fixture Simulator - Fixture Simulator (turns it ON)
Unbalanced-balanced conversion of trace 1: ON	BalUn (turns it ON)
Measurement parameter: S_{ds21}	Meas - Sds21

Step 3. Set the measurement parameter (mixed mode S-parameter) and data format for trace 2.

Setting Description	Key Operation
Unbalanced-balanced conversion of trace 2: ON	Trace Next - Analysis - Fixture Simulator - BalUn (turns it ON)
Measurement parameter: S_{cs21}	Meas - Scs21

Measurement Examples

Measuring an Unbalanced and Balanced Bandpass Filter

Step 4. Set the measurement parameter (mixed mode S-parameter) and data format for trace 3.

Setting Description	Key Operation
Unbalanced-balanced conversion of trace 3: ON	Trace Next - Analysis - Fixture Simulator - BalUn (turns it ON)
Measurement parameter: S_{ss11}	Meas - Sss11
Data format: Smith chart (marker display: $R+jX$)	Format - Smith - R + jX

Step 5. Set the measurement parameter (mixed mode S-parameter) and data format for trace 4.

Setting Description	Key Operation
Unbalanced-balanced conversion of trace 4: ON	Trace Next - Analysis - Fixture Simulator - BalUn (turns it ON)
Measurement parameter: S_{dd22}	Meas - Sdd22
Data format: Smith chart (marker display: $R+jX$)	Format - Smith - R + jX

Figure 15-28 shows the setting results for each parameter.

Figure 15-28

Measurement results after unbalanced-balanced conversion

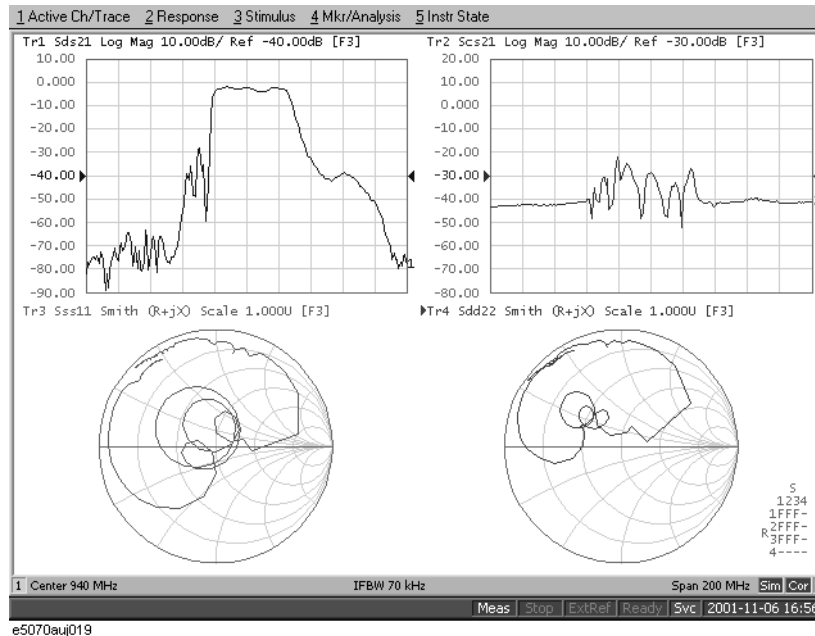

6. Extending the Calibration Plane (removing the cause of error)

In this section you will use the port extension function to remove an electrical delay caused by cables or fixtures located between the calibration reference plane and the DUT to be evaluated. If you can provide a two-port Touchstone data file representing the characteristics of the network to be removed, the network removal function allows you to remove the network and extend the calibration reference plane.

Follow the procedure below to set port extension for each test port.

Setting Description	Key Operation
Port extension of test port 1: 260 ps	Cal - Port Extensions - Extension Port 1 - 2 6 G/n
Port extension of test port 2: 260 ps	Extension Port 2 - 2 6 G/n
Port extension of test port 3: 260 ps	Extension Port 3 - 2 6 G/n
Port extension: ON	Extensions (turns it ON)

Figure 15-29 shows the results of extending the calibration reference plane.

Figure 15-29

Results of extending the calibration reference plane

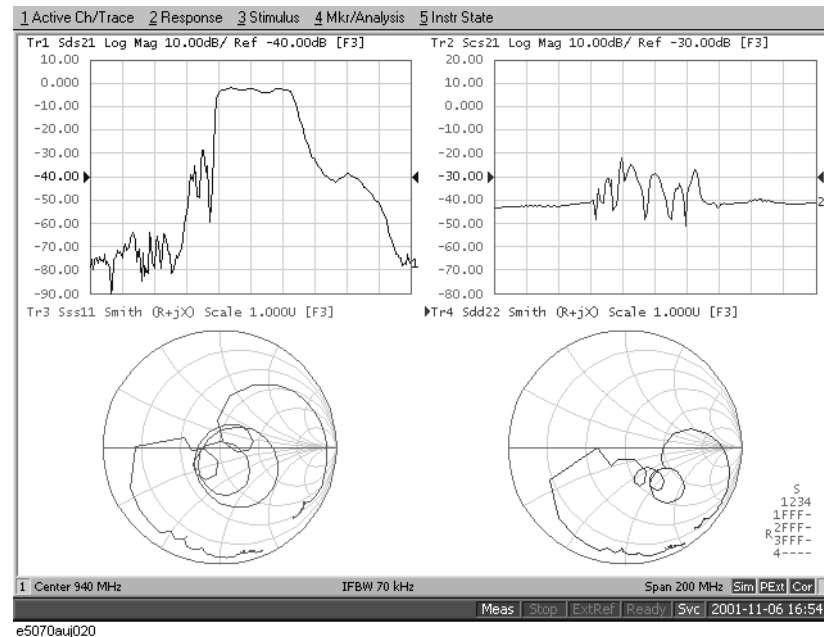

7. Setting the Port Reference Impedances

With the reference impedances of two test ports in unbalanced measurements set to Z_0 , conversion of those ports into balanced ports permits the impedance of the balanced ports' common mode to be automatically set to $Z_{0/2}$ and the impedance of their differential mode to be automatically set to $2Z_0$.

Measuring an Unbalanced and Balanced Bandpass Filter

Step 1. Set the port reference impedance of port 1 on the DUT (unbalanced) to 50 Ω.

Setting Description	Key Operation
Reference impedance of test port 1: 50 Ω	Analysis - Fixture Simulator - Port Z conversion - Port 1 Z0 - <input type="text" value="5"/> <input type="text" value="0"/> <input type="text" value="x1"/>

Step 2. In order to set the impedance of the differential mode of port 2 on the DUT (balanced) to 200 Ω, set the impedances of two unbalanced ports before conversion each to 100 Ω.

Setting Description	Key Operation
Reference impedance of test port 2: 100 Ω	Port 2 Z0 - <input type="text" value="1"/> <input type="text" value="0"/> <input type="text" value="0"/> <input type="text" value="x1"/>
Reference impedance of test port 3: 100 Ω	Port 3 Z0 - <input type="text" value="1"/> <input type="text" value="0"/> <input type="text" value="0"/> <input type="text" value="x1"/>

NOTE

Always set the reference impedances of the two test ports before balanced conversion to the same value.

Step 3. Turn on the port reference impedance conversion function.

Setting Description	Key Operation
Port reference impedance conversion: ON	Port Z Conversion (turns it ON)

The reference impedance of the command mode of port 2 on the DUT is set to 50 Ω. The impedance of the differential mode of that port may be set and modified independently of setting the two-port reference impedances before balanced conversion. For more information, see “Converting Reference Impedance of Balanced Port” on page 300.

Figure 15-30 shows the results of port reference impedance conversion.

Figure 15-30

Results of port reference impedance conversion

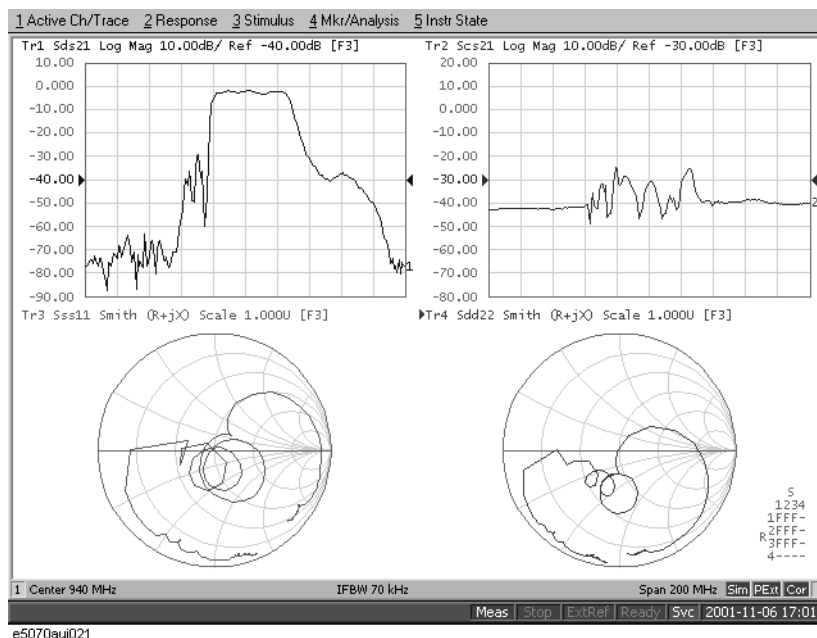

8. Adding a Matching Circuit

Here, add an inductance of 47 nH in parallel to port 2 on the DUT (balanced). It is also possible to add a matching circuit to the port before unbalanced-balanced conversion. For more information, see “Determining the Characteristics that Result from Adding a Matching Circuit to a Differential Port” on page 303.

Setting Description	Key Operation
Selecting a matching circuit: Shunt L - Shunt C	Return (or Analysis) - Fixture Simulator - Diff. Matching - Select Circuit - Shunt L-Shunt C
Inductance: 47 nH	L - <input type="text" value="4"/> <input type="text" value="7"/> <input type="text" value="G/n"/>
C=0, G=0, R=0	(checks that C , G , and R have been set to 0 .)
Differential matching circuit function: ON	Diff. Matching (turns it ON)

Figure 15-31 shows the results of adding a matching circuit.

Figure 15-31

Results of adding a matching circuit (47 nH)

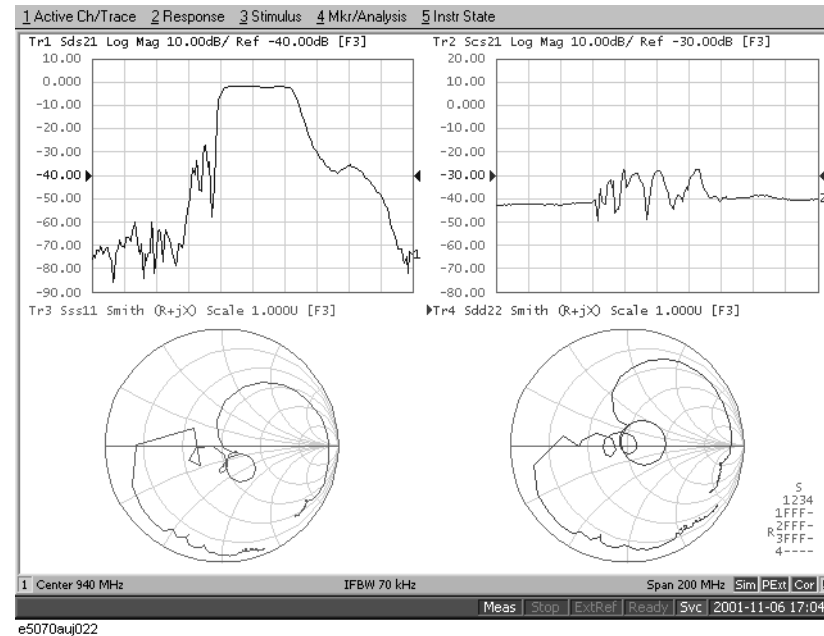

Measuring Parameters with Cable

This section introduces an example of how to detect the location of a mismatch that occurs in a cable by using the time domain function.

Overview of evaluation procedure

In this example, a DUT is evaluated according to the steps shown in Table 15-8.

Table 15-8 Evaluation Procedure for Deviation from Linear Phase

Step	Description
“1. Setting the Measurement Conditions” on page 518	Set the measurement conditions.
“2. Executing Calibration” on page 518	Execute calibration.
“3. Connecting the DUT” on page 519	Connect the DUT.
“4. Auto Scale” on page 519	Execute auto scale.
“5. Setting the Time Domain Function” on page 520	Set the time domain function.

1. Setting the Measurement Conditions

Follow these steps to set the measurement conditions:

Setting Description	Key Operation
Presetting	Preset - OK
Stop frequency: 3 GHz	Start 3 G/n
Number of points: 201	Sweep Setup - Points - 2 0 1 x1
Specifying the low-pass mode sweep condition	Analysis - Transform - Set Freq Low Pass
Measurement parameter: S11	Meas - S11

2. Executing Calibration

By following “1-Port Calibration (reflection test)” on page 113, execute 1-port calibration on port 1.

3. Connecting the DUT

Connect the DUT as shown in Figure 15-32.

Figure 15-32

Connecting the DUT

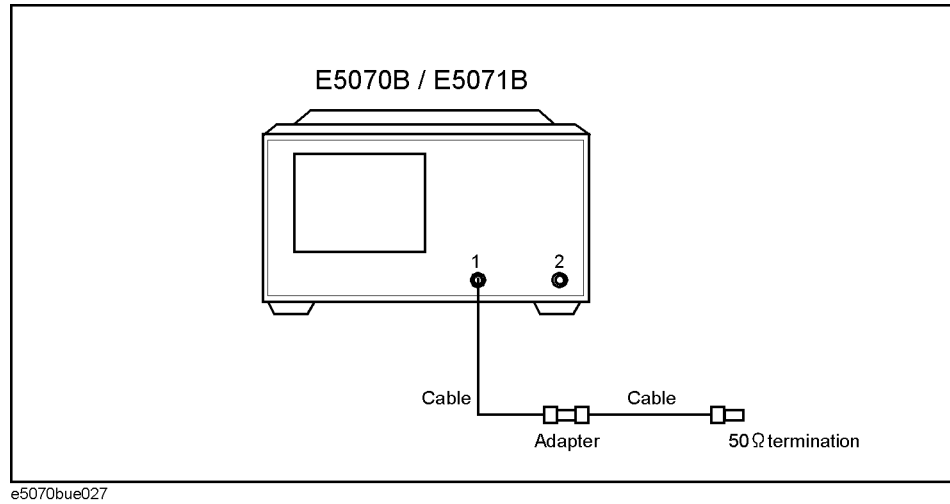

e5070bue027

4. Auto Scale

Execute the auto scale function.

Setting Description

Key Operation

Executing auto scale

Scale - Auto Scale

Figure 15-33

Response in frequency domain

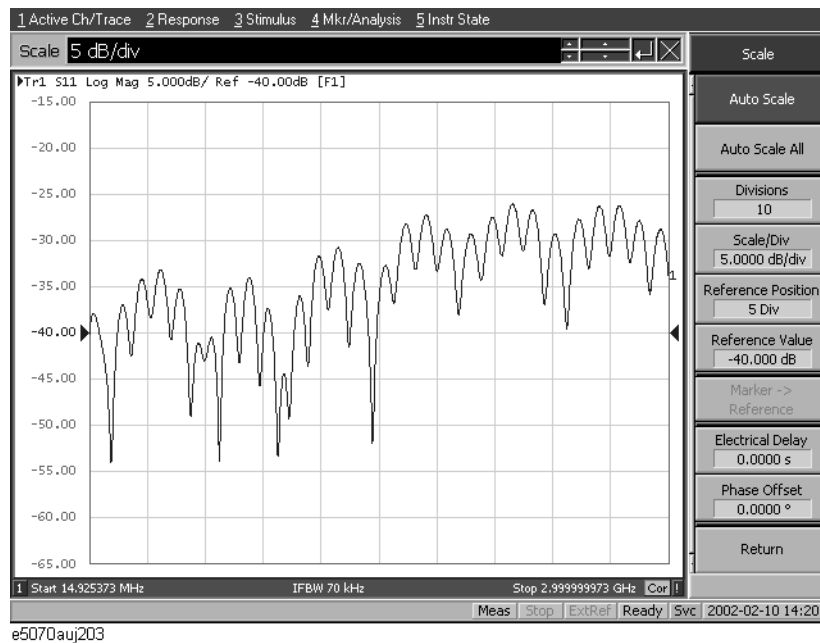

e5070auj203

5. Setting the Time Domain Function

Set the conversion function to display the response in time the domain. If you enable this setting, the response in time domain is displayed as shown in Figure 15-34. A peak indicating a small mismatch appears at the location of the connector.

Setting Description	Key Operation
Data format: real	Format - Real
Setting the transformation type to low-pass impulse	Analysis - Transform - Lowpass Imp.
Setting the window type to maximum.	Window - Maximum
Setting the display range: from 0 s to 10 ns	Start - 0 x1 Stop - 2 0 G/n
Enabling the transformation function	Transform (set to ON)
Executing auto scale	Scale - Auto Scale

Figure 15-34

Response in time domain

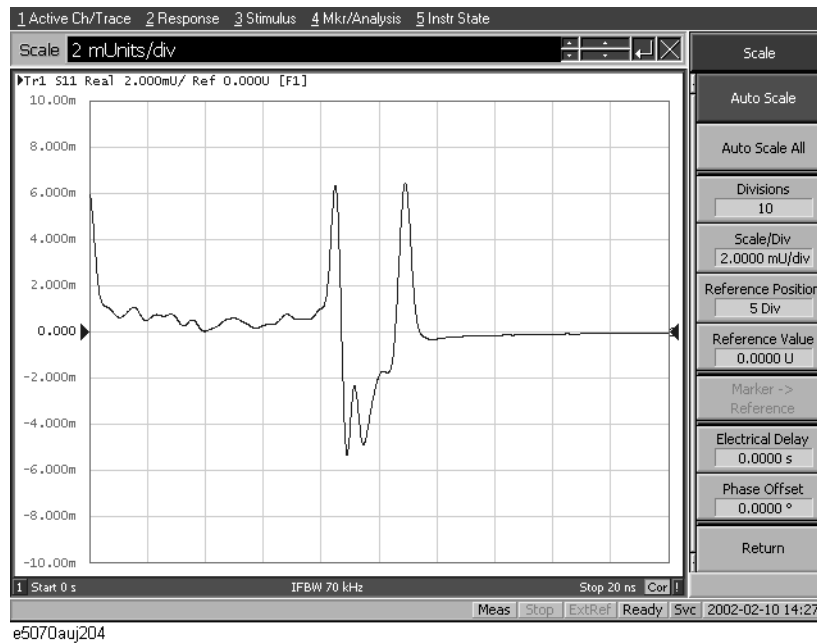

Evaluating Transmission Characteristics of a Front End Module

This example shows how to measure the transmission characteristics of a 6-port front end module, as shown in Figure 15-35, by using the E5070B/E5071B and the E5091A.

Figure 15-35 Front end module

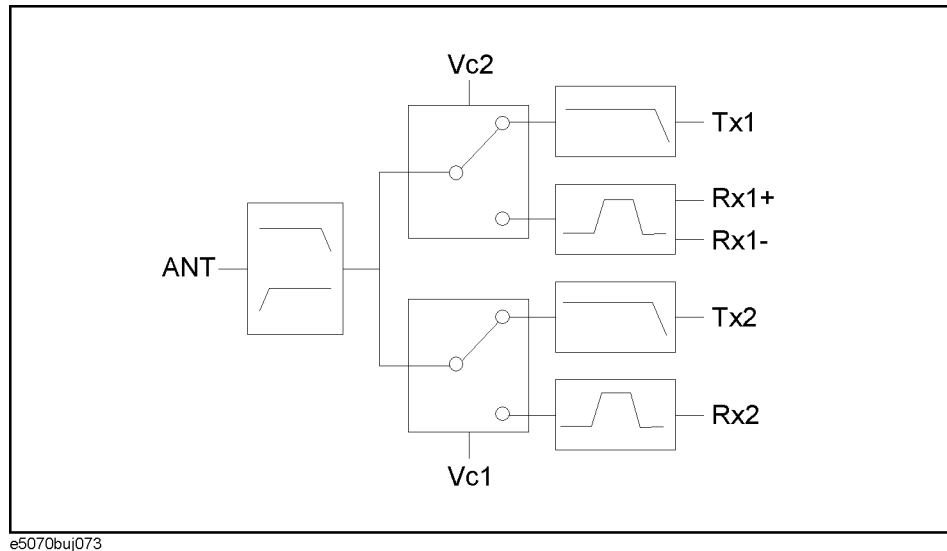

Overview of evaluation procedure

In this example, a DUT is evaluated according to the procedure shown in Table 15-9.

Table 15-9 Evaluation Procedure for 6-port Front End Module

Procedure	Description
“1. Determining Measurement Conditions” on page 522	Determine the measurement conditions such as the sweep conditions and measurement ports.
“2. Setting Channel Window Allocation” on page 522	Set the allocation of the channel windows on the screen.
“3. Setting the Test Ports” on page 522	Determine the test port assignment for each channel.
“4. Setting Control Line” on page 523	Set the E5091A's control line.
“5. Setting Sweep Conditions” on page 523	Set the sweep range and the number of points.
“6. Setting Balance Conversion Topology” on page 523	Set the balance port and unbalance port assignment.
“7. Selecting Measurement Parameter” on page 524	Set the measurement parameter.
“8. Executing Calibration” on page 524	Perform calibration using 4-port ECal.
“9. Connecting DUT” on page 526	Connect the DUT.

Table 15-9 Evaluation Procedure for 6-port Front End Module

Procedure	Description
“10. Executing Measurement” on page 527	Execute the measurement and perform auto scale.

1. Determining Measurement Conditions



In this example, perform measurement under the measurement conditions in Table 15-9.

Table 15-10 Sweep conditions

Channel	Start frequency	Stop frequency	NOP	Test port assignment	Control line	Meas. parameter	Calibration	
							Type	Port
1	400 MHz	1.4 GHz	201	Port 1 - Port A Port 2 - Port T1	Line 1: Low Line 2: High	S12	Full 2-Port	1,2
2	880 MHz	1 GHz	101	Port 3 - Port R1+ Port 4 - Port R1-	Line 1: Low Line 2: Low	Sds21	Full 3-Port	1,3,4
3	1.34 GHz	2.34 GHz	201	Port 1 - Port A Port 2 - Port T2	Line 1: High Line 2: Low	S12	Full 2-Port	1,2
4	1.665 GHz	2.015 GHz	101	Port 3 - Port R2+ Port 4 - Port R1-	Line 1: Low Line 2: Low	S31	Full 2-Port	1,3

2. Setting Channel Window Allocation

Set the screen to split into 2 rows and 2 columns to assign channel windows after preset.

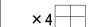
Setting Description	Key Operation
Execute preset	 - OK
Allocate channel windows	 - Allocate Channels - 

3. Setting the Test Ports

Step 1. Display the E5091A setup menu and select the 9-port model for ID1.

Setting Description	Key Operation
Display the E5091A setup menu	 - Multiport Test Set Setup
Select the 9-port model for ID1	Test Set 1 - Select Test Set - E5091_9

Step 2. Display the E5091A properties.

Setting Description	Key Operation
Display the E5091A properties	Property

Step 3. Select the test ports assigned to ports 1 to 4 for channel 1.

Setting Description	Key Operation
Assign test port A to port 1.	Port1 - A
Assign test port T1 to port 2.	Port2 - T1
Assign test port R1+ to port 3.	Port3 - R1+
Assign test port R1- to port 4.	Port4 - R1-

Step 4. Assign test ports for channels 2, 3, and 4. Press the Channel Next key to switch the active channel and then make the setting in the same way as Step 3.

Step 5. Enable the control of the E5091A.

Setting Description	Key Operation
Enable the control of the E5091A.	Control (set it to ON)

4. Setting Control Line

Step 1. Set the bits of the control line for channel 1.

Setting Description	Key Operation
Set channel 1 to the active channel.	Channel Next
Line 1: Low	Control Lines (check only)
Line 2: High	Control Lines - Line 1 (set it to High)

Step 2. Set the control line for channels 2, 3, and 4 according to the same procedure as in Step 1.

5. Setting Sweep Conditions

Step 1. Set the sweep conditions for channel 1.

Setting Description	Key Operation
Set channel 1 to the active channel.	Channel Next
Start frequency: 400 MHz	Start 4 0 0 M/μ
Stop frequency: 1.4 GHz	Stop 1 . 4 G/n
Number of points: 201	Sweep Setup - Point - 2 0 1 x1

Step 2. Set sweep conditions for channels 2, 3, and 4 according to the same procedure as in Step 1.

6. Setting Balance Conversion Topology

For channel 2, set the balance conversion topology in order to perform measurement that

Measurement Examples

Evaluating Transmission Characteristics of a Front End Module

includes the balanced port.

Setting Description	Key Operation
Set channel 2 to the active channel.	Channel Next (press it until channel 2 is activated)
Set DUT port 1 to unbalance and DUT port 2 to balance.	Analysis - Fixture Simulator - Topology - Device - SE-Bal
Set the destination to which DUT port 1 (unbalance) is connected to test port 1 of the analyzer.	Port 1 (se) - 1
Set the destination to which DUT port 2 (balance) is connected to test ports 3 and 4 of the analyzer.	Port 2 (bal) - 3-4
Unbalance-balance conversion for trace 1: ON	BalUn (set it to ON)
Fixture simulator: ON	Fixture Simulator (set it to ON)

7. Selecting Measurement Parameter

Set the measurement parameter for channel 1.

Step 1. Select the measurement parameter for trace 1 of channel 1.

Setting Description	Key Operation
Set channel 1 to the active channel.	Channel Next (press it until channel 1 is activated)
Measurement parameter for trace 1: S12	Meas - S12

NOTE

The subscript of the measurement parameter means the test port of the E5070B/E5071B. Check the test port assignment and select the measurement parameter.

Step 2. Set measurement parameter for channels 2, 3, and 4 according to the same procedure as in Step 1.

8. Executing Calibration

Step 1. Display the Ecal menu.

Setting Description	Key Operation
Display the ECal menu.	Cal - ECal

Step 2. Set channel 1 to the active channel.

Setting Description	Key Operation
Switch the active channel.	Channel Next

Step 3. Check the test ports assigned to ports 1 to 4 in the E5091A properties and connect the 4-port ECal module to those ports.

Figure 15-36 Connecting the 4-port ECal

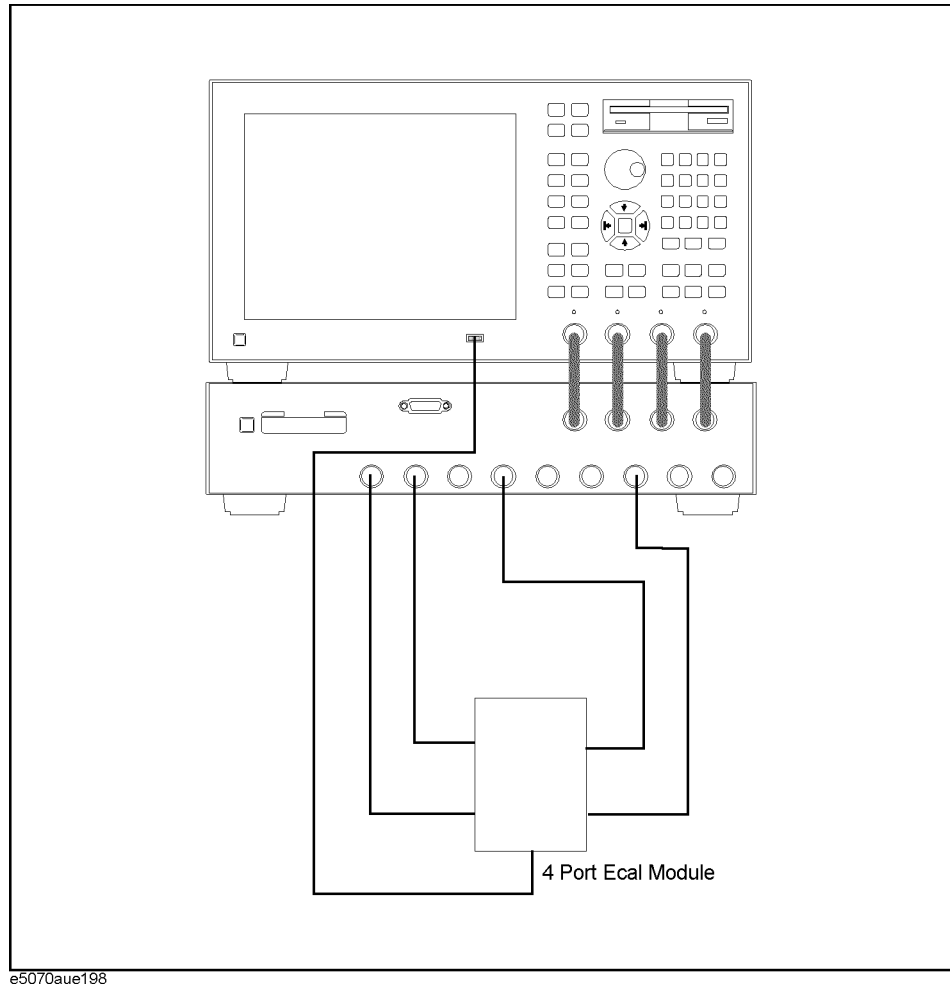

Step 4. Execute the calibration.

Setting Description	Key Operation
Select full 2-port calibration.	2-Port ECal
Select the port and execute the calibration.	1-2

Step 5. Perform calibration for channels 2, 3, and 4 according to the same procedure as in Step 2 to Step 4.

NOTE

Because the test port assignment setting for channels 1 and 2 and that for channels 3 and 4 are the same, you need not change the ECal connection.

9. Connecting DUT

Connect the DUT as shown in Figure 15-37.

Figure 15-37

Connecting 6-port front end module

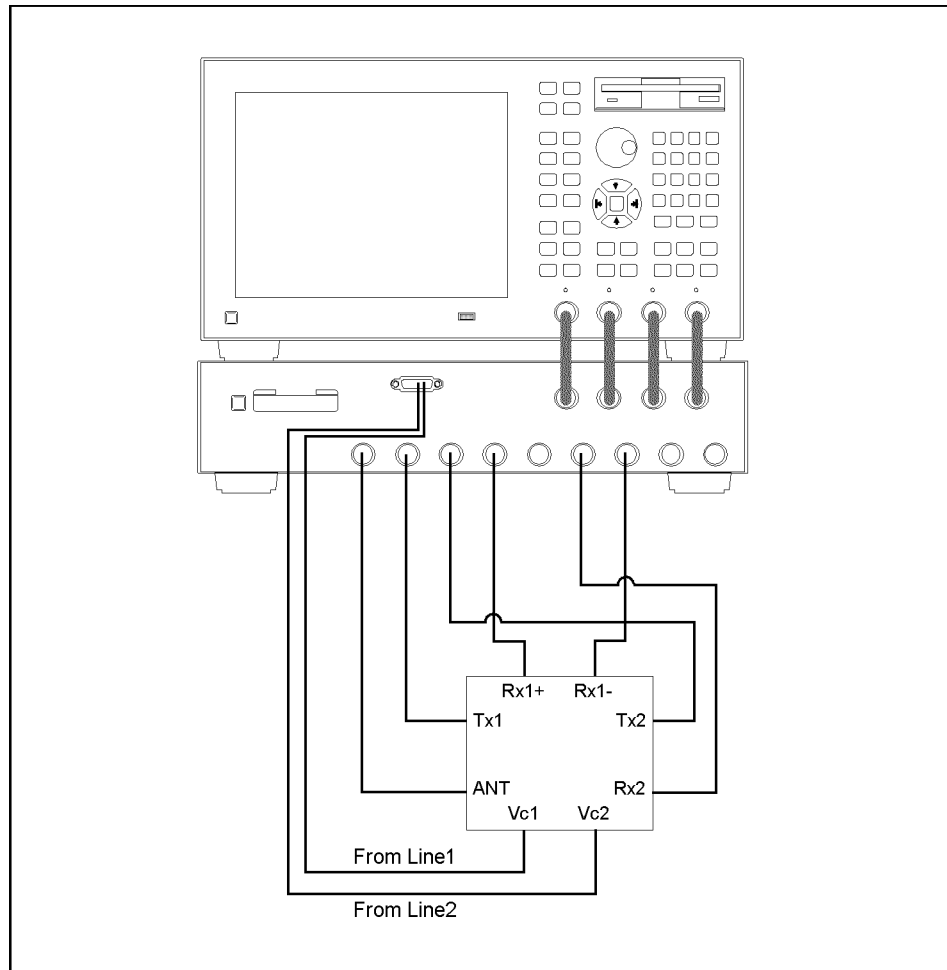

e5070aue197

10. Executing Measurement

Step 1. Display the trigger menu.

Description	Key Operation
Display the trigger menu.	Trigger

Step 2. Set the trigger source to “manual.”

Setting Description	Key Operation
Set the trigger source to “manual.”	Trigger Source - Manual

Step 3. Set the trigger mode for channel 1 to “continuous.”

Setting Description	Key Operation
Set channel 1 to the active channel.	Channel Next
Set the trigger mode to “continuous.”	Continuous

Step 4. Set the trigger mode for channels 2, 3, and 4 to “continuous” according to the same procedure as in Step 3.

Step 5. Execute the measurement.

Setting Description	Key Operation
Generate a trigger event.	Trigger

Step 6. Repeat the following procedure to execute auto scale for all of the channels.

Setting Description	Key Operation
Set the active channel.	Channel Next
Execute auto scale.	Scale - Auto Scale

Step 7. After all of the procedures are completed, the screen shown in Figure 15-38 appears.

Measurement Examples
Evaluating Transmission Characteristics of a Front End Module

Figure 15-38

Example of measuring a front end module

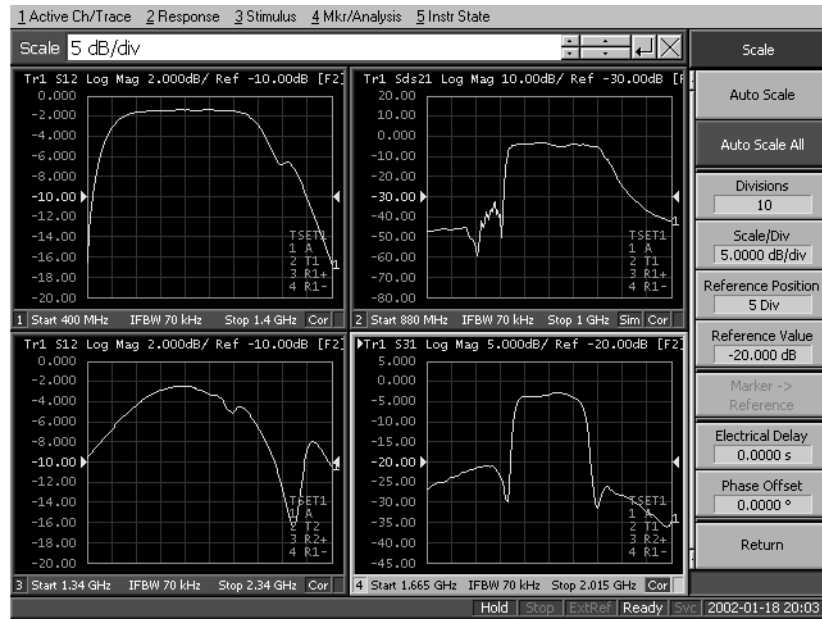

e5070auj201

Executing Power Calibration

This section shows an example of executing power calibration using the E4418B power meter and the E4412A power sensor.

Overview of execution procedure

In this example, power calibration is executed according to the steps shown in Table 15-11.

Table 15-11 Execution Procedure of Power Calibration

Step	Description
“1. Connecting Power Meter” on page 529	Connects the power meter to the E5070B/E5071B.
“2. Setting Address of Power Meter” on page 530	Configures the power meter's GPIB address with the E5070B/E5071B.
“3. Setting Stimulus Condition” on page 530	Sets conditions such as the power level and frequency.
“4. Executing Zero Adjustment and Calibration of Power Sensor” on page 530	Executes zero adjustment and calibration of the power sensor.
“5. Setting Calibration Data Measurement Conditions” on page 530	Selects the port, selects the power sensor, sets the number of measurements at one point, and sets the tolerance during power calibration.
“6. Connecting Power Sensor” on page 531	Connects the power sensor.
“7. Measuring Calibration Data” on page 531	Executes the measurement of calibration data.

1. Connecting Power Meter

Connect the E4418B (GPIB address: 14) to the E5070B/E5071B as shown in Figure 15-39.

Figure 15-39 Connecting power meter

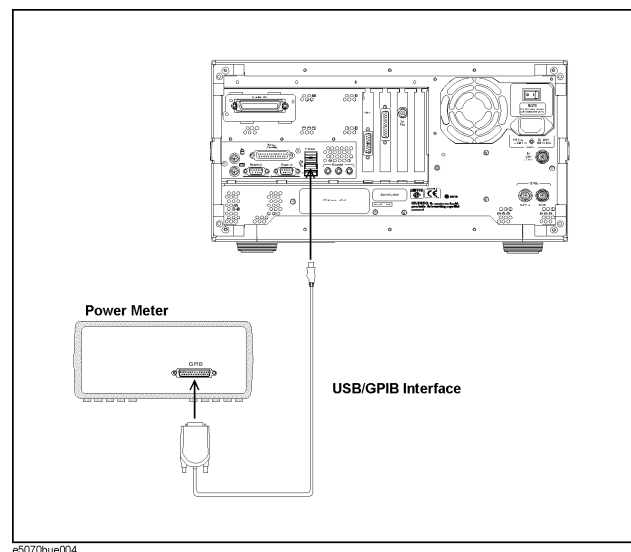

2. Setting Address of Power Meter

Follow these steps to configure the power meter's GPIB address.

Setting Description	Key Operation
GPIB address of the power meter: 14	System - Misc Setup - GPIB Setup - Power Meter Address - <input type="text" value="1"/> <input type="text" value="4"/> <input type="text" value="x1"/>

3. Setting Stimulus Condition

Follow these steps to configure the stimulus conditions:

Setting Description	Key Operation
Presetting	Preset - OK
Sweep type: Power	Sweep Setup - Sweep Type - Power Sweep
Fixed frequency: 1 GHz	Sweep Setup - Power - CW Freq - <input type="text" value="1"/> <input type="text" value="G/n"/>
Power range: -40 dBm to -8 dBm	Sweep Setup - Power - Power Ranges - -40 to -8
Start value: -40 dBm	Start <input type="text" value="+/-"/> <input type="text" value="4"/> <input type="text" value="0"/> <input type="text" value="x1"/>
Stop value: -10 dBm	Stop <input type="text" value="+/-"/> <input type="text" value="1"/> <input type="text" value="0"/> <input type="text" value="x1"/>
Number of points: 61	Sweep Setup - Points - <input type="text" value="6"/> <input type="text" value="1"/> <input type="text" value="x1"/>

4. Executing Zero Adjustment and Calibration of Power Sensor

Execute the zero adjustment and calibration of the power sensor according to the *E4418B Power Meter User's Guide*.

5. Setting Calibration Data Measurement Conditions

Follow these steps to set the calibration data measurement conditions:

Setting Description	Key Operation
Selecting the test port: 1	Cal - Power Calibration - Select Port - 1
Selection of power sensor: A	Cal - Power Calibration - Use Sensor [A]
Number of measurements at one measurement point: 4	Cal - Power Calibration - Num of Readings - <input type="text" value="4"/> <input type="text" value="x1"/>
Tolerance during power calibration: 5 dB	Cal - Power Calibration - Tolerance - <input type="text" value="5"/> <input type="text" value="x1"/>

6. Connecting Power Sensor

Connect the power sensor as shown in Figure 15-40.

Figure 15-40

Connecting power sensor

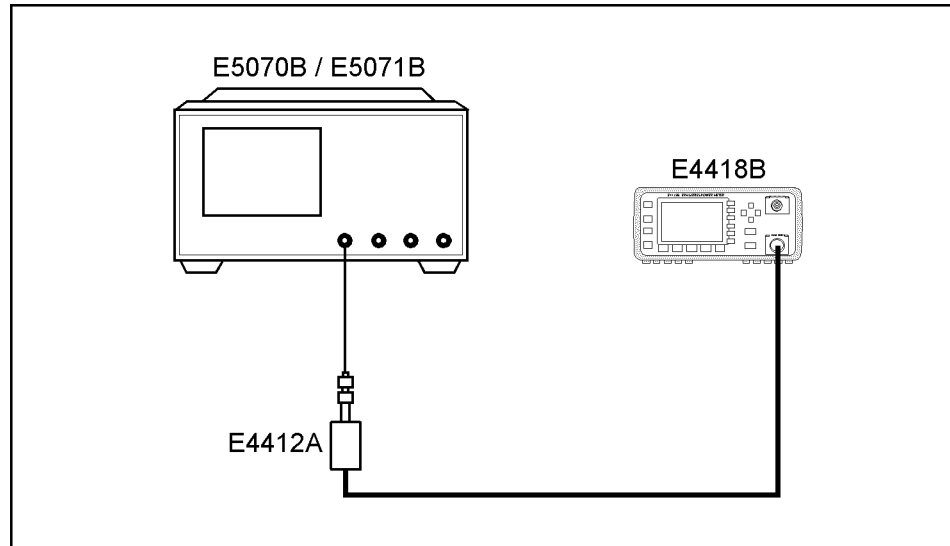

e5070bu006

7. Measuring Calibration Data

Follow this step to measure the calibration data:

Setting Description	Key Operation
Measuring calibration data	<input type="button" value="Cal"/> - Power Calibration - Take Cal Sweep

Measurement Examples
Executing Power Calibration

16 Specifications and Supplemental Information

This chapter provides specifications and supplemental information for the Agilent E5070B/E5071B Network Analyzer.

Definitions

All specifications apply over a 5°C to 40°C range (unless otherwise stated) and 90 minutes after the instrument has been turned on.

Specification (spec.): Warranted performance. Specifications include guardbands to account for the expected statistical performance distribution, measurement uncertainties, and changes in performance due to environmental conditions.

Supplemental information is intended to provide information that is helpful for using the instrument but that is not guaranteed by the product warranty. This information is denoted as either typical or nominal.

Typical (typ.): Expected performance of an average unit that does not include guardbands. It is not guaranteed by the product warranty.

Nominal (nom.): A general, descriptive term that does not imply a level of performance. It is not guaranteed by the product warranty.

Corrected System Performance

The specifications in this section apply for measurements made with the Agilent E5070B/E5071B Network Analyzer under the following conditions:

- No averaging applied to data
- Environmental temperature of 23°C ±5°C, with less than 1°C deviation from the calibration temperature
- Response and isolation calibration not omitted

Table 16-1 System Dynamic Range

Description		Specification	Supplemental Information
System Dynamic Range ^{*1*2}			
300 kHz to 3 MHz	IF bandwidth = 3 kHz		85 dB
3 MHz to 1.5 GHz		95 dB	98 dB
1.5 GHz to 3 GHz		97 dB	100 dB
3 GHz to 4 GHz		96 dB	99 dB
4 GHz to 6 GHz		92 dB	94 dB
6 GHz to 7.5 GHz		87 dB	90 dB
7.5 GHz to 8.5 GHz		80 dB	83 dB
300 kHz to 3 MHz	IF bandwidth = 10 Hz		110 dB
3 MHz to 1.5 GHz		120 dB	123 dB
1.5 GHz to 3GHz		122 dB	125 dB
3 GHz to 4 GHz		121 dB	124 dB
4 GHz to 6 GHz		117 dB	119 dB
6 GHz to 7.5 GHz		112 dB	115 dB
7.5 GHz to 8.5 GHz		105 dB	108 dB

*1. The test port dynamic range is calculated as the difference between the test port rms noise floor and the source maximum output power. The effective dynamic range must take measurement uncertainty and interfering signals into account.

*2. May be limited to 90 dB at particular frequencies below 350MHz or above 4.25GHz due to spurious receiver residuals.

Table 16-2 Corrected System Performance With Type-N Device Connectors, 85032F Calibration Kit

Network analyzer: E5070B/E5071B, Calibration kit: 85032F (Type-N, 50 Ω), Calibration: full 2-port			
IF bandwidth = 10 Hz, No averaging applied to data, Environmental temperature = 23°C±5°C with <1°C deviation from calibration temperature, Isolation calibration not omitted			
Description	Specification (dB)		
	3 MHz to 3 GHz	3 GHz to 6 GHz	6 GHz to 8.5 GHz
Directivity	49	40	38
Source Match	41	36	35
Load Match	49	40	37
Reflection Tracking	±0.011	±0.032	±0.054
Transmission Tracking	±0.016	±0.062	±0.088

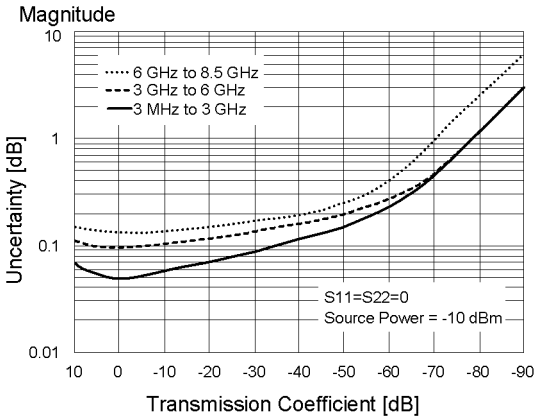
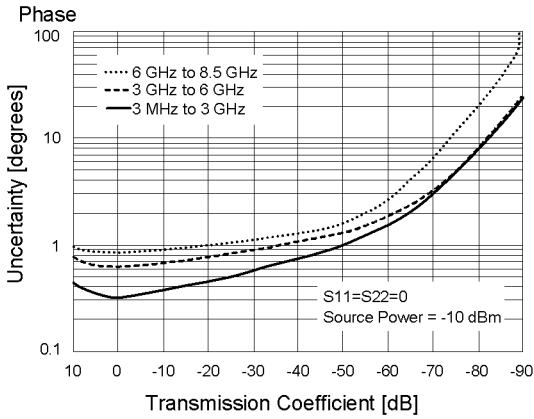
Transmission Uncertainty (Specification)	
 <p>Magnitude</p> <p>Uncertainty [dB]</p> <p>Transmission Coefficient [dB]</p> <p>Legend: 6 GHz to 8.5 GHz (dotted), 3 GHz to 6 GHz (dashed), 3 MHz to 3 GHz (solid)</p> <p>S11=S22=0 Source Power = -10 dBm</p>	 <p>Phase</p> <p>Uncertainty [degrees]</p> <p>Transmission Coefficient [dB]</p> <p>Legend: 6 GHz to 8.5 GHz (dotted), 3 GHz to 6 GHz (dashed), 3 MHz to 3 GHz (solid)</p> <p>S11=S22=0 Source Power = -10 dBm</p>

Reflection Uncertainty (Specification)	
 <p>Magnitude</p> <p>Uncertainty [linear]</p> <p>Reflection Coefficient [linear]</p> <p>Legend: 6 GHz to 8.5 GHz (dotted), 3 GHz to 6 GHz (dashed), 3 MHz to 3 GHz (solid)</p> <p>S21=S12=0 Source Power = -10 dBm</p>	 <p>Phase</p> <p>Uncertainty [degrees]</p> <p>Reflection Coefficient [linear]</p> <p>Legend: 6 GHz to 8.5 GHz (dotted), 3 GHz to 6 GHz (dashed), 3 MHz to 3 GHz (solid)</p> <p>S21=S12=0 Source Power = -10 dBm</p>

Table 16-3 Corrected System Performance With Type-N Device Connectors, 85092C Electronic Calibration Module

Network analyzer: E5070B/E5071B, Calibration module: 85092C (Type-N, 50 Ω) electronic calibration (ECal) module, Calibration: full 2-port			
IF bandwidth = 10 Hz, No averaging applied to data, Environmental temperature = 23°C±5°C with <1°C deviation from calibration temperature, Isolation calibration not omitted			
Description	Specification (dB)		
	3 MHz to 3 GHz	3 GHz to 6 GHz	6 GHz to 8.5 GHz
Directivity	52	52	47
Source Match	45	41	36
Load Match	47	44	39
Reflection Tracking	±0.040	±0.060	±0.070
Transmission Tracking	±0.039	±0.069	±0.136
Transmission Uncertainty (Specification)			
Reflection Uncertainty (Specification)			

Table 16-4 Corrected System Performance With 3.5 mm Device Connector Type, 85033E Calibration Kit

Network analyzer: E5070B/E5071B, Calibration kit: 85033E (3.5 mm, 50 Ω), Calibration: full 2-port			
IF bandwidth = 10 Hz, No averaging applied to data, Environmental temperature = 23°C±5°C with <1°C deviation from calibration temperature, Isolation calibration not omitted			
Description	Specification (dB)		
	3 MHz to 3 GHz	3 GHz to 6 GHz	6 GHz to 8.5 GHz
Directivity	46	38	38
Source Match	43	37	36
Load Match	46	38	38
Reflection Tracking	±0.006	±0.009	±0.010
Transmission Tracking	±0.016	±0.065	±0.079
Transmission Uncertainty (Specification)			
Reflection Uncertainty (Specification)			

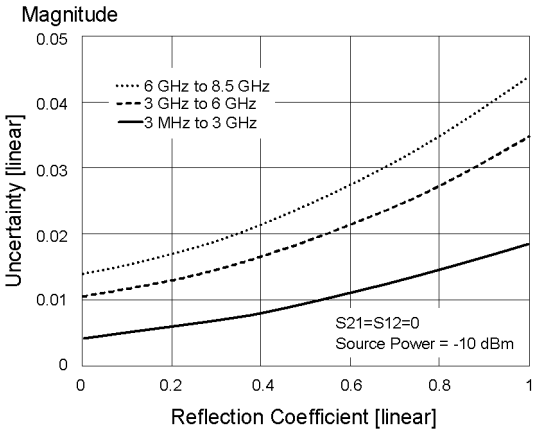
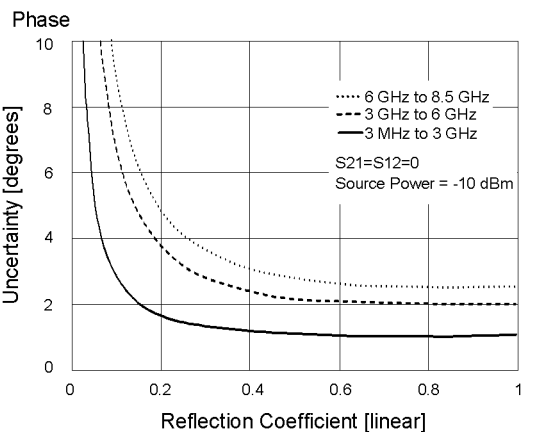
Table 16-5 Corrected System Performance With 3.5 mm Device Connector Type, 85093C Electronic Calibration Module

Network analyzer: E5070B/E5071B, Calibration module: 85093C (3.5 mm, 50 Ω) electronic calibration (ECal) module, Calibration: full 2-port			
IF bandwidth = 10 Hz, No averaging applied to data, Environmental temperature = 23°C±5°C with <1°C deviation from calibration temperature, Isolation calibration not omitted			
Description	Specification (dB)		
	3 MHz to 3 GHz	3 GHz to 6 GHz	6 GHz to 8.5 GHz
Directivity	52	51	47
Source Match	44	39	34
Load Match	47	44	40
Reflection Tracking	±0.030	±0.050	±0.070
Transmission Tracking	±0.039	±0.069	±0.117
Transmission Uncertainty (Specification)			
Reflection Uncertainty (Specification)			

Uncorrected System Performance

Table 16-6 **Uncorrected System Performance (Correction: Off, System Correction: On)**

Description	Specification		
	3 MHz to 3 GHz	3 GHz to 6 GHz	6 GHz to 8.5 GHz
Directivity	25 dB	20 dB	15 dB
Source Match	25 dB	20 dB	15 dB
Load Match	17 dB	12 dB	10 dB
Transmission Tracking	± 1.0 dB	± 1.0 dB	± 1.0 dB
Reflection Tracking	± 1.0 dB	± 1.0 dB	± 1.0 dB

Test Port Output (Source)

Table 16-7 Test Port Output Frequency

Description	Specification	Supplemental Information
Range E5070B E5071B	300 kHz to 3 GHz 300 kHz to 8.5 GHz	
Resolution	1 Hz	
Source Stability Standard Option 1E5		±5 ppm (5°C to 40°C, typical) ±0.05 ppm (23°C±5°C, typical) ±0.5 ppm/year (typical)
CW Accuracy Standard Option 1E5	±5 ppm, 23°C±5°C ±1 ppm, 23°C±5°C	

Table 16-8 Test Port Output Power*¹

Description	Specification	Supplemental Information
Level Accuracy (at 23°C±5°C) 300 kHz to 10 MHz 10 MHz to 8.5 GHz Level Accuracy (high temperature mode: ON) 300 kHz to 8.5 GHz Level Accuracy (swept mode) 300 kHz to 4.25 GHz 4.25 GHz to 8.5 GHz	±0.650 dB (at 0 dBm, 50 MHz absolute, Source attenuator 0 dB) ±1.0 dB (at 0 dBm, relative to 50 MHz reference, Source attenuator 0 dB)	±1.0 dB (at 0 dBm, relative to 50 MHz reference, Source attenuator 0 dB) ±0.8 dB (at 0 dBm, 50 MHz absolute, Source attenuator 0 dB) ±1.5 dB (at 0 dBm, relative to 50 MHz reference, Source attenuator 0 dB) ±2.5 dB (at 0 dBm, relative to 50 MHz reference, Source attenuator 0 dB) ±3.5 dB (at 0 dBm, relative to 50 MHz reference, Source attenuator 0 dB)
Level Linearity (23°C±5°C) 10 MHz to 3 GHz 3 GHz to 4.25 GHz 4.25 GHz to 6 GHz 6 GHz to 8.5 GHz	±0.75 dB (at -15 dBm to 10 dBm) ±0.75 dB (at -15 dBm to 9 dBm) ±0.75 dB (at -15 dBm to 7 dBm) ±0.75 dB (at -15 dBm to 5 dBm)	

Specifications and Supplemental Information
Test Port Output (Source)

Table 16-8 Test Port Output Power^{*1}

Description	Specification	Supplemental Information
Level Linearity (high temperature mode: ON) 300 kHz to 3 GHz 3 GHz to 4.25 GHz 4.25 GHz to 6 GHz 6 GHz to 8.5 GHz		±1.5 dB (at -15 dBm to 10 dBm) ±1.5 dB (at -15 dBm to 9 dBm) ±2.0 dB (at -15 dBm to 7 dBm) ±2.0 dB (at -15 dBm to 5 dBm)
Level Linearity (swept mode) 300 kHz to 3 GHz 3 GHz to 4.25 GHz 4.25 GHz to 6 GHz 6 GHz to 8.5 GHz		±1.5 dB (at -15 dBm to 10 dBm) ±1.5 dB (at -15 dBm to 9 dBm) ±3 dB (at -15 dBm to 7 dBm) ±3 dB (at -15 dBm to 5 dBm)
Range (Source attenuator 0 dB) 300 kHz to 3 GHz 3 GHz to 4.25 GHz 4.25 GHz to 6 GHz 6 GHz to 8.5 GHz 300 kHz to 3 GHz 3 GHz to 4.25 GHz 4.25 GHz to 6 GHz 6 GHz to 8.5 GHz	-15 dBm to 10 dBm -15 dBm to 9 dBm -15 dBm to 7 dBm -15 dBm to 5 dBm	-50 dBm to 10 dBm -50 dBm to 9 dBm -50 dBm to 7 dBm -50 dBm to 5 dBm (non-harmonics spurious may limit power range)
Sweep Range (Source attenuator 0 dB) 300 kHz to 3 GHz 3 GHz to 4.25 GHz 4.25 GHz to 6 GHz 6 GHz to 8.5 GHz	-15 dBm to 10 dBm -15 dBm to 9 dBm -15 dBm to 7 dBm -15 dBm to 5 dBm	-20 dBm to 10 dBm -20 dBm to 9 dBm -20 dBm to 7 dBm -20 dBm to 5 dBm
Level Resolution	0.05 dB	

*1. Source output performance on port 1 only. Other port output performance is typical.

Table 16-9 Test Port Output Signal Purity

Description	Specification	Supplemental Information
Harmonics (2nd or 3rd) 10 MHz to 2 GHz 2 GHz to 3 GHz 3 GHz to 8.5 GHz		< -25 dBc (at 5 dBm, typical) < -15 dBc (at 5 dBm, typical) < -10 dBc (at 5 dBm, typical)
Non-Harmonic Spurious 10 MHz to 3 GHz 3 GHz to 8.5 GHz		< -25 dBc (at 5 dBm, typical) < -10 dBc (at 5 dBm, typical)

Test Port Input

Table 16-10 Test Port Input Levels

Description	Specification	Supplemental Information
Maximum Test Port Input Level		
300 kHz to 3 GHz 3 GHz to 4.25 GHz 4.25 GHz to 6 GHz 6 GHz to 8.5 GHz	+10 dBm +9 dBm +7 dBm +5 dBm	
Damage Level		
300 kHz to 8.5 GHz		RF +20 dBm ^{*1} , ±10 VDC (Source attenuator = 0 dB), ±25 VDC (Source attenuator = 5 dB or more), typical
Crosstalk^{*2}		
3 MHz to 3 GHz 3 GHz to 6 GHz 6 GHz to 7.5 GHz 7.5 GHz to 8.5 GHz	-120 dB -109 dB -99 dB -89 dB	

*1. The damage level for the case, that more than two signal spectra are applied like mixer measurement is summed amplitude of 6.3 Vp-p is the damage level.

*2. Response calibration not omitted.

Table 16-11 Test Port Input (Trace Noise)

Description	Specification	Supplemental Information
Trace Noise ^{*1} Magnitude		
300 kHz to 3 MHz (source power level = +10 dBm)		5 mdB rms (typical) 8 mdB rms (high temperature mode: ON, typical)
3 MHz to 3 GHz (source power level = +10 dBm)	1 mdB rms (23°C±5°C)	4 mdB rms (high temperature mode: ON, typical)
3 GHz to 4.25 GHz (source power level = +9 dBm)	1.2 mdB rms (23°C±5°C)	4.8 mdB rms (high temperature mode: ON, typical)
4.25 GHz to 6 GHz (source power level = +7 dBm)	3.6 mdB rms (23°C±5°C)	7.2 mdB rms (high temperature mode: ON, typical)
6 GHz to 7.5 GHz (source power level = +5 dBm)	3.6 mdB rms (23°C±5°C)	7.2 mdB rms (high temperature mode: ON, typical)
7.5 GHz to 8.5 GHz (source power level = +5 dBm)	6 mdB rms (23°C±5°C)	9.6 mdB rms (high temperature mode: ON, typical)
Trace Noise ^{*1} Phase		
300 kHz to 3 MHz (source power level = +10 dBm)		0.035 ° rms (23°C±5°C, typical) 0.05 ° rms (high temperature mode: ON, typical)
3 MHz to 3 GHz (source power level = +10 dBm)		0.007 ° rms (23°C±5°C, typical) 0.02 ° rms (high temperature mode: ON, typical)
3 GHz to 4.25 GHz (source power level = +9 dBm)		0.008 ° rms (23°C±5°C, typical) 0.024 ° rms (high temperature mode: ON, typical)
4.25 GHz to 6 GHz (source power level = +7 dBm)		0.025 ° rms (23°C±5°C, typical) 0.042 ° rms (high temperature mode: ON, typical)
6 GHz to 7.5 GHz (source power level = +5 dBm)		0.025 ° rms (23°C±5°C, typical) 0.042 ° rms (high temperature mode: ON, typical)
7.5 GHz to 8.5 GHz (source power level = +5 dBm)		0.042 ° rms (23°C±5°C, typical) 0.06 ° rms (high temperature mode: ON, typical)

*1. Trace noise is defined as a ratio measurement of a through, at IFBW = 3 kHz.

Table 16-12 Test Port Input (Stability)

Description	Specification	Supplemental Information
Stability Magnitude^{*1}		
3 MHz to 3 GHz		0.005 dB/°C (at 23 °C±5°C, typical)
3 GHz to 6 GHz		0.01 dB/°C (at 23 °C±5°C, typical)
6 GHz to 8.5 GHz		0.04 dB/°C (at 23 °C±5°C, typical)
Stability Phase^{*1}		
3 MHz to 3 GHz		0.1 °/°C (at 23 °C±5°C, typical)
3 GHz to 6 GHz		0.2 °/°C (at 23 °C±5°C, typical)
6 GHz to 8.5 GHz		0.8 °/°C (at 23 °C±5°C, typical)

*1. Stability is defined as a ratio measurement at the test port.

Table 16-13 Test Port Input (Dynamic Accuracy)

Accuracy of the test port input power reading is relative to -10 dBm reference input power level.	
Specification	Supplemental Information
<p>Magnitude</p> <p>Accuracy [dB]</p> <p>Testport Power [dBm]</p>	<p>Phase</p> <p>Accuracy [degrees]</p> <p>Testport Power [dBm]</p>

Table 16-14 Test Port Input (Group Delay)^{*1}

Description	Specification	Supplemental Information
Aperture (selectable)	(frequency span)/(number of points – 1)	
Maximum Aperture	25% of frequency span	
Minimum Delay		Limited to measuring no more than 180° of phase change within the minimum aperture.
Accuracy		See graph below, typical

The following graph shows group delay accuracy with type-N full 2-port calibration and a 10 Hz IF bandwidth. Insertion loss is assumed to be < 2 dB.

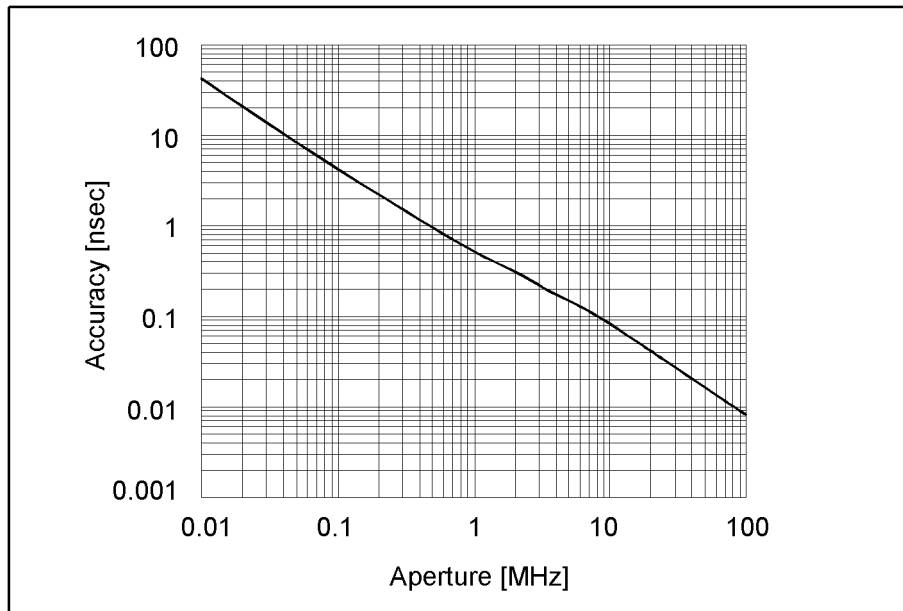

In general, the following formula can be used to determine the accuracy, in seconds, of specific group delay measurement:

$$\pm \text{Phase Accuracy (deg)} / [360 \times \text{Aperture (Hz)}]$$

*1. Group delay is computed by measuring the phase change within a specified step (determined by the frequency span and the number of points per sweep).

General Information

Table 16-15 System Bandwidths

Description	Supplemental Information
IF Bandwidth Settings	
Range	10 Hz to 100 kHz Nominal settings are: 10, 15, 20, 30, 40, 50, 70, 100, 150, 200, 300, 400, 500, 700, 1k, 1.5k, 2k, 3k, 4k, 5k, 7k, 10k, 15k, 20k, 30k, 40k, 50k, 70k, 100kHz

Table 16-16 Front Panel Information

Description	Supplemental Information
RF Connectors	
Type	Type-N, female, 50 Ω (nominal)
Display	
Size	10.4 in TFT color LCD
Resolution	VGA (640 × 480) ^{*1}

*1. Valid pixels are 99.99 % and more. Below 0.01 % (approx. 30 points) of fixed points of black, blue, green or red are not regarded as failure.

Table 16-17 Rear Panel Information

Description	Supplemental Information
External Trigger Connector	
Type	BNC, female
Input level	LOW threshold voltage: 0.5 V HIGH threshold voltage: 2.1 V Input level range: 0 to + 5 V
Pulse width	≥ 2 μ sec, typical
Polarity	Negative (downward) only
External Reference Signal Input Connector	
Type	BNC, female
Input Frequency	10 MHz \pm 10 ppm, typical
Input Level	0 dBm \pm 3 dB, typical
Internal Reference Signal Output Connector	
Type	BNC, female
Output Frequency	10 MHz \pm 10 ppm, typical
Signal Type	Sine Wave, typical
Output Level	0 dBm \pm 3 dB into 50 Ω , typical
Output Impedance	50 Ω , nominal
VGA Video Output	15-pin mini D-Sub; female; drives VGA compatible monitors
GPIB	24-pin D-Sub (Type D-24), female; compatible with IEEE-488
Parallel Port	36-pin D-Sub (Type 1284-C), female; provides connection to printers
USB-Host Port	
Contact 1	Universal Serial Bus jack, Type A configuration (4 contacts inline, contact 1 on left); female; provides connection to printer, ECal module, USB/GPIB interface or multiport test set Vcc: 4.75 to 5.25 VDC, 500 mA, maximum -Data +Data Ground
Contact 2	
Contact 3	
Contact 4	
USB (USBTMC^{*1}) interface Port	Universal Serial Bus jack, Type B configuration (4 contacts inline); female; provides connection to an external PC; compatible with USBTMC-USB488 and USB 2.0.
LAN	10/100BaseT Ethernet, 8-pin configuration; auto selects between the two data rates

Table 16-17 Rear Panel Information

Description	Supplemental Information
Handler I/O Port	36-pin centronics, female; provides connection to handler system
Line Power*2	
Frequency	47 Hz to 63 Hz
Voltage	90 to 132 VAC, or 198 to 264 VAC (automatically switched)
VA Max	350 VA max.

*1. USB Test and Measurement Class (TMC) interface that communicates over USB, complying with the IEEE 488.1 and IEEE 488.2 standards.

*2. A third-wire ground is required.

Table 16-18 EMC, Safety and Environment



Description	Supplemental Information
EMC	
 ISM 1-A	European Council Directive 89/336/EEC, 93/68/EEC IEC 61326-1:1997 +A1:1998 / EN 61326-1:1997 +A1:1998 CISPR 11:1997 +A1:1999 / EN 55011:1998 +A1:1999 Group 1, Class A IEC 61000-4-2:1995 / EN 61000-4-2:1995 +A1:1998 4 kV CD / 8 kV AD IEC 61000-4-3:1995 / EN 61000-4-3:1996 +A1:1998 3 V/m, 80-1000 MHz, 80% AM IEC 61000-4-4:1995 / EN 61000-4-4:1995 1 kV power / 0.5 kV Signal IEC 61000-4-5:1995 / EN 61000-4-5:1995 0.5 kV Normal / 1 kV Common IEC 61000-4-6:1996 / EN 61000-4-6:1996 3 V, 0.15-80 MHz, 80% AM IEC 61000-4-11:1994 / EN 61000-4-11:1994 100% 1cycle Note: The performance criterion B is adopted for ESD immunity test, and criterion A for other immunity tests. Temporary deviation from test limit due to accidental measurement of test signal is considered normal performance.
ICES/NMB-001	This ISM device complies with Canadian ICES-001. Cet appareil ISM est conforme à la norme NMB-001 du Canada.
 N10149	AS/NZS 2064.1/2 Group 1, Class A
Safety	

Table 16-18 EMC, Safety and Environment



Description	Supplemental Information
	<p>European Council Directive 73/23/EEC IEC 61010-1:1990+A1+A2 / EN 61010-1:1993+A2 INSTALLATION CATEGORY II, POLLUTION DEGREE 2 INDOOR USE IEC60825-1:1994 CLASS 1 LED PRODUCT</p>
	<p>CAN/CSA C22.2 No. 1010.1-92</p>
<p>Environment</p>	
	<p>This product complies with the WEEE Directive (2002/96/EC) marking requirements. The affixed label indicates that you must not discard this electrical/ electronic product in domestic household waste.</p> <p>Product Category : With reference to the equipment types in the WEEE Directive Annex I, this product is classed as a “Monitoring and Control instrumentation” product.</p> <p>Do not dispose in domestic household waste.</p> <p>To return unwanted products, contact your local Agilent office, or see www.agilent.com/environment/product/ for more information.</p>

Table 16-19 Analyzer Environment and Dimensions

Description	Supplemental Information
Operating Environment	
Temperature	+5 °C to +40 °C
Error-Corrected Temperature Range	23 °C ± 5 °C with < 1°C deviation from calibration temperature
Humidity	20% to 80% at wet bulb temperature < +29 °C (non-condensing)
Altitude	0 to 2,000 m (0 to 6,561 feet)
Vibration	0.21 G maximum, 5 Hz to 500 Hz
Non-Operating Storage Environment	
Temperature	-10 °C to +60 °C
Humidity	20% to 90% at wet bulb temperature < +40 °C (non-condensing)
Altitude	0 to 4,572 m (0 to 15,000 feet)
Vibration	0.5 G maximum, 5 Hz to 500 Hz
Dimensions	See Figure 16-1 through Figure 16-5.
Weight (Net)	17.5 kg (Option 213/214, nominal) 19.5 kg (Option 413/414, nominal)

Figure 16-1 Dimensions (front view, E5071B with Option 413, in millimeters, nominal)

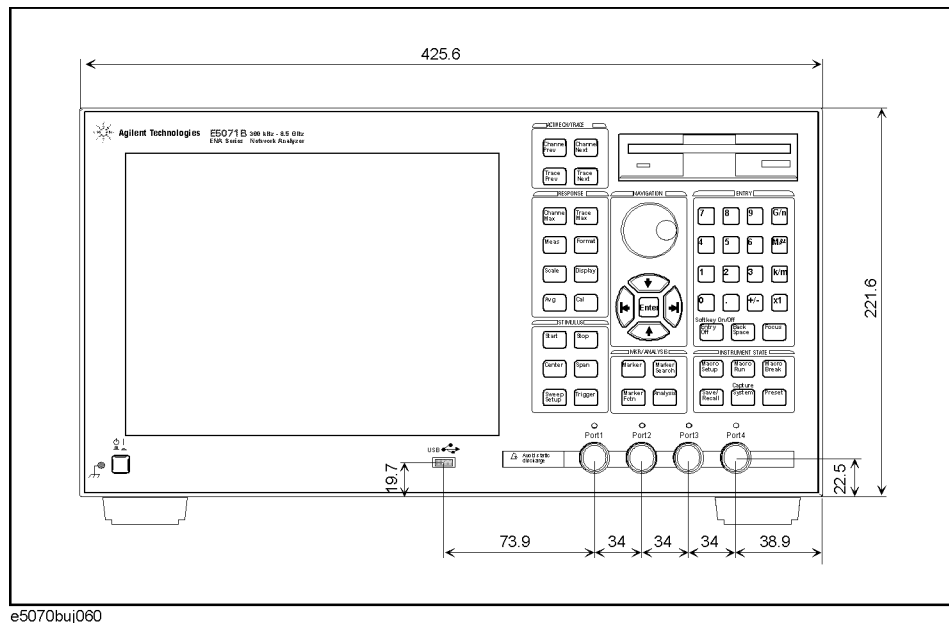
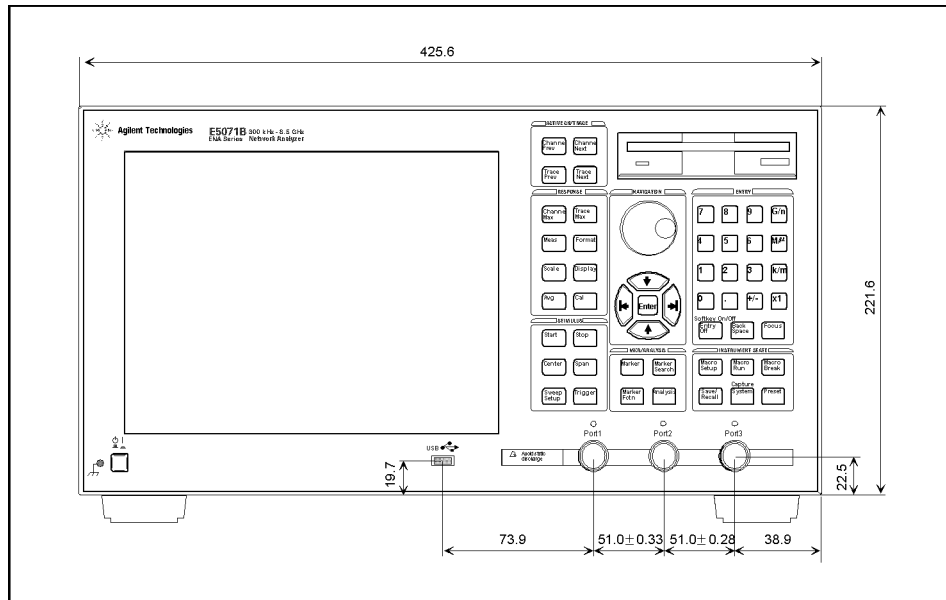

Figure 16-2

Dimensions (front view, E5071B with Option 313, in millimeters, nominal)



e5070buj078

Figure 16-3

Dimensions (front view, E5071B with Option 213, in millimeters, nominal)

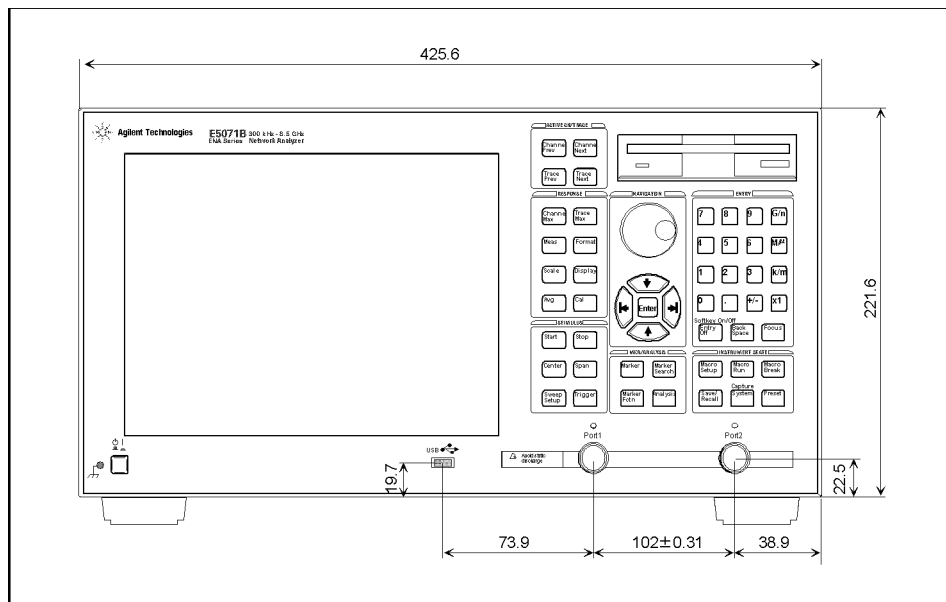

e5070buj079

Figure 16-4 Dimensions (rear view, with Option 1E5, in millimeters, nominal)

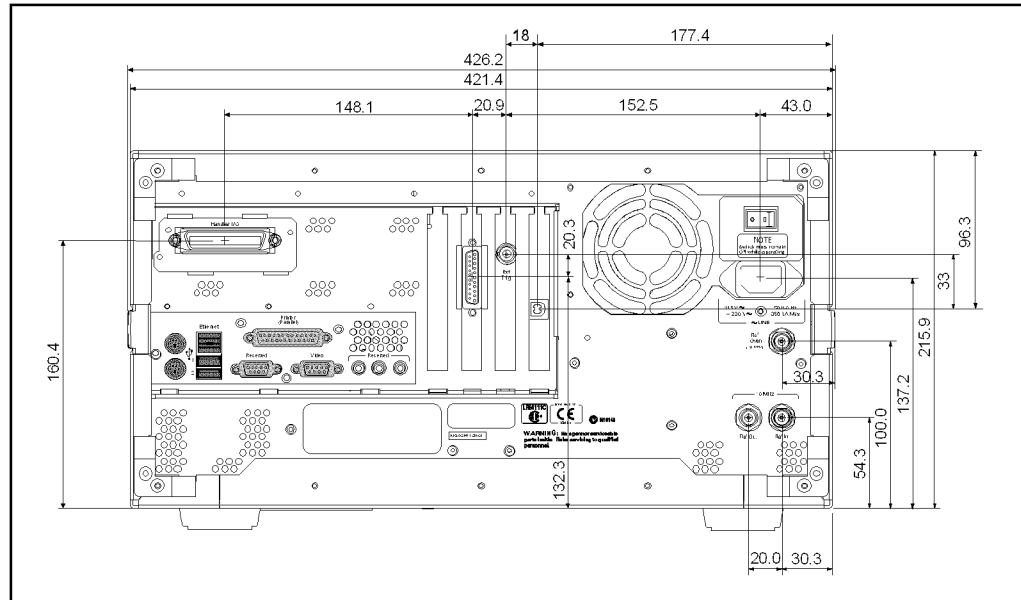

e5070buj7011

Figure 16-5 Dimensions (side view, in millimeters, nominal)

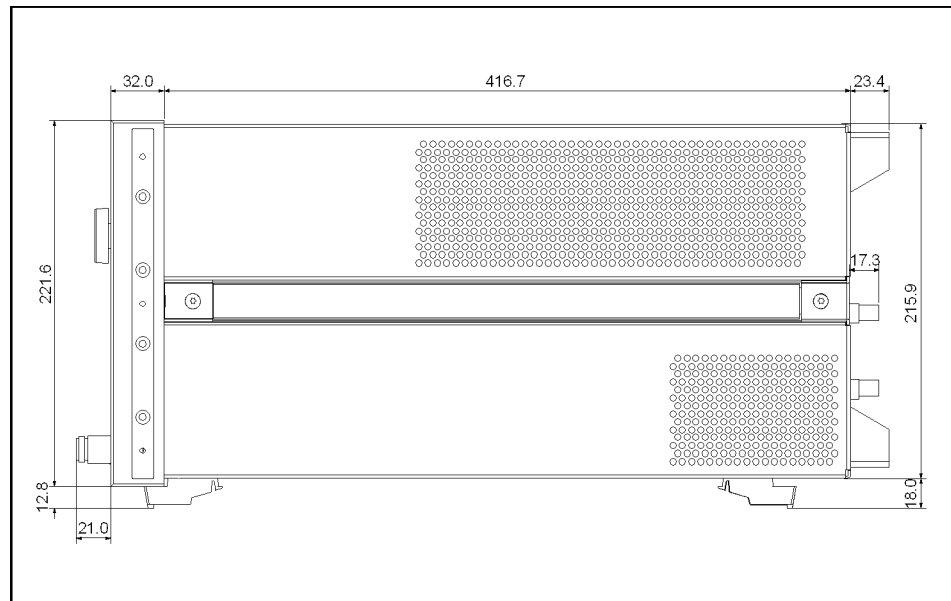

e5070buj7012

Figure 16-6

Dimensions (top view, in millimeters, nominal)

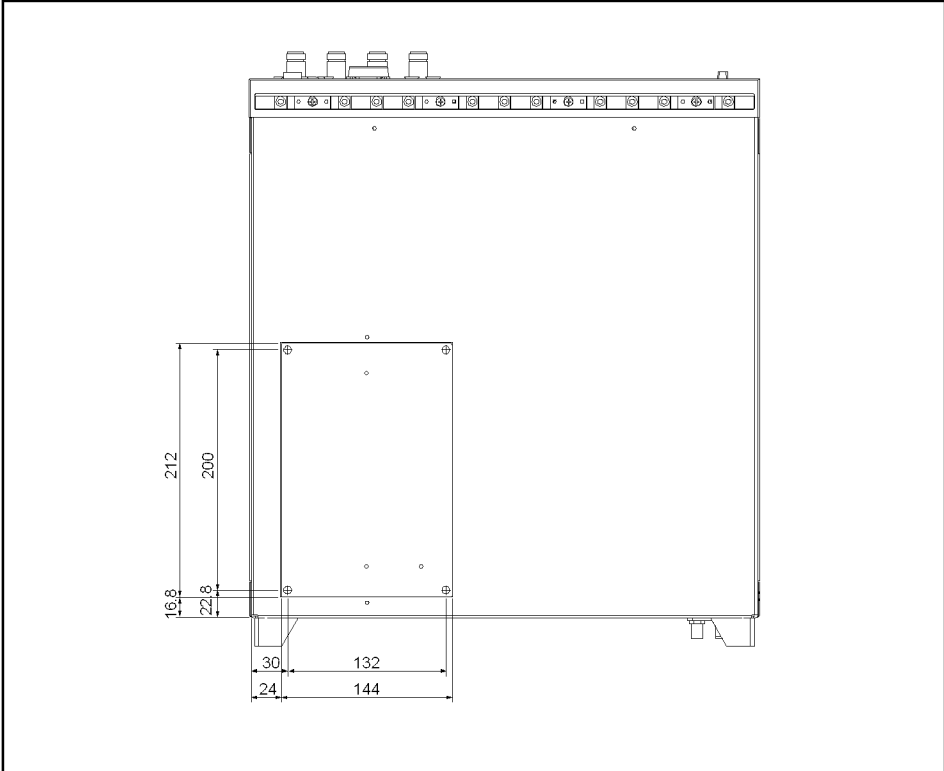

e5070buj7014

Measurement Throughput Summary

Table 16-20 Typical Cycle Time for Measurement Completion^{*1*2} (ms)

	Number of Points			
	51	201	401	1601
Start 1 GHz, Stop 1.2 GHz, 100 kHz IF bandwidth				
Uncorrected	4	5	7	18
2-port cal	5	8	13	42
Start 300 kHz, Stop 3 GHz, 100 kHz IF bandwidth				
Uncorrected	11	12	13	23
2-port cal	20	23	25	46
Start 300 kHz, Stop 8.5 GHz, 100 kHz IF bandwidth				
Uncorrected	19	24	24	24
2-port cal	37	46	48	50

*1. Typical performance.

*2. Sweep mode: Fast swept. Analyzer display turned off with :DISP:ENAB OFF. Number of traces = 1. System error correction: OFF.

Table 16-21 Typical Cycle Time for Measurement Completion^{*1*2} (ms)

	Number of Points			
	51	201	401	1601
Start 1 GHz, Stop 1.2 GHz, 100 kHz IF bandwidth				
Uncorrected	4	6	8	22
2-port cal	5	10	16	56
Start 300 kHz, Stop 3 GHz, 100 kHz IF bandwidth				
Uncorrected	11	12	13	23
2-port cal	20	24	25	55
Start 300 kHz, Stop 8.5 GHz, 100 kHz IF bandwidth				
Uncorrected	20	24	24	26
2-port cal	37	46	47	57

*1. Typical performance.

*2. Sweep mode: Fast swept. Analyzer display turned off with :DISP:ENAB OFF. Number of traces = 1. System error correction: ON.

Specifications and Supplemental Information
Measurement Throughput Summary

Table 16-22 Typical Cycle Time for Measurement Completion^{*1*2} (ms)

	Number of Points			
	51	201	401	1601
Start 1 GHz, Stop 1.2 GHz, 100 kHz IF bandwidth				
Uncorrected	7	17	29	90
2-port cal	12	32	55	178
Start 300 kHz, Stop 3 GHz, 100 kHz IF bandwidth				
Uncorrected	14	27	43	130
2-port cal	26	50	84	258
Start 300 kHz, Stop 8.5 GHz, 100 kHz IF bandwidth				
Uncorrected	16	30	49	146
2-port cal	30	57	96	291

*1. Typical performance.

*2. Sweep mode: Std Stepped. Analyzer display turned off with :DISP:ENAB OFF. Number of traces = 1. System error correction: ON

Table 16-23 Cycle Time (ms)^{*1*2} vs. Number of Points

Number of Points	Sweep mode: Fast Swept System error correction: OFF	Sweep mode: Fast Swept System error correction: ON	Sweep mode: Std Stepped System error correction: ON
3	4	4	4
11	4	4	4
51	4	4	7
101	4	5	11
201	5	6	17
401	8	8	29
801	11	13	52
1601	18	23	90

*1. Typical performance.

*2. Start 1 GHz, Stop 1.2 GHz, 100 kHz IF bandwidth, Error correction: OFF, Display update: OFF, Number of traces = 1.

Table 16-24 Data Transfer Time^{*1} (ms)

	Number of Points			
	51	201	401	1601
SCPI over GPIB^{*2}				
64-bit floating point	5	16	29	109
ASCII	21	79	156	617
SCPI over 100 Mbps LAN (Telnet)^{*2}				
REAL 64	2	2	3	5
ASCII	34	128	254	995
SCPI over 100 Mbps LAN (SICL-LAN)^{*2}				
REAL 64	4	4	5	8
ASCII	6	14	26	95
SCPI over USB (SICL-USB)^{*3}				
REAL 64	4	4	5	8
ASCII	6	14	26	95
COM^{*4}				
Variant type	1	1	1	1

*1. Typical performance.

*2. Measured using a VEE 6.0 program running on a 733 MHz Pentium III HP Kayak, Transferred complex S_{11} data, using :CALC{1-16}:DATA:SDAT?.

*3. Measured using a VEE 7.0 program running on a 500 MHz Pentium III DELL Opt-Plex, Transferred complex S_{11} data, using :CALC{1-16}:DATA:FDAT?.

*4. Measured using an E5070B/E5071B VBA macro running inside the analyzer. Transferred complex S_{11} data.

Measurement capabilities

Number of measurement channels	Up to 16 independent measurement channels. A measurement channel is coupled to stimulus response settings including frequency, IF bandwidth, power level, and number of points.
Number of display windows	Each measurement channel has a display window. Up to 16 display windows (channels) can be displayed.
Number of traces	Four display modes (selectable) 16 data traces and 16 memory traces per channel at 4-channel mode 9 data traces and 9 memory traces per channel at 9-channel mode 6 data traces and 6 memory traces per channel at 12-channel mode 4 data traces and 4 memory traces per channel at 16-channel mode
Measurement choices	Opt. 213/214: S_{11} , S_{21} , S_{12} , S_{22} Opt. 313/314: S_{11} , S_{21} , S_{31} , S_{12} , S_{22} , S_{32} , S_{13} , S_{23} , S_{33} , Mixed-mode S-parameters, Balance parameters, CMRR Opt. 413/414: S_{11} , S_{21} , S_{31} , S_{41} , S_{12} , S_{22} , S_{32} , S_{42} , S_{13} , S_{23} , S_{33} , S_{43} , S_{14} , S_{24} , S_{34} , S_{44} , Mixed mode S-parameters, Balance parameters, CMRR
Measurement parameter conversion	Available to convert S-parameters into reflection impedance, transmission impedance, reflection admittance, transmission admittance, and 1/S.
Data formats	Log magnitude, linear magnitude, phase, extended phase, positive phase, group delay, SWR, real, imaginary, Smith chart, polar.
Data markers	10 independent markers per trace. Reference marker available for delta marker operation. Smith chart format includes 5 marker formats: linear magnitude/phase, log magnitude/phase, real/imaginary, $R + jX$, and $G + jB$. Polar chart format includes 3 marker formats: linear magnitude/phase, log magnitude/phase, and real/imaginary.
Marker functions	
Marker search	Max value, Min value, peak, peak left, peak right, target, target left, target right, bandwidth parameters with user-defined bandwidth values.
Marker-to functions	Set start, stop, center to active marker stimulus value; set reference to active marker response value; set electrical delay to group delay at active marker.
Search range	User definable.
Tracking	Performs marker search continuously or on demand.
Time domain functions	
Transformation	Selectable transformation type from bandpass, lowpass impulse, lowpass step. Selectable window from maximum, normal and minimum.
Gated functions	Selectable gated filter type from bandpass, notch. Selectable gate shape from maximum, normal and wide.

Source control

Measured number of points per sweep	User definable from 2 to 1601.
Sweep mode	Normal stepped, normal swept, fast stepped and fast swept.
Sweep type	Linear sweep, segment sweep, log sweep and power sweep.
Segment sweep	Define independent sweep segments. Set number of points, test port power levels, IF bandwidth, delay time, sweep time and sweep mode independently for each segment.
Sweep trigger	Set to continuous, hold, or single, sweep with internal, external, manual, or bus trigger.
Power	Set source power from -15 dBm (-50 dBm for option 214/314/414) to 10 dBm. The power slope function and the power calibration function compensate source power level error.

Trace functions

Display data	Display current measurement data, memory data, or current measurement and memory data simultaneously.
Trace math	Vector addition, subtraction, multiplication or division of measured complex values and memory data.
Title	Add custom title to each channel window. Titles are printed on hardcopies of displayed measurements.
Autoscale	Automatically selects scale resolution and reference value to vertically center the trace.
Electrical delay	Offset measured phase or group delay by a defined amount of electrical delay, in seconds.
Phase Offset	Offset measured phase or group delay by a defined amount in degrees.
Statistics	Calculates and displays mean, standard deviation and peak-to-peak deviation of the data trace.

Data accuracy enhancement

Measurement calibration	Measurement calibration significantly reduces measurement uncertainty due to errors caused by system directivity, source and load match, tracking and crosstalk. Full 2-port, 3-port, or 4-port calibration removes all the systematic errors for the related test ports to obtain the most accurate measurements.
Calibration types available	
Response	Simultaneous magnitude and phase correction of frequency response errors for either reflection or transmission measurements.
Response and isolation	Compensates for frequency response and crosstalk errors of transmission measurements.
Enhanced response	Compensates for frequency response and source match errors.
One-port calibration	Available on test port 1, port 2, port 3, or port 4 to correct for directivity, frequency response and source match errors.
Full 2-port/3-port/4-port calibration TRL calibration	Compensates for directivity, source match, reflection tracking, load match, transmission tracking and crosstalk. Crosstalk calibration can be omitted.
Interpolated error correction	With any type of accuracy enhancement applied, interpolated mode recalculates the error coefficients when the test frequencies are changed. The number of points can be increased or decreased and the start/stop frequencies can be changed.
Velocity factor	Enter the velocity factor to calculate the equivalent physical length.
Reference port extension	Redefine the measurement plane from the plane where the calibration was done.

Storage

Internal hard disk drive	Store and recall instrument states, calibration data, and trace data on 3 GB, minimum, internal hard drive. Trace data can be saved in CSV (comma separated value) format. All files are MS-DOS® -compatible. Instrument states include control settings, limit lines, segment sweep tables, and memory trace data.
File sharing	Internal hard disk drive (D:) can be accessed from an external Windows® PC through LAN. And The hard disk drive of an external Windows® PC can be accessed from the analyzer through LAN.
Disk drive	Instrument states, calibration data, and trace data can be stored on an internal 3.5 inch 1.4MB floppy disk in MS-DOS® -compatible format.
Screen hardcopy	Printouts of instrument display are directly produced on a printer. The analyzer provides USB and parallel interfaces.

System capabilities

Familiar graphical user interface	The ENA Series analyzer employs a graphical user interface based on the Windows® operating system. There are three ways to operate the instrument manually: you can use a hardkey interface, a touch screen interface (Opt. 016), or a mouse interface.
Limit lines	Define the test limit lines that appear on the display for pass/fail testing. Defined limits may be any combination of horizontal/sloping lines and discrete data points.
Fixture Simulator	
Balanced-unbalanced conversion	Convert data from single-ended measurement to balanced measurement parameters (mixed-mode S-parameters), balance parameter or CMRR by using internal software.
Network De-embedding	De-embed an arbitrary circuit defined by a two-port Touchstone data file for each test port. This function eliminates error factors between the calibration plane and DUT and expands the calibration plane for each test port. This function can be used with the port extension function.
4-port Network Embedding/De-embedding	Embed or de-embed an arbitrary circuit defined by a four-port Touchstone data file.
Port reference impedance conversion	Convert S-parameters measured in 50 Ω reference impedance to data in other reference impedance levels by using internal software. This conversion can be performed for both single-ended (unbalanced) measurement ports and converted balanced measurement ports.
Matching circuit	Add one of the predefined matching circuits or a circuit defined by a two-port Touchstone data file to each single-ended test port or converted balanced (differential) test port by using internal software.

Automation

Methods	
Internal analyzer execution	Applications can be developed in a built-in VBA® (Visual Basic for Applications) language. Applications can be executed from within the analyzer via COM (component object model) or using SCPI.
Controlling via GPIB	The GPIB interface operates to IEEE 488.2 and SCPI protocols. The analyzer can be controlled by a GPIB external controller. The analyzer can control external devices using a USB/GPIB interface.
LAN	
Standard conformity	10 Base-T or 100 Base-TX (automatically switched), Ethertwist, RJ45 connector
Protocol	TCP/IP
Function	Telnet, SICL-LAN

17 Measurement Accessories

This chapter introduces the accessories that can be used with the Agilent E5070B/E5071B for various measurements.

Test Port Cables

The following cables are used to connect the DUT and the network analyzer.

N6314A 50 Ω N Type RF Cable (300 kHz ~ 9 GHz)

An RF cable 610 mm in length with male N type connectors on both ends.

N6315A 50 Ω N Type RF Cable (300 kHz ~ 9 GHz)

An RF cable 610 mm in length with a male and a female N type connector on each end.

Calibration Kits

Calibration kits are used to improve the accuracy of the analyzer in various measurements.

Two types of calibration kit – the coaxial mechanical calibration kit and coaxial electronic calibration kit – are available. Each kit comes with N type connectors or 3.5 mm (SMA) connectors.

The electronic type reduces the time required for calibration, mis-connections, and wear on connectors since it requires fewer changes of connection than the mechanical type.

Specifications for calibration kits and the availability of particular calibration kits are subject to change without prior notice. Contact the nearest Agilent Technology sales office or the supplier of your analyzer for more information before placing an order.

For Devices with N Type Connectors

Coaxial Mechanical Calibration Kits

85032F Mechanical Calibration Kit N Type 50 Ω (30 kHz ~ 9 GHz)

The 85032F kit includes the following items.

Agilent Cat. No.	Description
85032-60017	50 Ω N type (m), terminated
85032-60018	50 Ω N type (f), terminated
85032-60013	50 Ω N type (m), open
85032-60014	50 Ω N type (f), open
85032-60016	50 Ω N type (m), short
85032-60015	50 Ω N type (f), short

Also, the following options are available for the 85032F.

Option	Agilent Cat. No.	Description
Option 100	85032-60021	With a 50 Ω N type (f)-(f) adaptor.
Option 200	85032-60019	With a 50 Ω N type (m)-(m) adaptor.
Option 300	85032-60020	With a N type (m)-(f) adaptor.
Option 500	85054-60001	With two 50 Ω N type (f) to 7 mm adaptors.
	85054-60009	With two 50 Ω N type (m) to 7 mm adaptors.

Measurement Accessories
Calibration Kits

85054D Economy Mechanical Calibration Kit N Type (dc ~ 18 GHz)

The 85054D includes the followings.

Agilent Cat. No.	Description
85054-60025	N type (m), short
85054-60026	N type (f), short
85054-60027	N type (m), open
85054-60028	N type (f), open
85054-60031	N type (f) to 7 mm adaptor
85054-60032	N type (m) to 7 mm adaptor
85054-60037	N type (f)-(f) adaptor
85054-60038	N type (m)-(m) adaptor
85054-60046	N type (m), terminated
85054-60047	N type (f), terminated

85036B Mechanical Calibration Kit N Type 75 Ω (dc ~ 3 GHz)

The 85036B kit includes the following items.

Agilent Cat. No.	Description
00909-60019	75 Ω N type (m), broadband load
00909-60020	75 Ω N type (f), broadband load
85036-60012	75 Ω N type (m), short
85036-60011	75 Ω N type (f), short
85032-60007	75 Ω N type (m), open
85032-20001	75 Ω N type (f), open body
85036-60019	75 Ω N type (f), open center conductor extender
85036-60013	75 Ω N type (m)-(m) adaptor
85036-60014	75 Ω N type (f)-(f) adaptor
85036-60015	75 Ω N type (m)-(f) adaptor

85036E Mechanical Calibration Kit N Type 75 Ω (dc ~ 3 GHz)

The 85036E kit includes the following items.

Agilent Cat. No.	Description
00909-60019	75 Ω N type (m), broadband load
85036-60016	75 Ω N type (m), combination open/short

Coaxial Electronic Calibration Kits

85092C RF Two-Port ECal Module (300 kHz ~ 9 GHz)

Option	Description
Option M0F	Module with 50 Ω N type (m)/N type (f) connectors
Option 00M	Module with 50 Ω N type (m)/N type (m) connectors
Option 00F	Module with 50 Ω N type (f)/N type (f) connectors

N4431A RF Four-Port ECal Module (300 kHz ~ 9 GHz)

Option	Description
Option 020	Module with four 50 Ω N type (f) connectors

For Devices with 3.5 mm (SMA) Connectors

Coaxial Mechanical Calibration Kits

85033E Mechanical Calibration Kit 3.5 mm 50 Ω (30 kHz ~ 9 GHz)

The 85033E kit includes the following items.

Agilent Cat. No.	Description
85033-60016	3.5 mm (m), terminated
85033-60017	3.5 mm (f), terminated
85033-60018	3.5 mm (m), open
85033-60019	3.5 mm (f), open
85033-60020	3.5 mm (m), short
85033-60021	3.5 mm (f), short
8710-1761	Torque wrench

Also, the following options are available for the 85033E.

Option	Agilent Cat. No.	Description
Option 100	85027-60005	With a 3.5 mm (f)-(f) adaptor.
Option 200	85027-60007	With a 3.5 mm (m)-(m) adaptor.
Option 300	85027-60006	With a 3.5 mm (m)-(f) adaptor.
Option 400	1250-1744	With a 3.5 mm (f) to N type 50 Ω (m) adaptor.
	1250-1743	With a 3.5 mm (m) to N type 50 Ω (m) adaptor.
	1250-1745	With a 3.5 mm (f) to N type 50 Ω (f) adaptor.
	1250-1750	With a 3.5 mm (m) to N type 50 Ω (f) adaptor.
Option 500	1250-1746	With two 3.5 mm (m) to 7 mm adaptors.
	1250-1747	With two 3.5 mm (f) to 7 mm adaptors.

85052C Mechanical Calibration Kit 3.5 mm (45 MHz ~ 26.5 GHz)

The 85052C kit includes the following items.

Agilent Cat. No.	Description
00902-60003	3.5 mm (m), terminated
00902-60004	3.5 mm (f), terminated
85052-60006	3.5 mm (m), short
85052-60007	3.5 mm (f), short
85052-60008	3.5 mm (m), open
85052-60009	3.5 mm (f), open
85052-60032	3.5 mm (f)-(f) adaptor
85052-60033	3.5 mm (m)-(m) adaptor
85052-60034	3.5 mm (f)-(m) adaptor
85052-60035	3.5 mm high-precision short airline
85052-60036	3.5 mm high-precision long airline

85052D Economy Mechanical Calibration Kit 3.5 mm (45 MHz to 26.5 GHz)

The 85052D kit includes the following items.

Agilent Cat. No.	Description
00902-60003	3.5 mm (m), terminated
00902-60004	3.5 mm (f), terminated
85052-60006	3.5 mm (m), short
85052-60007	3.5 mm (f), short
85052-60008	3.5 mm (m), open
85052-60009	3.5 mm (f), open
85052-60012	3.5 mm (f)-(f) adaptor
85052-60013	3.5 mm (f)-(m) adaptor
85052-60014	3.5 mm (m)-(m) adaptor

Measurement Accessories
Calibration Kits

Coaxial Electronic Calibration Kits

85093C RF Two-Port ECal Module (300 kHz ~ 9 GHz)

Option	Description
Option M0F	Module with 3.5 mm (m)/3.5 mm (f) connectors
Option 00M	Module with 3.5 mm (m)/3.5 mm (m) connectors
Option 00F	Module with 3.5 mm (f)/3.5 mm (f) connectors

N4431A RF Four-Port ECal Module (300 kHz ~ 9 GHz)

Option	Description
Option 010	Module with four 3.5 mm (f) connectors

For Devices with 7 mm Connectors

Coaxial Mechanical Calibration Kits

85031B Mechanical Calibration Kit 7 mm 50 Ω (300 kHz ~ 6 GHz)

The 85031B kit includes the following items.

Agilent Cat. No.	Description
00909-60008	7 mm , broadband load
85031-60001	7 mm , combination open/short

85050C Mechanical Calibration Kit 7 mm 50 Ω (45 MHz ~ 18 GHz)

The 85050C kit includes the following items.

Agilent Cat. No.	Description
00909-60008	7 mm , lowband load
85050-60003	7 mm , airline
85050-60005	TRL 7 mm - 7mm, adaptor
85050-60006	7 mm , broadband load
85050-80008	7 mm , short(threaded center conductor style)
85050-80009	7 mm , short(collet style)
85052-80010	7 mm , open

85050D Mechanical Calibration Kit 7 mm 50 Ω (45 MHz ~ 18 GHz)

The 85050D kit includes the following items.

Agilent Cat. No.	Description
85050-60006	7 mm , broadband load
85050-80007	7 mm , short
85052-80010	7 mm , open

For Devices with 7-16 Connectors

Coaxial Mechanical Calibration Kits

85038A Mechanical Calibration Kit 7-16 50 Ω (DC ~ 7.5 GHz)

The 85038A kit includes the following items.

Agilent Cat. No.	Description
85038-80007	7-16 (m) broadband load
85038-80006	7-16 (f) broadband load
85038-80005	7-16 (m) short
85038-80004	7-16 (f) short
85038-80003	7-16 (m) open
85038-80002	7-16 (f) open

85038F Mechanical Calibration Kit 7-16 50 Ω (DC ~ 7.5 GHz)

The 85038F kit includes the following items.

Agilent Cat. No.	Description
85038-80006	7-16 (f) broadband load
85038-80004	7-16 (f) short
85038-80002	7-16 (f) open
11906-80016	7-16 (f) - (f) adaptor

85038M Mechanical Calibration Kit 7-16 50 Ω (DC ~ 7.5 GHz)

The 85038M kit includes the following items.

Agilent Cat. No.	Description
85038-80007	7-16 (m) broadband load
85038-80005	7-16 (m) short
85038-80003	7-16 (m) open
11906-80015	7-16 (m) - (m) adaptor

Adaptors

11853A 50 Ω N Type Accessory Kit

The 11853A kit includes the following items.

Agilent Cat. No.	Description
1250-1472	N type (f)-(f) adaptor kit (two adaptors)
1250-1475	N type (m)-(m) adaptor kit (two adaptors)
11511A	N type (f), short
11512A	N type (m), short

11878A N type to 3.5 mm Adaptor Kit

The 11878A kit includes the following items.

Agilent Cat. No.	Description
1250-1744	3.5 mm (f) to N type 50 Ω (m) adaptor
1250-1743	3.5 mm (m) to N type 50 Ω (m) adaptor
1250-1745	3.5 mm (f) to N type 50 Ω (f) adaptor
1250-1750	3.5 mm (m) to N type 50 Ω (f) adaptor

11854A 50 Ω BNC Accessory Kit

The 11854A kit includes the following items.

Agilent Cat. No.	Description
1250-0929	BNC (m), short
1250-1473	BNC (m) to N type (m) adaptor kit (two adaptors)
1250-1474	BNC (f) to N type (f) adaptor kit (two adaptors)
1250-1476	BNC (f) to N type (m) adaptor kit (two adaptors)
1250-1477	BNC (m) to N type (f) adaptor kit (two adaptors)

11852B Minimum-loss pad

Option	Description
Option 004	N type connectors, 50 Ω (m) to 75 Ω (f)

System Accessories

System Racks and Cases

Option	Agilent Cat. No.	Description
Option 1CN	5063-9229	Handle kit (two handles)
Option 1CM	5063-9216	Rack mount kit (without handles)
Option 1CP	5063-9223	Rack mount/handle kit
	E3663AC	Rack mount rail kit (with a rack mount kit and a handle kit)
	9211-2658	Transit case

CAUTION

When installing the Rack mount/handle kit (Option 1CP), please follow the prescribed procedure, or it could result in damage the instrument.

Please refer to the Installation and Quick Start Guide chapter 2, “how to Install the Rack-mount and Handle Kit (Option 1CP)” for more detail.

GP-IB Cables

The following GPIB cables can be used to connect the analyzer with an external device such as a computer.

10833A GPIB cable	1.0 m (3.3 ft)
10833B GPIB cable	2.0 m (6.6 ft)
10833C GPIB cable	3.0 m (9.9 ft)
10833D GPIB cable	0.5 m (1.6 ft)

82357A USB/GPIB Interface

The 82357A can be used to connect the E5070B/E5071B with an external device controlled by the E5070B/E5071B.

18

Information on Maintenance

This chapter explains the measures you should take to maintain the Agilent E5070B/E5071B.

Backing Up the Data

Be sure to back up regularly your important data (including program) files in this instrument to a CD-R or other backup medium. Agilent Technologies shall not be liable for any data damages caused by troubles of this instrument.

Making Backup Files

Making backup files on a floppy disk

You can make backup files on a floppy disk using the copy function. See “Organizing Files and Folders” on page 367 for making a copy.

Making backup files on the hard disk of an external PC

You can make backup files on the hard disk of an external PC using following methods.

- You can access to drive D: of the E5070B/E5071B from an external PC via LAN, and copy your important data files on the drive D: to the external PC. See “Accessing Hard Disk of E5070B/E5071B from External PC” on page 440 for details.
- You can transfer your important data files on the drive D: of the E5070B/E5071B to the external PC using :MMEM:TRAN command via GPIB. See *Programmer's Guide* for details.

NOTE

Do not modify any files and folders in drives other than drive A: and drive D:. Doing so will cause malfunctions.

Removing/Mounting Removable Hard Disk

This section provides information on how to mount and remove a removable hard disk as well as write the system correction data. Whether a hard disk is removable can be ascertained by referring to the serial number. For further information, see “Change 9” on page 600 in the “Manual Changes.”

CAUTION

For calibration or repair of the E5070B/E5071B, send it with the removable hard disk mounted.

If you replace the removable hard disk, make sure to retrieve the system correction data from the backup memory. For detailed procedures, refer to “Writing System Correction Data from Backup Memory to Removable Hard Disk” on page 579.

If you require a backup removable hard disk, we recommend that you purchase the E5070U/E5071U-Opt018 hard disk drive.

Removing Removable Hard Disk

Follow the steps below to remove a removable hard disk.

CAUTION

Before removing a hard disk, you *must* turn off the unit’s power and then disconnect the power cord from the outlet.

- Step 1.** Unscrew the four screws that hold the cover panel (1 in Figure 18-1, P/N 0515-2146).
- Step 2.** Remove the panel.
- Step 3.** Unscrew the four screws that hold the removable hard disk (1 in Figure 18-2, P/N0515-0374).
- Step 4.** Carefully remove the flat cable (2 in Figure 18-2, P/N E5070-61638.*¹) from the removable hard disk. Release the cable’s connector by pressing the locking hooks at the sides of the connector.

Mounting Removable Hard Disk

Follow the steps below to mount a removable hard disk.

- Step 1.** Connect the removable hard disk to the flat cable's connector (2 in Figure 18-2).
- Step 2.** Secure the removable hard disk in place with the four screws (1 in Figure 18-2).
- Step 3.** Secure the cover panel in place with the four screws (1 in Figure 18-1).

*1. Flat cable with connector outfitted

Figure 18-1 Mounting/Removing Removable Hard Disk -1

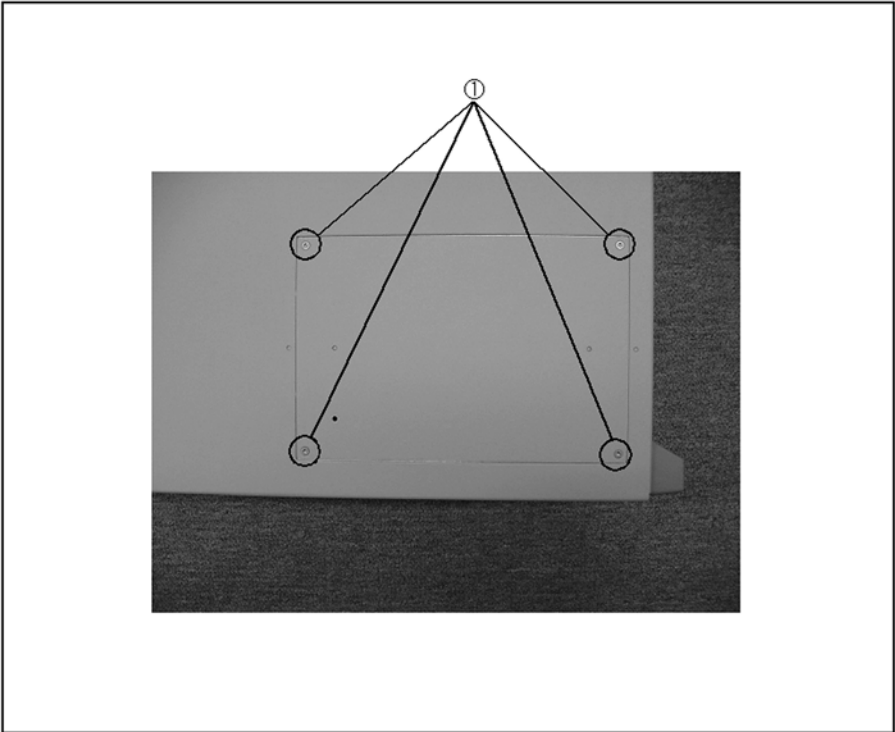

e5070by7016

Figure 18-2 Mounting/Removing Removable Hard Disk -2

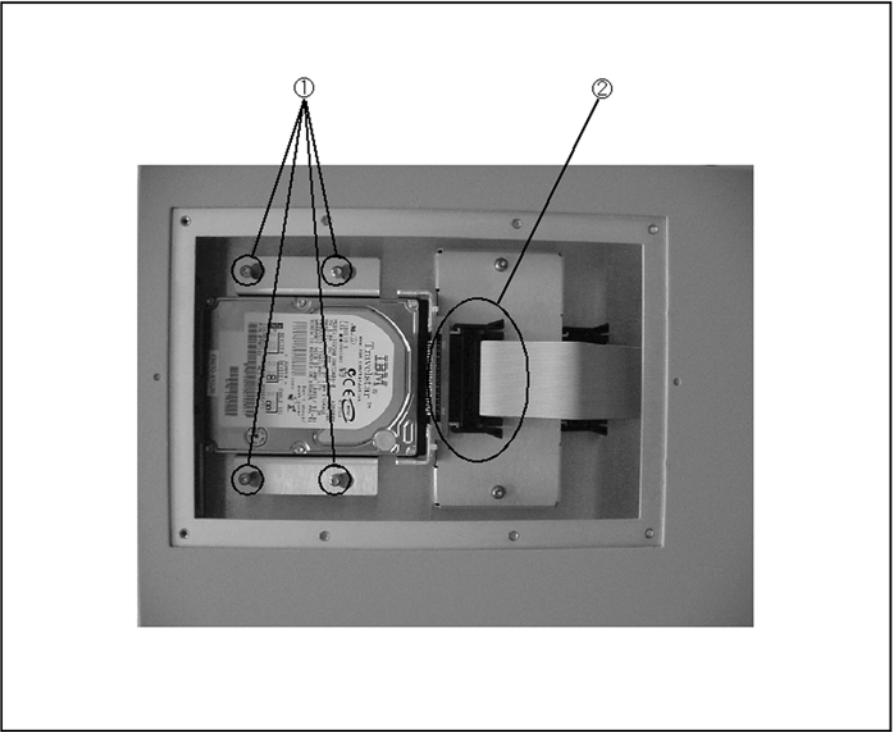

e5070by7015

Writing System Correction Data from Backup Memory to Removable Hard Disk

The following procedure shows how to write the system correction data stored in the backup memory to the newly mounted removable hard disk.

- Step 1.** Turn on the E5070B/E5071B.
- Step 2.** Press **Macro Setup** .
- Step 3.** Press **Load Project...** in the softkey menu.
- Step 4.** A dialog box appears for you to select the program to be loaded. Select `RestoreSysCorFile.vba` from the `D:\Agilent\Service` folder and then press the **Open** button.
- Step 5.** Press **Macro Run** .
- Step 6.** The `RestoreSysCorFile` dialog box appears (Figure 18-3). Click **OK**.

Figure 18-3 RestoreSysCorFile Dialog Box



CAUTION

Once the program has terminated, restart the E5070B/E5071B to enable the system correction data.

Cleaning this Instrument

This section describes how to clean the instrument.

WARNING

To protect yourself from electrical shock, be sure to unplug the power cable from the outlet before cleaning the instrument.

Never clean the internal components of the instrument.

Cleaning an LCD

Use one of the following methods to clean the display surface regularly.

- For normal cleaning, rub the surface gently with a dry, soft cloth.
- When stains are difficult to remove, gently wipe the surface with cloth dampened with a small amount of ethanol or isopropyl alcohol.
You can clean the standard type LCD (no touch screen function) with a cloth dipped in water and then wrung tightly.

NOTE

Do not use chemicals other than ethanol and isopropyl alcohol to wet the cleaning cloth.

To clean a touch screen type LCD (Option 016), do not wet the cloth with water.

Maintenance of Test Ports and Other Connectors/Ports

Test ports on the front panel of the E5070B/E5071B are fitted with N Type connectors (f). Stains or other damage to these connectors would significantly affect the accuracy in measurements in the RF range. Always pay attention to the following precautions.

- Always keep the connectors free from stains and dust.
- Do not touch the contact surface on the connectors.
- Do not plug damaged or scratched connectors into the test ports.
- Use compressed air for cleaning connectors. Do not use abrasives under any circumstance.

The above precautions must also be observed in maintaining connectors and ports other than these test ports.

Cleaning a Display Other than an LCD

To remove stains on parts other than the LCD, test ports, and other connectors/ports of the instrument, wipe them gently with a soft cloth that is dry or wetted with a small amount of water and wrung tightly.

Replacement of Parts with Limited Service Life

This instrument incorporates parts with limited service life as shown in Table 18-1. Using the recommended replacement time shown in Table 18-1 as a guide, request the Company's Service Center to replace these parts. However, a part may need to be replaced at an earlier time than that listed in the table, depending on such conditions as location, frequency of use, and where it is stored.

NOTE

Each service life and recommended replacement time listed below is for reference only and does not imply a guarantee of the part's service life.

Table 18-1

Parts with Limited Service Life

Part Name	Service Life (Parts supplier reference value)	Recommended replacement time
Hard Disk Drive* ¹	5 years or 20,000 operating hours, whichever comes earlier	3 years
Floppy disk drive* ²	5 years or 30,000 operating hours, whichever comes earlier	4 years
Main fan* ²	50,000 operating hours	5 years
CPU fan* ²	50,000 operating hours	5 years
Power supply* ²	50,000 operating hours (Depends on the service life of the power supply cooling fan)	5 years
LCD screen backlight* ³	50,000 operating hours	5 years
Touch screen (function)	One million times (dotting life)	5 years

*1. Exchanging hard disk drives causes the contents written after shipment from the factory (LAN setup, etc.) to be initialized to the state at the time of shipment. The programs and data stored in Drive D (user directory) are erased.

*2. The service life may be significantly shorter when used in a dusty and dirty environment.

*3. When the unit is used for automatic measurements in a production line and the on-screen information is not required, the life of the LCD backlight can be saved by turning it off. As for the method of turning the backlight off, refer to "Turning off the LCD Screen Backlight" on page 446.

Cautions Applicable to Requesting Repair, Replacement, Regular Calibration, etc.

Backing Up Data in the Hard Disk

The user is requested to back up the stored programs and data into external media by using the instrument's storing function before requesting the Company's Service Center to repair the instrument or replace hard disks.

See "Making Backup Files" on page 576 for how to make backup files.

Please take note that the Company will not be held liable to any extent for potential erasure or change of stored programs or data due to the repair or replacement of hard disks performed by the Company. When a hard disk itself fails, the programs and data stored in it cannot be recovered.

Devices to be Sent Back for Repair or Regular Calibration

If it is necessary to send the unit to the Service Center of Agilent Technologies for repair or regular calibration, please follow the instructions below.

Equipment to be Sent

When requesting repair or regular calibration of the unit by our Service Center, send only the E5070B/E5071B main unit without any installed option you may have ordered. Unless specifically instructed, it is not necessary to send accessories and calibration kits.

Packing

Use the original package and shock absorbers, or equivalent antistatic packing materials, when sending the unit.

Shipping Address

For the location of the nearest Agilent Technologies Service Center, contact the Customer Contact listed at the end of this brochure.

Recommended Calibration Period

The recommended calibration period for this instrument is one year. The user is recommended to request the Company's Service Center to perform regular calibration every year.

A **Manual Changes**

This appendix contains the information required to adapt this manual to versions or configurations of the E5070B/E5071B manufactured earlier than the current printing date of this manual. The information in this manual applies directly to E5070B/E5071B units having the serial number printed on the title page of this manual.

Manual Changes

To adapt this manual to your E5070B/E5071B, refer to Table A-1, and Table A-2.

Table A-1 Manual Changes by Serial Number

Serial Prefix or Number	Make Manual Changes
MY42100211 (E5070B), MY42100407 (E5071B)	Change 2
MY421, JP1KK	Change 5
MY422	Change 6
MY423	Change 9

Table A-2 Manual Changes by Firmware Version

Version	Make Manual Changes
A.03.0x	Change 1
A.03.53	Change 3
A.03.54	Change 4
A.03.62	Change 7
A.04.00	Change 8
A.05.00	Change 10
A.06.00	Change 11, 12, 13
A.06.50	Change 14

The ten-character serial number is stamped on the serial number plate (Figure A-1) on the rear panel.

Figure A-1 Example of Serial Number Plate

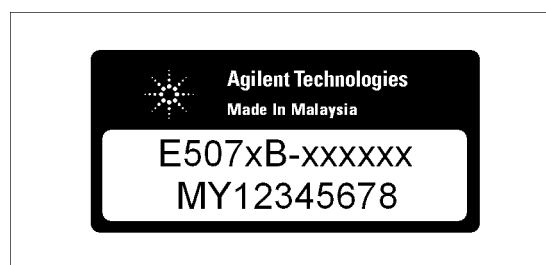

e5070buj7013

Change 14

The firmware revision A.06.50 or lower does not support the following functions. Please delete the descriptions about these functions from this manual.

- o Equation editor function
- o User definition variable function
- o Function to trigger only the active channel
- o Change of the dialog box for checking the product information
- o Calibration kits, 85038A/F/M, have been added
- o Available power meters, N1911A/N1912A, have been added.
- o Function to remove/insert adapter characteristics.
- o Unknown Thru Calibration function

Change 13

The firmware revision A.06.00 or lower does not support the following functions. Please delete the descriptions about these functions from this manual.

- o Low latency external trigger function
- o Averaging trigger function
- o Function of tolerance setting at power calibration
- o Function of trigger source setting at calibration
- o Function of data saving in touchstone format by using front panel
- o Function of simplified full 3/4 port calibration by using front panel
- o Simplified 3/4 port TRL calibration function
- o Partial overwrite function

Change 12

For the TRL/LRM calibration with the firmware version A.06.00 or lower, follow the steps below.

Performing TRL/LRM Calibration

Use the following VBA macro to perform the TRL/LRM calibration.

Folder	VBA macro name (project name)
D:\Agilent	TRL_LRM_cal.vba

This VBA macro lets you perform 2-/3-/4-port TRL/LRM calibration for any selected port.

TRL/LRM calibration provides a level of accuracy equivalent to full 2-/3-/4-port calibration using short, open, thru (SLOT) standards.

To perform TRL calibration, you need to prepare thru, reflection (open or short), and line standards. The thru and line must have the same reference impedance Z_0 and transfer

Manual Changes

Manual Changes

constant (i.e., be the same material). In the case of LRM calibration, you need to prepare a match instead of a line standard.

NOTE Do NOT delete this VBA macro. This VBA macro cannot be recovered even performing the system recovery once deleted.

NOTE You can perform LRL calibration using a line standard instead of the thru standard because this VBA macro lets you define an arbitrary value as the delay of the thru standard. To perform LRL calibration, define the delay value of the line at the thru definition and then measure the thru calibration data by using the line standard.

Note on Use

Set the power level to -10 dBm or less in order to accurately measure a DUT close to the open or short state.

Operating Procedure

1. Setting stimulus conditions

Set the stimulus conditions of the channel for which you perform the calibration.

For information on the setting procedure, see Chapter 3, “Setting Measurement Conditions.”

2. Setting VBA macro

Load the VBA project for the TRL/LRM calibration and run it.

Step 1. Press .

Step 2. Press **Load & Run**.

Step 3. Press **TRL_LRM_cal** to start the macro.

Step 4. When the message shown in Figure A-2 appears, press **OK** to turn off the system error correction.

Figure A-2 Turning off system error correction

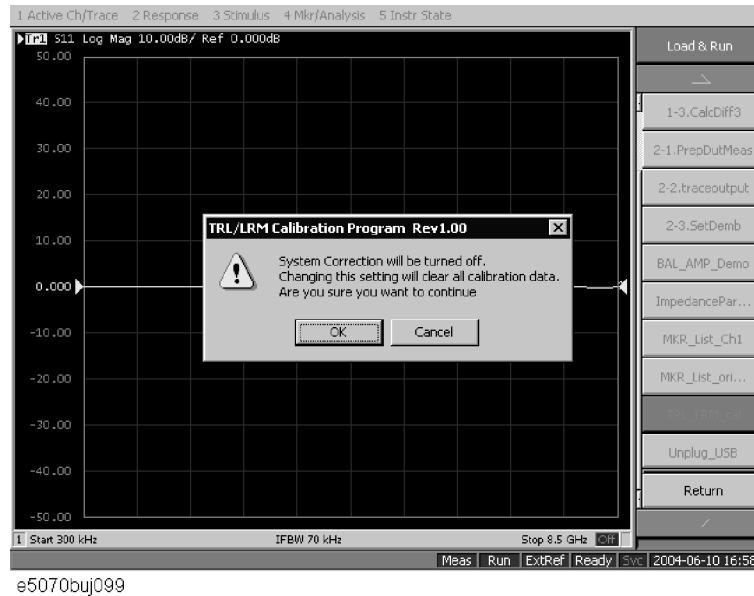

NOTE The System Correction Off button does not appear when system error correction has already been turned off.

2-port TRL/LRM calibration operating procedure

1. Selecting Test Port

Select test ports (1 in Figure A-3).

NOTE For more information on starting VBA macro, see “Operating Procedure” on page 586

Figure A-3 TRL/LRM main control panel



NOTE The TRL/LRM calibration VBA macro automatically detects the ENA’s active channel, and calibration is performed for the active channel.

2. Defining Calibration Kit

Define the calibration kit you use.

- Step 1.** Press the **Define Cal kit** button (2 in Figure A-3) to bring up the calibration kit definition screen shown in Figure A-4.

Figure A-4

Calibration kit definition screen

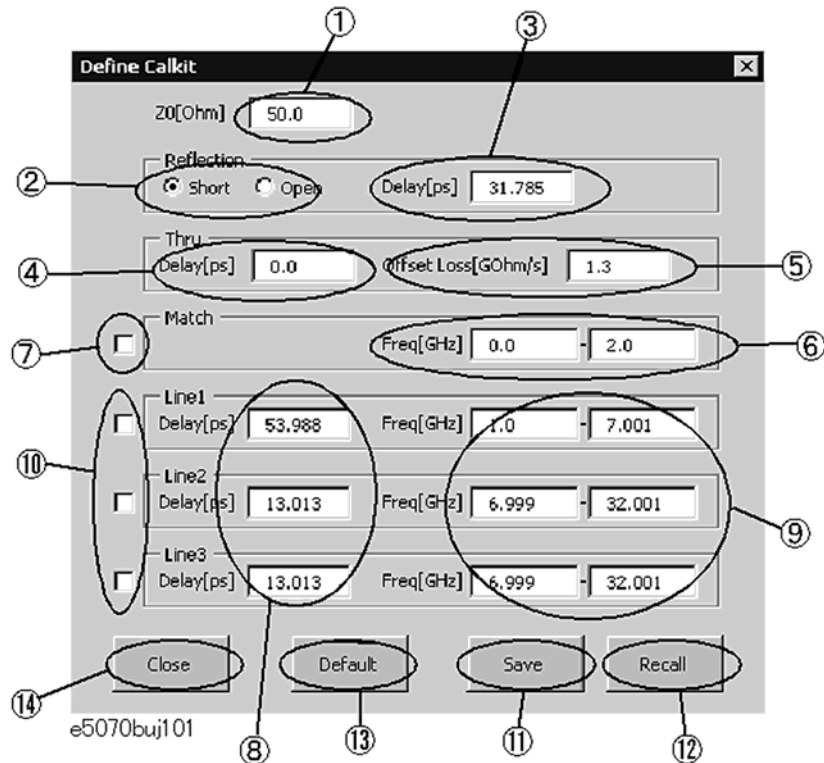

Step 2. Define each standard as follows

Reference impedance (Z0)

Enter a value of the reference impedance of thru, line and match (1 in Figure A-4).

Reflection

Select a standard type (2 in Figure A-4) and enter a delay value (3 in Figure A-4) in ps.

Thru

Enter a delay value (4 in Figure A-4) in ps. If necessary, also enter its offset loss value (5 in Figure A-4) in Gohm/sec.

Match

Enter a frequency range (6 in Figure A-4) in GHz. Check the match you use for calibration (7 in Figure A-4).

Line

You can define 3 lines: Line 1, Line 2, and Line 3.

Enter a delay value (8 in Figure A-4) in ps and enter a frequency range (9 in Figure A-4) in GHz.

Check the lines you use for calibration (7 in Figure A-4).

-
- NOTE** When you define each calibration standard, the following points should be considered.
- Reference impedance Z_0 must be set to the same value as the ENA's system impedance Z_0 value.
 - When you use Line 1, Line 2, and Line 3, their defined frequency ranges must overlap by at least 10 kHz.
-

Saving and loading calibration kit definitions

Press the **Save** button (11 in Figure A-4) to save the definition of the current calibration kit to a file. Press the **Recall** button (12 in Figure A-4) to recall the definition of a calibration kit from a previously saved file.

-
- NOTE** If you save as “D:\Agilent\Data\TRL_LRM_cal\Default.dat,” the file is handled as the default definition file. The default definition file is automatically recalled when the macro starts.
-

- NOTE** The factory-shipped default definition file has the same content as “D:\Agilent\Trldata\SysDefault.dat.” Copy “D:\Agilent\Trldata\SysDefault.dat” to the default definition file in order to restore the default definition file to its factory-shipped condition.

Do not change “D:\Agilent\Trldata\SysDefault.dat.”

Initializing calibration kit definition

Press the **default** button (13 in Figure A-4) to recall the definition of a calibration kit from the default definition file (“D:\Agilent\Data\TRL_LRM_cal\Default.dat”).

- Step 3.** Press the **Close** button (14 in Figure A-4) to finish defining the calibration kit.

3. Performing Calibration

Measure necessary calibration data and enable error correction.

-
- NOTE** The definition of the frequency range of the line standard and match standard used for measurement must cover the sweep range of the channel for which you perform calibration.
- If the **Thru**, **Reflection**, **Match**, and **Line** keys do not appear, go back to the calibration kit definition menu and confirm that the frequency range definitions of match and lines are correctly entered to cover the ENA's measurement frequency range.
-

- Step 1.** Measure calibration data.

In this example, 2-port TRL/LRM calibration between test ports 1 and 2 (1 in Figure A-5) is performed by using the Match, Line 1, and Line 2 standards.

Figure A-5 Performing 2-port TRL/LRM calibration

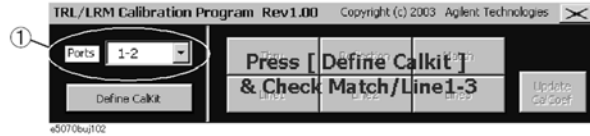

Step 2. Press the **Thru** button (1 in Figure A-6).

Step 3. Make the through condition for test ports 1 and 2 and press the [**Thru 1-2** button (2 in Figure A-6). The through measurement is performed, and an asterisk appears at the [**Thru 1-2** button and then a check mark [v] also appears on the **Thru** button.

Figure A-6 Example of performing 2-port TRL/LRM calibration

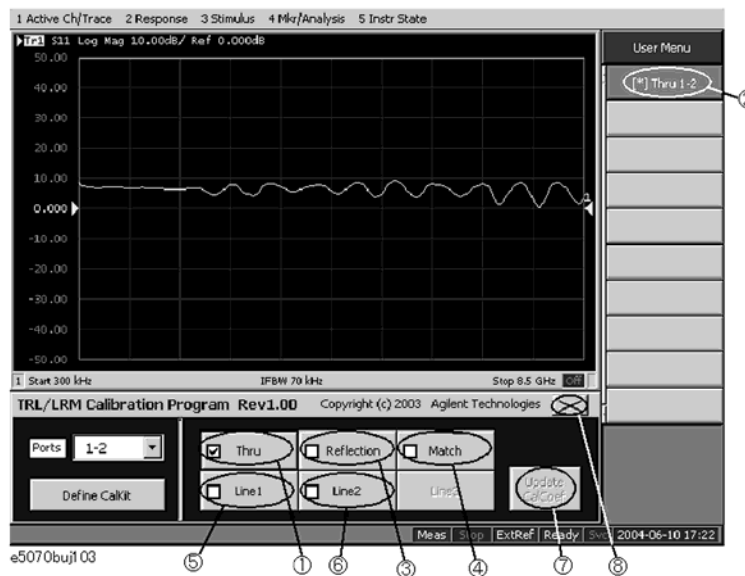

Step 4. Press the **Reflection** button (3 in Figure A-6).

Step 5. Connect the Reflection standard to test port 1 and press the [**Reflection1** button. The reflection measurement is performed, and an asterisk appears at the [**Reflection1** button.

Step 6. Connect the Reflection standard to test port 2 and press the [**Reflection2** button. The reflection measurement is performed, and an asterisk appears at the [**Reflection2** button and then a check mark [v] also appears on the **Reflection** button.

Step 7. Press the **Match** button (4 in Figure A-6).

Step 8. Connect the Match standard to test port 1 and press the [**Match1** button. The match measurement is performed, and an asterisk appears at the [**Match1** button.

Step 9. Connect the Match standard to test port 2 and press the [**Match2** button. The reflection measurement is performed, and an asterisk appears at the [**Match2** button and then a check mark [v] also appears on the **Match** button.

Step 10. Press the **Line1** button (5 in Figure A-6).

Step 11. Connect the Line 1 standard between test ports 1 and 2 and press the [**Line1 1-2** button.

The line measurement is performed, and an asterisk appears at the []Line1 1-2 button and then a check mark [v] also appears on the **Line1** button.

Step 12. Press the **Line2** button (6 in Figure A-6).

Step 13. Connect the Line 2 standard between test ports 1 and 2 and press the []Line2 1-2 button. The line measurement is performed, and an asterisk appears at the []Line2 1-2 button and then a check mark [v] also appears on the **Line2** button.

NOTE When the frequency ranges of the line and the match overlap, the data of the line is used in the overlapped frequency area. When the frequency ranges of multiple lines overlap, the data of the line measured later is used in the overlapped frequency areas.

NOTE Isolation calibration measurement is not available.

Step 14. When all of the necessary calibration measurements are completed, press the **Update Cal Coef** button (7 in Figure A-6). The calibration coefficient is calculated and the error correction is turned ON. In the calibration property display (ON/OFF with [Cal] - **Property**), the state is indicated by “F” (same as full n-port SOLT calibration).

4. Closing macro

Press the **X** button (8 in Figure A-6) to exit from the macro.

Multiport TRL/LRM calibration operating procedure

1. Selecting Test Port Select test ports (1 in Figure A-7). As shown in Figure A-7, 3- and 4-port TRL/LRM calibration can be performed with any combination of test ports.

NOTE For more information on starting a VBA macro, see “Operating Procedure” on page 586.

Figure A-7 Selecting test port

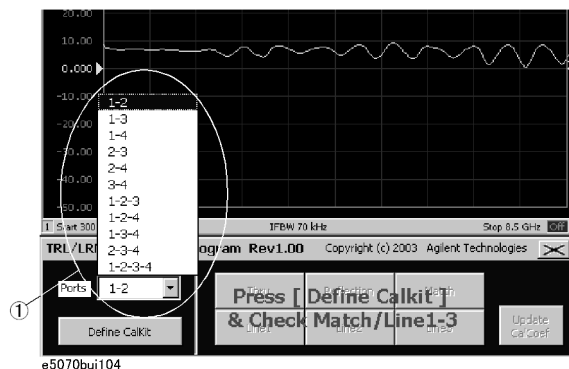

NOTE The TRL/LRM calibration VBA macro automatically detects the ENA's active channel, and calibration is performed for the active channel. The macro does not perform calibration for the ENA's inactive channels.

2. Defining Calibration Kit

Manual Changes

Manual Changes

For more information on defining a calibration kit, see ??.

3. Performing Calibration

Measure the necessary calibration data and enable error correction.

NOTE

The definition of the frequency range of the line standard and match standard used for measurement must cover the sweep range of the channel for which you perform calibration.

If the **Thru**, **Reflection**, **Match**, and **Line** keys do not appear, go back to the calibration kit definition menu and confirm that the frequency range definitions of match and lines are correctly entered to cover the ENA's measurement frequency range.

NOTE

In multiport TRL/LRM calibration, the through and line calibration measurements are not performed for all of the paths among the test ports. The following table shows the measured paths of the through and line calibration measurements. The through and line calibration data of non-measured paths are mathematically derived from the through and line calibration data of the measured paths.

Calibration Type	Measurement ports of Reflection and Match cal.	Measurement paths of Thru and Line cal.
3-port TRL/LRM cal. for Ports: 1-2-3	All ports (1, 2, and 3)	1-2 and 1-3
3-port TRL/LRM cal. for Ports: 1-2-4	All ports (1, 2, and 4)	1-2 and 1-4
3-port TRL/LRM cal. for Ports: 1-3-4	All ports (1, 3, and 4)	1-3 and 3-4
3-port TRL/LRM cal. for Ports: 2-3-4	All ports (2, 3, and 4)	2-3 and 3-4
4-port TRL/LRM cal. for Ports: 1-2-3-4	All ports (1, 2, 3, and 4)	1-2, 1-3, and 3-4

Step 1. Measure calibration data.

In this example, 3-port TRL/LRM calibration for test ports 1, 2, and 3 (1 in Figure A-8) is performed by using the Match, Line 1, and Line 2 standards.

Figure A-8

Performing multipoint TRL/LRM calibration

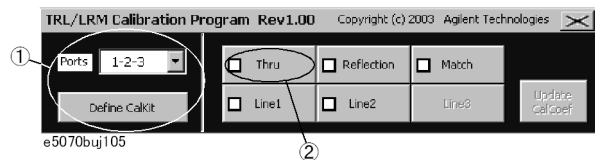

Step 2. Press the **Thru** button (2 in Figure A-8).

Step 3. Make the through condition for test ports 1 and 2 and press the []Thru 1-2 button (1 in Figure A-9). The through measurement is performed, and an asterisk appears at the []Thru 1-2 button.

Step 4. Make the through condition for test ports 1 and 3, and press the []Thru 1-3 button (2 in Figure A-9). The through measurement is performed, and an asterisk appears at the []Thru 1-3 button and then a check mark [v] (3 in Figure A-9) also appears on the **Thru** button.

Figure A-9

Example of performing multiport TRL/LRM calibration

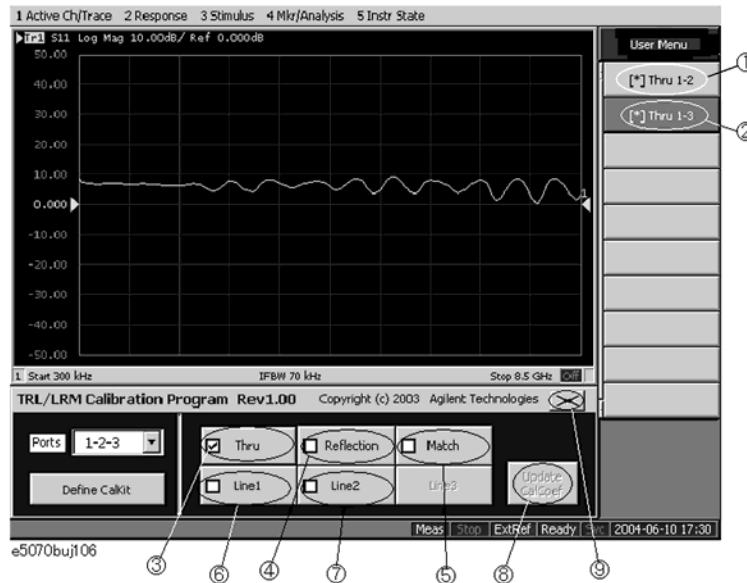

- Step 5.** Press the **Reflection** button (4 in Figure A-9).
- Step 6.** Connect the Reflection standard to test port 1 and press the []**Reflection1** button. The reflection measurement is performed, and an asterisk appears at the []**Reflection1** button.
- Step 7.** Connect the Reflection standard to test port 2 and press the []**Reflection2** button. The reflection measurement is performed, and an asterisk appears at the []**Reflection2** button.
- Step 8.** Connect the Reflection standard to test port 3 and press the []**Reflection3** button. The reflection measurement is performed, and an asterisk appears at the []**Reflection3** button and then a check mark [v] also appears on the **Reflection** button.
- Step 9.** Press the **Match** button (5 in Figure A-9).
- Step 10.** Connect the Match standard to test port 1 and press the []**Match1** button. The match measurement is performed, and an asterisk appears at the []**Match1** button.
- Step 11.** Connect the Match standard to test port 2 and press the []**Match2** button. The match measurement is performed, and an asterisk appears at the []**Match2** button.
- Step 12.** Connect the Match standard to test port 3 and press the []**Match3** button. The match measurement is performed, and an asterisk appears at the []**Match3** button and then a check mark [v] also appears on the **Match** button.
- Step 13.** Press the **Line1** button (6 in Figure A-9).
- Step 14.** Connect the Line 1 standard between test ports 1 and 2 and press the []**Line1 1-2** button. The line measurement is performed, and an asterisk appears at the []**Line1 1-2** button.
- Step 15.** Connect the Line 1 standard between test ports 1 and 3 and press the []**Line1 1-3** button. The line measurement is performed, and an asterisk appears at the []**Line1 1-3** button and then a check mark [v] also appears on the **Line1** button.
- Step 16.** Press the **Line2** button (7 in Figure A-9).
- Step 17.** Connect the Line 2 standard between test ports 1 and 2, and press the []**Line2 1-2** button.

The line measurement is performed, and an asterisk appears at the []Line2 1-2 button.

- Step 18.** Connect the Line 2 standard between test ports 1 and 3 and press the []Line2 1-3 button. The line measurement is performed, and an asterisk appears at the []Line2 1-3 button and then a check mark [v] also appears on the **Line2** button.

NOTE When the frequency ranges of the line and the match overlap, the data of the line is used in the overlapped frequency area. When the frequency ranges of multiple lines overlap, the data of the line measured later is used in the overlapped frequency areas.

NOTE Isolation calibration measurement is not available.

- Step 19.** When all of the necessary calibration measurements are completed, press the **Update Cal Coef** button (8 in Figure A-9). The calibration coefficient is calculated and the error correction is turned ON. In the calibration property display (ON/OFF with [Cal] - **Property**), the state is indicated by “F” (same as full n-port SOLT calibration).

4. Closing macro Press the **X** button (9 in Figure A-9) to exit from the macro.

Change11

With the firmware version A.06.00 or lower, follow the steps below to save measurement data into a file in Touchstone format.

Saving data in Touchstone format

Use the following VBA macro to save measurement data into a file in Touchstone format.

Folder	VBA macro name (project name)
D:\Agilent	SaveToTouchstone.vba

NOTE Don't delete this VBA macro. This VBA macro cannot be restored by executing system recovery.

This VBA macro saves measurement data of any channel into a Touchstone format file, based on 1- to 4-port models.

NOTE You can save data in “real number - imaginary number”, “dB - angle” or “amplitude - angle.”

You can use data saved in Touchstone format for a circuit simulator such as Agilent Advanced Design System (ADS) on your PC (personal computer) or workstation. For more information on the ADS, refer to the operation manual that comes with the system.

NOTE You cannot recall data saved in Touchstone format on the E5070B/E5071B.

For information on data structure in a saved file, refer to “Data structure in Touchstone file” on page 597.

Manual Changes
Manual Changes

Note on use

When the fixture simulator is ON and the port impedance conversion is ON, Z0 of all ports to be saved must be set to the same value.

Operating Procedure

1. Starting VBA macro

- Step 1.** Press **[Macro Setup]**.
- Step 2.** Press **Load Project**.
- Step 3.** The Open dialog box appears. Specify the file name “D:\Agilent\SaveToTouchstone.vba” and press the **Open** button.
- Step 4.** Press **[Macro Run]** to start the macro. (Refer to Figure A-10.)

Figure A-10

SaveToTouchstone dialog box

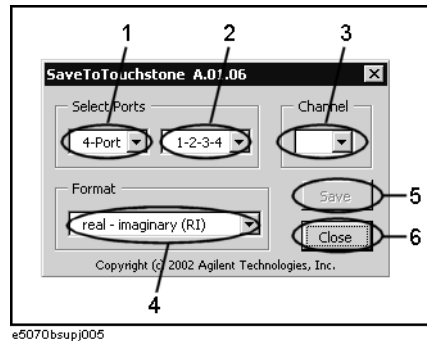

2. Saving data

- Step 1.** Select the number of ports (1 in Figure A-10) and test ports (2 in Figure A-10).

NOTE You can select 1 port or 2 ports as the number of ports when the maximum number of channels/traces is 16 channels/4 traces or 12 channels/6 traces.

- Step 2.** Select a channel (3 in Figure A-10).

NOTE The channel selected in this step has no relation to the active channel.

- Step 3.** Select the data saving format (4 in Figure A-10).

real - imaginary (RI)	real and imaginary parts
magnitude - angle (MA)	linear magnitude and phase (degree)
dB - angle (DB)	logarithmic magnitude (dB) and phase (degree)

- Step 4.** Press the **Save** button (5 in Figure A-10). Measurement of necessary data for the selected channel in Step 2 starts.

NOTE Regardless of the state of the trigger system, measurement is automatically performed

once.

NOTE

Regardless of the on/off state of the balance-unbalance conversion, measurement is performed without the balance-unbalance conversion.

- Step 5.** When the measurement is complete, the Save As dialog box appears. Specify a file name and press the **Save** button.
- Step 6.** When saving to the file is complete, the start screen appears again.

3. Closing VBA macro

- Step 1.** Press the **Close** button (6 in Figure A-10) to exit from the macro.

Data structure in Touchstone file

Figure A-11 through Figure A-14 show the data structure of a file saved in Touchstone format. The content of the file is text data, which is ready to be read with a general text editor.

Figure A-11 One-port Touchstone file

The diagram shows a Touchstone file structure. It is divided into two main sections: **Option** and **Data**.

Option section: A single line containing the text "# Hz S FMT R Z0".

Data section: A series of lines representing measurement data. Each line starts with a frequency value (e.g., "Freq (1)", "Freq (2)", ..., "Freq (N)"), followed by a tab character, a parameter name (e.g., "Saa.pri (1)", "Saa.pri (2)", ..., "Saa.pri (N)"), another tab character, and a parameter value (e.g., "Saa.sec (1)", "Saa.sec (2)", ..., "Saa.sec (N)"). Each line ends with a line break character.

Legend:

- FMT : data saving format
- RI = real and imaginary parts
- MA = linear magnitude and phase (degree)
- DB = logarithmic magnitude (dB) and phase (degree)
- Z0 : Reference impedance
- a : Selected test port number
- Freq(n) : Frequency at measurement point n [Hz]
- Saa.pri(n) : Real part(RI), linear magnitude(MA) or dB(DB) of measured parameter Saa at measurement point n
- Saa.sec(n) : Imaginary part(RI) or phase(MA,DB) of measured parameter Saa at measurement point n
- N : Number of measurement points
- Tab: Tab
- ↵: Line break

e5070bsupe001

A. Manual Changes

Manual Changes Manual Changes

Figure A-12 Two-port Touchstone file

Hz S FMT R Z0 Option

Freq (1) Saa. pri (1) Saa. sec (1) Sba. pri (1) Sba. sec (1) Sab. pri (1) Sab. sec (1) Sbb. pri (1) Sbb. sec (1)

Freq (2) Saa. pri (2) Saa. sec (2) Sba. pri (2) Sba. sec (2) Sab. pri (2) Sab. sec (2) Sbb. pri (2) Sbb. sec (2)

⋮

Freq (N) Saa. pri (N) Saa. sec (N) Sba. pri (N) Sba. sec (N) Sab. pri (N) Sab. sec (N) Sbb. pri (N) Sbb. sec (N)

Data FMT : data saving format

RI = real and imaginary parts

MA = linear magnitude and phase (degree)

DB = logarithmic magnitude (dB) and phase (degree)

Z0 : Reference impedance

a - b : Selected test port number (corresponding in ascending order, beginning with 1 to a)

Freq(n) : Frequency at measurement point n [Hz]

Sxy. pri(n) : Real part(RI), linear magnitude(MA) or dB(DB) of measured parameter Sxy at measurement point n

Sxy. sec(n) : Imaginary part(RI) or phase(MA,DB) of measured parameter Sxy at measurement point n

N : Number of measurement points

: Tab

: Line break

e5070bsupe002

Figure A-13 Three-port Touchstone file

Option オプション # Hz S FMT R Z0

Data データ

Freq (1) Saa. pri (1) Saa. sec (1) Sab. pri (1) Sab. sec (1) Sca. pri (1) Sca. sec (1)

Sba. pri (1) Sba. sec (1) Sbb. pri (1) Sbb. sec (1) Sbc. pri (1) Sbc. sec (1)

Sca. pri (1) Sca. sec (1) Scb. pri (1) Scb. sec (1) Scc. pri (1) Scc. sec (1)

Freq (2) Saa. pri (2) Saa. sec (2) Sab. pri (2) Sab. sec (2) Sca. pri (2) Sca. sec (2)

Sba. pri (2) Sba. sec (2) Sbb. pri (2) Sbb. sec (2) Sbc. pri (2) Sbc. sec (2)

Sca. pri (2) Sca. sec (2) Scb. pri (2) Scb. sec (2) Scc. pri (2) Scc. sec (2)

⋮

Freq (N) Saa. pri (N) Saa. sec (N) Sab. pri (N) Sab. sec (N) Sca. pri (N) Sca. sec (N)

Sba. pri (N) Sba. sec (N) Sbb. pri (N) Sbb. sec (N) Sbc. pri (N) Sbc. sec (N)

Sca. pri (N) Sca. sec (N) Scb. pri (N) Scb. sec (N) Scc. pri (N) Scc. sec (N)

FMT : data saving format

RI = real and imaginary parts

MA = linear magnitude and phase (degree)

DB = logarithmic magnitude (dB) and phase (degree)

Z0 : Reference impedance

a - c : Selected test port number (corresponding in ascending order, beginning with 1 to a)

Freq(n) : Frequency at measurement point n [Hz]

Sxy. pri(n) : Real part(RI), linear magnitude(MA) or dB(DB) of measured parameter Sxy at measurement point n

Sxy. sec(n) : Imaginary part(RI) or phase(MA,DB) of measured parameter Sxy at measurement point n

N : Number of measurement points

: Tab

: Line break

e5070bsupe003

Figure A-14 Four-port Touchstone file

Hz S FMT R Z0 Option

Freq (1)	Tab	S11	pri (1)	Tab	S11	sec (1)	Tab	S12	pri (1)	Tab	S12	sec (1)	Tab	S13	pri (1)	Tab	S13	sec (1)	Tab	S14	pri (1)	Tab	S14	sec (1)			
Tab	Tab	Tab		Tab	Tab		Tab	Tab		Tab	Tab		Tab	Tab		Tab	Tab		Tab	Tab		Tab	Tab		↙		
Tab	Tab	Tab		Tab	Tab		Tab	Tab		Tab	Tab		Tab	Tab		Tab	Tab		Tab	Tab		Tab	Tab		↙		
Tab	Tab	Tab		Tab	Tab		Tab	Tab		Tab	Tab		Tab	Tab		Tab	Tab		Tab	Tab		Tab	Tab		↙		
Tab	Tab	Tab		Tab	Tab		Tab	Tab		Tab	Tab		Tab	Tab		Tab	Tab		Tab	Tab		Tab	Tab		↙		
Freq (2)	Tab	S11	pri (2)	Tab	S11	sec (2)	Tab	S12	pri (2)	Tab	S12	sec (2)	Tab	S13	pri (2)	Tab	S13	sec (2)	Tab	S14	pri (2)	Tab	S14	sec (2)	↙		
Tab	Tab	Tab		Tab	Tab		Tab	Tab		Tab	Tab		Tab	Tab		Tab	Tab		Tab	Tab		Tab	Tab		↙		
Tab	Tab	Tab		Tab	Tab		Tab	Tab		Tab	Tab		Tab	Tab		Tab	Tab		Tab	Tab		Tab	Tab		↙		
Tab	Tab	Tab		Tab	Tab		Tab	Tab		Tab	Tab		Tab	Tab		Tab	Tab		Tab	Tab		Tab	Tab		↙		
Tab	Tab	Tab		Tab	Tab		Tab	Tab		Tab	Tab		Tab	Tab		Tab	Tab		Tab	Tab		Tab	Tab		↙		
Tab	Tab	Tab		Tab	Tab		Tab	Tab		Tab	Tab		Tab	Tab		Tab	Tab		Tab	Tab		Tab	Tab		↙		
⋮																											
Freq (N)	Tab	S11	pri (N)	Tab	S11	sec (N)	Tab	S12	pri (N)	Tab	S12	sec (N)	Tab	S13	pri (N)	Tab	S13	sec (N)	Tab	S14	pri (N)	Tab	S14	sec (N)	↙		
Tab	Tab	Tab		Tab	Tab		Tab	Tab		Tab	Tab		Tab	Tab		Tab	Tab		Tab	Tab		Tab	Tab		↙		
Tab	Tab	Tab		Tab	Tab		Tab	Tab		Tab	Tab		Tab	Tab		Tab	Tab		Tab	Tab		Tab	Tab		↙		
Tab	Tab	Tab		Tab	Tab		Tab	Tab		Tab	Tab		Tab	Tab		Tab	Tab		Tab	Tab		Tab	Tab		↙		

Data

FMT : data saving format
 RI = real and imaginary parts
 MA = linear magnitude and phase (degree)
 DB = logarithmic magnitude (dB) and phase (degree)
 Z0 : Reference impedance

Freq(n) : Frequency at measurement point n [Hz]
 Sxy.pri(n) : Real part(RI), linear magnitude(MA) or dB(DB) of measured parameter Sxy at measurement point n
 Sxy.sec(n) : Imaginary part(RI) or phase(MA,DB) of measured parameter Sxy at measurement point n
 N : Number of measurement points
 Tab : Tab
 ↙ : Line break

e5070bsupe004

Change 10

The firmware revision A.05.00 or lower does not support the following functions. Please delete the descriptions about these functions from this manual.

- o User preset function
- o Function to display the marker values for non-active traces.
- o Function to change the display position where the marker values are displayed.
- o Function to align the marker values.
- o User recovery function*¹
- o TRL calibration by softkeys
- o Function to set the waveguide as the media type.
- o Loss correction.
- o Function to automaticall calculate the port extension and loss values.
- o Function to turn off the auto-detect function of the Ecal module (Manual setting is available).
- o Conversion function for differential/common port reference impedance of the fixture simulator in “Complex” format.

*1. This function is available when the volume label on the C-drive is CP600 or higher.

Manual Changes Manual Changes

- o Function to have the multiport test set E5091A-016 correspond to this instrument.
- o Function to select the 85052C as the calibration kit.
- o Function to specify up to eight calibration standards for each calibration class.
- o Reading/Writing files of the calibration standard.
- o Function to set the number of measurement points to a maximum of 20001.*1

Change 9

The equipment with prefix MY423 or earlier does not support the USB (USBTMC) interface port nor the removable hard disk function. Please refer to the following specifications for the rear view and the side view.

Figure A-15 **Dimensions (rear view, with Option 1E5, in millimeters, nominal)**

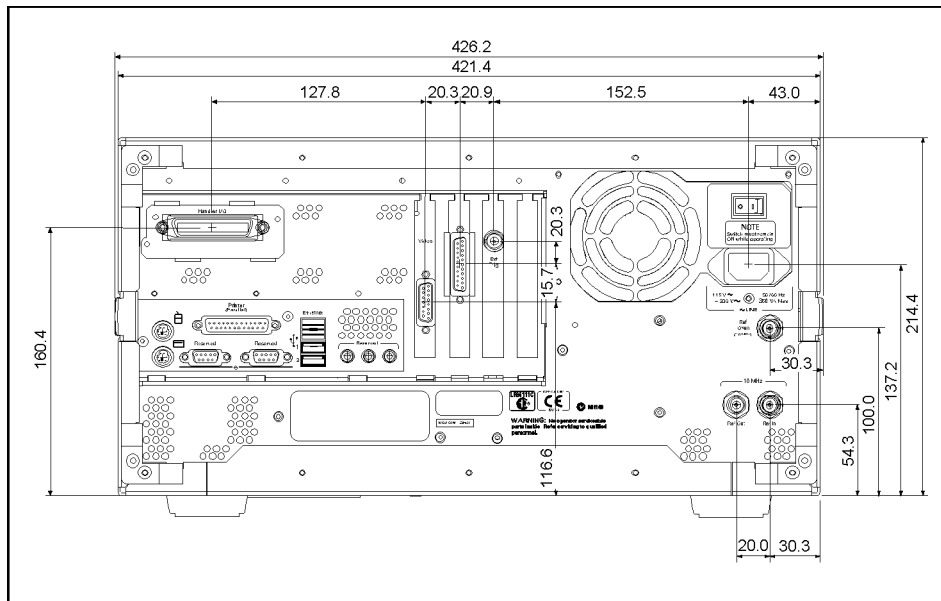

*1. This function is available when the channel/trace is set to Ch 1 / Tr 4 20001 Points.

Figure A-16 Dimensions (side view, in millimeters, nominal)

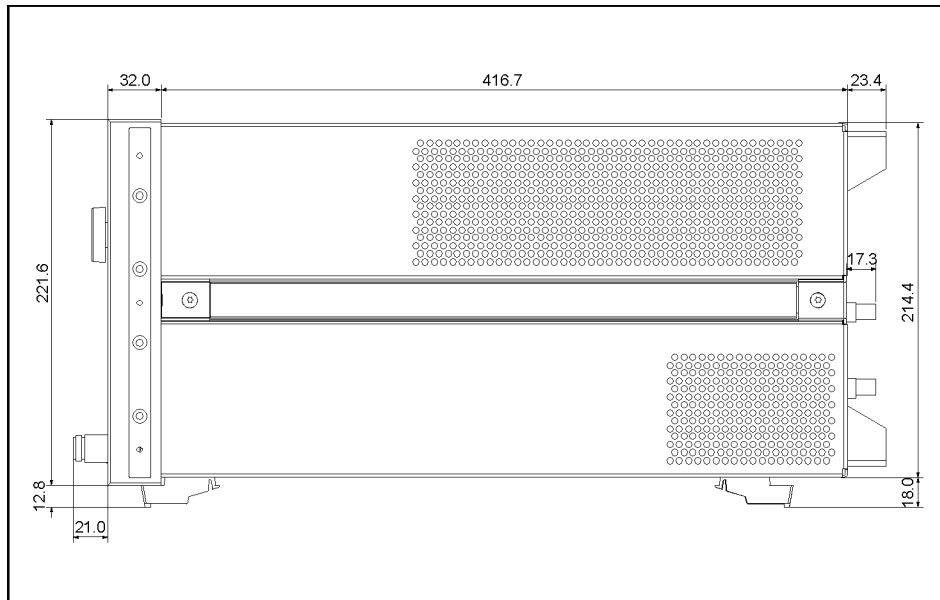

Change 8

The firmware revision A.04.00 or below does not support the following functions. Please disregard the descriptions of these functions in this manual.

- o Offset limit line function
- o Ripple test function
- o Bandwidth test function
- o Enhanced response calibration
- o Frequency information appearing as asterisks
- o Disable USB mass storage devices

Change 7

The firmware revision A.03.62 or below does not support the following functions. Please delete the descriptions about these functions in this manual.

- o Scalar-mixer calibration
- o Vector-mixer calibration
- o Absolute measurement function and receiver calibration
- o Frequency offset function (including the avoid spurious function)
- o External signal generator control function
- o Point trigger function
- o Z/Y Transmission-Shunt conversion
- o Imbalance 3 and 4 parameters for SE-SE-Bal measurement (Fixture simulator)

Manual Changes
Manual Changes

- o Assignable x-axis such as RF+LO, RF-LO, and LO-RF frequencies for each active trace
- o Conjugation for converting vector mixer measurement parameters
- o 7 mm calibration kits such as 85031B and 85050C/D
- o Calibration data and calibration coefficient clear functions

Change 6

Use Following specifications for the serial prefix MY422.

Table A-3

Description	Specification	Supplemental Information
Damage Level		
300 kHz to 8.5 GHz		RF +20 dBm, ±14 VDC (Source attenuator = 0 dB), ±25 VDC (Source attenuator = 5 dB or more), typical

Change 5

Use Following specifications for the serial prefix MY421 and JP1KK.

Table A-4 System Dynamic Range

Description	Specification	Supplemental Information
System Dynamic Range^{*1*2}		
300 kHz to 3 MHz	IF bandwidth = 3 kHz	85 dB
3 MHz to 1.5 GHz		95 dB
1.5 GHz to 4 GHz		97 dB
4 GHz to 6 GHz		93 dB
6 GHz to 7.5 GHz		88 dB
7.5 GHz to 8.5 GHz		81 dB
300 kHz to 3 MHz	IF bandwidth = 10 Hz	110 dB
3 MHz to 1.5 GHz		120 dB
1.5 GHz to 4 GHz		122 dB
4 GHz to 6 GHz		118 dB
6 GHz to 7.5 GHz		113 dB
7.5 GHz to 8.5 GHz		106 dB

- *1. The test port dynamic range is calculated as the difference between the test port rms noise floor and the source maximum output power. The effective dynamic range must take measurement uncertainty and interfering signals into account.
- *2. May be limited to 90 dB at particular frequencies below 350MHz or above 4.25GHz due to spurious receiver residuals.

Table A-5 Test Port Output Power^{*1}

Description	Specification	Supplemental Information
<p>Level Accuracy (at 23°C±5°C) 300 kHz to 10 MHz</p> <p>10 MHz to 8.5 GHz</p> <p>Level Accuracy (high temperature mode: ON) 300 kHz to 8.5 GHz</p> <p>Level Accuracy (swept mode) 300 kHz to 4.25 GHz</p> <p>4.25 GHz to 8.5 GHz</p>	<p>±0.650 dB (at 0 dBm, 50 MHz absolute) ±1.0 dB (at 0 dBm, relative to 50 MHz reference)</p>	<p>±1.0 dB (at 0 dBm, relative to 50 MHz reference)</p> <p>±0.8 dB (at 0 dBm, 50 MHz absolute) ±1.5 dB (at 0 dBm, relative to 50 MHz reference)</p> <p>±2.5 dB (at 0 dBm, relative to 50 MHz reference) ±3.5 dB (at 0 dBm, relative to 50 MHz reference)</p>
<p>Level Linearity (23°C±5°C) 10 MHz to 4.25 GHz 4.25 GHz to 6 GHz 6 GHz to 8.5 GHz</p> <p>Level Linearity (high temperature mode: ON) 300 kHz to 4.25 GHz 4.25 GHz to 6 GHz 6 GHz to 8.5 GHz</p>	<p>±0.75 dB (at -15 dBm to 10 dBm) ±0.75 dB (at -15 dBm to 8 dBm) ±0.75 dB (at -15 dBm to 6 dBm)</p>	<p>±1.5 dB (at -15 dBm to 10 dBm) ±2.0 dB (at -15 dBm to 8 dBm) ±2.0 dB (at -15 dBm to 6 dBm)</p>
<p>Level Linearity (swept mode) 300 kHz to 4.25 GHz 4.25 GHz to 6 GHz 6 GHz to 8.5 GHz</p>		<p>±1.5 dB (at -15 dBm to 10 dBm) ±3 dB (at -15 dBm to 8 dBm) ±3 dB (at -15 dBm to 6 dBm)</p>
<p>Range Standard 300 kHz to 4.25 GHz 4.25 GHz to 6 GHz 6 GHz to 8.5 GHz</p> <p>Extended Power Range (with option 214, 314, 414) 300 kHz to 4.25 GHz 4.25 GHz to 6 GHz 6 GHz to 8.5 GHz</p>	<p>-15 dBm to 10 dBm -15 dBm to 8 dBm -15 dBm to 6 dBm</p>	<p>-50 dBm to 10 dBm -50 dBm to 8 dBm -50 dBm to 6 dBm (non-harmonics spurious may limit power range)</p>

Table A-5 Test Port Output Power^{*1}

Description	Specification	Supplemental Information
Sweep Range (without extended power range) 300 kHz to 4.25 GHz 4.25 GHz to 6 GHz 6 GHz to 8.5 GHz	-15 dBm to 10 dBm -15 dBm to 8 dBm -15 dBm to 6 dBm	-20 dBm to 10 dBm -20 dBm to 8 dBm -20 dBm to 6 dBm
Level Resolution	0.05 dB	

*1. Source output performance on port 1 only. Other port output performance is typical.

Table A-6 Test Port Input Levels

Description	Specification	Supplemental Information
Maximum Test Port Input Level		
300 kHz to 4.25 GHz 4.25 GHz to 6 GHz 6 GHz to 8.5 GHz	+10 dBm +8 dBm +6 dBm	
Damage Level		
300 kHz to 8.5 GHz		+20 dBm, ±25 VDC, typical
Crosstalk^{*1}		
3 MHz to 3 GHz 3 GHz to 6 GHz 6 GHz to 7.5 GHz 7.5 GHz to 8.5 GHz	-120 dB -110 dB -100 dB -90 dB	

*1. Response calibration not omitted.

Table A-7 Test Port Input (Trace Noise)

Description	Specification	Supplemental Information
Trace Noise^{*1} Magnitude		
300 kHz to 3 MHz (source power level = +10 dBm)		5 mdB rms (typical) 8 mdB rms (high temperature mode: ON, typical)
3 MHz to 4.25 GHz (source power level = +10 dBm)	1 mdB rms (23°C±5°C)	4 mdB rms (high temperature mode: ON, typical)
4.25 GHz to 6 GHz (source power level = +8 dBm)	3 mdB rms (23°C±5°C)	6 mdB rms (high temperature mode: ON, typical)
6 GHz to 7.5 GHz (source power level = +6 dBm)	3 mdB rms (23°C±5°C)	6 mdB rms (high temperature mode: ON, typical)
7.5 GHz to 8.5 GHz (source power level = +6 dBm)	5 mdB rms (23°C±5°C)	8 mdB rms (high temperature mode: ON, typical)
Trace Noise^{*1} Phase		

Table A-7 Test Port Input (Trace Noise)

Description	Specification	Supplemental Information
300 kHz to 3 MHz (source power level = +10 dBm)		0.035 ° rms (23°C±5°C, typical) 0.05 ° rms (high temperature mode: ON, typical)
3 MHz to 4.25 GHz (source power level = +10 dBm)		0.007 ° rms (23°C±5°C, typical) 0.02 ° rms (high temperature mode: ON, typical)
4.25 GHz to 6 GHz (source power level = +8 dBm)		0.021 ° rms (23°C±5°C, typical) 0.035 ° rms (high temperature mode: ON, typical)
6 GHz to 7.5 GHz (source power level = +6 dBm)		0.021 ° rms (23°C±5°C, typical) 0.035 ° rms (high temperature mode: ON, typical)
7.5 GHz to 8.5 GHz (source power level = +6 dBm)		0.035 ° rms (23°C±5°C, typical) 0.05 ° rms (high temperature mode: ON, typical)

*1. Trace noise is defined as a ratio measurement of a through, at IFBW = 3 kHz.

Change 4

The firmware revision A.03.54 or below does not support the following functions. Please delete the descriptions about these functions in this manual.

- o Auto Power Range set function

Change 3

The equipments that firmware revision at the factory shipment is A.03.53 or below is not eligible for the following specs. support the following functions. Please refer to original attached manuals about them.

- o Initial Source Port Control function

Change 2

Figure 16-4 dimensions of rear view was changed. Eligible serial numbers are MY42100211 (for E5070B), MY42100407 (for E5071B) and later. For the earlier serial number equipment, please refer to original attached manuals.

Change 1

The firmware revision A.03.0x does not support the following functions. Please delete the descriptions about these functions in this manual

- o User Characterized ECal
- o Confidence check on calibration coefficients using ECal
- o 4-port network embedding/de-embedding (Fixture simulator)

Manual Changes
Manual Changes

- o Simplified full 3/4 port calibration
- o Loading and executing program in batch process

B Troubleshooting

This Chapter describes the steps to take in troubleshooting when your Agilent E5070B/E5071B appears to be operating improperly. Explanations are also given for the error warning messages displayed on the screen.

Troubleshooting

This section describes the steps you should take when you believe the Agilent E5070B/E5071B is operating improperly. The results of these simple investigative procedures may help you avoid the down-time and inconvenience of repair service. The troubleshooting instructions are divided into three categories:

- ❑ “Troubleshooting during Startup” on page 608
- ❑ “Troubleshooting during Operation” on page 609
- ❑ “Troubleshooting for External Devices” on page 612

Troubleshooting during Startup

The System Does Not Start Up.

- Turning on (I) the standby switch does not start up the system.
 - Confirm that the power cable is properly plugged in.
 - Confirm that the line switch on the rear panel is turned on (○). For the information on the line switch on the rear panel, see “7. Line Switch (Always ON)” on page 55.

When taking all the above measures does not result in normal operation, there is a possibility of a failure. Unplug the power cable immediately, and contact Agilent Technology’s Customer Contact listed at the end of this guide or the company from which you bought the device.

The system starts up, but the normal measurement screen does not appear.

- The system starts up, but it automatically shuts down immediately.
- The system starts up, but it enters the service mode (The instrument status bar in the lower right part of the screen displays **SVC** in red).
- The measurement screen appears after startup, but the date and time displayed on the instrument status bar in the lower right part of the screen differ greatly from the previous settings.
- The measurement screen appears after startup, but the power-on test is failed, with Error Message 241 appearing against a red background in the instrument message/warning area in the lower left part of the screen.
 - Execute the system recovery. For information on the execution procedure, see “System Recovery” on page 451.

There is a possibility of a failure. Contact Agilent Technology’s Customer Contact listed at the end of this guide or the company from which you bought the device.

NOTE

Occasionally, a few pixels may appear on the screen as a fixed point of blue, green or red. Please note that this is not a failure and does not affect the performance of your product.

Troubleshooting during Operation

The Sweep Action Stops during Measurement or Is Not Executed.

- The sweep action stops during measurement or is not executed, but the front keys and softkeys are operational.

There is a possibility of a failure. Contact Agilent Technology's Customer Contact listed at the end of this guide or the company from which you bought the device.

The Error Message "Port N receiver overload" (N denotes a port number) is Displayed.

- During the measurement of an amplifier, Error Messages 221 through 224 "Port N receiver overload" (N denotes a port number) on page 619 are displayed.
 This error occurs when the input to a test port exceeds the maximum input level in the measurement of an amplifier. The measurement value obtained in such a case is not correct. In the worst case, a failure (damage to the receiver) may occur.

- Change the measurement condition so that the input to the test port does not exceed the maximum input level.

When this message is displayed with nothing connected to the test port, there is a possibility of a failure of the instrument. Contact Agilent Technology's Customer Contact listed at the end of this guide or the company from which you bought the device.

A Clearly Abnormal Measurement Value

- The measurement value is not reproducible, or clearly abnormal.
 - Confirm that the DUT, connection cables, and other parts are connected correctly.
 - Confirm that the connectors and cables used to connect the DUT are free from damage and poor contact.
 - Confirm that the calibration has been executed correctly. If you have not acquired a correct error correction factor, you cannot obtain a correct measurement value.
 - Confirm that the calibration kit was selected correctly.
 - Confirm that the calibration kit is defined correctly.
 - Confirm that if the stimulus signal output is turned on.

When taking all these measures does not result in a correct measurement value, there is a possibility of a failure. Contact Agilent Technology's Customer Contact listed at the end of this guide or the company from which you bought the device.

The System Cannot be Operated Manually (Front Panel Keys, Keyboard, Touch Screen and Mouse)

- The keyboard or mouse becomes inoperable.
 - Confirm that the keyboard or mouse is connected correctly. When it is connected correctly, turn off the power once, and restart the system.
- The front panel key or keyboard becomes inoperable.
 - Using the mouse, turn **System – Key Lock – Front Panel & Keyboard Lock OFF**.

Troubleshooting

Troubleshooting

- The touch screen becomes inoperable.
 - Using the front panel keys, turn **System – Key Lock – Touch Screen & Mouse Lock** OFF.
 - Execute the calibration of the touch screen. For information on the execution procedure, see “Calibration of the Touch Screen” on page 470.
- The mouse becomes inoperable.
 - Using the front panel keys, turn **System – Key Lock – Touch Screen & Mouse Lock** OFF.
- All of the front panel keys, keyboard, and mouse become inoperable.
 - Confirm that the keyboard or mouse is connected correctly. When it is connected correctly, turn off the power once, and restart the system.
- The keyboard and mouse have been connected after power-on.
 - Turn off the power once, and restart the system.

When taking all these measures does not recover operability, there is a possibility of a failure. Contact Agilent Technology’s Customer Contact listed at the end of this guide or the company from which you bought the device.

The Screen Freezes and All Operations Become Impossible.

- The measurement in progress or screen update is stalled and all of the front panel keys, keyboard, mouse, and touch screen (Option 016) are inoperable.
 - Press the standby switch to turn off the power once, and restart the system.

When a similar symptom reappears, there is a possibility of a failure. Contact Agilent Technology’s Customer Contact listed at the end of this guide or the company from which you bought the device.

The System Freezes while in Operation.

- The system freezes while in operation.
 - Press the standby switch to turn off the power once, and restart the system.

The Rear Cooling Fan Does Not Operate.

There is a possibility of a failure. Contact Agilent Technology’s Customer Contact listed at the end of this guide or the company from which you bought the device.

You Cannot Save a File in a Floppy Disk.

- You cannot save a file in a floppy disk.
 - Confirm that the floppy disk is initialized. If not, initialize it.
 - Confirm that the floppy disk is inserted correctly. Insert a floppy disk until the eject button pops up fully.
 - Confirm that the floppy disk is not write-protected. If it is, unprotect the disk.
 - Confirm that the floppy disk has free space. If it does not, delete unnecessary files or use a new floppy disk.

When taking all these measures does not make it possible to save a file, there is a

possibility of a failure. Contact Agilent Technology's Customer Contact listed at the end of this guide or the company from which you bought the device.

You Cannot Read a File from a Floppy Disk.

- You cannot read a file from a floppy disk.
 - Confirm that the floppy disk is inserted correctly. Insert the floppy disk until the eject button pops up fully.
 - A stored file may be damaged by a magnetic field. Confirm that the file can be read on a PC.

When taking all these measures does not make it possible to read the file, there is a possibility of a failure. Contact Agilent Technology's Customer Contact listed at the end of this guide or the company from which you bought the device.

An Error or Warning Message Appears.

When an error or warning message is displayed on the instrument message/warning area in the lower part of the screen, refer to Error Messages on page 613 and Warning Messages on page 626.

Troubleshooting for External Devices

Cannot Output to a Printer

- Cannot output a measurement screen or data to a printer.
- Attempting to output to a printer causes Error Messages 120 and 121 on page 620 to appear.
 - Confirm that the power to the printer is on and that the line cable is connected correctly.
 - Confirm that the connector cable of the printer is connected correctly.
 - Confirm that the printer is online.
 - Confirm that the printer has not run out of paper.
 - Confirm that the printer has not run out of ink.

When taking all these measures does not result in printer output, there is a possibility of a failure. Contact Agilent Technology's Customer Contact listed at the end of this guide or the company from which you bought the device.

Does Not Respond to an External Controller/Fails to Function Normally

- A GPIB device does not respond to the external controller, or fails to function normally.
 - Confirm that the GPIB address is defined correctly.
 - Confirm that the GPIB cable is connected.
 - Confirm that another instrument connected by the GPIB cable has the same GPIB address.
 - Confirm that the GPIB cable connection forms a loop.

When taking all these measures does not result in correct operation of the GPIB devices, there is a possibility of a failure. Contact Agilent Technology's Customer Contact listed at the end of this guide or the company from which you bought the device.

Error Messages

An error message is displayed against a red background in the instrument message/warning area in the lower left part of the screen. Pushing a front panel key or executing :DISP:CCL command clears the error message. Errors caused by the operation of a front panel key simply appear on the display. They are not stored in the error queue with some exceptions.

An error with a positive error number is one uniquely defined for this instrument. On the other hand, an error with a negative error number is basically one defined for common GPIB devices in IEEE488.2

A

20

Additional standard needed

The GPIB command that turns ON the calibration function has been sent before all of the data measurements needed to calculate the calibration factor have been completed. In 1-port calibration, for example, when measurements completed for OPEN and SHORT standards but not yet for LOAD standard,

You have tried to turn on the calibration function by calculating 1-port calibration coefficient using SENS:CORR:COLL:SAVE or SENS:CORR:OFFS:COLL:SAVE. Be sure to measure all necessary calibration data before sending commands. This error is not generated by front key operations.

B

-168

Block data not allowed

An block-data element has been received at a position where this instrument does not accept one.

C

240

Calibration data lost

This error occurs when a file containing the system calibration data is not found or in a damaged state at time of the startup of this instrument, indicating a failure of this instrument. Contact an Agilent Technology sales office or the company from which you bought the instrument.

22

Calibration method not selected

This error occurs when the command for validating the calibration data, SENS:CORR:COLL:SAVE or SENS:CORR:OFFS:COLL:SAVE is executed before the command for selecting a calibration type, SENS:CORR:COLL:METH:xxxx or SENS:CORR:OFFS:COLL:METH:xxxx, is executed. This error is not generated by front key operations.

-148

Character data not allowed

A character data element (not violating the standard) has been received at a position where this instrument does not accept one. Double quotes (") are omitted where it is necessary to place a parameter in double quotes ("), for example.

- 100 **Command error**
- A comprehensive syntax error has occurred showing that this instrument cannot detect a more detailed error. This code simply shows that a command error defined in 11.5.1.1.4, IEEE488.2 has occurred.
- 60 **Continuous switching may damage source attenuator**
- This error occurs when different source attenuator (power range) settings are present during measurement on two or more channels. Performing such measurement for a long time is not recommended because of the possibility of the source attenuator being damaged. The measurement value is normal. This error occurs only on models with the extended power output (Option 214, 314, and 414). In firmware 3.60 and later, Auto Power Range set function may cause this error according to a channel setting. Refer to “Setting power level with Auto Power Range set function” on page 74.
- D**
- 222 **Data out of range**
- A data element (not violating the standard) outside the range defined by this instrument has been received. This error occurs when an integer-based command for which the parameter can be rounded exceeds the range of -65536 to +65536 or when a real-number-based command for which the parameter can be rounded exceeds the range of -9.9e37 to +9.9e37, for example.
- This error occurs also when a numeric value other than a specified one is entered into a command in which the “port number” and “CalKit number” are specified as parameters and hence the parameters are not rounded. Such commands are, for example, CALC:FSIM:BAL:TOP:BBAL:PPOR, SENS:CORR:COLL:ACQ:OPEN, SENS:CORR:COLL:ECAL:SOLT3, SENS:CORR:COLL:CKIT:ORD:LOAD, etc.
- 104 **Data type error**
- The parser has recognized a data element that must not exist. Block data has been sent instead of numeric value data or character string data that had been expected, for example.
- E**
- 32 **ECal module not in appropriate RF path**
- This error occurs when an ECal command, SENS:CORR:COLL:ECAL:SOLTn or SENS:CORR:OFFS:COLL:ECAL:xxxx, is executed with the port on the ECal module not connected correctly to the instrument. When the auto-detect function is turned OFF, (SENS:CORR:COLL:ECAL:ORI OFF), however, this error does not occur even when the port on the ECal module is not connected correctly to the instrument .
- 200 **Execution error**
- An error associated with execution has been generated for which this instrument cannot specify the error message. This code shows that an error associated with execution defined in 11.5.1.1.5, IEEE488.2 has occurred. This error occurs also when a calibration measurement is aborted.
- 123 **Exponent too large**
- The absolute value of the exponent exceeds 32,000 (see 7.7.2.4.1, IEEE488.2).

- 178 **Expression data not allowed**
An expression-data element has been received at a position where this instrument does not accept one.
- 170 **Expression error**
When the expression data is put to syntactic analysis, an error not corresponding to one of Error Numbers -171 through -179 occurs.
- F**
- 31 **Failed to configure ECal module**
This error occurs when the control of the ECal module fails at time of executing an ECal command, SENS:CORR:COLL:ECAL:SOLTn or SENS:CORR:OFFS:COLL:ECAL:xxxx. The failure results from the failure to connect the ECal module to the USB port, failure of the ECal module, etc.
- 76 **Failed to control signal generator**
This error occurs when the external signal source fails to respond during measurement, though it is enabled (SENS:OFFS:LOC:STAT ON and SENS:OFFS:LOC:CONT ON).
Ensure the connection of the external signal source.
- 102 **Failed to copy file**
This error occurs when copying a file (MMEM:COPY command) fails.
- 104 **Failed to create directory**
This error occurs when creating a directory (MMEM:MDIR command) fails.
- 103 **Failed to delete file**
This error occurs when deleting a file (MMEM:DEL command) fails.
- 100 **Failed to read file**
This error occurs when a 2-port touchstone file (CALC:FSIM:SEND:PMC:PORT:USER:FIL command), the formatted data array (MMEM:LOAD:FDAT command) and limit table (MMEM:STOR:LIM command) for the active trace on the active channel, segment sweep table (MMEM:LOAD:SEGM command) for the active channel, a VBA project file (MMEM:LOAD:PROG command), etc. cannot be read normally.
- 101 **Failed to write file**
This error occurs when the formatted data array (MMEM:STOR:FDATcommand) and limit table (MMEM:STOR:LIM command) for the active trace on the active channel, segment sweep table (MMEM:STOR:SEGM command) for the active channel, display image (MMEM:STOR:IMAG command) for the LCD screen, a VBA project file (MMEM:STOR:PROG command), etc. cannot be written normally.
- 257 **File name error**
A file name error. This message appears when an error exists in the file name and hence a command is not executed correctly. This error occurs when you try to copy to an unsuitable file name, for example.

- 256 **File name not found**
The file name specified is not found and hence the command is not executed correctly. This error occurs when you try to read a file that does not exist in a disk or a disk is not correctly inserted into the drive to read or write a file, for example.
- 107 **File transfer failed**
This error occurs when writing data into or reading data from a file (MMEM:TRAN command) fails.
- 56 **Fixture Simulator not allowed**
This error occurs when the fixture simulator is executed (CALC:FSIM:STAT ON) under the condition of the frequency offset is enabled (SENS:OFFS ON).
The fixture simulator is allowed to use when the frequency offset is not enabled.
- 24 **Frequency offset enabled**
This error occurs when the normal calibration (SENS:CORR:COLL:OPEN etc.) is performed under the condition of the frequency offset is enabled (SENS:OFFS ON).
- 25 **Frequency offset not enabled**
This error occurs when the scalar-mixer calibration (SENS:CORR:OFFS:COLL:OPEN etc.) is performed under the condition of the frequency offset is not enabled (SENS:OFFS OFF).
- 62 **Frequency out of range**
This error occurs when the setting of frequency exceeds output frequency range under the condition of the frequency offset is enabled (SENS:OFFS ON).
- G**
- 105 **GET not allowed**
A group execution trigger (GET) has been received in the program message (see 7.7, IEEE488.2).
- H**
- 114 **Header suffix out of range**
The unit of the header is outside the range. The header is invalid in the unit for numeric parameters following a SCPI command.
- I**
- 224 **Illegal parameter value**
The parameter value is not suitable. This error occurs when the CALC:PAR:DEF command is used to specify an S-parameter that does not exist in the model (S44 in the case of a 2-port model), for example.
- 282 **Illegal program name**
This error occurs when a nonexistent VBA program name is specified by the PROG:SEL:NAME command.

-213	<p>Init ignored</p> <p>Because another measurement is in progress, the request for initiating a measurement (“INIT” command) is ignored.</p>
35	<p>Insufficient ECal module memory</p> <p>This error occurs when the embedded memory is insufficient to save the user property in ECal module during the user definition ECal processing.</p>
-161	<p>Invalid block data</p> <p>Block data has been expected, but the block data that appears is invalid for some reason (see 7.7.6.2, IEEE488.2). The END message is received before the length of block data has been filled, for example.</p>
28	<p>Invalid calibration method</p> <p>If the type of calibration is not specified or not correct when partial overwrite is executed with the GPIB command, this error occurs. This error does not occur for operation with front keys.</p>
-101	<p>Invalid character</p> <p>An invalid character exists in the program message character string.</p>
-141	<p>Invalid character data</p> <p>An invalid character is found in the character data element, or the parameter received is not valid.</p>
-121	<p>Invalid character in number</p> <p>A character that is invalid for the data type subject to syntactic analysis has been received. For example, a letter is found in a decimal numeric value or a numeric character “9” in octal data.</p>
500	<p>Invalid equation expression</p> <p>This error occurs when the invalid equation is specified in the equation of the equation editor.</p>
501	<p>Invalid equation label</p> <p>This error occurs when the invalid equation label is specified in the equation of the equation editor.</p> <p>A space is not available for the equation label.</p>
-171	<p>Invalid expression</p> <p>The expression-data element is invalid (see 7.7.7.2, IEEE488.2). Parentheses are not paired, or illegal characters are used, for example.</p>
-103	<p>Invalid separator</p> <p>The parser (a syntactic analysis program) had been expecting a delimiter, but a character that is not a delimiter has been sent.</p>
-151	<p>Invalid string data</p> <p>Character string data has been expected, but the character string data that appears is invalid for some reason (see 7.7.5.2, IEEE488.2). The END message is received before the ending quotation mark character appears, for example.</p>
-131	<p>Invalid suffix</p>

The suffix does not comply with the syntax defined in 7.7.3.2, IEEE488.2. Or it does not suit E5070B/E5071B.

L

53 **Log sweep requires 2 octave minimum span**

The span of sweep range is not satisfied the requirement for logarithmic sweep. The sweep type is automatically changed to linear sweep when this error occurs.

For example, this error occurs when, with the start and stop frequency are set 1 MHz and 2 MHz respectively, the sweep type is changed to logarithmic sweep.

Set the stop frequency to more than four times as many as the start frequency. And then select logarithmic sweep.

M

-109 **Missing parameter**

The number of parameters is less than that required for the command, or the parameter has not been entered. For example, the command SENS{1-6}:SWE:POIN requires one more parameter.

Therefore, when a message “SENS1:SWE:POIN” is sent to a correct program message “SENS1:SWE:POIN 201” this instrument receives the former message as an invalid one because all parameters have not been entered. Enter command parameters correctly.

N

70 **No GPIB system controller**

The GPIB system controller is not set properly.

This error occurs when USB/GPIB interface is not connected or the interface setting is improper, during the measurement for power calibration data or for that in scalar-mixer calibration.

It also occurs when USB/GPIB interface is not connected or the interface setting is improper, though the control of the external signal source is enabled.

Ensure the connection of USB/GPIB interface and its setting.

52 **No valid memory trace**

This error occurs when you have executed either DISP:WIND:TRAC:MEM ON command to display memory trace, or any other command to enable data calculation using memory trace (CALC:MATH:FUNC command with other than NORM is specified), though no valid data exists in memory trace. This error is not generated by front key operations.

-120 **Numeric data error**

An error resulting from the numeric value data (including numeric value data having no decimal point representation) has occurred. A numeric value error other than Errors -121 through -129 has occurred.

-128 **Numeric data not allowed**

An numeric-value-data element (not violating the standard) has been received at a position

where this instrument does not accept one.

O

200

Option not installed

The command received has been ignored because of the mismatch between the contents of an option for this instrument and the command.

For example, this error occurs when the source attenuator (power range) is set at a value other than zero (SOUR:POW:ATT command) in a model not having the extended power output option.

It also occurs when you try to enable the time domain function in a model not having the time domain option. This holds true for the frequency offset option.

This error is not generated by front key operations.

-225

Out of memory

Insufficient memory is available in this instrument to perform the required operation.

P

-220

Parameter error

When a parameter-related error other than Errors -221 through -229 occurs, that error is displayed.

-108

Parameter not allowed

The number of parameters exceeds that required for the command.

For instance, when a program message “:SENS1:SWE:TYPE LIN, SEGM” is sent instead of a correct program message with a command “:SENS1:SWE:TYPE LIN” which requires a parameter, the instrument receives the message as the number of parameters is invalid. See the command reference to confirm the required number of parameters.

41

Peak not found

This error occurs when, after specifying a peak and executing the CALC:MARK:FUNC:EXEC and CALC:FUNC:EXEC commands, the specified peak is not found in the marker search analysis.

220

Phase lock loop unlocked

This error occurs when the PLL circuit of this instrument becomes unlocked while the measurement is in progress. The measurement value is not correct. This error may occur when an external reference out of specification is connected to this instrument. Should an error occur with an external reference not connected, this instrument is faulty. Contact an Agilent Technology sales office or the company from which you bought the instrument.

221

Port 1 receiver overload

The input to Test Port 1 exceeds the maximum input level. The measurement value is not correct. When a DUT is an amplifier or the like, this error may occur, damaging the receiver in the worst case. Should this error occur with a passive part used as the DUT or with nothing connected to the test port, this instrument is faulty. Contact an Agilent Technology sales office or the company from which you bought the instrument.

If this error occurs, the stimulus signal output is automatically turned off.

- 222 **Port 2 receiver overload**
- The input to Test Port 2 exceeds the maximum input level. The measurement value is not correct. When a DUT is an amplifier or the like, this error may occur, damaging the receiver in the worst case. Should this error occur with a passive part used as the DUT or with nothing connected to the test port, this instrument is faulty. Contact an Agilent Technology sales office or the company from which you bought the instrument.
- If this error occurs, the stimulus signal output is automatically turned to off.
- 223 **Port 3 receiver overload (for Options 313, 314, 413, and 414 only)**
- The input to Test Port 3 exceeds the maximum input level. The measurement value is not correct. When a DUT is an amplifier or the like, this error may occur, damaging the receiver in the worst case. Should this error occur with a passive part used as the DUT or with nothing connected to the test port, this instrument is faulty. Contact an Agilent Technology sales office or the company from which you bought the instrument.
- If this error occurs, the stimulus signal output is automatically turned to off.
- 224 **Port 4 receiver overload (For Options 413 and 414 only)**
- The input to Test Port 4 exceeds the maximum input level. The measurement value is not correct. When a DUT is an amplifier or the like, this error may occur, damaging the receiver in the worst case. Should this error occur with a passive part used as the DUT or with nothing connected to the test port, this instrument is faulty. Contact an Agilent Technology sales office or the company from which you bought the instrument.
- If this error occurs, the stimulus signal output is automatically turned to off.
- 73 **Power meter not settled**
- The measurement value of the power meter is unstable, or it goes outside the tolerance.
- This error occurs when the power meter's measurement value does not become stable within about 10 seconds during measurement for power calibration data or that for scalar-mixer calibration data.
- This error also occurs when the power calibration value exceeds the set tolerance.
- In addition, it occurs when the power meter fails to respond for any reason, such as power-down for example, during measurement under the same conditions.
- Ensure a firm connection of the power sensor.
- 241 **Power on test failed**
- This error occurs when the power-on test fails, indicating a failure of this instrument. Contact an Agilent Technology sales office or the company from which you bought the instrument.
- 61 **Power unlevelled**
- The out power level exceeds available range.
- For example, if the level after correction exceeds the power level that can be outputted when correcting the power level with the power calibration and power slope feature, this error occurs.
- Check that the power level is set correctly, the power calibration has been performed correctly and the correction value of the power slope is set correctly.
- 120 **Printer error**

- This error occurs when the previous printing is still in progress or the printer fails (offline, short of paper, etc.) at time of outputting the display image on the LCD screen to the printer (HCOP:IMM command).
- 121 **Print failed**
- This error occurs when printing fails for reasons other than Error 120, Printer error.
- 284 **Program currently running**
- This error occurs when the PROG:SEL:STAT RUN command is executed with the VBA program in the Run state.
- 112 **Program mnemonic too long**
- The length of the header exceeds 12 characters (see 7.6.1.4.1, IEEE488.2).
- 286 **Program runtime error**
- An error occurring when VBA is executed.
- Q**
- 430 **Query DEADLOCKED**
- The state that generates a “DEADLOCKED” Query error (see 6.3.1.7, IEEE488.2). This error occurs when both input and output buffers have become full, preventing the instrument from continuing processing, for example.
- 400 **Query error**
- A comprehensive query error has occurred showing that this instrument cannot detect a more detailed error. This code simply shows that a query error defined in 11.5.1.1.7 and 6.3, IEEE488.2 has occurred.
- 410 **Query INTERRUPTED**
- The state that generates a “INTERRUPTED” Query error (see 6.3.2.3, IEEE488.1). This error occurs when data bytes (DAB) or GET are received before the transmission of the response after a query has not been completed, for example.
- 420 **Query UNTERMINATED**
- The state that generates an “UNTERMINATED” Query error (see 6.3.2, IEEE488.2). This error occurs when this instrument is designated as the talker and an incomplete program message is received, for example.
- 440 **Query UNTERMINATED after indefinite response**
- After a query asking for an indefinite response has been run, another query is received in the same program message (See 6.5.7.5.7, IEEE488.2).
- 350 **Queue overflow**
- The queue contains a specific code in place of the code which caused this error. The code indicates that the error occurred because of no space available in the queue, but the error is not recorded.
- R**
- 105 **Recall failed**

Troubleshooting
Error Messages

This error occurs when reading an instrument status file (State01.sta, etc.) (MMEM:LOAD:STAT command) fails.

S

106

Save failed

This error occurs when writing an instrument status file (State01.sta, etc.) (MMEM:STOR:STAT command) fails.

33

Selected parameter not valid for confidence check

This error occurs when the mix mode S parameter has been selected for the S parameter you want to check, while using the confidence check function for calibration coefficient.

57

SnP request not valid for selected measurement

This error occurs when you try to save data to a Touchstone file but no measurement has been executed.

This error also occurs when you try to save a Touchstone file with power sweep measurement specified or with the frequency offset function set to ON.

50

Specified channel hidden

This error occurs when an attempt is made to activate a channel not on display using the DISP:WIND:ACT command. This error is not generated by front key operations.

23

Specified error term does not exist

The error occurs when the calibration coefficient type of the parameter specified in the read/write command of the calibration coefficient (SENS:CORR:COEF) is invalid for the calibration type selected by the calibration type selection command (SENS:CORR:COEF:METH:xxxx.) This error is not generated by front key operations.

21

Specified ports overlapped

This error occurs when a port number is duplicated in a command requiring two or more port numbers as parameters. Such commands are, for example, CALC:FSIM:BAL:TOP:SSB:PPOR 1,2,3,3. Specify port setup correctly to avoid duplication of ports. This error is not generated by front key operations.

51

Specified trace dose not exist

This error occurs when CALC:PAR:SEL command is executed to activate more traces than specified by CALC:PAR:COUN command. This error is not generated by front key operations.

26

Standard not selected

This error occurs when you execute the measurement under the condition that the standard is not selected for the subclass (the standard number is set to 0).

-150

String data error

When a character-string-data element is put to syntactic analysis, an error not corresponding to one of Error Numbers -151 through -159 occurs.

-158

String data not allowed

A character-string-data element has been received at a position where this instrument does not accept one.

- 138 **Suffix not allowed**
A suffix is attached to a numeric value element to which a suffix is not allowed to be attached.
- 134 **Suffix too long**
The unit is too long.
The unit is expressed in 12 or more characters (see 7.7.3.4, IEEE488.2).
- 55 **Sweep mode changed to stepped sweep**
You cannot change the sweep mode to the swept mode.
This error occurs when you change the sweep mode to the swept mode/high speed swept mode under the conditions where the sweep type is set to power sweep, power slope function is enabled (ON, correction coefficient is other than zero), power calibration is ON, frequency offset is enabled, spurious avoidance of frequency offset is enabled, or external signal source control is enabled.
- 102 **Syntax error**
A command or data type that is not recognized exists.
- 310 **System error**
One of the errors designated as “system errors” in this instrument has occurred.
- T**
- 40 **Target value not found**
This error occurs when the target is not found during the marker search analysis after specifying the target and executing the CALC:MARK:FUNC:EXEC and CALC:FUNC:EXEC commands. This error occurs also when the bandwidth is not found after executing the bandwidth marker command, CALC:MARK:BWID:DATA?
- 124 **Too many digits**
The number of digits of the argument of the decimal numeric-value-data element exceeds 255 with the preceding 0 removed (see 7.7.2.4.1, IEEE488.2).
- 223 **Too much data**
The block-, expression-, or character-string-type program data that has been received conforms with the standard. But it exceeds the amount that can be processed under the condition of the memory or conditions specific to memory-related devices. In this instrument, this error occurs when the number of characters exceeds 254 in a character-string parameter.
- 54 **Transform, Gate not allowed**
This message appears when you turn on the gating/conversion function of the time domain feature, while frequency offset is enabled, measurement points are set to two, or sweep type is set to other than linear sweep
Turn off the frequency offset (SENS:OFFS OFF command), set the measurement points to three or more and the sweep type to linear sweep, and then turn on the gating/conversion function.
- 211 **Trigger ignored**

This instrument receives and detects a trigger command (“TRIG”) or an external trigger signal. But it is ignored due to the timing condition (This instrument is not in the wait-for-trigger state, for example). Change the setup so that a trigger command or an external trigger signal can be sent after the instrument has entered the wait-for-trigger state.

U

300 **Unable to estimate adapter length**

Adapter length can not be estimated at zero span. Change the frequency span other than 0.

-113 **Undefined header**

A command not defined in this instrument, though not illegal in the syntactic structure, has been received. For example, when a message “:DISP:WIND1:TABL:MEM ON” is sent to a correct program message “:DISP:WIND1:TRAC1:MEM ON,” the message sent is received as an undefined command by this instrument. See the command reference and use correct commands.

This error occurs also when a port not existing on this model is specified in a command specifying a port number as an index. Such commands are CALC:FSIM:SEND:DEEM:PORTn:xxxx, CALC:FSIM:SEND:PMC:PORTn:xxxx, CALC:FSIM:SEND:ZCON:PORTn:Z0:R, and SENS:CORR:EXT:PORTn:TIME; they include PORTn as a part.

34 **User characterization not found in module**

This error occurs when the selected user profile is not detected in the ECal memory, while reading it from the ECal module, written by the user definition ECal.

V

30 **Valid Ecal module not found**

This error occurs when the number of ports of the ECal module connected is less than the necessary number of ports. This error occurs, for example, when a 4-port Cal executing command, SENS:CORR:COLL:ECAL:SOLT4, is executed with a 2-port ECal module connected. This error is not generated by front key operations.

71 **Valid power meter not found**

Valid power meter is not connected (see Table 4-9 on page 209).

This error occurs when the E5070B/E5071B and the power meter is not connected with USB/GPIB interface, the GPIB addresses do not match between the power meter and the E5070B/E5071B’s power meter, or the power meter is turned off, during the measurement for power calibration data or for that in scalar-mixer calibration.

It also occurs when inoperable power meter is connected.

Ensure the connection of the power meter, GPIB addresses and power supply.

72 **Valid power sensor not found**

No valid sensor is connected to the power meter.

This error occurs when no power sensor is connected to the specified channel of the power meter, during the measurement for power calibration data or for that in scalar-mixer calibration.

75

Ensure the connection of the power sensor.

Valid signal generator not found

No valid external signal source is connected.

This error occurs when the specified type of external signal source is not connected to the specified GPIB address, though the control of the external signal source is enabled (SENS:OFFS:LOC:STAT ON and SENS:OFFS:LOC:CONT ON).

It also occurs when USB/GPIB interface is set but not connected.

Ensure the external signal source and the connection of USB/GPIB interface.

Warning Message

A warning message is displayed in the instrument message/Warning area in the lower left part of the display against a gray background. Pushing a front panel key or executing :DISP:CCL command clears the message.

This message simply appears on the display, being not known to a remote environment such as a GPIB. This message is not displayed when another error (against a red background) has already been displayed in the instrument message/Warning area.

The warning messages for this instrument are as follows:

Auto port extension not allowed

This message appears when you try to execute the auto port extension when the sweep type is power sweep or the frequency offset function is ON.

If this message is displayed, the auto port extension is not available.

Calibration extrapolated

The frequency range that can be calibrated with the ECal module is exceeded. In this case, the calibration data for the minimum frequency or maximum frequency are used instead of the data exceeding the allowable frequency range for calibration.

Fixture simulator not allowed

This message appears when enabling the frequency offset, while the fixture simulator function is turned on.

If this message is displayed, the fixture simulator function is automatically turned off.

Log sweep requires 2 octave minimum span

If you change the sweep range that does not satisfy the necessary condition of the frequency span (the stop frequency is about 4 times or more of the start frequency) when the sweep type is set to the log sweep, this message is displayed.

If this message is displayed, the sweep type is automatically set to the linear sweep.

For example, if you attempt to change the log type to the log sweep when the start frequency is set to 1 MHz and the stop frequency to 2 MHz, this error occurs.

Set the stop frequency to a value of about 4 times or more the start frequency and then set the low sweep.

Peak not found

This warning message is displayed when, with the tracking turned on, the peak specified by the marker search has not been found by the time the sweep is finished (with the tracking executed).

Segment table changed

This warning message is displayed when the setting specified segment by segment in the segment table is automatically changed by a change in the other setting.

For example, this warning message is displayed when, with the power specified segment by segment in the segment table, the power setting for a segment is adjusted by a change in the power range setting.

Sweep mode changed to stepped sweep

This message appears when you set the sweep type to power sweep, power slope function to enabled (ON, correction coefficient is other than zero), power calibration to ON, frequency offset to enabled, spurious avoidance of frequency offset to enabled, or external signal source control to enabled, while the sweep mode is set to swept mode or high speed swept mode.

When this message is displayed, the sweep mode is automatically set to step mode (during swept mode) or high speed step mode (during high speed swept mode).

Target value not found

This warning message is displayed when, with the tracking turned on, the target specified by the marker search has not been found by the time the sweep is finished (with the tracking executed).

This warning message is displayed also when, with the bandwidth marker displayed, the setting for the bandwidth marker is changed at the end of the sweep, or when, with the active marker changed or moved, the bandwidth is not found.

Transform, Gate not allowed

This message appears when you have set the measurement points to two, sweep type to other than linear sweep, or frequency offset to enabled, while the gating/conversion function of the time domain feature is turned on.

If this message is displayed, the gating/conversion function is automatically turned off.

User Preset File not found

This warning message is displayed if no user preset file (D:\UserPreset.sta) exists when executing the SYST:UPR command.

If this message is displayed, a normal preset (SYST:PRES) will be performed.

For details on setting the user preset function, see “Setting the user preset function” on page 449.

Troubleshooting
Warning Message

C **List of Default Values**

This appendix gives the default values, settings for Save/Recall of an object, and settings for backing up an object when using the Agilent E5070B/E5071B.

List of Default Values, Save/Recall Settings, and Backup Settings

The table below shows the following settings for the Agilent E5070B/E5071B.

- Factory-shipped settings
- Settings valid when you press **Preset** (Or when you execute the **:SYST:PRES** command)
- Settings valid when you execute the ***RST** command
- Settings that permit Save/Recall of a setup state

In the table, states that can be saved/recalled are denoted in the following manner:

√: Save/Recall can be performed

Blank: Save/Recall cannot be performed

- Settings that are backed up (set state not affected by turning power ON/OFF)

In the table, a setting that is automatically backed up is denoted in the following manner:

√: Backup operation performed

Blank: Backup operation not performed

- Available means of defining a setting

In the table, the following symbols are used to denote the method(s) that can be used to define a setting.

K: Using the front panel key (including the mouse and keyboard)

C: Using the SCPI command or COM object

NOTE

In the table, the ← symbol shows that the setup is the same as that in the box to the left.

List of Default Values, Save/Recall Settings, and Backup Settings

Key Operation	Factory-shipped Setting	Default Value		Save/ Recall	Backup	Available Means of Defining a Setting
		Preset	*RST			
Meas	S11	←	←	√		K/C
	Sss11 (When Fixture Simulator is set on, set Topology at SE-Bal, and, BalUn on in Analysis mode)	←	←	√		K/C
	Sdd11 (When Fixture Simulator is set on, set Topology at Bal-Bal, and BalUn on in Analysis mode)	←	←	√		K/C
	Sss11 (When Fixture Simulator is set on, set Topology at SE-SE-Bal, and BalUn on in Analysis mode)	←	←	√		K/C
Format	Log Mag	←	←	√		K/C
Scale						
Divisions	10	←	←	√		K/C
Scale/Div	10.000 dB/div	←	←	√		K/C
Reference Position	5 Div	←	←	√		K/C
Reference Value	0.0000 dB	←	←	√		K/C
Electrical Delay	0.0000 s	←	←	√		K/C
Phase Offset	0.0000 °	←	←	√		K/C
Display						
Allocate Channels	<input type="text" value="x1"/>	←	←	√		K/C
Number of Traces	1	←	←	√		K/C
Allocate Traces	<input type="text" value="x1"/>	←	←	√		K/C
Display	Data	←	←	√		K/C
Data Math	OFF	←	←	√		K/C
Equation	OFF	←	←	√		K/C
Title Label	OFF	←	←	√		K/C
Graticule Label	ON	←	←	√		K/C
Invert Color	OFF	←	←	√		K/C
Frequency	ON	←	←	√		K/C
Update	ON	←	←	√		K/C
Avg						
Avg Factor	16	←	←	√		K/C
Averaging	OFF	←	←	√		K/C
Avg Trigger	OFF	←	←	√		K/C
SMO Aperture	1.5000%	←	←	√		K/C
Smoothing	OFF	←	←	√		K/C
IF Bandwidth	70 kHz	←	←	√		K/C

List of Default Values

List of Default Values, Save/Recall Settings, and Backup Settings

Key Operation	Factory-shipped Setting	Default Value		Save/ Recall	Backup	Available Means of Defining a Setting
		Preset	*RST			
Cal						
Correction	OFF	←	←	√		K/C
Calibrate						
Response (Open)						
Select Port	1	←	←			K/C
Response (Short)						
Select Port	1	←	←			K/C
Response (Thru)						
Select Ports	2-1 (S21)	←	←			K/C
Enhanced Response						
Select Ports	2-1 (S21 S11)	←	←			K/C
1-Port Cal						
Select Port	1	←	←			K/C
2-Port Cal						
Select Ports	1-2	←	←			K/C
3-Port Cal						
Select Ports	1-2-3	←	←			K/C
2-Port TRL Cal						
Select Ports	1-2	←	←			K/C
3-Port TRL Cal						
Select Ports	1-2-3	←	←			K/C
Adapter Removal						
Select Port	1	←	←			K/C
Adapter Length	AUTO	←	←			K/C
ECal						
Enhanced Response	2-1 (S21 S11)	←	←			K/C
Isolation	OFF	←	←	√		K/C
Characterization	Factory	←	←	√		K/C
Orientation	Auto	←	←	√		K/C
Unknown Thru	OFF	←	←	√		K/C
Property	OFF	←	←	√		K/C
Cal Kit	85033E	←	←	√		K/C
Modify Cal Kit						
Define STDs	Define STDs	←	←	√		K
Specify CLSs						
Open	Open	←	←	√		K

List of Default Values
List of Default Values, Save/Recall Settings, and Backup Settings

Key Operation	Factory-shipped Setting	Default Value		Save/ Recall	Backup	Available Means of Defining a Setting
		Preset	*RST			
Cal						
Port Extensions						
Extensions	OFF	←	←	√		K/C
Auto Port Extension						
Select Ports	1,2,3,4	←	←	√		K/C
Method	Current Span	←	←	√		K/C
User Span Start	300.00 kHz	←	←	√		K/C
User Span Stop	3.0000 GHz (E5070B) 8.5000 GHz (E5071B)	←	←	√		K/C
Adjust Mismatch	OFF	←	←	√		K/C
Include Loss	OFF	←	←	√		K/C
Extension Port1	OFF	←	←	√		K/C
Extension Port2	OFF	←	←	√		K/C
Extension Port3	OFF	←	←	√		K/C
Extension Port4	OFF	←	←	√		K/C
Loss						
Select Port	1	←	←	√		K/C
Loss1	OFF	←	←	√		K/C
Loss1	0.0000 dBm	←	←	√		K/C
Freq1	1.0000 GHz	←	←	√		K/C
Loss2	OFF	←	←	√		K/C
Loss2	0.0000 dBm	←	←	√		K/C
Freq2	1.0000 GHz	←	←	√		K/C
Loss at DC	0.0000 dBm	←	←	√		K/C
Velocity Factor	1.0000	←	←	√		K/C
Power Calibration						
Select Port	1	←	←			K
Correction	OFF	←	←	√		K/C
Use Sensor	A	←	←			K
Num of Readings	1	←	←	√		K/C
Tolerance	5.000 dB	←	←	√		K/C
Loss Compen						
Compensation	OFF	←	←	√		K/C
Sensor A Settings						
Ref Cal Factor	100.00%	Non-changing	←	√		K/C
Sensor B Settings						
Ref Cal Factor	100.00%	Non-changing	←	√		K/C

List of Default Values

List of Default Values, Save/Recall Settings, and Backup Settings

Key Operation	Factory-shipped Setting	Default Value		Save/ Recall	Backup	Available Means of Defining a Setting
		Preset	*RST			
Cal						
Receiver Calibration						
Select Port	1	←	←			K
Correction	OFF	←	←	√		K/C
Source Port	1	←	←			K
Mixer/Converter Calibration	When Frequency Offset is set on, this softkey is enabled.					
Scalar Cal (Manual)						
Select Ports	2-1 (fwd)	←	←			K
Power Meter						
Use Sensor	A	←	←			K
Scalar Cal (ECal)						
Select Ports	2-1 (fwd)	←	←			K
Power Meter						
Use Sensor	A	←	←			K
Cal Trig Source	Internal	←	←	√		K/C
Start	300.00 kHz	←	←	√		K/C
Stop	3.0000 GHz (E5070A) 8.5000 GHz (E5071A)	←	←	√		K/C
Center	1.50015 GHz (E5070A) 4.25015 GHz (E5071A)	←	←	√		K/C
Span	2.9997 GHz (E5070A) 8.4997 GHz (E5071A)	←	←	√		K/C
Sweep Setup						
Power						
Power	0 dBm	←	←	√		K/C
Power Ranges	-25 to 7	←	←	√		K/C
Auto Range	ON	←	←	√		K/C
Port Couple	ON	←	←	√		K/C
Port Power						
Port 1 Power	0 dBm	←	←	√		K/C
Port 2 Power	0 dBm	←	←	√		K/C
Port 3 Power	0 dBm	←	←	√		K/C
Port 4 Power	0 dBm	←	←	√		K/C
Sweep Setup						
Power						
Slope [xx dB/GHz]	0 dB/GHz	←	←	√		K/C
Slope [ON/OFF]	OFF	←	←	√		K/C
CW Freq	300.00 kHz	←	←	√		K/C
RF Out	ON	←	←	√		K/C

List of Default Values
List of Default Values, Save/Recall Settings, and Backup Settings

Key Operation	Factory-shipped Setting	Default Value		Save/ Recall	Backup	Available Means of Defining a Setting
		Presets	*RST			
Sweep Setup						
Sweep Time	AUTO	←	←	√		K/C
Sweep Delay	0.0000 s	←	←	√		K/C
Sweep Mode	Std Stepped	←	←	√		K/C
Points	201	←	←	√		K/C
Sweep Type	Linear	←	←	√		K/C
Edit Segment Table						
Freq Mode	Start/Stop	←	←	√		K/C
List IFBW	OFF	←	←	√		K/C
List Power	OFF	←	←	√		K/C
List Delay	OFF	←	←	√		K/C
List Sweep Mode	OFF	←	←	√		K/C
List Time	OFF	←	←	√		K/C
Segment Display	Order Base	←	←	√		K/C
Frequency Offset						
Frequency Offset	OFF	←	←	√		K/C
Port 1						
Multiplier	1.0000	←	←	√		K/C
Divisor	1.0000	←	←	√		K/C
Offset	0.0000 Hz	←	←	√		K/C
Start	300.00 kHz	←	←	√		K/C
Stop	8.5000 GHz	←	←	√		K/C
Port 2						
Multiplier	1.0000	←	←	√		K/C
Divisor	1.0000	←	←	√		K/C
Offset	0.0000 Hz	←	←	√		K/C
Start	300.00 kHz	←	←	√		K/C
Stop	8.5000 GHz	←	←	√		K/C
Port 3						
Multiplier	1.0000	←	←	√		K/C
Divisor	1.0000	←	←	√		K/C
Offset	0.0000 Hz	←	←	√		K/C
Start	300.00 kHz	←	←	√		K/C
Stop	8.5000 GHz	←	←	√		K/C
Port 4						
Multiplier	1.0000	←	←	√		K/C
Divisor	1.0000	←	←	√		K/C
Offset	0.0000 Hz	←	←	√		K/C
Start	300.00 kHz	←	←	√		K/C
Stop	8.5000 GHz	←	←	√		K/C

List of Default Values

List of Default Values, Save/Recall Settings, and Backup Settings

Key Operation	Factory-shipped Setting	Default Value		Save/ Recall	Backup	Available Means of Defining a Setting
		Preset	*RST			
Sweep Setup						
Frequency Offset						
External Source						
LO Frequency	OFF	←	←	√		K/C
Multiplier	0.0000	←	←	√		K/C
Divisor	1.0000	←	←	√		K/C
Offset	0.0000 Hz	←	←	√		K/C
Start	0.0000 Hz	←	←	√		K/C
Stop	0.0000 Hz	←	←	√		K/C
Control	OFF	←	←	√		K/C
Power	-10 dBm	←	←	√		K/C
Slope [xxdB/GHz]	0 dB/GHz	←	←	√		K/C
Slope [ON/OFF]	OFF	←	←	√		K/C
Avoid Spurious	OFF	←	←	√		K/C
X-Axis	Normal (When Frequency Offset is set off.)	←	←	√		K/C
	Response (When Frequency Offset is set on.)	←	←	√		K/C
Trigger						
Continuous	Continuous (Ch1) Hold (Ch2 to 9)	←	Hold (all channels)	√		K/C
Trigger Source	Internal	←	←	√		K/C
Trigger Event	On Sweep	←	←	√		K/C
Trigger Scope	All Channel	←	←	√		K/C
Ext Trig Delay	0.0000 s	←	←	√		K/C
Low Latency	OFF	←	←	√		K/C
Marker						
Marker 1	Marker 1 is turned on immediately after the marker softkey menu is displayed.	←	←	√		K/C
Ref Marker Mode	OFF	←	←	√		K/C
Marker Search						
Peak						
Peak Excursion	3.0000 dB	←	←	√		K/C
Peak Polarity	Positive	←	←	√		K/C
Target						
Target Value	0.0000 dB (When Target is selected)	←	←	√		K/C
Target Transition	Both (When Target is selected)	←	←	√		K/C
Tracking	OFF	←	←	√		K/C

List of Default Values
List of Default Values, Save/Recall Settings, and Backup Settings

Key Operation	Factory-shipped Setting	Default Value		Save/ Recall	Backup	Available Means of Defining a Setting
		Preset	*RST			
Marker Search						
Search Range						
Search Range	OFF	←	←	√		K/C
Start	0.0000 Hz	←	←	√		K/C
Stop	0.0000 Hz	←	←	√		K/C
Couple	ON	←	←	√		K/C
Bandwidth	OFF	←	←	√		K/C
Bandwidth Value	-3.0000 dB (When one of the marker is on)	←	←	√		K/C
Marker Fctn						
Discrete	OFF	←	←	√		K/C
Couple	ON	←	←	√		K/C
Marker Table	OFF	←	←	√		K/C
Statistics	OFF	←	←	√		K/C
Annotation Options						
Marker Info X Pos	1 %	←	←	√		K/C
Marker Info Y Pos	1 %	←	←	√		K/C
Align	ON	←	←	√		K/C
Active Only	ON	←	←	√		K/C
Analysis						
Fixture Simulator						
Fixture Simulator	OFF	←	←	√		K/C
Topology						
Device	SE-BAL	←	←	√		K/C
Port1 (se)	1 (When SE-Bal is selected as the device) (When SE-SE-Bal is selected as the device)	←	←	√		K/C
Port1 (bal)	1-2 (When Bal-Bal is selected as the device)	←	←	√		K/C
Port2 (bal)	2-3 (SE-Bal is selected as the device) 3-4 (Bal-Bal is selected as the device)	←	←	√		K/C
Port2 (se)	2 (When SE-SE-Bal is selected as the device)	←	←	√		K/C
Port3 (bal)	3-4 (When SE-SE-Bal is selected as the device)	←	←	√		K/C
Property	OFF	←	←	√		K/C

List of Default Values

List of Default Values, Save/Recall Settings, and Backup Settings

Key Operation	Factory-shipped Setting	Default Value		Save/ Recall	Backup	Available Means of Defining a Setting
		Preset	*RST			
Analysis						
Fixture Simulator						
BalUn	OFF	←	←	√		K/C
Port Matching						
Port Matching	OFF	←	←	√		K/C
Select Port	1	←	←	√		K/C
Select Circuit	None	←	←	√		K/C
C	0.000e-12 F	←	←	√		K/C
G	0.0000 S	←	←	√		K/C
L	0.000e-9 H	←	←	√		K/C
R	0.0000 Ω	←	←	√		K/C
Port ZConversion						
Port ZConversion	OFF	←	←	√		K/C
Port1 Z0 Real	50.000 Ω	←	←	√		K/C
Port1 Z0 Imag	0.000 Ω	←	←	√		K/C
Port2 Z0 Real	50.000 Ω	←	←	√		K/C
Port2 Z0 Imag	0.000 Ω	←	←	√		K/C
Port3 Z0 Real	50.000 Ω	←	←	√		K/C
Port3 Z0 Imag	0.000 Ω	←	←	√		K/C
Port4 Z0 Real	50.000 Ω	←	←	√		K/C
Port4 Z0 Imag	0.000 Ω	←	←	√		K/C
De-Embedding						
De-Embedding	OFF	←	←	√		K/C
Select Port	1	←	←	√		K/C
Select Type	None	←	←	√		K/C
Diff Matching						
Diff Matching	OFF	←	←	√		K/C
Select Bal Port	2	←	←	√		K/C
Select Circuit	None	←	←	√		K/C
C	0.000e-12 F	←	←	√		K/C
G	0.0000 S	←	←	√		K/C
L	0.000e-9 H	←	←	√		K/C
R	0.0000 Ω	←	←	√		K/C
Diff ZConversion						
Diff ZConversion	OFF	←	←	√		K/C
Port1 (bal) Real	100.00 Ω	←	←	√		K/C
Port1 (bal) Imag	0.00 Ω	←	←	√		K/C
Port2 (bal) Real	100.00 Ω	←	←	√		K/C
Port2 (bal) Imag	0.00 Ω	←	←	√		K/C

List of Default Values
List of Default Values, Save/Recall Settings, and Backup Settings

Key Operation	Factory-shipped Setting	Default Value		Save/ Recall	Backup	Available Means of Defining a Setting
		Preset	*RST			
Analysis						
Fixture Simulator						
Diff ZConversion						
Port3 (bal) Real	100.00 Ω	←	←	√		K/C
Port3 (bal) Imag	0.00 Ω	←	←	√		K/C
Cmn ZConversion						
Cmn Z Conversion	OFF	←	←	√		K/C
Port1 (bal) Real	25.000 Ω	←	←	√		K/C
Port1 (bal) Imag	0.000 Ω	←	←	√		K/C
Port2 (bal) Real	25.000 Ω	←	←	√		K/C
Port2 (bal) Imag	0.000 Ω	←	←	√		K/C
Port3 (bal) Real	25.000 Ω	←	←	√		K/C
Port3 (bal) Imag	0.000 Ω	←	←	√		K/C
Gating						
Gating	OFF	←	←	√		K/C
Start	-10.000ns	←	←	√		K/C
Stop	10.000ns	←	←	√		K/C
Center	0.0000s	←	←	√		K/C
Span	20.000ns	←	←	√		K/C
Type	Bandpass	←	←	√		K/C
Shape	Normal	←	←	√		K/C
Transform						
Transform	OFF	←	←	√		K/C
Start	-10.000ns	←	←	√		K/C
Stop	10.000ns	←	←	√		K/C
Center	0.0000s	←	←	√		K/C
Span	20.000ns	←	←	√		K/C
Type	Bandpass	←	←	√		K/C
Window	Normal	←	←	√		K/C
Impulse Width	229.55ps	←	←	√		K/C
Kaiser Beta	6.0000	←	←	√		K/C
Conversion						
Conversion	OFF	←	←	√		K/C
Function	Z:Reflection	←	←	√		K/C
Limit Test						
Limit Test	OFF	←	←	√		K/C
Limit Line	OFF	←	←	√		K/C

List of Default Values

List of Default Values, Save/Recall Settings, and Backup Settings

Key Operation	Factory-shipped Setting	Default Value		Save/ Recall	Backup	Available Means of Defining a Setting
		Preset	*RST			
Analysis						
Limit Test						
Limit Line Offsets						
Stimulus Offset	0Hz	←	←	√		K/C
Amplitude Offset	0Hz	←	←	√		K/C
Fail Sign	ON	←	←	√		K/C
Ripple Limit						
Ripple Limit Test	OFF	←	←	√		K/C
Ripple Limit	OFF	←	←	√		K/C
Ripple Value	OFF	←	←	√		K/C
Ripple Band	1	←	←	√		K/C
Fail Sign	ON	←	←	√		K/C
Bandwidth Limit						
BW Test	OFF	←	←	√		K/C
BW Display	OFF	←	←	√		K/C
BW Marker	OFF	←	←	√		K/C
N dB Points	0dB	←	←	√		K/C
Min Bandwidth	0Hz	←	←	√		K/C
Max Bandwidth	0Hz	←	←	√		K/C
Fail Sign	ON	←	←	√		K/C
Macro Setup						
Echo Window	OFF	←	←	√		K/C
Save/Recall						
Save Type	State&Cal	←	←	√		K/C
Channel/Trace	Disp Only	←	←	√		K/C
Save SnP						
SnP Format	Auto	←	←	√		K/C

List of Default Values
List of Default Values, Save/Recall Settings, and Backup Settings

Key Operation	Factory-shipped Setting	Default Value		Save/ Recall	Backup	Available Means of Defining a Setting
		Preset	*RST			
System						
Invert Image	ON	←	←	√		K/C
Multiport Test Set Setup						
Test Set 1						
Select Test Set	E5091_9	←	←	√		K/C
Control	OFF	←	←	√		K/C
Property	OFF	←	←	√		K/C
Port 1	A	←	←	√		K/C
Port 2	T1	←	←	√		K/C
Port 3	R1+	←	←	√		K/C
Port 4	R1-	←	←	√		K/C
Port 5 ^{*1}	X1	←	←	√		K/C
Port 6 ^{*1}	Y1	←	←	√		K/C
Port 7 ^{*1}	Z1	←	←	√		K/C
Control Lines						
Line 1 ... Line 8	LOW	←	←	√		K/C
Test Set 2						
Select Test Set	E5091_9	←	←	√		K/C
Control	OFF	←	←	√		K/C
Property	OFF	←	←	√		K/C
Port 1	A	←	←	√		K/C
Port 2	T1	←	←	√		K/C
Port 3	R1+	←	←	√		K/C
Port 4	R1-	←	←	√		K/C
Port 5 ^{*1}	X1	←	←	√		K/C
Port 6 ^{*1}	Y1	←	←	√		K/C
Port 7 ^{*1}	Z1	←	←	√		K/C
Control Lines						
Line 1 ... Line 8	LOW	←	←	√		K/C

List of Default Values

List of Default Values, Save/Recall Settings, and Backup Settings

Key Operation	Factory-shipped Setting	Default Value		Save/Recall	Backup	Available Means of Defining a Setting
		Preset	*RST			
System						
Misc Setup						
Beeper						
Beep Complete	ON	←	←	√		K/C
Beep Warning	ON	←	←	√		K/C
GPIB Setup						
Talker/Listener Address	17	Non-changing	←		√	K
Power Meter Address	13	Non-changing	←		√	K/C
Signal Generator Address						
Address	19	←	←	√		K/C
Switching Time	100.00 ms	←	←	√		K/C
Custom Commands						
Preset	“”	←	←	√		K/C
Turn RF Out ON	“R3”	←	←	√		K/C
Set Frequency	“FR %f% HZ”	←	←	√		K/C
Set Power Level	“AP %p% DM”	←	←	√		K/C
8643A, 8644B, 8664A, 8665A/B						
8648A/B/C/D, ESG Series, PSG Series	This softkey is selected when instrument is shipped from factory.	←	←	√		K/C
Network Setup						
Telnet Server	OFF	Non-changing	←		√	K
SICL-LAN Server	OFF	Non-changing	←		√	K
SICL-LAN Address	17	Non-changing	←		√	K
Web Server	OFF	Non-changing	←		√	K
Network Device	ENABLE	Non-changing	←		√	K
Clock Setup						
Show Clock	ON	←	←	√		K/C

List of Default Values
List of Default Values, Save/Recall Settings, and Backup Settings

Key Operation	Factory-shipped Setting	Default Value		Save/ Recall	Backup	Available Means of Defining a Setting
		Preset	*RST			
System						
Misc Setup						
Key Lock						
Front Panel & Keyboard Lock	OFF	←	←			K/C
Touch Screen & Mouse Lock	OFF	←	←			K/C
Color Setup						
Normal						
Data Trace 1	Red:5 Green:5 Blue:0	←	←	√		K/C
Data Trace 2	Red:0 Green:5 Blue:5	←	←	√		K/C
Data Trace 3	Red:5 Green:0 Blue:5	←	←	√		K/C
Data Trace 4	Red:0 Green:5 Blue:0	←	←	√		K/C
Data Trace 5	Red:5 Green:4 Blue:0	←	←	√		K/C
Data Trace 6	Red:5 Green:3 Blue:3	←	←	√		K/C
Data Trace 7	Red:3 Green:4 Blue:5	←	←	√		K/C
Data Trace 8	Red:5 Green:4 Blue:4	←	←	√		K/C
Data Trace 9	Red:3 Green:4 Blue:3	←	←	√		K/C
Mem Trace 1	Red:3 Green:3 Blue:0	←	←	√		K/C
Mem Trace 2	Red:0 Green:3 Blue:3	←	←	√		K/C
Mem Trace 3	Red:3 Green:0 Blue:3	←	←	√		K/C
Mem Trace 4	Red:0 Green:3 Blue:0	←	←	√		K/C
Mem Trace 5	Red:3 Green:2 Blue:0	←	←	√		K/C
Mem Trace 6	Red:3 Green:1 Blue:1	←	←	√		K/C
Mem Trace 7	Red:1 Green:2 Blue:3	←	←	√		K/C
Mem Trace 8	Red:3 Green:2 Blue:2	←	←	√		K/C
Mem Trace 9	Red:1 Green:2 Blue:1	←	←	√		K/C
Graticule Main	Red:3 Green:3 Blue:3	←	←	√		K/C
Graticule Sub	Red:1 Green:1 Blue:1	←	←	√		K/C
Limit Fail	Red:5 Green:0 Blue:0	←	←	√		K/C
Limit Line	Red:3 Green:0 Blue:0	←	←	√		K/C
Background	Red:0 Green:0 Blue:0	←	←	√		K/C
Channel/Trace Setup	9 Channels 9 Traces	Non-changing	←		√	K
Preset Setup						
State	Factory	Non-changing	←		√	K
Confirm	ON	Non-changing	←		√	K

List of Default Values

List of Default Values, Save/Recall Settings, and Backup Settings

Key Operation	Factory-shipped Setting	Default Value		Save/ Recall	Backup	Available Means of Defining a Setting
		Preset	*RST			
System						
Backlight	ON	←	←			K/C
Service Menu						
System Correction	ON	←	←	√		K/C
Avoid Spurious	ON	←	←	√		K/C
High Temperature	OFF	Non-changing	←	√		K/C
Init Src Ctrl	ON	←	←	√		K/C
Init Src Port	Port 1	←	←	√		K/C
Security Level	None	←	←	√		K/C

*1. Only when the E5091A-016 is selected.

D **Softkey Functions**

This appendix explains the functions of softkeys and hardkeys supplied on the Agilent E5070B/E5071B.

E5070B/E5071B Menu (Top Menu)

Key Operation	Function
Double-click on each softkey menu title	Displays the top menu of each menu item below. A preset operation will not cancel the menu display.
Measurement	Same as Meas . See “Measurement Menu” on page 701.
Format	Same as Format . See “Format Menu” on page 692.
Scale	Same as Scale . See “Scale Menu” on page 713.
Display	Same as Display . See “Display Menu” on page 688.
Average	Same as Avg . See “Average Menu” on page 662.
Calibration	Same as Cal . See “Calibration Menu” on page 663.
Stimulus	Displays the same softkey for setting up the sweep range that appears when Start , Stop , Center , or Span is pressed. See “Stimulus Menu” on page 714.
Sweep Setup	Same as Sweep Setup . See “Sweep Setup Menu” on page 715.
Trigger	Same as Trigger . See “Trigger Menu” on page 725.
Marker	Same as Marker . See “Marker Menu” on page 695.
Marker Search	Same as Marker Search . See “Marker Search Menu” on page 698.
Marker Function	Same as Marker Fctn . See “Marker Function Menu” on page 697.
Analysis	Same as Analysis . See “Analysis Menu” on page 647.
Macro Setup	Same as Macro Setup . See “Macro Setup Menu” on page 693.
Save/Recall	Same as Save/Recall . See “Save/Recall Menu” on page 709.
System	Same as System . See “System Menu” on page 718.
Preset	Same as Preset . See “Preset Menu” on page 708.

Analysis Menu

Key Operation	Function	SCPI Command
Analysis	Displays softkeys for performing analysis functions.	
Fixture Simulator	Displays softkeys for setting up fixture simulator functions. The fixture simulator is software that uses measurement results to simulate various measurement conditions. The fixture simulator consists of the following six functions: balanced/unbalanced conversion (use Topology and BalUn to set up), matching circuit (use Port Matching), port impedance conversion (use Port Z Conversion), network de-embedding (use De-Embedding), differential matching circuit (use Diff. Matching), and differential impedance conversion (use Diff. Z Conversion). To use each of the above functions, each must be enabled at the same time you enable the fixture simulator using the Fixture Simulator key below.	
Fixture Simulator	Enables or disables the fixture simulator function. When using one or more of the six functions provided with the fixture simulator, the fixture simulator function must be enabled using this key along with all desired functions.	:CALC{1-16}:FSIM:STAT
Topology *1	Displays softkeys for setting the balanced measurement topology (the types of DUT ports and the connecting method to test the ports).	
Device	Displays softkeys for selecting the types of DUT ports in a balanced measurement.	
SE-Bal	Evaluates mixed mode S parameters between a single-end (unbalanced) port and balanced port on the DUT. In the succeeding procedure, the single-end port and the balanced port will be treated as port 1 on the DUT (logical port 1) and port 2 on the DUT (logical port 2), respectively.	:CALC{1-16}:FSIM:BAL:DEV SBAL
Bal-Bal *2	Evaluates mixed mode S parameters between two balanced ports on the DUT. In the succeeding procedure, the two balanced ports will be treated as port 1 on the DUT (logical port 1) and port 2 on the DUT (logical port 2).	:CALC{1-16}:FSIM:BAL:DEV BBAL
SE-SE-Bal *2	Evaluates mixed mode S parameters between two single-end (unbalanced) ports and balanced port on the DUT. In the succeeding procedure, the two single-end ports will be treated as port 1 on the DUT (logical port 1) and port 2 on the DUT (logical port 2), and the balanced port as port 3 on the DUT (logical port 3).	:CALC{1-16}:FSIM:BAL:DEV SSB
Cancel	Returns to the softkey display screen one level higher.	
Port1 (se)	Displays softkeys for selecting the analyzer port (test port) to which (single-end) port 1 on the DUT will be connected. This key will be displayed only when SE-Bal or SE-SE-Bal in the Device menu is selected.	
1	Selects test port 1 on the analyzer for connection with (single-end) port 1 on the DUT.	:CALC{1-16}:FSIM:BAL:TOP:SBAL :CALC{1-16}:FSIM:BAL:TOP:SSB
2	Selects test port 2 on the analyzer for connection with (single-end) port 1 on the DUT.	:CALC{1-16}:FSIM:BAL:TOP:SBAL :CALC{1-16}:FSIM:BAL:TOP:SSB
3	Selects test port 3 on the analyzer for connection with (single-end) port 1 on the DUT.	:CALC{1-16}:FSIM:BAL:TOP:SBAL :CALC{1-16}:FSIM:BAL:TOP:SSB
4 *2	Selects test port 4 on the analyzer for connection with (single-end) port 1 on the DUT.	:CALC{1-16}:FSIM:BAL:TOP:SBAL :CALC{1-16}:FSIM:BAL:TOP:SSB
Cancel	Returns to the softkey display screen one level higher.	
Port1 (bal) *2	Displays softkeys for selecting the analyzer ports (test ports) to which (balanced) port 1 on the DUT will be connected. This key will be displayed only when Bal-Bal in the Device menu is selected.	
1-2	Selects test ports 1 and 2 on the analyzer for connection with (balanced) port 1 on the DUT (ports a and b in Table 7-8 on page 294) respectively.	:CALC{1-16}:FSIM:BAL:TOP:BBAL
1-3	Selects test ports 1 and 3 on the analyzer for connection with (balanced) port 1 on the DUT (ports a and b in Table 7-8 on page 294) respectively.	:CALC{1-16}:FSIM:BAL:TOP:BBAL
1-4	Selects test ports 1 and 4 on the analyzer for connection with (balanced) port 1 on the DUT (ports a and b in Table 7-8 on page 294) respectively.	:CALC{1-16}:FSIM:BAL:TOP:BBAL
2-1	Selects test ports 2 and 1 on the analyzer for connection with (balanced) port 1 on the DUT (ports a and b in Table 7-8 on page 294) respectively.	:CALC{1-16}:FSIM:BAL:TOP:BBAL

Softkey Functions Analysis Menu

Key Operation	Function	SCPI Command
Analysis	(Continued)	
Fixture Simulator		
Topology ^{*1}		
Port1 (bal) ^{*2}		
2-3	Selects test ports 2 and 3 on the analyzer for connection with (balanced) port 1 on the DUT (ports a and b in Table 7-8 on page 294) respectively.	:CALC{1-16}:FSIM:BAL:TOP:BBAL
2-4	Selects test ports 2 and 4 on the analyzer for connection with (balanced) port 1 on the DUT (ports a and b in Table 7-8 on page 294) respectively.	:CALC{1-16}:FSIM:BAL:TOP:BBAL
3-1	Selects test ports 3 and 1 on the analyzer for connection with (balanced) port 1 on the DUT (ports a and b in Table 7-8 on page 294) respectively.	:CALC{1-16}:FSIM:BAL:TOP:BBAL
3-2	Selects test ports 3 and 2 on the analyzer for connection with (balanced) port 1 on the DUT (ports a and b in Table 7-8 on page 294) respectively.	:CALC{1-16}:FSIM:BAL:TOP:BBAL
3-4	Selects test ports 3 and 4 on the analyzer for connection with (balanced) port 1 on the DUT (ports a and b in Table 7-8 on page 294) respectively.	:CALC{1-16}:FSIM:BAL:TOP:BBAL
4-1	Selects test ports 4 and 1 on the analyzer for connection with (balanced) port 1 on the DUT (ports a and b in Table 7-8 on page 294) respectively.	:CALC{1-16}:FSIM:BAL:TOP:BBAL
4-2	Selects test ports 4 and 2 on the analyzer for connection with (balanced) port 1 on the DUT (ports a and b in Table 7-8 on page 294) respectively.	:CALC{1-16}:FSIM:BAL:TOP:BBAL
Cancel	Returns to the softkey display screen one level higher.	
4-3	Selects test ports 4 and 3 on the analyzer for connection with (balanced) port 1 on the DUT (ports a and b in Table 7-8 on page 294) respectively.	:CALC{1-16}:FSIM:BAL:TOP:BBAL
Port2 (bal)	Displays softkeys for selecting the analyzer ports (test ports) to which (balanced) port 2 on the DUT will be connected. This key will be displayed only when SE-Bal or Bal-Bal in the Device menu is selected.	
1-2	Selects test ports 1 and 2 on the analyzer for connection with (balanced) port 2 on the DUT (ports b and c for SE-Bal or ports c and d for Bal-Bal in Table 7-8 on page 294) respectively.	:CALC{1-16}:FSIM:BAL:TOP:BBAL :CALC{1-16}:FSIM:BAL:TOP:SBAL
1-3	Selects test ports 1 and 3 on the analyzer for connection with (balanced) port 2 on the DUT (ports b and c for SE-Bal or ports c and d for Bal-Bal in Table 7-8 on page 294) respectively.	:CALC{1-16}:FSIM:BAL:TOP:BBAL :CALC{1-16}:FSIM:BAL:TOP:SBAL
1-4 ^{*2}	Selects test ports 1 and 4 on the analyzer for connection with (balanced) port 2 on the DUT (ports b and c for SE-Bal or ports c and d for Bal-Bal in Table 7-8 on page 294) respectively.	:CALC{1-16}:FSIM:BAL:TOP:BBAL :CALC{1-16}:FSIM:BAL:TOP:SBAL
2-1	Selects test ports 2 and 1 on the analyzer for connection with (balanced) port 2 on the DUT (ports b and c for SE-Bal or ports c and d for Bal-Bal in Table 7-8 on page 294) respectively.	:CALC{1-16}:FSIM:BAL:TOP:BBAL :CALC{1-16}:FSIM:BAL:TOP:SBAL
2-3	Selects test ports 2 and 3 on the analyzer for connection with (balanced) port 2 on the DUT (ports b and c for SE-Bal or ports c and d for Bal-Bal in Table 7-8 on page 294) respectively.	:CALC{1-16}:FSIM:BAL:TOP:BBAL :CALC{1-16}:FSIM:BAL:TOP:SBAL
2-4 ^{*2}	Selects test ports 2 and 4 on the analyzer for connection with (balanced) port 2 on the DUT (ports b and c for SE-Bal or ports c and d for Bal-Bal in Table 7-8 on page 294) respectively.	:CALC{1-16}:FSIM:BAL:TOP:BBAL :CALC{1-16}:FSIM:BAL:TOP:SBAL
3-1	Selects test ports 3 and 1 on the analyzer for connection with (balanced) port 2 on the DUT (ports b and c for SE-Bal or ports c and d for Bal-Bal in Table 7-8 on page 294) respectively.	:CALC{1-16}:FSIM:BAL:TOP:BBAL :CALC{1-16}:FSIM:BAL:TOP:SBAL
3-2	Selects test ports 3 and 2 on the analyzer for connection with (balanced) port 2 on the DUT (ports b and c for SE-Bal or ports c and d for Bal-Bal in Table 7-8 on page 294) respectively.	:CALC{1-16}:FSIM:BAL:TOP:BBAL :CALC{1-16}:FSIM:BAL:TOP:SBAL
3-4 ^{*2}	Selects test ports 3 and 4 on the analyzer for connection with (balanced) port 2 on the DUT (ports b and c for SE-Bal or ports c and d for Bal-Bal in Table 7-8 on page 294) respectively.	:CALC{1-16}:FSIM:BAL:TOP:BBAL :CALC{1-16}:FSIM:BAL:TOP:SBAL

Key Operation	Function	SCPI Command
Analysis	(Continued)	
Fixture Simulator		
Topology *1		
Port2 (bal)		
4-1 *2	Selects test ports 4 and 1 on the analyzer for connection with (balanced) port 2 on the DUT (ports b and c for SE-Bal or ports c and d for Bal-Bal in Table 7-8 on page 294) respectively.	:CALC{1-16}:FSIM:BAL:TOP:BBAL :CALC{1-16}:FSIM:BAL:TOP:SBAL
4-2 *2	Selects test ports 4 and 2 on the analyzer for connection with (balanced) port 2 on the DUT (ports b and c for SE-Bal or ports c and d for Bal-Bal in Table 7-8 on page 294) respectively.	:CALC{1-16}:FSIM:BAL:TOP:BBAL :CALC{1-16}:FSIM:BAL:TOP:SBAL
4-3 *2	Selects test ports 4 and 3 on the analyzer for connection with (balanced) port 2 on the DUT (ports b and c for SE-Bal or ports c and d for Bal-Bal in Table 7-8 on page 294) respectively.	:CALC{1-16}:FSIM:BAL:TOP:BBAL :CALC{1-16}:FSIM:BAL:TOP:SBAL
Cancel	Returns to the softkey display screen one level higher.	
Port2 (se) *2	Displays softkeys for selecting the analyzer port (test port) to which (single-end) port 2 on the DUT will be connected. This key will be displayed only when SE-SE-Bal in the Device menu is selected.	
1	Selects test port 1 on the analyzer for connection with (single-end) port 2 on the DUT.	:CALC{1-16}:FSIM:BAL:TOP:SSB
2	Selects test port 2 on the analyzer for connection with (single-end) port 2 on the DUT.	:CALC{1-16}:FSIM:BAL:TOP:SSB
3	Selects test port 3 on the analyzer for connection with (single-end) port 2 on the DUT.	:CALC{1-16}:FSIM:BAL:TOP:SSB
4	Selects test port 4 on the analyzer for connection with (single-end) port 2 on the DUT.	:CALC{1-16}:FSIM:BAL:TOP:SSB
Cancel	Returns to the softkey display screen one level higher.	
Port3 (bal) *2	Displays softkeys for selecting the analyzer ports (test ports) to which (balanced) port 3 on the DUT will be connected. This key will be displayed only when SE-SE-Bal in the Device menu is selected.	
1-2	Selects test ports 1 and 2 on the analyzer for connection with (balanced) port 3 on the DUT (ports c and d in Table 7-8 on page 294) respectively.	:CALC{1-16}:FSIM:BAL:TOP:SSB
1-3	Selects test ports 1 and 3 on the analyzer for connection with (balanced) port 3 on the DUT (ports c and d in Table 7-8 on page 294) respectively.	:CALC{1-16}:FSIM:BAL:TOP:SSB
1-4	Selects test ports 1 and 4 on the analyzer for connection with (balanced) port 3 on the DUT (ports c and d in Table 7-8 on page 294) respectively.	:CALC{1-16}:FSIM:BAL:TOP:SSB
2-1	Selects test ports 2 and 1 on the analyzer for connection with (balanced) port 3 on the DUT (ports c and d in Table 7-8 on page 294) respectively.	:CALC{1-16}:FSIM:BAL:TOP:SSB
2-3	Selects test ports 2 and 3 on the analyzer for connection with (balanced) port 3 on the DUT (ports c and d in Table 7-8 on page 294) respectively.	:CALC{1-16}:FSIM:BAL:TOP:SSB
2-4	Selects test ports 2 and 4 on the analyzer for connection with (balanced) port 3 on the DUT (ports c and d in Table 7-8 on page 294) respectively.	:CALC{1-16}:FSIM:BAL:TOP:SSB
3-1	Selects test ports 3 and 1 on the analyzer for connection with (balanced) port 3 on the DUT (ports c and d in Table 7-8 on page 294) respectively.	:CALC{1-16}:FSIM:BAL:TOP:SSB
3-2	Selects test ports 3 and 2 on the analyzer for connection with (balanced) port 3 on the DUT (ports c and d in Table 7-8 on page 294) respectively.	:CALC{1-16}:FSIM:BAL:TOP:SSB
3-4	Selects test ports 3 and 4 on the analyzer for connection with (balanced) port 3 on the DUT (ports c and d in Table 7-8 on page 294) respectively.	:CALC{1-16}:FSIM:BAL:TOP:SSB
4-1	Selects test ports 4 and 1 on the analyzer for connection with (balanced) port 3 on the DUT (ports c and d in Table 7-8 on page 294) respectively.	:CALC{1-16}:FSIM:BAL:TOP:SSB
4-2	Selects test ports 4 and 2 on the analyzer for connection with (balanced) port 3 on the DUT (ports c and d in Table 7-8 on page 294) respectively.	:CALC{1-16}:FSIM:BAL:TOP:SSB

Softkey Functions
Analysis Menu

Key Operation	Function	SCPI Command
Analysis	(Continued)	
Fixture Simulator		
Topology ^{*1}		
Port3 (bal) ^{*2}		
4-3	Selects test ports 4 and 3 on the analyzer for connection with (balanced) port 3 on the DUT (ports c and d in Table 7-8 on page 294) respectively.	:CALC{1-16}:FSIM:BAL:TOP:SSB
Cancel	Returns to the softkey display screen one level higher.	
Property	Enables or disables the display of the balanced measurement topology property. When enabled, calibration status information between test ports will be displayed in a matrix format in the lower-right corner of the channel window.	:CALC{1-16}:FSIM:BAL:TOP:PROP:STAT
Return	Returns to the softkey display screen one level higher.	
BalUn ^{*1}	Enables or disables the balanced/unbalanced conversion function of active trace. This function uses internal software to convert the results obtained from an unbalanced test port on the E5070B/E5071B into characteristics of a balanced port. The port converted into a balanced port will be characterized by a common mode signal and a differential mode signal. Measurement parameters are expressed as mixed mode S parameters. Use the Topology to select the type of DUT port and the connection method to test the ports.	:CALC{1-16}:FSIM:BAL:PAR{1-16}:STAT
Balun OFF All Traces ^{*1}	Disables the balanced/unbalanced conversion function of all displayed traces.	None
Balun ON All Traces ^{*1}	Enables the balanced/unbalanced conversion function of all displayed traces.	None
Measurement	Same as Meas . See “Measurement Menu” on page 701.	
Port Matching	Displays softkeys for setting up the matching circuit function. Based on the measurement results, the matching circuit function uses internal software to determine characteristics with a matching circuit inserted between the DUT and the test ports.	
Port Matching	Enables or disables the matching circuit function.	:CALC{1-16}:FSIM:SEND:PMC:STAT
Select Port	Displays softkeys for selecting the test port to which a matching circuit is added.	
1	Selects test port 1 for adding a matching circuit.	:CALC{1-16}:FSIM:SEND:PMC:PORT1
2	Selects test port 2 for adding a matching circuit.	:CALC{1-16}:FSIM:SEND:PMC:PORT2
3 ^{*1}	Selects test port 3 for adding a matching circuit.	:CALC{1-16}:FSIM:SEND:PMC:PORT3
4 ^{*2}	Selects test port 4 for adding a matching circuit.	:CALC{1-16}:FSIM:SEND:PMC:PORT4
Cancel	Returns to the softkey display screen one level higher.	
Select Circuit	Displays softkeys for selecting the type of matching circuit to be added.	
None	Does not add any matching circuit to the port selected in the Select Port menu.	:CALC{1-16}:FSIM:SEND:PMC:PORT{1-4} NONE
SeriesL - ShuntC	Adds a series L - shunt C type matching circuit to the port selected in the Select Port menu.	:CALC{1-16}:FSIM:SEND:PMC:PORT{1-4} SLPC
ShuntC - SeriesL	Adds a shunt C - series L type matching circuit to the port selected in the Select Port menu.	:CALC{1-16}:FSIM:SEND:PMC:PORT{1-4} PCSL
ShuntL - SeriesC	Adds a shunt L - series C type matching circuit to the port selected in the Select Port menu.	:CALC{1-16}:FSIM:SEND:PMC:PORT{1-4} PLSC
SeriesC - ShuntL	Adds a series C - shunt L type matching circuit to the port selected in the Select Port menu.	:CALC{1-16}:FSIM:SEND:PMC:PORT{1-4} SCPL

Key Operation	Function	SCPI Command
Analysis	(Continued)	
Fixture Simulator		
Port Matching		
Select Circuit		
ShuntL - ShuntC	Adds a shunt L - shunt C type matching circuit to the port selected in the Select Port menu.	:CALC{1-16}:FSIM:SEND:PMC:PORT{1-4}:PLPC
User	Adds a user-defined matching circuit to the port selected in the Select Port menu. The user-defined matching circuit must be prepared in the 2-port Touchstone data format and loaded onto the E5070B/E5071B from the User File menu.	:CALC{1-16}:FSIM:SEND:PMC:PORT{1-4}:USER
Cancel	Returns to the softkey display screen one level higher.	
C	Sets the value of C for the matching circuit selected in the Select Circuit menu for addition to the port selected in the Select Port menu.	:CALC{1-16}:FSIM:SEND:PMC:PORT{1-4}:PAR:C
G	Sets the value of G for the matching circuit selected in the Select Circuit menu for addition to the port selected in the Select Port menu.	:CALC{1-16}:FSIM:SEND:PMC:PORT{1-4}:PAR:G
L	Sets the value of L for the matching circuit selected in the Select Circuit menu for addition to the port selected in the Select Port menu.	:CALC{1-16}:FSIM:SEND:PMC:PORT{1-4}:PAR:L
R	Sets the value of R for the matching circuit selected in the Select Circuit menu for addition to the port selected in the Select Port menu.	:CALC{1-16}:FSIM:SEND:PMC:PORT{1-4}:PAR:R
User File	Opens a dialog box for loading a user-defined 2-port Touchstone data file. The loaded matching circuit can be added to ports by selecting User in the Select Circuit menu.	:CALC{1-16}:FSIM:SEND:PMC:PORT{1-4}:USER:FILE
Return	Returns to the softkey display screen one level higher.	
Port ZConversion	Displays softkeys for setting up the port impedance conversion function. This function is included in internal software that converts S parameters determined with a 50 W reference port impedance to S parameters for arbitrary port impedance.	
Port ZConversion	Enables or disables the port impedance conversion function.	:CALC{1-16}:FSIM:SEND:ZCON:STAT
Port 1 Z0 Real	Sets the reference impedance (real format) of port 1.	:CALC{1-16}:FSIM:SEND:ZCON:PORT1:Z0 :CALC{1-16}:FSIM:SEND:ZCON:PORT1:REAL
Port 1 Z0 Imag	Sets the reference impedance (complex format) of port 1.	:CALC{1-16}:FSIM:SEND:ZCON:PORT1:IMAG
Port 2 Z0 Real	Sets the reference impedance (real format) of port 2.	:CALC{1-16}:FSIM:SEND:ZCON:PORT2:Z0 :CALC{1-16}:FSIM:SEND:ZCON:PORT2:REAL
Port 2 Z0 Imag	Sets the reference impedance (complex format) of port 2.	:CALC{1-16}:FSIM:SEND:ZCON:PORT2:IMAG
Port 3 Z0 Real*1	Sets the reference impedance (real format) of port 3.	:CALC{1-16}:FSIM:SEND:ZCON:PORT3:Z0 :CALC{1-16}:FSIM:SEND:ZCON:PORT3:REAL
Port 3 Z0 Imag*1	Sets the reference impedance (complex format) of port 3.	:CALC{1-16}:FSIM:SEND:ZCON:PORT3:IMAG
Port 4 Z0 Real*2	Sets the reference impedance (real format) of port 4.	:CALC{1-16}:FSIM:SEND:ZCON:PORT4:Z0 :CALC{1-16}:FSIM:SEND:ZCON:PORT4:REAL
Port 4 Z0 Imag*2	Sets the reference impedance (complex format) of port 4.	:CALC{1-16}:FSIM:SEND:ZCON:PORT4:IMAG
Return	Returns to the softkey display screen one level higher.	

Softkey Functions Analysis Menu

Key Operation	Function	SCPI Command
Analysis	(Continued)	
Fixture Simulator		
De-Embedding	Displays softkeys for setting up the network de-embedding function. Network de-embedding is a function used to eliminate any user-defined network (with a reference impedance of 50 W) supplied in a 2-port Touchstone data file, from desired test ports to extend the calibration plane.	
De-Embedding	Enables or disables the network de-embedding function.	:CALC{1-16}:FSIM:SEND:DEEM:STAT
Select Port	Displays softkeys for selecting test ports for which network de-embedding will be performed.	
1	Selects test port 1 for performing network de-embedding.	:CALC{1-16}:FSIM:SEND:DEEM:PORT1
2	Selects test port 2 for performing network de-embedding.	:CALC{1-16}:FSIM:SEND:DEEM:PORT2
3*1	Selects test port 3 for performing network de-embedding.	:CALC{1-16}:FSIM:SEND:DEEM:PORT3
4*2	Selects test port 4 for performing network de-embedding.	:CALC{1-16}:FSIM:SEND:DEEM:PORT4
Cancel	Returns to the softkey display screen one level higher.	
Select Type	Displays softkeys for selecting the type of network de-embedding to be performed on the test port selected in the Select Port menu.	
None	Does not allow network de-embedding on the test port selected in the Select Port menu.	:CALC{1-16}:FSIM:SEND:DEEM:PORT{1-4} NONE
User	De-embeds a user-defined network from the test port selected in the Select Port menu. The user-defined network should be prepared in the 2-port Touchstone data format and loaded onto the E5070B/E5071B from the User File menu.	:CALC{1-16}:FSIM:SEND:DEEM:PORT{1-4} USER
Cancel	Returns to the softkey display screen one level higher.	
User File	Opens a dialog box for reading a 2-port Touchstone data file prepared by the user. Selecting User in the Select Type menu will de-embed the loaded network.	:CALC{1-16}:FSIM:SEND:DEEM:PORT{1-4}:USER:FILE
Return	Returns to the softkey display screen one level higher.	
Diff Matching*1	Displays softkeys for setting up the differential matching circuit function. This function uses internal software to convert the characteristics of a balanced port to those with an inserted differential matching circuit.	
Diff. Matching	Enables or disables the differential matching circuit function.	:CALC{1-16}:FSIM:BAL:DMC:STAT
Select Bal Port	Displays softkeys for selecting a balanced port to which a differential matching circuit will be added.	
1*2	Selects port 1 on the DUT for adding a differential matching circuit.	:CALC{1-16}:FSIM:BAL:DMC:BPOR1
2	Selects port 2 on the DUT for adding a differential matching circuit.	:CALC{1-16}:FSIM:BAL:DMC:BPOR{1-2}
3*2	Selects port 3 on the DUT for adding a differential matching circuit.	:CALC{1-16}:FSIM:BAL:DMC:BPOR1
Cancel	Returns to the softkey display screen one level higher.	
Select Circuit	Displays softkeys for selecting the type of differential matching circuit.	
None	Does not allow a differential matching circuit to be added to the balanced port selected in the Select Bal Port menu.	:CALC{1-16}:FSIM:BAL:DMC:BPOR{1-2} NONE
ShuntL - ShuntC	Adds a shunt L - shunt C type differential matching circuit to the port selected in the Select Bal Port menu.	:CALC{1-16}:FSIM:BAL:DMC:BPOR{1-2} PLPC
User	Adds a user-defined differential matching circuit to the port selected in the Select Bal Port menu. The user-defined differential matching circuit should be provided in the 2-port Touchstone data format and loaded onto the E5070B/E5071B from the User File menu.	:CALC{1-16}:FSIM:BAL:DMC:BPOR{1-2} USER
Cancel	Returns to the softkey display screen one level higher.	

Key Operation	Function	SCPI Command
Analysis	(Continued)	
Fixture Simulator		
Diff Matching ^{*1}		
C	Sets the value of C for the shunt L - shunt C differential matching circuit to be added to the balanced port selected in the Select Bal Port menu.	:CALC{1-16}:FSIM:BAL:DMC:BPOR{1-2}:PAR:C
G	Sets the value of G for the shunt L - shunt C differential matching circuit to be added to the balanced port selected in the Select Bal Port menu.	:CALC{1-16}:FSIM:BAL:DMC:BPOR{1-2}:PAR:G
L	Sets the value of L for the shunt L - shunt C differential matching circuit to be added to the balanced port selected in the Select Bal Port menu.	:CALC{1-16}:FSIM:BAL:DMC:BPOR{1-2}:PAR:L
R	Sets the value of R for the shunt L - shunt C differential matching circuit to be added to the balanced port selected in the Select Bal Port menu.	:CALC{1-16}:FSIM:BAL:DMC:BPOR{1-2}:PAR:R
User File	Opens a dialog box for reading a 2-port Touchstone data file prepared by the user. Selecting User in the Select Circuit menu adds the loaded differential matching circuit.	:CALC{1-16}:FSIM:BAL:DMC:BPOR{1-2}:USER:FIL
Return	Returns to the softkey display screen one level higher.	
Diff ZConversion ^{*1}	Displays softkeys for setting up the differential impedance conversion function. When the reference impedance of two unbalanced ports is expressed as Z_0 , an automatic conversion sets the differential mode reference impedance of the converted balanced port to $2Z_0$ and the common mode reference impedance to $Z_0/2$. Differential impedance conversion is a function that further converts $2Z_0$ into another reference impedance.	
Diff ZConversion	Enables or disables the differential impedance conversion function.	:CALC{1-16}:FSIM:BAL:DZC:STAT
Port1 (bal) Real ^{*2}	Sets the differential reference impedance (real format) of balanced port 1.	:CALC{1-16}:FSIM:BAL:DZC:BPOR1:Z0 :CALC{1-16}:FSIM:BAL:DZC:BPOR1:REAL
Port1 (bal) Imag ^{*2}	Sets the differential reference impedance (complex format) of balanced port 1.	:CALC{1-16}:FSIM:BAL:DZC:BPOR1:IMAG
Port2 (bal) Real	Sets the differential reference impedance (real format) of balanced port 2.	:CALC{1-16}:FSIM:BAL:DZC:BPOR{1-2}:Z0 :CALC{1-16}:FSIM:BAL:DZC:BPOR{1-2}:REAL
Port2 (bal) Imag	Sets the differential reference impedance (complex format) of balanced port 2.	:CALC{1-16}:FSIM:BAL:DZC:BPOR{1-2}:IMAG
Port3 (bal) Real ^{*2}	Sets the differential reference impedance (real format) of balanced port 3.	:CALC{1-16}:FSIM:BAL:DZC:BPOR1:Z0 :CALC{1-16}:FSIM:BAL:DZC:BPOR1:REAL
Port3 (bal) Imag ^{*2}	Sets the differential reference impedance (complex format) of balanced port 3.	:CALC{1-16}:FSIM:BAL:DZC:BPOR1:IMAG
Return	Returns to the softkey display screen one level higher.	
Return	Returns to the softkey display screen one level higher.	

Softkey Functions
Analysis Menu

Key Operation	Function	SCPI Command
Analysis	(Continued)	
Fixture Simulator		
Cmn ZConversion *1	Displays softkeys for setting up the common impedance conversion function. When the reference impedance of two unbalanced ports is expressed as Z_0 , an automatic conversion sets the differential mode reference impedance of the converted balanced port to $2Z_0$ and the common mode reference impedance to $Z_0/2$. Common impedance conversion is a function that further converts $Z_0/2$ into another reference impedance.	
Cmn ZConversion	Enables or disables the common impedance conversion function.	:CALC{1-16}:FSIM:BAL:CZC:STAT
Port1 (bal) Real *2	Sets the common reference impedance (real format) of balanced port 1.	:CALC{1-16}:FSIM:BAL:CZC:BPOR1:Z0 :CALC{1-16}:FSIM:BAL:CZC:BPOR1:REAL
Port1 (bal) Imag *2	Sets the common reference impedance (complex format) of balanced port 1.	:CALC{1-16}:FSIM:BAL:CZC:BPOR1:IMAG
Port2 (bal) Real	Sets the common reference impedance (real format) of balanced port 2.	:CALC{1-16}:FSIM:BAL:CZC:BPOR{1-2}:Z0 :CALC{1-16}:FSIM:BAL:CZC:BPOR{1-2}:REAL
Port2 (bal) Imag	Sets the common reference impedance (complex format) of balanced port 2.	:CALC{1-16}:FSIM:BAL:CZC:BPOR{1-2}:IMAG
Port3 (bal) Real *2	Sets the common reference impedance (real format) of balanced port 3.	:CALC{1-16}:FSIM:BAL:CZC:BPOR1:Z0 :CALC{1-16}:FSIM:BAL:CZC:BPOR1:REAL
Port3 (bal) Imag *2	Sets the common reference impedance (complex format) of balanced port 3.	:CALC{1-16}:FSIM:BAL:CZC:BPOR1:IMAG
Return	Returns to the softkey display screen one level higher.	
De-Embedding S4P	Displays the softkey to make the setting of the 4-port network embedding/de-embedding feature. The 4-port network embedding/de-embedding feature is the feature to embed or de-embed your desired network that you have defined in a 4-port touchstone data file.	
De-Embedding S4P	Toggles ON/OFF the 4-port network embedding/de-embedding feature.	:CALC{1-16}:FSIM:EMB:STAT
Topology	Displays the softkey to assign a topology (the connection method between the analyzer and the DUT).	
Select Topology	Displays the softkey to select the type of the topology (see Figure 7-6).	
A	Selects topology A (connecting the 2 ports of the analyzer and the DUT).	:CALC{1-16}:FSIM:EMB:TYPE A
B *1	Selects topology B (connecting the 2 ports of the analyzer and the DUT).	:CALC{1-16}:FSIM:EMB:TYPE B
C *2	Selects topology C (connecting the 2 ports of the analyzer and the DUT).	:CALC{1-16}:FSIM:EMB:TYPE C
Cancel	Returns to the softkey display screen one level higher.	
Ports *1	Displays the softkey to select a port of the analyzer (test port) that you want to connect to the DUT. (When you select A on the Select Topology menu.)	
1-2	Sets the ports of the analyzer connected to ports a and b in Figure 7-6 to test ports 1 and 2, respectively.	:CALC{1-16}:FSIM:EMB:TOP:A:PORT 1,2
1-3 *1	Sets the ports of the analyzer connected to ports a and b in Figure 7-6 to test ports 1 and 3, respectively.	:CALC{1-16}:FSIM:EMB:TOP:A:PORT 1,3
1-4 *2	Sets the ports of the analyzer connected to ports a and b in Figure 7-6 to test ports 1 and 4, respectively.	:CALC{1-16}:FSIM:EMB:TOP:A:PORT 1,4
2-1	Sets the ports of the analyzer connected to ports a and b in Figure 7-6 to test ports 2 and 1, respectively.	:CALC{1-16}:FSIM:EMB:TOP:A:PORT 2,1
2-3 *1	Sets the ports of the analyzer connected to ports a and b in Figure 7-6 to test ports 2 and 3, respectively.	:CALC{1-16}:FSIM:EMB:TOP:A:PORT 2,3

Key Operation	Function	SCPI Command
Analysis	(Continued)	
Fixture Simulator		
De-Embedding S4P		
Topology		
Ports		
2-4*2	Sets the ports of the analyzer connected to ports a and b in Figure 7-6 to test ports 2 and 4, respectively.	:CALC{1-16}:FSIM:EMB:TOP:A:PORT 2,4
3-1*1	Sets the ports of the analyzer connected to ports a and b in Figure 7-6 to test ports 3 and 1, respectively.	:CALC{1-16}:FSIM:EMB:TOP:A:PORT 3,1
3-2*1	Sets the ports of the analyzer connected to ports a and b in Figure 7-6 to test ports 3 and 2, respectively.	:CALC{1-16}:FSIM:EMB:TOP:A:PORT 3,2
3-4*2	Sets the ports of the analyzer connected to ports a and b in Figure 7-6 to test ports 3 and 4, respectively.	:CALC{1-16}:FSIM:EMB:TOP:A:PORT 3,4
4-1*2	Sets the ports of the analyzer connected to ports a and b in Figure 7-6 to test ports 4 and 1, respectively.	:CALC{1-16}:FSIM:EMB:TOP:A:PORT 4,1
4-2*2	Sets the ports of the analyzer connected to ports a and b in Figure 7-6 to test ports 4 and 2, respectively.	:CALC{1-16}:FSIM:EMB:TOP:A:PORT 4,2
4-3*2	Sets the ports of the analyzer connected to ports a and b in Figure 7-6 to test ports 4 and 3, respectively.	:CALC{1-16}:FSIM:EMB:TOP:A:PORT 4,3
Cancel	Returns to the softkey display screen one level higher.	
1-2-3	Sets the ports of the analyzer connected to ports a, b, and c in Figure 7-6 to test ports 1, 2, and 3, respectively.	:CALC{1-16}:FSIM:EMB:TOP:B:PORT 1,2,3
1-2-4*2	Sets the ports of the analyzer connected to ports a, b, and c in Figure 7-6 to test ports 1, 2, and 4, respectively.	:CALC{1-16}:FSIM:EMB:TOP:B:PORT 1,2,4
1-3-2	Sets the ports of the analyzer connected to ports a, b, and c in Figure 7-6 to test ports 1, 3, and 2, respectively.	:CALC{1-16}:FSIM:EMB:TOP:B:PORT 1,3,2
1-3-4*2	Sets the ports of the analyzer connected to ports a, b, and c in Figure 7-6 to test ports 1, 3, and 4, respectively.	:CALC{1-16}:FSIM:EMB:TOP:B:PORT 1,3,4
1-4-2*2	Sets the ports of the analyzer connected to ports a, b, and c in Figure 7-6 to test ports 1, 4, and 2, respectively.	:CALC{1-16}:FSIM:EMB:TOP:B:PORT 1,4,2
1-4-3*2	Sets the ports of the analyzer connected to ports a, b, and c in Figure 7-6 to test ports 1, 4, and 3, respectively.	:CALC{1-16}:FSIM:EMB:TOP:B:PORT 1,4,3
2-1-3	Sets the ports of the analyzer connected to ports a, b, and c in Figure 7-6 to test ports 2, 1, and 3, respectively.	:CALC{1-16}:FSIM:EMB:TOP:B:PORT 2,1,3
2-1-4*2	Sets the ports of the analyzer connected to ports a, b, and c in Figure 7-6 to test ports 2, 1, and 4, respectively.	:CALC{1-16}:FSIM:EMB:TOP:B:PORT 2,1,4
2-3-1	Sets the ports of the analyzer connected to ports a, b, and c in Figure 7-6 to test ports 2, 3, and 1, respectively.	:CALC{1-16}:FSIM:EMB:TOP:B:PORT 2,3,1
2-3-4*2	Sets the ports of the analyzer connected to ports a, b, and c in Figure 7-6 to test ports 2, 3, and 4, respectively.	:CALC{1-16}:FSIM:EMB:TOP:B:PORT 2,3,4
2-4-1*2	Sets the ports of the analyzer connected to ports a, b, and c in Figure 7-6 to test ports 2, 4, and 1, respectively.	:CALC{1-16}:FSIM:EMB:TOP:B:PORT 2,4,1
2-4-3*2	Sets the ports of the analyzer connected to ports a, b, and c in Figure 7-6 to test ports 2, 4, and 3, respectively.	:CALC{1-16}:FSIM:EMB:TOP:B:PORT 2,4,3
3-1-2	Sets the ports of the analyzer connected to ports a, b, and c in Figure 7-6 to test ports 3, 1, and 2, respectively.	:CALC{1-16}:FSIM:EMB:TOP:B:PORT 3,1,2
3-1-4*2	Sets the ports of the analyzer connected to ports a, b, and c in Figure 7-6 to test ports 3, 1, and 4, respectively.	:CALC{1-16}:FSIM:EMB:TOP:B:PORT 3,1,4
3-2-1	Sets the ports of the analyzer connected to ports a, b, and c in Figure 7-6 to test ports 3, 2, and 1, respectively.	:CALC{1-16}:FSIM:EMB:TOP:B:PORT 3,2,1

Softkey Functions Analysis Menu

Key Operation	Function	SCPI Command
Analysis	(Continued)	
Fixture Simulator		
De-Embedding S4P		
Topology		
Ports		
3-2-4* ²	Sets the ports of the analyzer connected to ports a, b, and c in Figure 7-6 to test ports 3, 2, and 4, respectively.	:CALC{1-16}:FSIM:EMB:TOP:B:PORT 3,2,4
3-4-1* ²	Sets the ports of the analyzer connected to ports a, b, and c in Figure 7-6 to test ports 3, 4, and 1, respectively.	:CALC{1-16}:FSIM:EMB:TOP:B:PORT 3,4,1
3-4-2* ²	Sets the ports of the analyzer connected to ports a, b, and c in Figure 7-6 to test ports 3, 4, and 2, respectively.	:CALC{1-16}:FSIM:EMB:TOP:B:PORT 3,4,2
4-1-2* ²	Sets the ports of the analyzer connected to ports a, b, and c in Figure 7-6 to test ports 4, 1, and 2, respectively.	:CALC{1-16}:FSIM:EMB:TOP:B:PORT 4,1,2
4-1-3* ²	Sets the ports of the analyzer connected to ports a, b, and c in Figure 7-6 to test ports 4, 1, and 3, respectively.	:CALC{1-16}:FSIM:EMB:TOP:B:PORT 4,1,3
4-2-1* ²	Sets the ports of the analyzer connected to ports a, b, and c in Figure 7-6 to test ports 4, 2, and 1, respectively.	:CALC{1-16}:FSIM:EMB:TOP:B:PORT 4,2,1
4-2-3* ²	Sets the ports of the analyzer connected to ports a, b, and c in Figure 7-6 to test ports 4, 2, and 3, respectively.	:CALC{1-16}:FSIM:EMB:TOP:B:PORT 4,2,3
4-3-1* ²	Sets the ports of the analyzer connected to ports a, b, and c in Figure 7-6 to test ports 4, 3, and 1, respectively.	:CALC{1-16}:FSIM:EMB:TOP:B:PORT 4,3,1
4-3-2* ²	Sets the ports of the analyzer connected to ports a, b, and c in Figure 7-6 to test ports 4, 3, and 2, respectively.	:CALC{1-16}:FSIM:EMB:TOP:B:PORT 4,3,2
Cancel	Returns to the softkey display screen one level higher.	
Ports* ²	Displays the softkey to select a port of the analyzer (test port) that you want to connect to the DUT. (When you select A on the Select Topology menu.)	
1-2-3-4	Sets the ports of the analyzer connected to ports a, b, c and d in Figure 7-6 to test ports 1, 2, 3, and 4, respectively.	:CALC{1-16}:FSIM:EMB:TOP:C:PORT 1,2,3,4
1-2-4-3	Sets the ports of the analyzer connected to ports a, b, c and d in Figure 7-6 to test ports 1, 2, 4, and 3, respectively.	:CALC{1-16}:FSIM:EMB:TOP:C:PORT 1,2,4,3
1-3-2-4	Sets the ports of the analyzer connected to ports a, b, c and d in Figure 7-6 to test ports 1, 3, 2, and 4, respectively.	:CALC{1-16}:FSIM:EMB:TOP:C:PORT 1,3,2,4
1-3-4-2	Sets the ports of the analyzer connected to ports a, b, c and d in Figure 7-6 to test ports 1, 3, 4, and 2, respectively.	:CALC{1-16}:FSIM:EMB:TOP:C:PORT 1,3,4,2
1-4-2-3	Sets the ports of the analyzer connected to ports a, b, c and d in Figure 7-6 to test ports 1, 4, 2, and 3, respectively.	:CALC{1-16}:FSIM:EMB:TOP:C:PORT 1,4,2,3
1-4-3-2	Sets the ports of the analyzer connected to ports a, b, c and d in Figure 7-6 to test ports 1, 4, 3, and 2, respectively.	:CALC{1-16}:FSIM:EMB:TOP:C:PORT 1,4,3,2
2-1-3-4	Sets the ports of the analyzer connected to ports a, b, c and d in Figure 7-6 to test ports 2, 1, 3, and 4, respectively.	:CALC{1-16}:FSIM:EMB:TOP:C:PORT 2,1,3,4
2-1-4-3	Sets the ports of the analyzer connected to ports a, b, c and d in Figure 7-6 to test ports 2, 1, 4, and 3, respectively.	:CALC{1-16}:FSIM:EMB:TOP:C:PORT 2,1,4,3
2-3-1-4	Sets the ports of the analyzer connected to ports a, b, c and d in Figure 7-6 to test ports 2, 3, 1, and 4, respectively.	:CALC{1-16}:FSIM:EMB:TOP:C:PORT 2,3,1,4
2-3-4-1	Sets the ports of the analyzer connected to ports a, b, c and d in Figure 7-6 to test ports 2, 3, 4, and 1, respectively.	:CALC{1-16}:FSIM:EMB:TOP:C:PORT 2,3,4,1
2-4-1-3	Sets the ports of the analyzer connected to ports a, b, c and d in Figure 7-6 to test ports 2, 4, 1, and 3, respectively.	:CALC{1-16}:FSIM:EMB:TOP:C:PORT 2,4,1,3
2-4-3-1	Sets the ports of the analyzer connected to ports a, b, c and d in Figure 7-6 to test ports 2, 4, 3, and 1, respectively.	:CALC{1-16}:FSIM:EMB:TOP:C:PORT 2,4,3,1

Key Operation	Function	SCPI Command
Analysis	(Continued)	
Fixture Simulator		
De-Embedding S4P		
Topology		
Ports*2		
3-1-2-4	Sets the ports of the analyzer connected to ports a, b, c and d in Figure 7-6 to test ports 3, 1, 2, and 4, respectively.	:CALC{1-16}:FSIM:EMB:TOP:C:PORT 3,1,2,4
3-1-4-2	Sets the ports of the analyzer connected to ports a, b, c and d in Figure 7-6 to test ports 3, 1, 4, and 2, respectively.	:CALC{1-16}:FSIM:EMB:TOP:C:PORT 3,1,4,2
3-2-1-4	Sets the ports of the analyzer connected to ports a, b, c and d in Figure 7-6 to test ports 3, 2, 1, and 4, respectively.	:CALC{1-16}:FSIM:EMB:TOP:C:PORT 3,2,1,4
3-2-4-1	Sets the ports of the analyzer connected to ports a, b, c and d in Figure 7-6 to test ports 3, 2, 4, and 1, respectively.	:CALC{1-16}:FSIM:EMB:TOP:C:PORT 3,2,4,1
3-4-1-2	Sets the ports of the analyzer connected to ports a, b, c and d in Figure 7-6 to test ports 3, 4, 1, and 2, respectively.	:CALC{1-16}:FSIM:EMB:TOP:C:PORT 3,4,1,2
3-4-2-1	Sets the ports of the analyzer connected to ports a, b, c and d in Figure 7-6 to test ports 3, 4, 2, and 1, respectively.	:CALC{1-16}:FSIM:EMB:TOP:C:PORT 3,4,2,1
4-1-2-3	Sets the ports of the analyzer connected to ports a, b, c and d in Figure 7-6 to test ports 4, 1, 2, and 3, respectively.	:CALC{1-16}:FSIM:EMB:TOP:C:PORT 4,1,2,3
4-1-3-2	Sets the ports of the analyzer connected to ports a, b, c and d in Figure 7-6 to test ports 4, 1, 3, and 2, respectively.	:CALC{1-16}:FSIM:EMB:TOP:C:PORT 4,1,3,2
4-2-1-3	Sets the ports of the analyzer connected to ports a, b, c and d in Figure 7-6 to test ports 4, 2, 1, and 3, respectively.	:CALC{1-16}:FSIM:EMB:TOP:C:PORT 4,2,1,3
4-2-3-1	Sets the ports of the analyzer connected to ports a, b, c and d in Figure 7-6 to test ports 4, 2, 3, and 1, respectively.	:CALC{1-16}:FSIM:EMB:TOP:C:PORT 4,2,3,1
4-3-1-2	Sets the ports of the analyzer connected to ports a, b, c and d in Figure 7-6 to test ports 4, 3, 1, and 2, respectively.	:CALC{1-16}:FSIM:EMB:TOP:C:PORT 4,3,1,2
4-3-2-1	Sets the ports of the analyzer connected to ports a, b, c and d in Figure 7-6 to test ports 4, 3, 2, and 1, respectively.	:CALC{1-16}:FSIM:EMB:TOP:C:PORT 4,3,2,1
Cancel	Returns to the softkey display screen one level higher.	
Type (nwk1)	Displays the softkey to select the processing (embedding/de-embedding) of the network 1 (nwk1).	
None	Select disabled (not embedded nor de-embedded).	:CALC{1-16}:FSIM:EMB:NETW1:TYPE NONE
Embed	Select embedding.	:CALC{1-16}:FSIM:EMB:NETW1:TYPE EMB
De-Embed	Select de-embedding.	:CALC{1-16}:FSIM:EMB:NETW1:TYPE DEEM
Cancel	Returns to the softkey display screen one level higher.	
User File (nwk1)	Opens the dialog box to read in a 4 port touchstone data file that the user prepared for the network 1. You can embed/de-embed the network read in here.	:CALC{1-16}:FSIM:EMB:NETW1:FILE
Type (nwk2)	Displays the softkey to select the processing (embedding/de-embedding) of the network 2 (nwk2).	
None	Select disabled (not embedded nor de-embedded).	:CALC{1-16}:FSIM:EMB:NETW2:TYPE NONE
Embed	Select embedding.	:CALC{1-16}:FSIM:EMB:NETW2:TYPE EMB

Softkey Functions Analysis Menu

Key Operation	Function	SCPI Command
Analysis	(Continued)	
Fixture Simulator		
De-Embedding S4P		
Topology		
Type (nwk2)		
De-Embed	Select de-embedding.	:CALC{1-16}:FSIM:EMB:NETW2:TYPE DEEM
Cancel	Returns to the softkey display screen in one level higher.	
User File (nwk2)	Opens the dialog box to read in a 4 port touchstone data file that the user prepared for the network 2. You can embed/de-embed the network read in here.	:CALC{1-16}:FSIM:EMB:NETW2:FILE
Return	Returns to the softkey display screen one level higher.	
Return	Returns to the softkey display screen one level higher.	
Return	Returns to the softkey display screen one level higher.	
Gating	Displays softkeys for setting up the gating function of the time domain function.	
Gating	Enables or disables the gating function.	:CALC{1-16}:FILT:TIME:STAT
Start	Sets the start value of the gate.	:CALC{1-16}:FILT:TIME:STAR
Stop	Sets the stop value of the gate.	:CALC{1-16}:FILT:TIME:STOP
Center	Sets the center value of the gate.	:CALC{1-16}:FILT:TIME:CENT
Span	Sets the span value of the gate.	:CALC{1-16}:FILT:TIME:SPAN
Type	Sets a type of the gate (bandpass/notch).	:CALC{1-16}:FILT:TIME:SPAN
Shape	Displays softkeys for selecting a shape of the gate.	
Maximum	Selects the maximum shape.	:CALC{1-16}:FILT:TIME:SHAP MAX
Wide	Selects the wide shape.	:CALC{1-16}:FILT:TIME:SHAP WIDE
Normal	Selects the normal shape.	:CALC{1-16}:FILT:TIME:SHAP NORM
Minimum	Selects the minimum shape.	:CALC{1-16}:FILT:TIME:SHAP MIN
Cancel	Returns to the softkey display screen one level higher.	
Return	Returns to the softkey display screen one level higher.	
Transform	Displays softkeys for setting up the transform function of the time domain function.	
Transform	Enables or disables the transform function.	:CALC{1-16}:TRAN:TIME:STAT
Start	Sets the start value.	:CALC{1-16}:TRAN:TIME:STAR
Stop	Sets the stop value.	:CALC{1-16}:TRAN:TIME:STOP
Center	Sets the center value.	:CALC{1-16}:TRAN:TIME:CENT
Span	Sets the span value.	:CALC{1-16}:TRAN:TIME:SPAN
Set Freq Low Pass	Changes the frequency range to match with the low-pass type transformation.	:CALC{1-16}:TRAN:TIME:LPPFR
Type	Displays softkeys for selecting a type of the transform.	
Bandpass	Selects the bandpass mode.	:CALC{1-16}:TRAN:TIME BPAS
Lowpass Step	Selects the lowpass step mode.	:CALC{1-16}:TRAN:TIME LPAS :CALC{1-16}:TRAN:TIME:STIM STEP
Lowpass Imp	Selects the lowpass impulse mode.	:CALC{1-16}:TRAN:TIME LPAS :CALC{1-16}:TRAN:TIME:STIM STEP
Cancel	Returns to the softkey display screen one level higher.	

Key Operation	Function	SCPI Command
Analysis	(Continued)	
Transform		
Window	Displays softkeys for selecting a type of the window.	
Maximum	Selects the maximum type.	:CALC{1-16}:TRAN:TIME KBES 13
Normal	Selects the normal type.	:CALC{1-16}:TRAN:TIME KBES 6
Minimum	Selects the minimum type.	:CALC{1-16}:TRAN:TIME KBES 0
User	Displays softkeys for setting up the user window shape.	
Impulse Width	Sets the impulse width value.	:CALC{1-16}:TRAN:TIME IMP:WIDT
Rise Time	Sets the rise time of the step signal.	:CALC{1-16}:TRAN:TIME STEP:RTIM
Kaiser Beta	Sets the b value of Kaiser Bessel window.	:CALC{1-16}:TRAN:TIME KBES
Return	Returns to the softkey display screen one level higher.	
Return	Returns to the softkey display screen one level higher.	
Conversion	Displays softkeys for setting up the conversion function.	
Conversion	Enables or disables the conversion function.	:CALC{1-16}:CONV
Function	Displays softkeys for selecting a converted parameter.	
Z:Reflection	Selects the equivalent impedance in reflection measurement.	:CALC{1-16}:CONV:FUNC ZREF
Z:Transmission	Selects the equivalent impedance in transmission measurement.	:CALC{1-16}:CONV:FUNC ZTR
Z:Trans-Shunt	Selects the equivalent impedance in transmission-shunt measurement.	:CALC{1-16}:CONV:FUNC ZTSH
Y:Reflection	Selects the equivalent admittance in reflection measurement.	:CALC{1-16}:CONV:FUNC YREF
Y:Transmission	Selects the equivalent admittance in transmission measurement.	:CALC{1-16}:CONV:FUNC YTR
Y:Trans-Shunt	Selects the equivalent admittance in transmission-shunt measurement.	:CALC{1-16}:CONV:FUNC YTSH
1/S	Selects the inverse S-parameter.	:CALC{1-16}:CONV:FUNC INV
Conjugation	Selects the conjugation.	:CALC{1-16}:CONV:FUNC CONJ
Cancel	Returns to the softkey display screen one level higher.	
Return	Returns to the softkey display screen one level higher.	
Limit Test	Displays softkeys for setting up the limit test function.	
Limit Test	Enables or disables the limit test function.	:CALC{1-16}:LIM
Limit Line	Enables or disables the limit line display.	:CALC{1-16}:LIM:DISP
Edit Limit Line	Displays softkeys for editing the limit line.	
Delete	Deletes the line at the cursor from the limit table.	:CALC{1-16}:LIM:DATA
Add	Adds a new segment to the limit table under the line on which the cursor is located.	:CALC{1-16}:LIM:DATA
Clear Limit Table	Displays softkeys for clearing the contents of the limit table.	:CALC{1-16}:LIM:DATA
OK	Deletes all segments in the limit table.	:CALC{1-16}:LIM:DATA
Cancel	Returns to the softkey display screen one level higher.	
Export to CSV File	Exports (saves the data in formats used by other software) the limit table to a CSV (comma-separated value) file.	:MMEM:STOR:LIM
Import from CSV File	Imports (loads the data from files in different formats) a CSV (comma-separated value) file to the limit table.	:MMEM:LOAD:LIM
Return	Returns to the softkey display screen one level higher.	
Limit Line Offset	Displays softkeys for setting up the limit line offset function.	
Stimulus Offset	Sets the stimulus offsets.	:CALC{1-16}:LIM:OFFS:STIM
Amplitude Offset	Sets the amplitude offsets.	:CALC{1-16}:LIM:OFFS:AMPL

Softkey Functions Analysis Menu

Key Operation	Function	SCPI Command
Analysis	(Continued)	
Limit Test		
Limit Line Offset		
Marker -> Amplitude Offset	Marker to limit offset. Centers the limit lines around the current marker position by using the limit amplitude offset function.	:CALC{1-16}:LIM:OFFS:MARK
Return	Returns to the softkey display screen one level higher.	
Fail Sign	Turns on/off the display of the limit test fail sign.	:DISP:FSIG
Return	Returns to the softkey display screen one level higher.	
Ripple Limit	Displays softkeys for setting up the ripple limit	
Ripple Limit Test	Enables or disables the ripple limit test function.	:CALC{1-16}:RLIM
Ripple Limit	Enables or disables the ripple limit line display.	:CALC{1-16}:RLIM:DISP:LINE
Ripple Value	Displays softkeys for setting up the ripple value function.	
OFF	Disables the display of ripple value.	:CALC{1-16}:RLIM:DISP:VAL OFF
ABS	Sets the absolute value as the display type of the ripple value.	:CALC{1-16}:RLIM:DISP:VAL ABS
MAR	Sets the margin as the display type of the ripple value.	:CALC{1-16}:RLIM:DISP:VAL MAR
Ripple Band	Displays softkeys for setting up the ripple value function.	
1	Sets the value of ripple band to 1.	:CALC{1-16}:RLIM:DISP:SEL
:	:	:
12	Sets the value of ripple band to 12.	:CALC{1-16}:RLIM:DISP:SEL
Cancel	Returns to the softkey display screen one level higher.	
Edit Ripple Limit	Displays softkeys for editing the ripple limit line.	
Delete	Deletes the line at the cursor from the limit table.	:CALC{1-16}:RLIM:DATA
Add	Adds a new segment to the limit table under the line on which the cursor is located.	:CALC{1-16}:RLIM:DATA
Clear Limit Table	Displays softkeys for clearing the contents of the limit table.	:CALC{1-16}:RLIM:DATA
OK	Deletes all segments in the limit table.	:CALC{1-16}:RLIM:DATA
Cancel	Returns to the softkey display screen one level higher.	
Export to CSV File	Exports (saves the data in formats used by other software) the limit table to a CSV (comma-separated value) file.	:MMEM:STOR:RLIM
Import from CSV File	Imports (loads the data from files in different formats) a CSV (comma-separated value) file to the limit table.	:MMEM:LOAD:RLIM
Return	Returns to the softkey display screen one level higher.	
Fail Sign	Turns on/off the display of the ripple limit test fail sign.	:DISP:FSIG
Return	Returns to the softkey display screen one level higher.	
Bandwidth Limit	Displays softkeys for setting up the bandwidth limit test function.	
BW Test	Enables or disables the bandwidth test function.	:CALC{1-16}:BLIM
BW Display	Enables or disables the bandwidth display.	:CALC{1-16}:BLIM:DISP:VAL
BW Marker	Enables or disables the bandwidth marker display.	:CALC{1-16}:BLIM:DISP:MARK
N dB Points	Sets the threshold of bandwidth test.	:CALC{1-16}:BLIM:DB
Min Bandwidth	Sets the lower limit value.	:CALC{1-16}:BLIM:MIN
Max Bandwidth	Sets the upper limit value.	:CALC{1-16}:BLIM:MAX
Fail Sign	Turns on/off the display of the bandwidth limit test fail sign.	:DISP:FSIG
Return	Returns to the softkey display screen one level higher.	
Return	Returns to the "E5070B/E5071B Menu (Top Menu)" on page 646.	

- *1. Only with Options 313, 314, 413, and 414.
- *2. Only with Options 413 and 414.

Average Menu

Key Operation	Function	SCPI Command
Avg	Displays softkeys for setting averaging options.	
Averaging Restart	Resets the counter and restarts from “1”.	:SENS{1-16}:AVER:CLE
Avg Factor	Sets the averaging factor. The averaging factor must be defined as an integer from 1 to 999.	:SENS{1-16}:AVER:COUN
Averaging	Enables or disables averaging execution.	:SENS{1-16}:AVER
Ave Trigger	Enables or disables averaging trigger.	:TRIG:AVER
Smo Aperture	Sets the smoothing aperture using a percentage against the sweep span	:CALC{1-16}:SMO:APER
Smoothing	Enables or disables the smoothing function. When enabled, the letters “Smo” will appear in the trace status area.	:CALC{1-16}:SMO:STAT
IF Bandwidth	Sets the IF bandwidth. For more about the effective range of the IF bandwidth, refer to “Specifications and Reference Data”. If an input value is out of the range, it will automatically be modified to the closest value in the effective range. A narrow IF bandwidth slows down the sweep speed, but improves the S/N ratio.	:SENS{1-16}:BAND or :SENS{1-16}:BWID
Return	Returns to the “E5070B/E5071B Menu (Top Menu)” on page 646.	

Calibration Menu

Key Operation	Function	SCPI Command
Cal	Displays softkeys for setting and executing calibrations.	
Correction	Enables or disables error correction.	:SENS{1-16}:CORR:STAT
Calibrate	Displays softkeys for selecting calibration options.	
Response (Open)	Displays softkeys for selecting options for response calibration using the OPEN standard.	
Select Port	Displays softkeys for selecting a test port.	
1	Selects test port 1.	:SENS{1-16}:CORR:COLL:METH:OPEN 1
2	Selects test port 2.	:SENS{1-16}:CORR:COLL:METH:OPEN 2
3*1	Selects test port 3.	:SENS{1-16}:CORR:COLL:METH:OPEN 3
4*2	Selects test port 4.	:SENS{1-16}:CORR:COLL:METH:OPEN 4
Cancel	Returns to the softkey display screen one level higher.	
Open	Executes a response calibration using the OPEN standard on the test port selected in the Select Port menu. This calibration is effective for eliminating response tracking errors.	:SENS{1-16}:CORR:COLL:OPEN
Load (Optional)	Executes an isolation calibration using the LOAD standard on the test port selected in the Select Port menu. This calibration is effective for eliminating directivity errors.	:SENS{1-16}:CORR:COLL:LOAD
Done	Terminates a calibration process and calculates the calibration coefficients.	:SENS{1-16}:CORR:COLL:SAVE
Cancel	Displays softkeys for canceling a calibration.	
OK	Cancel a calibration process and clears the measurement data of standard.	:SENS{1-16}:CORR:COLL:CLE
Cancel	Returns to the softkey display screen one level higher.	
Return	Returns to the softkey display screen one level higher.	
Response (Short)	Displays softkeys for selecting options for a response calibration using the SHORT standard.	
Select Port	Displays softkeys for selecting a test port.	
1	Selects test port 1.	:SENS{1-16}:CORR:COLL:METH:SHOR 1
2	Selects test port 2.	:SENS{1-16}:CORR:COLL:METH:SHOR 2
3*1	Selects test port 3.	:SENS{1-16}:CORR:COLL:METH:SHOR 3
4*2	Selects test port 4.	:SENS{1-16}:CORR:COLL:METH:SHOR 4
Cancel	Returns to the softkey display screen one level higher.	
Short	Executes a SHORT calibration on the test port selected in the Select Port menu. This calibration is effective for eliminating reflection tracking errors.	:SENS{1-16}:CORR:COLL:SHOR
Load (Optional)	Executes an isolation calibration using the LOAD standard on the test port selected in the Select Port menu. This calibration is effective for eliminating directivity errors.	:SENS{1-16}:CORR:COLL:LOAD
Done	Terminates a calibration process and calculates the calibration coefficients.	:SENS{1-16}:CORR:COLL:SAVE
Cancel	Displays softkeys for canceling a calibration.	
OK	Cancel a calibration process and clears the measurement data of standard.	:SENS{1-16}:CORR:COLL:CLE
Cancel	Returns to the softkey display screen one level higher.	
Return	Returns to the softkey display screen one level higher.	

Softkey Functions Calibration Menu

Key Operation	Function	SCPI Command
Cal	(Continued)	
Calibrate		
Response (Thru)	Displays softkeys for selecting options for response calibrations using the THRU standard.	
Select Ports	Displays softkeys for selecting test ports.	
2-1 (S21)	Selects the transmission test (measurement of S_{21}) for test port 1→2.	:SENS{1-16}:CORR:COLL:METH:THRU 2,1
3-1 (S31) ^{*1}	Selects the transmission test (measurement of S_{31}) for test port 1→3.	:SENS{1-16}:CORR:COLL:METH:THRU 3,1
4-1 (S41) ^{*2}	Selects the transmission test (measurement of S_{41}) for test port 1→4.	:SENS{1-16}:CORR:COLL:METH:THRU 4,1
1-2 (S12)	Selects the transmission test (measurement of S_{12}) for test port 2→1.	:SENS{1-16}:CORR:COLL:METH:THRU 1,2
3-2 (S32) ^{*1}	Selects the transmission test (measurement of S_{32}) for test port 2→3.	:SENS{1-16}:CORR:COLL:METH:THRU 3,2
4-2 (S42) ^{*2}	Selects the transmission test (measurement of S_{42}) for test port 2→4.	:SENS{1-16}:CORR:COLL:METH:THRU 4,2
1-3 (S13) ^{*1}	Selects the transmission test (measurement of S_{13}) for test port 3→1.	:SENS{1-16}:CORR:COLL:METH:THRU 1,3
2-3 (S23) ^{*1}	Selects the transmission test (measurement of S_{23}) for test port 3→2.	:SENS{1-16}:CORR:COLL:METH:THRU 2,3
4-3 (S43) ^{*2}	Selects the transmission test (measurement of S_{43}) for test port 3→4.	:SENS{1-16}:CORR:COLL:METH:THRU 4,3
1-4 (S14) ^{*2}	Selects the transmission test (measurement of S_{14}) for test port 4→1.	:SENS{1-16}:CORR:COLL:METH:THRU 1,4
2-4 (S24) ^{*2}	Selects the transmission test (measurement of S_{24}) for test port 4→2.	:SENS{1-16}:CORR:COLL:METH:THRU 2,4
3-4 (S34) ^{*2}	Selects the transmission test (measurement of S_{34}) for test port 4→3.	:SENS{1-16}:CORR:COLL:METH:THRU 3,4
Cancel	Returns to the softkey display screen one level higher.	
Thru	Executes a THRU response calibration on the test ports selected in the Select Ports menu. This calibration is effective for eliminating transmission tracking errors.	:SENS{1-16}:CORR:COLL:THRU
Isolation (Optional)	Executes an isolation calibration on the test ports selected in the Select Ports menu. This calibration is effective for eliminating isolation errors.	:SENS{1-16}:CORR:COLL:ISOL
Done	Terminates a calibration process and calculates the calibration coefficients.	:SENS{1-16}:CORR:COLL:SAVE
Cancel	Displays softkeys for canceling a calibration.	
OK	Cancels a calibration process and clears the measurement data of standard.	:SENS{1-16}:CORR:COLL:CLE
Cancel	Returns to the softkey display screen one level higher.	
Return	Returns to the softkey display screen one level higher.	
Enhanced Response	Displays softkeys for executing enhanced response calibrations.	
Select Port	Displays softkeys for selecting a test port.	
2-1 (S21 S11)	Selects the transmission test (measurement of S_{21}) for test port 1→2.	:SENS{1-16}:CORR:COLL:METH:ERES 2,1

Key Operation	Function	SCPI Command
Cal	(Continued)	
Calibrate		
Enhanced Response		
Select Port		
3-1 (S31 S11)* ¹	Selects the transmission test (measurement of S_{31}) for test port 1→3.	:SENS{1-16}:CORR:COLL:METH:ERES 3,1
4-1 (S41 S11)* ²	Selects the transmission test (measurement of S_{41}) for test port 1→4.	:SENS{1-16}:CORR:COLL:METH:ERES 4,1
1-2 (S12 S22)	Selects the transmission test (measurement of S_{12}) for test port 2→1.	:SENS{1-16}:CORR:COLL:METH:ERES 1,2
3-2 (S32 S22)* ¹	Selects the transmission test (measurement of S_{32}) for test port 2→3.	:SENS{1-16}:CORR:COLL:METH:ERES 3,2
4-2 (S42 S22)* ²	Selects the transmission test (measurement of S_{42}) for test port 2→4.	:SENS{1-16}:CORR:COLL:METH:ERES 4,2
1-3 (S13 S33)* ¹	Selects the transmission test (measurement of S_{13}) for test port 3→1.	:SENS{1-16}:CORR:COLL:METH:ERES 1,3
2-3 (S23 S33)* ¹	Selects the transmission test (measurement of S_{23}) for test port 3→2.	:SENS{1-16}:CORR:COLL:METH:ERES 2,3
4-3 (S43 S33)* ²	Selects the transmission test (measurement of S_{43}) for test port 3→4.	:SENS{1-16}:CORR:COLL:METH:ERES 4,3
1-4 (S14 S44)* ²	Selects the transmission test (measurement of S_{14}) for test port 4→1.	:SENS{1-16}:CORR:COLL:METH:ERES 1,4
2-4 (S24 S44)* ²	Selects the transmission test (measurement of S_{24}) for test port 4→2.	:SENS{1-16}:CORR:COLL:METH:ERES 2,4
3-4 (S34 S44)* ²	Selects the transmission test (measurement of S_{34}) for test port 4→3.	:SENS{1-16}:CORR:COLL:METH:ERES 3,4
Cancel	Returns to the softkey display screen one level higher.	
Open	Executes an OPEN calibration on the test port selected in the Select Port menu.	:SENS{1-16}:CORR:COLL:OPEN
Short	Executes a SHORT calibration on the test port selected in the Select Port menu.	:SENS{1-16}:CORR:COLL:SHOR
Load	Executes a LOAD calibration on the test port selected in the Select Port menu.	:SENS{1-16}:CORR:COLL:LOAD
Thru	Executes a THRU response calibration on the test ports selected in the Select Ports menu.	:SENS{1-16}:CORR:COLL:THRU
Isolation (Optional)	Executes an isolation calibration on the test ports selected in the Select Ports menu.	:SENS{1-16}:CORR:COLL:ISOL
Done	Terminates a calibration process and calculates the calibration coefficients.	:SENS{1-16}:CORR:COLL:SAVE
Cancel	Displays softkeys for canceling a calibration.	
OK	Cancel a calibration process and clears the measurement data of standard.	:SENS{1-16}:CORR:COLL:CLE
Cancel	Returns to the softkey display screen one level higher.	
Return	Returns to the softkey display screen one level higher.	

Softkey Functions Calibration Menu

Key Operation	Function	SCPI Command
Cal	(Continued)	
Calibrate		
1-Port Cal	Displays softkeys for executing 1-port calibrations.	
Select Port	Displays softkeys for selecting a test port.	
1	Selects test port 1.	:SENS{1-16}:CORR:COLL:METH:SOLT1 1
2	Selects test port 2.	:SENS{1-16}:CORR:COLL:METH:SOLT1 2
3 ^{*1}	Selects test port 3.	:SENS{1-16}:CORR:COLL:METH:SOLT1 3
4 ^{*2}	Selects test port 4.	:SENS{1-16}:CORR:COLL:METH:SOLT1 4
Select Port		
Cancel	Returns to the softkey display screen one level higher.	
Open	Executes an OPEN calibration on the test port selected in the Select Port menu.	:SENS{1-16}:CORR:COLL:OPEN
Short	Executes a SHORT calibration on the test port selected in the Select Port menu.	:SENS{1-16}:CORR:COLL:SHOR
Load	Executes a LOAD calibration on the test port selected in the Select Port menu.	:SENS{1-16}:CORR:COLL:LOAD
Done	Terminates a calibration process and calculates the calibration coefficients.	:SENS{1-16}:CORR:COLL:SAVE
Cancel	Displays softkeys for canceling a calibration.	
OK	Cancels a calibration process and clear the measurement data of standard.	:SENS{1-16}:CORR:COLL:CLE
Cancel	Returns to the softkey display screen one level higher.	
Return	Returns to the softkey display screen one level higher.	
2-Port Cal	Displays softkeys for executing a full 2-port calibration.	
Select Ports^{*1}	Displays softkeys for selecting test ports.	
1-2	Selects test ports 1 and 2.	:SENS{1-16}:CORR:COLL:METH:SOLT2 1,2
1-3	Selects test ports 1 and 3.	:SENS{1-16}:CORR:COLL:METH:SOLT2 1,3
1-4 ^{*2}	Selects test ports 1 and 4.	:SENS{1-16}:CORR:COLL:METH:SOLT2 1,4
2-3	Selects test ports 2 and 3.	:SENS{1-16}:CORR:COLL:METH:SOLT2 2,3
2-4 ^{*2}	Selects test ports 2 and 4.	:SENS{1-16}:CORR:COLL:METH:SOLT2 2,4
3-4 ^{*2}	Selects test ports 3 and 4.	:SENS{1-16}:CORR:COLL:METH:SOLT2 3,4
Cancel	Returns to the softkey display screen one level higher.	
Reflection	Displays softkeys for executing reflection calibrations. Symbols x and y refer to the two test ports selected in the Select Ports menu (x and y are always 1 and 2, respectively, for models with Option 213 or 214).	
Port x Open	Executes an OPEN reflection calibration on test port x.	:SENS{1-16}:CORR:COLL:OPEN x
Port x Short	Executes a SHORT reflection calibration on test port x.	:SENS{1-16}:CORR:COLL:SHOR x
Port x Load	Executes a LOAD reflection calibration on test port x.	:SENS{1-16}:CORR:COLL:LOAD x
Port y Open	Executes an OPEN reflection calibration on test port y.	:SENS{1-16}:CORR:COLL:OPEN y
Port y Short	Executes a SHORT reflection calibration on test port y.	:SENS{1-16}:CORR:COLL:SHOR y
Port y Load	Executes a LOAD reflection calibration on test port y.	:SENS{1-16}:CORR:COLL:LOAD y
Return	Returns to the softkey display screen one level higher.	

Key Operation	Function	SCPI Command
Cal	(Continued)	
Calibrate		
2-Port Cal		
Transmission	Displays softkeys for executing transmission calibrations. Symbols x and y refer to the two test ports selected in the Select Ports menu (x and y are always 1 and 2, respectively, for models with Option 213 or 214).	
Port x-y Thru	Executes a THRU calibration on test ports x and y.	:SENS{1-16}:CORR:COLL:THRU x,y :SENS{1-16}:CORR:COLL:THRU y,x
Return	Returns to the softkey display screen one level higher.	
Isolation (Optional)	Displays softkeys for executing isolation calibrations. Symbols x and y refer to the two test ports selected in the Select Ports menu (x and y are always 1 and 2, respectively, for models with Option 213 or 214).	
Port x-y Isol	Executes an isolation calibration on test ports x and y.	:SENS{1-16}:CORR:COLL:ISOL x,y :SENS{1-16}:CORR:COLL:ISOL y,x
Return	Returns to the softkey display screen one level higher.	
Done	Terminates a calibration process and calculates the calibration coefficients.	:SENS{1-16}:CORR:COLL:SAVE
Overwrite	Terminates partial overwrite and recalculates the calibration coefficients.	:SENS{1-16}:CORR:COLL:PART:SAVE
Cancel	Displays softkeys for canceling a calibration.	
OK	Cancels a calibration process and clears the measurement data of standard.	:SENS{1-16}:CORR:COLL:CLE
Cancel	Returns to the softkey display screen one level higher.	
Return	Returns to the softkey display screen one level higher.	
3-Port Cal ^{*1}	Displays softkeys for executing full 3-port calibrations.	
Select Ports ^{*2}	Displays softkeys for selecting test ports.	
1-2-3	Selects test ports 1, 2, and 3.	:SENS{1-16}:CORR:COLL:METH:SOLT3 1,2,3
1-2-4	Selects test ports 1, 2, and 4.	:SENS{1-16}:CORR:COLL:METH:SOLT3 1,2,4
1-3-4	Selects test ports 1, 3, and 4.	:SENS{1-16}:CORR:COLL:METH:SOLT3 1,3,4
2-3-4	Selects test ports 2, 3, and 4.	:SENS{1-16}:CORR:COLL:METH:SOLT3 2,3,4
Cancel	Returns to the softkey display screen one level higher.	
Reflection	Displays softkeys for executing reflection calibrations. Symbols x, y, and z refer to the three test ports selected in the Select Ports menu (x, y, and z are always 1, 2, and 3, respectively, for models with Option 313 or 314).	
Port x Open	Executes an OPEN reflection calibration on test port x.	:SENS{1-16}:CORR:COLL:OPEN x
Port x Short	Executes a SHORT reflection calibration on test port x.	:SENS{1-16}:CORR:COLL:SHOR x
Port x Load	Executes a LOAD reflection calibration on test port x.	:SENS{1-16}:CORR:COLL:LOAD x
Port y Open	Executes an OPEN reflection calibration on test port y.	:SENS{1-16}:CORR:COLL:OPEN y
Port y Short	Executes a SHORT reflection calibration on test port y.	:SENS{1-16}:CORR:COLL:SHOR y
Port y Load	Executes a LOAD reflection calibration on test port y.	:SENS{1-16}:CORR:COLL:LOAD y
Port z Open	Executes an OPEN reflection calibration on test port z.	:SENS{1-16}:CORR:COLL:OPEN z
Port z Short	Executes a SHORT reflection calibration on test port z.	:SENS{1-16}:CORR:COLL:SHOR z
Port z Load	Executes a LOAD reflection calibration on test port z.	:SENS{1-16}:CORR:COLL:LOAD z
Return	Returns to the softkey display screen one level higher.	
Transmission	Displays softkeys for executing transmission calibrations. Symbols x, y, and z refer to the three test ports selected in the Select Ports menu (x, y, and z are always 1, 2, and 3, respectively, for models with Option 313 or 314).	
Port x-y Thru	Executes a THRU calibration on test ports x and y.	:SENS{1-16}:CORR:COLL:THRU x,y :SENS{1-16}:CORR:COLL:THRU y,x
Port x-z Thru	Executes a THRU calibration on test ports x and z.	:SENS{1-16}:CORR:COLL:THRU x,z :SENS{1-16}:CORR:COLL:THRU z,x

Softkey Functions Calibration Menu

Key Operation	Function	SCPI Command
Cal	(Continued)	
Calibrate		
3-Port Cal* ¹		
Transmission		
Port y-z Thru	Executes a THRU calibration on test ports y and z.	:SENS{1-16}:CORR:COLL:THRU y,z :SENS{1-16}:CORR:COLL:THRU z,y
Return	Returns to the softkey display screen one level higher.	
Isolation (Optional)	Displays softkeys for executing isolation calibrations. Symbols x, y, and z refer to the three test ports selected in the Select Ports menu (x, y, and z are always 1, 2, and 3, respectively, for models with Option 313 or 314).	
Port x-y Isol	Executes an isolation test on test ports x and y.	:SENS{1-16}:CORR:COLL:ISOL x,y :SENS{1-16}:CORR:COLL:ISOL y,x
Port x-z Isol	Executes an isolation test on test ports x and z.	:SENS{1-16}:CORR:COLL:ISOL x,z :SENS{1-16}:CORR:COLL:ISOL z,x
Port y-z Isol	Executes an isolation test on test ports y and z.	:SENS{1-16}:CORR:COLL:ISOL y,z :SENS{1-16}:CORR:COLL:ISOL z,y
Return	Returns to the softkey display screen one level higher.	
Done	Terminates a calibration process and calculates the calibration coefficients.	:SENS{1-16}:CORR:COLL:SAVE
Overwrite	Terminates partial overwrite and recalculates the calibration coefficients.	:SENS{1-16}:CORR:COLL:PART:SAVE
Cancel	Displays softkeys for canceling a calibration.	
OK	Cancels a calibration process and clears the measurement data of standard.	:SENS{1-16}:CORR:COLL:CLE
Cancel	Returns to the softkey display screen one level higher.	
Return	Returns to the softkey display screen one level higher.	
4-Port Cal* ²	Displays softkeys for executing full 4-port calibrations.	
Reflection	Displays softkeys for executing reflection calibrations.	
Port 1 Open	Executes an OPEN calibration on test port 1.	:SENS{1-16}:CORR:COLL:OPEN 1
Port 1 Short	Executes a SHORT calibration on test port 1.	:SENS{1-16}:CORR:COLL:SHOR 1
Port 1 Load	Executes a LOAD calibration on test port 1.	:SENS{1-16}:CORR:COLL:LOAD 1
Port 2 Open	Executes an OPEN calibration on test port 2.	:SENS{1-16}:CORR:COLL:OPEN 2
Port 2 Short	Executes a SHORT calibration on test port 2.	:SENS{1-16}:CORR:COLL:SHOR 2
Port 2 Load	Executes a LOAD calibration on test port 2.	:SENS{1-16}:CORR:COLL:LOAD 2
Port 3 Open	Executes an OPEN calibration on test port 3.	:SENS{1-16}:CORR:COLL:OPEN 3
Port 3 Short	Executes a SHORT calibration on test port 3.	:SENS{1-16}:CORR:COLL:SHOR 3
Port 3 Load	Executes a LOAD calibration on test port 3.	:SENS{1-16}:CORR:COLL:LOAD 3
Port 4 Open	Executes an OPEN calibration on test port 4.	:SENS{1-16}:CORR:COLL:OPEN 4
Port 4 Short	Executes a SHORT calibration on test port 4.	:SENS{1-16}:CORR:COLL:SHOR 4
Port 4 Load	Executes a LOAD calibration on test port 4.	:SENS{1-16}:CORR:COLL:LOAD 4
Return	Returns to the softkey display screen one level higher.	
Transmission	Displays softkeys for executing transmission calibrations.	
Port 1-2 Thru	Executes a THRU calibration between test ports 1 and 2.	:SENS{1-16}:CORR:COLL:THRU 1,2 :SENS{1-16}:CORR:COLL:THRU 2,1
Port 1-3 Thru	Executes a THRU calibration between test ports 1 and 3.	:SENS{1-16}:CORR:COLL:THRU 1,3 :SENS{1-16}:CORR:COLL:THRU 3,1
Port 1-4 Thru	Executes a THRU calibration between test ports 1 and 4.	:SENS{1-16}:CORR:COLL:THRU 1,4 :SENS{1-16}:CORR:COLL:THRU 4,1

Key Operation	Function	SCPI Command
Cal	(Continued)	
Calibrate		
4-Port Cal ^{*2}		
Transmission		
Port 2-3 Thru	Executes a THRU calibration between test ports 2 and 3.	:SENS{1-16}:CORR:COLL:THRU 2,3 :SENS{1-16}:CORR:COLL:THRU 3,2
Port 2-4 Thru	Executes a THRU calibration between test ports 2 and 4.	:SENS{1-16}:CORR:COLL:THRU 2,4 :SENS{1-16}:CORR:COLL:THRU 4,2
Port 3-4 Thru	Executes a THRU calibration between test ports 3 and 4.	:SENS{1-16}:CORR:COLL:THRU 3,4 :SENS{1-16}:CORR:COLL:THRU 4,3
Return	Returns to the softkey display screen one level higher.	
Isolation (Optional)	Displays softkeys for executing isolation calibrations.	
Port 1-2 Isol	Executes an isolation calibration on test ports 1 and 2.	:SENS{1-16}:CORR:COLL:ISOL 1,2 :SENS{1-16}:CORR:COLL:ISOL 2,1
Port 1-3 Isol	Executes an isolation calibration on test ports 1 and 3.	:SENS{1-16}:CORR:COLL:ISOL 1,3 :SENS{1-16}:CORR:COLL:ISOL 3,1
Port 1-4 Isol	Executes an isolation calibration on test ports 1 and 4.	:SENS{1-16}:CORR:COLL:ISOL 1,4 :SENS{1-16}:CORR:COLL:ISOL 4,1
Port 2-3 Isol	Executes an isolation calibration on test ports 2 and 3.	:SENS{1-16}:CORR:COLL:ISOL 2,3 :SENS{1-16}:CORR:COLL:ISOL 3,2
Port 2-4 Isol	Executes an isolation calibration on test ports 2 and 4.	:SENS{1-16}:CORR:COLL:ISOL 2,4 :SENS{1-16}:CORR:COLL:ISOL 4,2
Port 3-4 Isol	Executes an isolation calibration on test ports 3 and 4.	:SENS{1-16}:CORR:COLL:ISOL 3,4 :SENS{1-16}:CORR:COLL:ISOL 4,3
Return	Returns to the softkey display screen one level higher.	
Done	Terminates a calibration process and calculates the calibration coefficients.	:SENS{1-16}:CORR:COLL:SAVE
Overwrite	Terminates partial overwrite and recalculates the calibration coefficients.	:SENS{1-16}:CORR:COLL:PART:SAVE
Cancel	Displays softkeys for canceling a calibration.	
OK	Cancels a calibration process and clears the measurement data of standard.	:SENS{1-16}:CORR:COLL:CLE
Cancel	Returns to the softkey display screen one level higher.	
Return	Returns to the softkey display screen one level higher.	
Return	Returns to the softkey display screen one level higher.	
2-Port TRL Cal	Displays softkeys for executing 2-port TRL calibrations.	
Select Ports ^{*1}	Displays softkeys for selecting test ports.	
1-2	Selects test ports 1 and 2.	:SENS{1-16}:CORR:COLL:METH:TRL2 1,2
1-3	Selects test ports 1 and 3.	:SENS{1-16}:CORR:COLL:METH:TRL2 1,3
1-4 ^{*2}	Selects test ports 1 and 4.	:SENS{1-16}:CORR:COLL:METH:TRL2 1,4
2-3	Selects test ports 2 and 3.	:SENS{1-16}:CORR:COLL:METH:TRL2 2,3
2-4 ^{*2}	Selects test ports 2 and 4.	:SENS{1-16}:CORR:COLL:METH:TRL2 2,4
3-4 ^{*2}	Selects test ports 3 and 4.	:SENS{1-16}:CORR:COLL:METH:TRL2 3,4
Cancel	Returns to the softkey display screen one level higher.	

Softkey Functions Calibration Menu

Key Operation	Function	SCPI Command
Cal	(Continued)	
Calibrate		
2-Port TRL Cal		
Thru/Line	Displays softkeys for executing THRU/LINE calibrations. Symbols x and y refer to the two test ports selected in the Select Ports menu (x and y are always 1 and 2, respectively, for models with Option 213 or 214).	
x-y Thru/Line	Executes a THRU/LINE calibration on test ports x and y.	:SENS{1-16}:CORR:COLL:TRLT x,y :SENS{1-16}:CORR:COLL:TRLT y,x
Return	Returns to the softkey display screen one level higher.	
Reflect	Displays softkeys for executing reflection calibrations. Symbols x and y refer to the two test ports selected in the Select Ports menu (x and y are always 1 and 2, respectively, for models with Option 213 or 214).	
Port x Reflect	Executes a OPEN/SHORT reflection calibration on test port x.	:SENS{1-16}:CORR:COLL:TRLR x
Port y Reflect	Executes a OPEN/SHORT reflection calibration on test port y.	:SENS{1-16}:CORR:COLL:TRLR y
Return	Returns to the softkey display screen one level higher.	
Line/Match	Displays softkeys for executing LINE/MATCH calibrations. Symbols x and y refer to the two test ports selected in the Select Ports menu (x and y are always 1 and 2, respectively, for models with Option 213 or 214).	
x-y Line/Match	Executes a LINE/MATCH calibration on test ports x and y.	:SENS{1-16}:CORR:COLL:TRLL x,y :SENS{1-16}:CORR:COLL:TRLL y,x
x-y Fwd(Syx)	Executes a forward LINE/MATCH calibration on test ports x and y.	:SENS{1-16}:CORR:COLL:TRLL y,x
x-y Rvs(Sxy)	Executes a reverse LINE/MATCH calibration on test ports x and y.	:SENS{1-16}:CORR:COLL:TRLL x,y
Return	Returns to the softkey display screen one level higher.	
Done	Terminates a calibration process and calculates the calibration coefficients.	:SENS{1-16}:CORR:COLL:SAVE
Cancel	Displays softkeys for canceling a calibration.	
OK	Cancels a calibration process and clears the measurement data of standard.	:SENS{1-16}:CORR:COLL:CLE
Cancel	Returns to the softkey display screen one level higher.	
Return	Returns to the softkey display screen one level higher.	
3-Port TRL Cal ^{*1}	Displays softkeys for executing 3-port TRL calibrations.	
Select Ports ^{*2}	Displays softkeys for selecting test ports.	
1-2-3	Selects test ports 1, 2, and 3.	:SENS{1-16}:CORR:COLL:METH:TRL3 1,2,3
1-2-4	Selects test ports 1, 2, and 4.	:SENS{1-16}:CORR:COLL:METH:TRL3 1,2,4
1-3-4	Selects test ports 1, 3, and 4.	:SENS{1-16}:CORR:COLL:METH:TRL3 1,3,4
2-3-4	Selects test ports 2, 3, and 4.	:SENS{1-16}:CORR:COLL:METH:TRL3 2,3,4
Cancel	Returns to the softkey display screen one level higher.	
Thru/Line	Displays softkeys for executing THRU/LINE calibrations. Symbols x, y and z refer to the three test ports selected in the Select Ports menu (x, y, and z are always 1, 2, and 3, respectively, for models with Option 313 or 314).	
x-y Thru/Line	Executes a THRU/LINE calibration on test ports x and y.	:SENS{1-16}:CORR:COLL:TRLT x,y :SENS{1-16}:CORR:COLL:TRLT y,x
x-z Thru/Line	Executes a THRU/LINE calibration on test ports x and z.	:SENS{1-16}:CORR:COLL:TRLT x,z :SENS{1-16}:CORR:COLL:TRLT z,x
y-z Thru/Line	Executes a THRU/LINE calibration on test ports y and z.	:SENS{1-16}:CORR:COLL:TRLT y,z :SENS{1-16}:CORR:COLL:TRLT z,y
Return	Returns to the softkey display screen one level higher.	

Key Operation	Function	SCPI Command
Cal	(Continued)	
Calibrate		
3-Port TRL Cal* ¹		
Reflect	Displays softkeys for executing reflection calibrations. Symbols x, y and z refer to the three test ports selected in the Select Ports menu (x, y, and z are always 1, 2, and 3, respectively, for models with Option 313 or 314).	
Port x Reflect	Executes a OPEN/SHORT reflection calibration on test port x.	:SENS{1-16}:CORR:COLL:TRLR x
Port y Reflect	Executes a OPEN/SHORT reflection calibration on test port y.	:SENS{1-16}:CORR:COLL:TRLR y
Port z Reflect	Executes a OPEN/SHORT reflection calibration on test port z.	:SENS{1-16}:CORR:COLL:TRLR z
Return	Returns to the softkey display screen one level higher.	
Line/Match	Displays softkeys for executing LINE/MATCH calibrations. Symbols x, y, and z refer to the three test ports selected in the Select Ports menu (x, y, and z are always 1, 2, and 3 respectively, for models with Option 213 or 214).	
x-y Line/Match	Executes a LINE/MATCH calibration on test ports x and y.	:SENS{1-16}:CORR:COLL:TRLL x,y :SENS{1-16}:CORR:COLL:TRLL y,x
x-y Fwd(Syx)	Executes a forward LINE/MATCH calibration on test ports x and y.	:SENS{1-16}:CORR:COLL:TRLL y,x
x-y Rvs(Sxy)	Executes a reverse LINE/MATCH calibration on test ports x and y.	:SENS{1-16}:CORR:COLL:TRLL x,y
x-z Line/Match	Executes a LINE/MATCH calibration on test ports x and z.	:SENS{1-16}:CORR:COLL:TRLL x,z :SENS{1-16}:CORR:COLL:TRLL z,x
x-z Fwd(Szx)	Executes a forward LINE/MATCH calibration on test ports x and z.	:SENS{1-16}:CORR:COLL:TRLL z,x
x-z Rvs(Sxz)	Executes a reverse LINE/MATCH calibration on test ports x and z.	:SENS{1-16}:CORR:COLL:TRLL x,z
y-z Line/Match	Executes a LINE/MATCH calibration on test ports y and z.	:SENS{1-16}:CORR:COLL:TRLL y,z :SENS{1-16}:CORR:COLL:TRLL z,y
y-z Fwd(Szy)	Executes a forward LINE/MATCH calibration on test ports y and z.	:SENS{1-16}:CORR:COLL:TRLL z,y
y-z Rvs(Syz)	Executes a reverse LINE/MATCH calibration on test ports y and z.	:SENS{1-16}:CORR:COLL:TRLL y,z
Return	Returns to the softkey display screen one level higher.	
Done	Terminates a calibration process and calculates the calibration coefficients.	:SENS{1-16}:CORR:COLL:SAVE
Cancel	Displays softkeys for canceling a calibration.	
OK	Cancels a calibration process and clears the measurement data of standard.	:SENS{1-16}:CORR:COLL:CLE
Cancel	Returns to the softkey display screen one level higher.	
Return	Returns to the softkey display screen one level higher.	
4-Port TRL Cal* ²	Displays softkeys for executing 4-port TRL calibrations.	
Thru/Line	Displays softkeys for executing THRU/LINE calibrations.	
1-2 Thru/Line	Executes a THRU/LINE calibration for test port 1→2.	:SENS{1-16}:CORR:COLL:TRLT 1,2 :SENS{1-16}:CORR:COLL:TRLT 2,1
1-3 Thru/Line	Executes a THRU/LINE calibration for test port 1→3.	:SENS{1-16}:CORR:COLL:TRLT 1,3 :SENS{1-16}:CORR:COLL:TRLT 3,1
1-4 Thru/Line	Executes a THRU/LINE calibration for test port 1→4.	:SENS{1-16}:CORR:COLL:TRLT 1,4 :SENS{1-16}:CORR:COLL:TRLT 4,1
2-3 Thru/Line	Executes a THRU/LINE calibration for test port 2→3.	:SENS{1-16}:CORR:COLL:TRLT 2,3 :SENS{1-16}:CORR:COLL:TRLT 3,2
2-4 Thru/Line	Executes a THRU/LINE calibration for test port 2→4.	:SENS{1-16}:CORR:COLL:TRLT 2,4 :SENS{1-16}:CORR:COLL:TRLT 4,2
3-4 Thru/Line	Executes a THRU/LINE calibration for test port 3→4.	:SENS{1-16}:CORR:COLL:TRLT 3,4 :SENS{1-16}:CORR:COLL:TRLT 4,3
Return	Returns to the softkey display screen one level higher.	

Softkey Functions Calibration Menu

Key Operation	Function	SCPI Command
Cal	(Continued)	
Calibrate		
4-Port TRL Cal*2		
Reflect	Displays softkeys for executing reflection calibrations.	
Port 1 Reflect	Executes a OPEN/SHORT reflection calibration on test port 1.	:SENS{1-16}:CORR:COLL:TRLR 1
Port 2 Reflect	Executes a OPEN/SHORT reflection calibration on test port 2.	:SENS{1-16}:CORR:COLL:TRLR 2
Port 3 Reflect	Executes a OPEN/SHORT reflection calibration on test port 3.	:SENS{1-16}:CORR:COLL:TRLR 3
Port 4 Reflect	Executes a OPEN/SHORT reflection calibration on test port 4.	:SENS{1-16}:CORR:COLL:TRLR 4
Return	Returns to the softkey display screen one level higher.	
Line/Match	Displays softkeys for executing LINE/MATCH calibrations.	
1-2 Line/Match	Executes a LINE/MATCH calibration on test ports 1→2.	:SENS{1-16}:CORR:COLL:TRLL 1,2 :SENS{1-16}:CORR:COLL:TRLL 2,1
1-2 Fwd(S21)	Executes a forward LINE/MATCH calibration on test ports 1 and 2.	:SENS{1-16}:CORR:COLL:TRLL 2,1
1-2 Rvs(S12)	Executes a reverse LINE/MATCH calibration on test ports 1 and 2.	:SENS{1-16}:CORR:COLL:TRLL 1,2
1-3 Line/Match	Executes a LINE/MATCH calibration on test ports 1→3.	:SENS{1-16}:CORR:COLL:TRLL 1,3 :SENS{1-16}:CORR:COLL:TRLL 3,1
1-3 Fwd(S31)	Executes a forward LINE/MATCH calibration on test ports 1 and 3.	:SENS{1-16}:CORR:COLL:TRLL 3,1
1-3 Rvs(S13)	Executes a reverse LINE/MATCH calibration on test ports 1 and 3.	:SENS{1-16}:CORR:COLL:TRLL 1,3
1-4 Line/Match	Executes a LINE/MATCH calibration on test ports 1→4.	:SENS{1-16}:CORR:COLL:TRLL 1,4 :SENS{1-16}:CORR:COLL:TRLL 4,1
1-4 Fwd(S41)	Executes a forward LINE/MATCH calibration on test ports 1 and 4.	:SENS{1-16}:CORR:COLL:TRLL 4,1
1-4 Rvs(S14)	Executes a reverse LINE/MATCH calibration on test ports 1 and 4.	:SENS{1-16}:CORR:COLL:TRLL 1,4
2-3 Line/Match	Executes a LINE/MATCH calibration on test ports 2→3.	:SENS{1-16}:CORR:COLL:TRLL 2,3 :SENS{1-16}:CORR:COLL:TRLL 3,2
2-3 Fwd(S32)	Executes a forward LINE/MATCH calibration on test ports 2 and 3.	:SENS{1-16}:CORR:COLL:TRLL 3,2
2-3 Rvs(S23)	Executes a reverse LINE/MATCH calibration on test ports 2 and 3.	:SENS{1-16}:CORR:COLL:TRLL 2,3
2-4 Line/Match	Executes a LINE/MATCH calibration on test ports 2→4.	:SENS{1-16}:CORR:COLL:TRLL 2,4 :SENS{1-16}:CORR:COLL:TRLL 4,2
2-4 Fwd(S42)	Executes a forward LINE/MATCH calibration on test ports 2 and 4.	:SENS{1-16}:CORR:COLL:TRLL 4,2
2-4 Rvs(S24)	Executes a reverse LINE/MATCH calibration on test ports 2 and 4.	:SENS{1-16}:CORR:COLL:TRLL 2,4
3-4 Line/Match	Executes a LINE/MATCH calibration on test ports 3→4.	:SENS{1-16}:CORR:COLL:TRLL 3,4 :SENS{1-16}:CORR:COLL:TRLL 4,3
3-4 Fwd(S43)	Executes a forward LINE/MATCH calibration on test ports 3 and 4.	:SENS{1-16}:CORR:COLL:TRLL 4,3
3-4 Rvs(S34)	Executes a reverse LINE/MATCH calibration on test ports 3 and 4.	:SENS{1-16}:CORR:COLL:TRLL 3,4
Return	Returns to the softkey display screen one level higher.	
Done	Terminates a calibration process and calculates the calibration coefficients.	:SENS{1-16}:CORR:COLL:SAVE
Cancel	Displays softkeys for canceling a calibration.	
OK	Cancels a calibration process and clears the measurement data of standard.	:SENS{1-16}:CORR:COLL:CLE
Cancel	Returns to the softkey display screen one level higher.	
Return	Returns to the softkey display screen one level higher.	

Key Operation	Function	SCPI Command
Cal	(Continued)	
Calibrate		
Adapter Removal	Displays softkeys for executing adapter removal/insertion.	
Select Port	Displays softkeys for selecting a test port.	
1	Selects test port 1.	:SENS{1-16}:CORR:COLL:METH:ADAP:REM 1
2	Selects test port 2.	:SENS{1-16}:CORR:COLL:METH:ADAP:REM 2
3*1	Selects test port 3.	:SENS{1-16}:CORR:COLL:METH:ADAP:REM 3
4*2	Selects test port 4.	:SENS{1-16}:CORR:COLL:METH:ADAP:REM 4
Cancel	Returns to the softkey display screen one level higher.	
Cal Kit	Displays softkeys for selecting calibration kits.	:SENS{1-16}:CORR:COLL:CKIT
Open	Executes an OPEN calibration on the test port selected in the Select Port menu.	:SENS{1-16}:CORR:COLL:OPEN
Short	Executes a SHORT calibration on the test port selected in the Select Port menu.	:SENS{1-16}:CORR:COLL:SHOR
Load	Executes a LOAD calibration on the test port selected in the Select Port menu.	:SENS{1-16}:CORR:COLL:LOAD
Adapter Length	Sets the adapter length on the test port selected in the Select Port menu.	:SENS{1-16}:CORR:COLL:ADAP{1-4}:LENG
Done	Terminates a calibration process and calculates the calibration coefficients.	:SENS{1-16}:CORR:COLL:SAVE
Cancel	Displays softkeys for canceling a calibration.	
OK	Cancel a calibration process and clears the measurement data of standard.	:SENS{1-16}:CORR:COLL:CLE
Cancel	Returns to the softkey display screen one level higher.	
Return	Returns to the softkey display screen one level higher.	

Softkey Functions Calibration Menu

Key Operation	Function	SCPI Command
Cal	(Continued)	
ECal	Displays softkeys for executing ECal (Electronic Calibrations).	:CALC{1-16}:SEL:FORM GDEL
1-Port ECal	Displays softkeys for executing 1-port ECal	
Port 1	Executes a 1-port ECal on test port 1.	:SENS{1-16}:CORR:COLL:ECAL:SOLT1 1
Port 2	Executes a 1-port ECal on test port 2.	:SENS{1-16}:CORR:COLL:ECAL:SOLT1 2
Port 3^{*1}	Executes a 1-port ECal on test port 3.	:SENS{1-16}:CORR:COLL:ECAL:SOLT1 3
Port 4^{*2}	Executes a 1-port ECal on test port 4.	:SENS{1-16}:CORR:COLL:ECAL:SOLT1 4
Return	Returns to the softkey display screen one level higher.	
2-Port ECal	Options 213 and 214: Execute a 2-port ECal. Options 313, 314, 413, and 414: Display softkeys for executing a 2-port ECal.	
Port 1-2^{*1}	Executes a 2-port ECal on test ports 1 and 2.	:SENS{1-16}:CORR:COLL:ECAL:SOLT2 1,2
Port 1-3^{*1}	Executes a 2-port ECal on test ports 1 and 3.	:SENS{1-16}:CORR:COLL:ECAL:SOLT2 1,3
Port 1-4^{*2}	Executes a 2-port ECal on test ports 1 and 4.	:SENS{1-16}:CORR:COLL:ECAL:SOLT2 1,4
Port 2-3^{*1}	Executes a 2-port ECal on test ports 2 and 3.	:SENS{1-16}:CORR:COLL:ECAL:SOLT2 2,3
Port 2-4^{*2}	Executes a 2-port ECal on test ports 2 and 4.	:SENS{1-16}:CORR:COLL:ECAL:SOLT2 2,4
Port 3-4^{*2}	Executes a 2-port ECal on test ports 3 and 4.	:SENS{1-16}:CORR:COLL:ECAL:SOLT2 3,4
Return^{*1}	Returns to the softkey display screen one level higher.	
3-Port ECal	Options 313 and 314: Execute a 3-port ECal. Options 413 and 414: Display softkeys for executing a 3-port ECal.	
Port 1-2-3^{*2}	Executes a 3-port ECal on test ports 1, 2, and 3.	:SENS{1-16}:CORR:COLL:ECAL:SOLT3 1,2,3
Port 1-2-4^{*2}	Executes a 3-port ECal on test ports 1, 2, and 4.	:SENS{1-16}:CORR:COLL:ECAL:SOLT3 1,2,4
Port 1-3-4^{*2}	Executes a 3-port ECal on test ports 1, 3, and 4.	:SENS{1-16}:CORR:COLL:ECAL:SOLT3 1,3,4
Port 2-3-4^{*2}	Executes a 3-port ECal on test ports 2, 3, and 4.	:SENS{1-16}:CORR:COLL:ECAL:SOLT3 2,3,4
Return^{*2}	Returns to the softkey display screen one level higher.	
4-Port ECal^{*2}	Executes a 4-port ECal.	:SENS{1-16}:CORR:COLL:ECAL:SOLT4 1,2,3,4
Thru ECal	Displays softkeys for executing a THRU ECal.	
2-1 (S21)	Executes a THRU ECal for test port 1→2.	:SENS{1-16}:CORR:COLL:ECAL:THRU 2,1
3-1 (S31)^{*1}	Executes a THRU ECal for test port 1→3.	:SENS{1-16}:CORR:COLL:ECAL:THRU 3,1
4-1 (S41)^{*2}	Executes a THRU ECal for test port 1→4.	:SENS{1-16}:CORR:COLL:ECAL:THRU 4,1
1-2 (S12)	Executes a THRU ECal for test port 2→1.	:SENS{1-16}:CORR:COLL:ECAL:THRU 1,2
3-2 (S32)^{*1}	Executes a THRU ECal for test port 2→3.	:SENS{1-16}:CORR:COLL:ECAL:THRU 3,2
4-2 (S42)^{*2}	Executes a THRU ECal for test port 2→4.	:SENS{1-16}:CORR:COLL:ECAL:THRU 4,2
1-3 (S13)^{*1}	Executes a THRU ECal for test port 3→1.	:SENS{1-16}:CORR:COLL:ECAL:THRU 1,3
2-3 (S23)^{*1}	Executes a THRU ECal for test port 3→2.	:SENS{1-16}:CORR:COLL:ECAL:THRU 2,3
4-3 (S43)^{*2}	Executes a THRU ECal for test port 3→4.	:SENS{1-16}:CORR:COLL:ECAL:THRU 4,3
1-4 (S14)^{*2}	Executes a THRU ECal for test port 4→1.	:SENS{1-16}:CORR:COLL:ECAL:THRU 1,4
2-4 (S24)^{*2}	Executes a THRU ECal for test port 4→2.	:SENS{1-16}:CORR:COLL:ECAL:THRU 2,4
3-4 (S34)^{*2}	Executes a THRU ECal for test port 4→3.	:SENS{1-16}:CORR:COLL:ECAL:THRU 3,4
Return	Returns to the softkey display screen one level higher.	

Key Operation	Function	SCPI Command
Cal	(Continued)	
ECal		
Enhanced Response	Displays softkeys for executing an ENHANCED RESPONSE ECal.	
2-1 (S21 S11)	Executes a THRU ECal for test port 1→2.	:SENS{1-16}:CORR:COLL:ECAL:ERES 2,1
3-1 (S31 S11)* ¹	Executes a THRU ECal for test port 1→3.	:SENS{1-16}:CORR:COLL:ECAL:ERES 3,1
4-1 (S41 S11)* ²	Executes a THRU ECal for test port 1→4.	:SENS{1-16}:CORR:COLL:ECAL:ERES 4,1
1-2 (S12 S22)	Executes a THRU ECal for test port 2→1.	:SENS{1-16}:CORR:COLL:ECAL:ERES 1,2
3-2 (S32 S22)* ¹	Executes a THRU ECal for test port 2→3.	:SENS{1-16}:CORR:COLL:ECAL:ERES 3,2
4-2 (S42 S22)* ²	Executes a THRU ECal for test port 2→4.	:SENS{1-16}:CORR:COLL:ECAL:ERES 4,2
1-3 (S13 S33)* ¹	Executes a THRU ECal for test port 3→1.	:SENS{1-16}:CORR:COLL:ECAL:ERES 1,3
2-3 (S23 S33)* ¹	Executes a THRU ECal for test port 3→2.	:SENS{1-16}:CORR:COLL:ECAL:ERES 2,3
4-3 (S43 S33)* ²	Executes a THRU ECal for test port 3→4.	:SENS{1-16}:CORR:COLL:ECAL:ERES 4,3
1-4 (S14 S44)* ²	Executes a THRU ECal for test port 4→1.	:SENS{1-16}:CORR:COLL:ECAL:ERES 1,4
2-4 (S24 S44)* ²	Executes a THRU ECal for test port 4→2.	:SENS{1-16}:CORR:COLL:ECAL:ERES 2,4
3-4 (S34 S44)* ²	Executes a THRU ECal for test port 4→3.	:SENS{1-16}:CORR:COLL:ECAL:ERES 3,4
Return	Returns to the softkey display screen one level higher.	
Isolation	Enables or disables isolation calibration.	:SENS{1-16}:CORR:COLL:ECAL:ISOL
Unknown Thru	Enables or disables unknown thru calibration.	:SENS{1-16}:CORR:COLL:ECAL:UTHR
Characterization	Displays softkeys for selecting the ECal characteristic.	
Factory	Selects the factory-default characteristic.	:SENS{1-16}:CORR:COLL:ECAL:UCH CHAR0
User1	Selects the characteristic stored at location number 1 in the ECal's flash memory.	:SENS{1-16}:CORR:COLL:ECAL:UCH CHAR1
User2	Selects the characteristic stored at location number 2 in the ECal's flash memory.	:SENS{1-16}:CORR:COLL:ECAL:UCH CHAR2
User3	Selects the characteristic stored at location number 3 in the ECal's flash memory.	:SENS{1-16}:CORR:COLL:ECAL:UCH CHAR3
User4	Selects the characteristic stored at location number 4 in the ECal's flash memory.	:SENS{1-16}:CORR:COLL:ECAL:UCH CHAR4
User5	Selects the characteristic stored at location number 5 in the ECal's flash memory.	:SENS{1-16}:CORR:COLL:ECAL:UCH CHAR5
Cancel	Returns to the softkey display screen one level higher.	
Characterization Info	Displays the information of the selected ECal characteristic.	None
Confidence Check	Executes the confidence check of the calibration coefficients.	:SENS{1-16}:CORR:COLL:ECAL:CCH
Orientation		
Port 1	Selects port 1.	
Port A	Selects port A as port 1.	:SENS{1-16}:CORR:COLL:ECAL:PATH 1,1
Port B	Selects port B as port 1.	:SENS{1-16}:CORR:COLL:ECAL:PATH 1,2
Port C	Selects port C as port 1.	:SENS{1-16}:CORR:COLL:ECAL:PATH 1,3
Port D	Selects port D as port 1.	:SENS{1-16}:CORR:COLL:ECAL:PATH 1,4
Return	Returns to the softkey display screen one level higher.	
Port 2	Selects port 2.	
Port A	Selects port A as port 2.	:SENS{1-16}:CORR:COLL:ECAL:PATH 2,1

Softkey Functions Calibration Menu

Key Operation	Function	SCPI Command
Cal	(Continued)	
ECal		
Orientation		
Port 2	Selects port 2.	
Port B	Selects port B as port 2.	:SENS{1-16}:CORR:COLL:ECAL:PATH 2,2
Port C	Selects port C as port 2.	:SENS{1-16}:CORR:COLL:ECAL:PATH 2,3
Port D	Selects port D as port 2.	:SENS{1-16}:CORR:COLL:ECAL:PATH 2,4
Return	Returns to the softkey display screen one level higher.	
Port 3	Selects port 3.	
Port A	Selects port A as port 3.	:SENS{1-16}:CORR:COLL:ECAL:PATH 3,1
Port B	Selects port B as port 3.	:SENS{1-16}:CORR:COLL:ECAL:PATH 3,2
Port C	Selects port C as port 3.	:SENS{1-16}:CORR:COLL:ECAL:PATH 3,3
Port D	Selects port D as port 3.	:SENS{1-16}:CORR:COLL:ECAL:PATH 3,4
Return	Returns to the softkey display screen one level higher.	
Port 4	Selects port 4.	
Port A	Selects port A as port 4.	:SENS{1-16}:CORR:COLL:ECAL:PATH 4,1
Port B	Selects port B as port 4.	:SENS{1-16}:CORR:COLL:ECAL:PATH 4,2
Port C	Selects port C as port 4.	:SENS{1-16}:CORR:COLL:ECAL:PATH 4,3
Port D	Selects port D as port 4.	:SENS{1-16}:CORR:COLL:ECAL:PATH 4,4
Return	Returns to the softkey display screen one level higher.	
Return	Returns to the softkey display screen one level higher.	
Clear	Displays the softkey that clears the calibration coefficient except for the scalar-mixer calibration coefficient.	
OK	Clears all the calibration coefficient.	:SENS{1-16}:CORR:CLE
Cancel	Returns to the softkey display screen one level higher.	
Property	Enables or disables the display of calibration property. When enabled, calibration status information between test ports will be displayed in a matrix format in the lower-right corner of the channel window.	:SENS{1-16}:CORR:PROP
Cal Kit	Displays softkeys for selecting calibration kits. Up to twenty calibration kits may be defined. Calibration kits 85033E, 85033D, 85052D, 85032F, 85032B, 85036B/E, 85031B, 85050C/D, 85052C and 85038A/F/M are pre-defined with default settings.	
85033E	Selects calibration kit 85033E.	:SENS{1-16}:CORR:COLL:CKIT 1
85033D	Selects calibration kit 85033D.	:SENS{1-16}:CORR:COLL:CKIT 2
85052D	Selects calibration kit 85052D.	:SENS{1-16}:CORR:COLL:CKIT 3
85032F	Selects calibration kit 85032F.	:SENS{1-16}:CORR:COLL:CKIT 4
85032B	Selects calibration kit 85032B.	:SENS{1-16}:CORR:COLL:CKIT 5
85036B/E	Selects calibration kit 85036B/E.	:SENS{1-16}:CORR:COLL:CKIT 6
85031B	Selects calibration kit 85031B.	:SENS{1-16}:CORR:COLL:CKIT 7
85050C/D	Selects calibration kit 85050C/D.	:SENS{1-16}:CORR:COLL:CKIT 8
85052C	Selects calibration kit 85052C.	:SENS{1-16}:CORR:COLL:CKIT 9
85038A/F/M	Selects calibration kit 85038A/F/M.	:SENS{1-16}:CORR:COLL:CKIT 10
User	Selects calibration kit User.	:SENS{1-16}:CORR:COLL:CKIT 11
:	:	
User	Selects calibration kit User.	:SENS{1-16}:CORR:COLL:CKIT 20
Cancel	Returns to the softkey display screen one level higher.	

Key Operation	Function	SCPI Command
Cal	(Continued)	
Modify Cal Kit	Displays softkeys for changing the definition of the calibration kit selected in the Cal Kit menu.	CALC{1-16}:SEL:FORM SCOM
Define STDs	Displays softkeys for defining the standard for a calibration kit. The label (Std Name) on each softkey represents the name of each standard. As a default setting, undefined standards are tagged with a No Name label. Up to 21 standards may be defined.	
1. (Std Name)	Displays softkeys for changing the definition of 1. (Std Name) .	
Label	Defines the name of the standard No.1. Once named, the new name will appear as a label for the corresponding softkey, which is represented as (Std Name) in this manual.	:SENS{1-16}:CORR:COLL:CKIT:STAN1:LAB
STD Type	Displays softkeys for setting the types of standards. A standard type is a classification of a standard based on its form and construction. There are five standard types: OPEN, SHORT, LOAD, delay/THRU, and arbitrary impedance.	
Open	Selects "OPEN" as the standard type.	:SENS{1-16}:CORR:COLL:CKIT:STAN1:TYPE OPEN
Short	Selects "SHORT" as the standard type.	:SENS{1-16}:CORR:COLL:CKIT:STAN1:TYPE SHOR
Load	Selects "LOAD" as the standard type.	:SENS{1-16}:CORR:COLL:CKIT:STAN1:TYPE LOAD
Delay/ Thru	Selects "delay/THRU" as the standard type.	:SENS{1-16}:CORR:COLL:CKIT:STAN1:TYPE THRU
Arbitrary	Selects "arbitrary impedance" as the standard type.	:SENS{1-16}:CORR:COLL:CKIT:STAN1:TYPE ARBI
None	Does not select any standard type.	:SENS{1-16}:CORR:COLL:CKIT:STAN1:TYPE NONE
Cancel	Returns to the softkey display screen one level higher.	
C0	Sets the value of C0 (F) for the standard. The fringe capacitance (F) of a standard is determined by the following formula: $C = (C0) + (C1 \times F) + (C2 \times F^2) + (C3 \times F^3)$ (F: measurement frequency [Hz])	:SENS{1-16}:CORR:COLL:CKIT:STAN1:C0
C1	Sets the value of C1 (F/Hz) for the standard.	:SENS{1-16}:CORR:COLL:CKIT:STAN1:C1
C2	Sets the value of C2 (F/Hz ²) for the standard.	:SENS{1-16}:CORR:COLL:CKIT:STAN1:C2
C3	Sets the value of C3 (F/Hz ³) for the standard.	:SENS{1-16}:CORR:COLL:CKIT:STAN1:C3
L0	Sets the value of L0 (H) for the standard. The residual inductance (H) of a standard is determined by the following formula: $L = (L0) + (L1 \times F) + (L2 \times F^2) + (L3 \times F^3)$ (F: measurement frequency [Hz])	:SENS{1-16}:CORR:COLL:CKIT:STAN1:L0
L1	Sets the value of L1 (H/Hz) for the standard.	:SENS{1-16}:CORR:COLL:CKIT:STAN1:L1
L2	Sets the value of L2 (H/Hz ²) for the standard.	:SENS{1-16}:CORR:COLL:CKIT:STAN1:L2
L3	Sets the value of L3 (H/Hz ³) for the standard.	:SENS{1-16}:CORR:COLL:CKIT:STAN1:L3
Offset Delay	Sets the offset delay (sec.) for the standard. The offset delay is a delay caused by the length of the transmission line between the standard to be defined and the actual measurement plane. For the OPEN, SHORT, and LOAD standards, input the one-way transmission time (sec.) from the measurement plane to the standard. For the THRU standard, input the one-way transmission time (sec.) from one measurement plane to the other. The offset delay can be obtained either by measuring it or by dividing the exact physical length of the standard by the velocity factor.	:SENS{1-16}:CORR:COLL:CKIT:STAN1:DEL

Softkey Functions Calibration Menu

Key Operation	Function	SCPI Command
Cal	(Continued)	
Modify Cal Kit		
Define STDs		
1. (Std Name)		
Offset Z0	Sets the impedance Z0 between the measurement plane and the standard being defined. Normally, this value is set to the characteristic impedance of the system.	:SENS{1-16}:CORR:COLL:CKIT:STAN1:Z0
Offset Loss	Sets the offset loss for the standard. The offset loss is an energy loss due to skin effect on the length of single coaxial cable. Input the energy loss at 1 GHz using the unit W/sec. In most applications, setting the offset loss to "0" should not affect the result. The offset loss of a standard can be determined by measuring the offset delay and the loss at 1 GHz and then substituting them in the following formula: $\text{Loss}(\Omega/\text{s}) = \frac{\text{loss}(\text{dB}) \times Z_0(\Omega)}{4.3429(\text{dB}) \times \text{delay}(\text{s})}$:SENS{1-16}:CORR:COLL:CKIT:STAN1:LOSS
Arb. Impedance	Sets the value for the LOAD standard. Use this option to input an arbitrary impedance that is different from the system impedance.	:SENS{1-16}:CORR:COLL:CKIT:STAN1:ARB
Min. Frequency	Sets the minimum frequency for the standard.	:SENS{1-16}:CORR:COLL:CKIT:STAN1:FMIN
Max. Frequency	Sets the maximum frequency for the standard.	:SENS{1-16}:CORR:COLL:CKIT:STAN1:FMAX
Media	Sets the media type of the standard.	:SENS{1-16}:CORR:COLL:CKIT:STAN1:CHAR
Return	Returns to the softkey display screen one level higher.	
2. (Std Name)	Displays softkeys for changing the definition of 2. (Std Name). The lower-level softkeys displayed are the same as those for 1. (Std Name).	
.	.	
21. (Std Name)	Displays softkeys for changing the definition of 21. (Std Name). The lower-level softkeys displayed are the same as those for 1. (Std Name).	
Return	Returns to the softkey display screen one level higher.	
Specify CLSs	Displays softkeys for setting the classes of standard. A standard class refers to a set of standards that are used in the process of calibration. For each class of OPEN, SHORT, LOAD, and THRU, designate standards to be used from among the 21 standards.	
Sub Class	Displays softkeys for setting multiple calibration kits.	
Sub Class 1	Selects sub class 1.	:SENS{1-16}:CORR:COLL:CKIT:ORD 1
.	.	
Sub Class 8	Selects sub class 8.	:SENS{1-16}:CORR:COLL:CKIT:ORD 8

Key Operation	Function	SCPI Command
Cal	(Continued)	
Modify Cal Kit		
Specify CLSs		
Open	Displays softkeys for selecting standards for the OPEN standard class.	
Set All	Displays softkeys for selecting standards for the OPEN standard class that applies to	
None	Does not include 1. (Std Name) in the OPEN standard class.	:SENS{1-16}:CORR:COLL:CKIT:ORD:THRU x,y,0
1. (Std Name)	Includes 1. (Std Name) in the OPEN standard class.	:SENS{1-16}:CORR:COLL:CKIT:ORD:OPEN x,1
2. (Std Name)	Includes 2. (Std Name) in the OPEN standard class.	:SENS{1-16}:CORR:COLL:CKIT:ORD:OPEN x,2
.	.	.
21. (Std Name)	Includes 21. (Std Name) in the OPEN standard class.	:SENS{1-16}:CORR:COLL:CKIT:ORD:OPEN x,21
Cancel	Returns to the softkey display screen one level higher.	
Port 1	Displays softkeys for selecting standards for the OPEN standard class that applies only to test port 1. The lower-level softkeys are the same as those for Set All.	
Port 2	Displays softkeys for selecting standards for the OPEN standard class that applies only to test port 2. The lower-level softkeys are the same as those for Set All.	
Port 3 ^{*1}	Displays softkeys for selecting standards for the OPEN standard class that applies only to test port 3. The lower-level softkeys are the same as those for Set All.	
Port 4 ^{*2}	Displays softkeys for selecting standards for the OPEN standard class that applies only to test port 4. The lower-level softkeys are the same as those for Set All.	
Return	Returns to the softkey display screen one level higher.	
Short	Displays softkeys for selecting standards for the SHORT standard class. The lower-level softkeys displayed are the same as those for Open.	:SENS{1-16}:CORR:COLL:CKIT:ORD:SHOR
Load	Displays softkeys for selecting standards for the LOAD standard class. The lower-level softkeys displayed are the same as those for Open.	:SENS{1-16}:CORR:COLL:CKIT:ORD:LOAD

Softkey Functions Calibration Menu

Key Operation	Function	SCPI Command
Cal	(Continued)	
Modify Cal Kit		
Specify CLSs		
Thru	Displays softkeys for setting the THRU standard class.	
Set All	Displays softkeys for selecting standard for the THRU standard class that applies to all test ports.	
None	Does not include 1. (Std Name) in the THRU standard class.	:SENS{1-16}:CORR:COLL:CKIT:ORD:THRU x,y,0
1. (Std Name)	Includes 2. (Std Name) in the THRU standard class.	:SENS{1-16}:CORR:COLL:CKIT:ORD:THRU x,y,1
.	.	.
21. (Std Name)	Includes 21.(Std Name) in the THRU standard class.	:SENS{1-16}:CORR:COLL:CKIT:ORD:THRU x,y,21
Cancel	Returns to the softkey display screen one level higher.	
Port 1-2	Displays softkeys for selecting standards for the THRU standard class that applies to test ports 1 and 2. The lower-level softkeys are the same as those for Set All.	
Port 1-3	Displays softkeys for selecting standards for the THRU standard class that applies to test ports 1 and 3. The lower-level softkeys are the same as those for Set All.	
Port 1-4	Displays softkeys for selecting standards for the THRU standard class that applies to test ports 1 and 4. The lower-level softkeys are the same as those for Set All.	
Port 2-3	Displays softkeys for selecting standards for the THRU standard class that applies to test ports 2 and 3. The lower-level softkeys are the same as those for Set All.	
Port 2-4	Displays softkeys for selecting standards for the THRU standard class that applies to test ports 2 and 4. The lower-level softkeys are the same as those for Set All.	
Port 3-4	Displays softkeys for selecting standards for the THRU standard class that applies to test ports 3 and 4. The lower-level softkeys are the same as those for Set All.	
Return	Returns to the softkey display screen one level higher.	
TRL Thru	Displays softkeys for setting the TRL THRU standard. The lower-level softkeys displayed are the same as those for Thru.	:SENS{1-16}:CORR:COLL:CKIT:ORD:TRLT
TRL Reflect		
None	Does not include 1. (Std Name) in the TRL reflection standard class.	:SENS{1-16}:CORR:COLL:CKIT:ORD:TRLR 0
1. (Std Name)	Includes 1. (Std Name) in the TRL reflection standard class.	:SENS{1-16}:CORR:COLL:CKIT:ORD:TRLR 1
.	.	.
21. (Std Name)	Includes 21. (Std Name) in the TRL reflection standard class.	:SENS{1-16}:CORR:COLL:CKIT:ORD:TRLR 21
Cancel	Returns to the softkey display screen one level higher.	
TRL Line/Match	Displays softkeys for setting the TRL LINE/MATCH standard. The lower-level softkeys displayed are the same as those for Thru.	:SENS{1-16}:CORR:COLL:CKIT:ORD:TRL
Return	Returns to the softkey display screen one level higher.	
TRL Option	Displays softkeys for setting the TRL calibration.	
Impedance	Selects the reference impedance.	:SENS{1-16}:CORR:COLL:CKIT:TRL:IMP
Reference Plane	Selects the measurement data for the standard used to calculate the reference plane.	:SENS{1-16}:CORR:COLL:CKIT:TRL:RPL
Return	Returns to the softkey display screen one level higher.	

Key Operation	Function	SCPI Command
Cal	(Continued)	
Modify Cal Kit		
Label Kit	Allows the user to label the calibration kit.	:SENS{1-16}:CORR:COLL:CKIT:LAB
Restore Cal Kit	Displays softkeys for initializing the definition of calibration kit.	
OK	Restores the definition of the calibration kit selected by Cal Kit to factory default settings.	:SENS{1-16}:CORR:COLL:CKIT:RES
Cancel	Returns to the softkey display screen one level higher.	
Export Cal Kit...	Exports the contents of the calibration kit to a file.	:MMEM:STOR:CKIT{1-20}
Import Cal Kit...	Imports a saved calibration kit file.	:MMEM:LOAD:CKIT{1-20}
Return	Returns to the softkey display screen one level higher.	
Port Extensions	Displays softkeys for extending ports.	
Auto Port Extension	Displays softkeys for setting the auto port extension.	
Select Ports	Displays softkeys for selecting the test port with which you want to perform the auto port extension.	
Port 1	Selects test port 1	:SENS{1-16}:CORR:EXT:AUTO:PORT 1
Port 2	Selects test port 2	:SENS{1-16}:CORR:EXT:AUTO:PORT 2
Port 3	Selects test port 3	:SENS{1-16}:CORR:EXT:AUTO:PORT 3
Port 4	Selects test port 4	:SENS{1-16}:CORR:EXT:AUTO:PORT 4
Return	Returns to the softkey display screen one level higher.	
Measure OPEN	Executes the measurement of the open standard.	
All	Executes the measurement for all the selected ports.	:SENS{1-16}:CORR:EXT:AUTO:MEAS OPEN
Port 1	Executes the measurement for test port 1.	:SENS{1-16}:CORR:EXT:AUTO:MEAS OPEN
Port 2	Executes the measurement for test port 2.	:SENS{1-16}:CORR:EXT:AUTO:MEAS OPEN
Port 3	Executes the measurement for test port 3.	:SENS{1-16}:CORR:EXT:AUTO:MEAS OPEN
Port 4	Executes the measurement for test port 4.	:SENS{1-16}:CORR:EXT:AUTO:MEAS OPEN
Return	Returns to the softkey display screen one level higher.	
Measure SHORT	Executes the measurement of the short standard.	
All	Executes the measurement for all the selected ports.	:SENS{1-16}:CORR:EXT:AUTO:MEAS SHOR
Port 1	Executes the measurement for test port 1.	:SENS{1-16}:CORR:EXT:AUTO:MEAS SHOR
Port 2	Executes the measurement for test port 2.	:SENS{1-16}:CORR:EXT:AUTO:MEAS SHOR
Port 3	Executes the measurement for test port 3.	:SENS{1-16}:CORR:EXT:AUTO:MEAS SHOR
Port 4	Executes the measurement for test port 4.	:SENS{1-16}:CORR:EXT:AUTO:MEAS SHOR
Return	Returns to the softkey display screen one level higher.	
Method	Sets the frequency calculated by the auto port extension function.	
Current Span	Sets the current sweep range.	:SENS{1-16}:CORR:EXT:AUTO:CONF CSPN
Active Marker	Sets the frequency of the active marker.	:SENS{1-16}:CORR:EXT:AUTO:CONF AMKR
User Span	Sets the arbitrary start value and stop value.	:SENS{1-16}:CORR:EXT:AUTO:CONF USPN
User Span Start	Sets the start value.	:SENS{1-16}:CORR:EXT:AUTO:STAR
User Span Stop	Sets the stop value.	:SENS{1-16}:CORR:EXT:AUTO:STOP
Return	Returns to the softkey display screen one level higher.	

Softkey Functions Calibration Menu

Key Operation	Function	SCPI Command
Cal	(Continued)	
Port Extensions		
Auto Port Extension		
Adjust Mismatch	Enables/disables the function to use the DC loss value for the calculation.	:SENS{1-16}:CORR:EXT:AUTO:DCOF
Include	Enables/disables the loss value calculation.	:SENS{1-16}:CORR:EXT:AUTO:LOSS
Return	Returns to the softkey display screen one level higher.	
Extensions	Enables or disables the port extension function.	:SENS{1-16}:CORR:EXT
Extension Port 1	Sets the value for test port 1 extension (sec.).	:SENS{1-16}:CORR:EXT:PORT 1
Extension Port 2	Sets the value for test port 2 extension (sec.).	:SENS{1-16}:CORR:EXT:PORT 2
Extension Port 3*1	Sets the value for test port 3 extension (sec.).	:SENS{1-16}:CORR:EXT:PORT 3
Extension Port 4*2	Sets the value for test port 4 extension (sec.).	:SENS{1-16}:CORR:EXT:PORT 4
Loss	Sets the loss value.	
Select Ports	Display the softkey to select the test port.	
Port 1	Select test port 1.	None
Port 2	Select test port 2.	None
Port 3	Select test port 3.	None
Port 4	Select test port 4.	None
Return	Returns to the softkey display screen one level higher.	
Loss1	Toggles on/off loss 1 on the selected port.	:SENS{1-16}:CORR:EXT:PORT{1-4}:INCL1
Loss1	Sets the loss value of loss 1 on the selected port.	:SENS{1-16}:CORR:EXT:PORT{1-4}:LOSS1
Freq1	Sets the frequency of loss 1 on the selected port.	:SENS{1-16}:CORR:EXT:PORT{1-4}:FREQ1
Loss2	Toggles on/off the loss 2 on the selected port.	:SENS{1-16}:CORR:EXT:PORT{1-4}:INCL2
Loss2	Sets the loss value of the loss 2 on the selected port.	:SENS{1-16}:CORR:EXT:PORT{1-4}:LOSS2
Freq2	Sets the frequency of the loss 2 on the selected port.	:SENS{1-16}:CORR:EXT:PORT{1-4}:FREQ2
Loss at DC	Sets the DC loss value.	:SENS{1-16}:CORR:EXT:PORT{1-4}:LDC
Return	Returns to the softkey display screen one level higher.	
Return	Returns to the softkey display screen one level higher.	
Velocity Factor	Sets the velocity factor.	:SENS{1-16}:CORR:RVEL:COAX
Set Z0	Sets the system characteristic impedance value.	:SENS:CORR:IMP

Key Operation	Function	SCPI Command
Cal	(Continued)	
Power Calibration	Displays the softkey to execute the power calibration.	
Select Port	Displays the softkey to select the test port you want to calibrate.	
1	Selects test port 1.	None
2	Selects test port 2.	None
3	Selects test port 3.	None
4	Selects test port 4.	None
Cancel	Returns to the softkey display screen one level higher.	
Correction	Toggles on/off the power level error correction.	:SOUR{1-16}:POW:PORT{1-4}:CORR
Take Cal Sweep	Executes the measurement of power calibration data.	:SOUR{1-16}:POW:PORT{1-4}:CORR:COLL
Abort	Aborts the measurement of power calibration data.	None
Use Sensor	Selects the channel of the power sensor you want to use for the measurement of power calibration data.	None
Num of Readings	Sets the number of power level measurements per measurement point (averaging factor).	:SOUR{1-16}:POW:PORT{1-4}:CORR:COLL:A VER
Tolerance	Sets the tolerance for power calibration.	:SOUR:POW:PORT{1-4}:CORR:COLL:NTOL
Loss Compen	Displays the softkey to set the loss correction.	
Compensation	Toggles on/off the loss correction.	:SOUR{1-16}:POW:PORT{1-4}:CORR:COLL:T ABL:LOSS
Delete	Deletes the cursor line on the loss correction table.	:SOUR{1-16}:POW:PORT{1-4}:CORR:COLL:T ABL:LOSS:DATA
Add	Inserts a new segment above the cursor line on the loss correction table.	:SOUR{1-16}:POW:PORT{1-4}:CORR:COLL:T ABL:LOSS:DATA
Clear Loss Table	Displays the softkey to clear the loss correction table.	
OK	Deletes all segments in the loss correction table.	None
Cancel	Returns to the softkey display in one level higher.	
Export to CSV File	Exports (writes in another software format) the content of the loss correction table as a CSV (comma separated value) format file.	:MMEM:STOR:PLOS{1-4}
Import from CSV File	Imports a saved CSV (comma separated value) format file into the loss correction table.	:MMEM:LOAD:PLOS{1-4}
Return	Returns to the softkey display in one level higher.	
Sensor A Settings	Displays the softkey to set the calibration coefficient for the power sensor connected to channel A.	
Ref Cal Factor	Sets the value of the reference calibration coefficient.	:SOUR:POW:PORT:CORR:COLL:ASEN:RCF
Delete	Deletes the cursor line on the calibration coefficient table.	:SOUR:POW:PORT:CORR:COLL:TABL:ASEN: DATA
Add	Inserts a new segment above the cursor line on the calibration coefficient table.	:SOUR:POW:PORT:CORR:COLL:TABL:ASEN: DATA
Clear Loss Table	Displays the softkey to clear the calibration coefficient table.	
OK	Deletes all segments in the calibration coefficient table.	None
Cancel	Returns to the softkey display in one level higher.	
Export to CSV File	Exports (writes in another software format) the content of the calibration coefficient table as a CSV (comma separated value) format file.	:MMEM:STOR:ASCF
Import from CSV File	Imports a saved CSV (comma separated value) format file into the calibration coefficient table.	:MMEM:LOAD:ASCF
Return	Returns to the softkey display in one level higher.	

Softkey Functions Calibration Menu

Key Operation	Function	SCPI Command
Cal	(Continued)	
Power Calibration	Displays the softkey to execute the power calibration.	
Sensor B Settings	Displays the softkey to set the calibration coefficient for the power sensor connected to channel B.	
Ref Cal Factor	Sets the value of the reference calibration coefficient.	:SOUR:POW:PORT:CORR:COLL:BSEN:RCF
Delete	Deletes the cursor line on the calibration coefficient table.	:SOUR:POW:PORT:CORR:COLL:TABL:BSEN:DATA
Add	Inserts a new segment above the cursor line on the calibration coefficient table.	:SOUR:POW:PORT:CORR:COLL:TABL:BSEN:DATA
Clear Loss Table	Displays the softkey to clear the calibration coefficient table.	
OK	Deletes all segments in the calibration coefficient table.	None
Cancel	Returns to the softkey display in one level higher.	
Export to CSV File	Exports (writes in another software format) the content of the calibration coefficient table as a CSV (comma separated value) format file.	:MMEM:STOR:BSCF
Import from CSV File	Imports a saved CSV (comma separated value) format file into the calibration coefficient table.	:MMEM:LOAD:BSCF
Return	Returns to the softkey display one level higher.	
Return	Returns to the softkey display screen one level higher.	
Receiver Calibration	Displays the softkey to execute the receiver calibration.	
Select Port	Displays the softkey to select the test port you want to calibrate.	
1	Selects test port 1.	None
2	Selects test port 2.	None
3	Selects test port 3.	None
4	Selects test port 4.	None
Cancel	Returns to the softkey display screen one level higher.	
Correction	Enables or disables error correction.	:SENS{1-16}:CORR:REC{1-4}
Source Port	Displays the softkey to select the source port you want to use for receiver calibration.	
1	Selects test port 1 as the source port.	None
2	Selects test port 2 as the source port.	None
3	Selects test port 3 as the source port.	None
4	Selects test port 4 as the source port.	None
Cancel	Returns to the softkey display screen one level higher.	
Take Cal Sweep	Executes the measurement of receiver calibration data.	:SENS{1-16}:CORR:REC{1-4}:COLL:ACQ
Return	Returns to the softkey display screen one level higher.	

Key Operation	Function	SCPI Command
Cal	(Continued)	
Mixer/Converter Calibration	Displays the softkey to execute a scalar-mixer calibration.	
Scalar Cal (Manual)	Displays the softkey to execute a scalar-mixer calibration by using the calibration kits.	
Select Ports	Displays the softkey to select test ports and calibration methods you want to use.	
Port 1	Select 1-port calibration for the test port 1.	:SENS{1-16}:CORR:OFFS:COLL:METH: SOLT1
:	:	:
Port 4*2	Select 1-port calibration for the test port 4.	:SENS{1-16}:CORR:OFFS:COLL:METH: SOLT1
2-1 (fwd)	Select a scalar-mixer calibration for test port 1→2 (forward).	:SENS{1-16}:CORR:OFFS:COLL:METH: SMIX2
1-2 (rev)	Select a scalar-mixer calibration for test port 2→1 (reverse).	:SENS{1-16}:CORR:OFFS:COLL:METH: SMIX2
2,1 (both)	Select a scalar-mixer calibration for test port 1→2 and 2→1 (both directions).	:SENS{1-16}:CORR:OFFS:COLL:METH: SMIX2
:	:	:
4-3 (fwd)*2	Select a scalar-mixer calibration for test port 3→4 (forward).	:SENS{1-16}:CORR:OFFS:COLL:METH: SMIX2
3-4 (rev)*2	Select a scalar-mixer calibration for test port 4→3 (reverse).	:SENS{1-16}:CORR:OFFS:COLL:METH: SMIX2
3,4 (both)*2	Select a scalar-mixer calibration for test port 3→4 and 4→3 (both directions).	:SENS{1-16}:CORR:OFFS:COLL:METH: SMIX2
Cancel	Returns to the softkey display in one level higher.	
Reflection	Displays the softkey to execute standard (OPEN, SHORT, and LOAD) measurements.	
Port x @ Freq x [Open]	Executes an OPEN reflection calibration on test port x by using the frequency that is set in test port x. The x changes by the selected test port and calibration method.	:SENS{1-16}:CORR:OFFS:COLL:OPEN
Port x @ Freq y [Open]	Executes an OPEN reflection calibration on test port x by using the frequency that is set in test port y. The x and y change by the selected test port and calibration method.	:SENS{1-16}:CORR:OFFS:COLL:OPEN
Port x @ Freq x [Short]	Executes a SHORT reflection calibration on test port x by using the frequency that is set in test port x. The x changes by the selected test port and calibration method.	:SENS{1-16}:CORR:OFFS:COLL:SHOR
Port x @ Freq y [Short]	Executes a SHORT reflection calibration on test port x by using the frequency that is set in test port y. The x and y change by the selected test port and calibration method.	:SENS{1-16}:CORR:OFFS:COLL:SHOR
Port x @ Freq x [Broadband]	Executes a LOAD reflection calibration on test port x by using the frequency that is set in test port x. The x changes by the selected test port and calibration method.	:SENS{1-16}:CORR:OFFS:COLL:LOAD
Port x @ Freq y [Broadband]	Executes a LOAD reflection calibration on test port x by using the frequency that is set in test port y. The x and y change by the selected test port and calibration method.	:SENS{1-16}:CORR:OFFS:COLL:LOAD
:	:	:
Return	Returns to the softkey display in one level higher.	

Softkey Functions Calibration Menu







Key Operation	Function	SCPI Command
Cal	(Continued)	
Mixer/Converter Calibration		
Scalar Cal (Manual)		
Transmission	Displays the softkey to execute THRU standard measurements.	
Thru x-y @ Freq x [Thru]	Executes a THRU calibration on test ports x and y by using the frequency that is set in test port x. The x and y change by the selected test port and calibration method.	:SENS{1-16}:CORR:OFFS:COLL:THRU
Thru y-x @ Freq y [Thru]	Executes a THRU calibration on test ports y and x by using the frequency that is set in test port y. The x and y change by the selected test port and calibration method.	:SENS{1-16}:CORR:OFFS:COLL:THRU
Return	Returns to the softkey display in one level higher.	
Power Meter	Displays the softkey to execute a power calibration.	
Use Sensor	Selects the channel of the power sensor you want to use for the measurement of power calibration data.	:SENS{1-16}:CORR:OFFS:COLL:PMET
Port x @ Freq x	Executes a power calibration on test port x by using the frequency that is set in test port x. The x changes by the selected test port and calibration method.	:SENS{1-16}:CORR:OFFS:COLL:PMET
Port x @ Freq y	Executes a power calibration on test port x by using the frequency that is set in test port y. The x and y change by the selected test port and calibration method.	:SENS{1-16}:CORR:OFFS:COLL:PMET
Port y @ Freq x	Executes a power calibration on test port y by using the frequency that is set in test port x. The x and y change by the selected test port and calibration method.	:SENS{1-16}:CORR:OFFS:COLL:PMET
Port y @ Freq y	Executes a power calibration on test port y by using the frequency that is set in test port y. The y changes by the selected test port and calibration method.	:SENS{1-16}:CORR:OFFS:COLL:PMET
Return	Returns to the softkey display in one level higher.	
Done	Terminates a calibration process and calculates the calibration coefficients.	:SENS{1-16}:CORR:OFFS:COLL:SAVE
Cancel	Displays the softkey to cancel a calibration.	
OK	Cancels a calibration process and clear the measurement data of standard.	:SENS{1-16}:CORR:OFFS:COLL:CLE
Cancel	Returns to the softkey display in one level higher.	
Return	Returns to the softkey display in one level higher.	
Scalar Cal (ECal)	Displays the softkey to execute a scalar-mixer calibration by using the ECal.	
Select Ports	Displays the softkey to select test ports and calibration methods you want to use for scalar-mixer calibration.	
Port 1	Select 1-port calibration for the test port 1.	None
:	:	:
Port 4*2	Select 1-port calibration for the test port 4.	None
2-1 (fwd)	Select a scalar-mixer calibration for test port 1→2 (forward).	None
1-2 (rev)	Select a scalar-mixer calibration for test port 2→1 (reverse).	None
2,1 (both)	Select a scalar-mixer calibration for test port 1→2 and 2→1 (both directions).	None
:	:	:
4-3 (fwd)*2	Select a scalar-mixer calibration for test port 3→4 (forward).	None
3-4 (rev)*2	Select a scalar-mixer calibration for test port 4→3 (reverse).	None

Key Operation	Function	SCPI Command
Cal	(Continued)	
Mixer/Converter Calibration		
Scalar Cal (ECal)		
Select Ports		
3,4 (both)*2	Select a scalar-mixer calibration for test port 3→4 and 4→3 (both directions).	None
Cancel	Returns to the softkey display in one level higher.	
Power Meter	Displays the softkey to execute a power calibration.	
Use Sensor	Selects the channel of the power sensor you want to use for the measurement of power calibration data.	:SENS{1-16}:CORR:OFFS:COLL:PMET
Port x @ Freq x	Executes a power calibration on test port x by using the frequency that is set in test port x. The x changes by the selected test port and calibration method.	:SENS{1-16}:CORR:OFFS:COLL:PMET
Port x @ Freq y	Executes a power calibration on test port x by using the frequency that is set in test port y. The x and y change by the selected test port and calibration method.	:SENS{1-16}:CORR:OFFS:COLL:PMET
Port y @ Freq x	Executes a power calibration on test port y by using the frequency that is set in test port x. The x and y change by the selected test port and calibration method.	:SENS{1-16}:CORR:OFFS:COLL:PMET
Port y @ Freq y	Executes a power calibration on test port y by using the frequency that is set in test port y. The y changes by the selected test port and calibration method.	:SENS{1-16}:CORR:OFFS:COLL:PMET
Return	Returns to the softkey display one level higher.	
ECal & Done	Executes a scalar-mixer calibration and calculates the calibration coefficient. The GPIB command and parameter change by the selected test port and calibration method.	:SENS{1-16}:CORR:OFFS:COLL:SMIX2 :SENS{1-16}:CORR:OFFS:COLL:SOLT1
Cancel	Displays the softkey to cancel a calibration.	
OK	Cancels a calibration process and clear the measurement data of standard.	:SENS{1-16}:CORR:OFFS:COLL:CLE
Cancel	Returns to the softkey display one level higher.	
Return	Returns to the softkey display one level higher.	
Clear	Displays the softkey that clears the scalar-mixer calibration coefficient.	
OK	Clears the scalar-mixer calibration coefficient.	:SENS{1-16}:CORR:OFFS:CLE
Cancel	Returns to the softkey display screen one level higher.	
Return	Returns to the softkey display screen one level higher.	
Cal Trig Source	Displays the softkey to set the trigger source for calibration.	
Internal	Sets the trigger source at calibration to "Internal".	:SENS{1-16}:CORR:TRIG:SOUR:FREE ON
System	Sets the trigger source at calibration to the same trigger source setting used when measurement is made.	:SENS{1-16}:CORR:TRIG:SOUR:FREE OFF
Return	Returns to the "E5070B/E5071B Menu (Top Menu)" on page 646.	

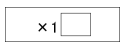
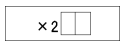
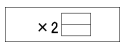
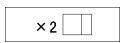
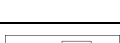
*1. Only with Options 313, 314, 413, and 414.

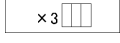
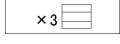
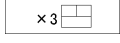
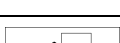
*2. Only with Options 413 and 414.

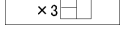
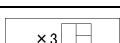
Display Menu

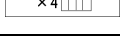
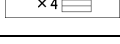
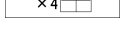
Key Operation	Function	SCPI Command
Display	Displays softkeys for setting up display options.	
Allocate Channels	Displays softkeys for setting the number of channels to be displayed and the channel window arrangement. The execution of measurements does not depend on the display status of each channel (measurements can be performed on channels that are not displayed). The user can set up each channel for measurements (by selecting the sweep mode and the trigger source) from the “Trigger Menu” on page 725.	
	Displays channel 1 using the entire display screen.	:DISP:SPL D1
	Displays channel windows by bisecting the screen horizontally with channel 1 on the left and channel 2 on the right.	:DISP:SPL D12
	Displays channel windows by bisecting the screen vertically, with channel 1 displayed above channel 2.	:DISP:SPL D1_2
	Displays channel windows by splitting the screen vertically (with the left window occupying 2/3 of the screen), with channel 1 on the left and channel 2 on the right.	:DISP:SPL D112
	Displays channel windows by splitting the screen vertically (with the upper window occupying 2/3 of the screen), and channel 1 displayed above channel 2.	:DISP:SPL D1_1_2
	Displays channel windows by trisecting the screen horizontally, with channels 1, 2, and 3 displayed from left to right.	:DISP:SPL D123
	Displays channel windows by trisecting the screen vertically with channels 1, 2, and 3 arranged from top to bottom.	:DISP:SPL D1_2_3
	Displays channel windows by bisecting the screen vertically and then bisecting the upper window horizontally with channels 1, 2, and 3 displayed, respectively, in the upper-left corner, upper-right corner, and bottom.	:DISP:SPL D12_33
	Displays channel windows by bisecting the screen vertically and then bisecting the lower window horizontally with channels 1, 2, and 3 displayed, respectively, in the top, lower-left corner, and lower-right corner.	:DISP:SPL D11_23
	Displays channel windows by bisecting the screen horizontally and then bisecting the left window vertically, with channels 1, 2, and 3 displayed, respectively, in the upper-left corner, lower-left corner, and on the right.	:DISP:SPL D13_23
	Displays channel windows by bisecting the screen horizontally and then bisecting the right window vertically, with channels 1, 2, and 3 displayed, respectively, on the left, in the upper-right corner, and lower-right corner.	:DISP:SPL D12_13
	Displays channel windows by splitting the screen horizontally into four equal parts, with channels 1, 2, 3, and 4 displayed from left to right.	:DISP:SPL D1234
	Displays channel windows by splitting the screen vertically into four equal parts, with channels 1, 2, 3, and 4 displayed from top to bottom.	:DISP:SPL D1_2_3_4
	Displays channel windows by bisecting the screen both vertically and horizontally with channels 1, 2, 3, and 4 in the upper-left, upper-right, lower-left corner, and lower-right corners, respectively.	:DISP:SPL D12_34
	Displays channel windows by trisecting the screen horizontally and then bisecting each window vertically, with channels 1, 2, 3, 4, 5, and 6 displayed.	:DISP:SPL D123_456
	Displays channel windows by bisecting the screen horizontally and trisecting each window vertically, with channels 1, 2, 3, 4, 5, and 6 displayed.	:DISP:SPL D12_34_56
	Displays channel windows by splitting the screen horizontally into four equal parts and then bisecting each window vertically, with channels 1, 2, 3, and 4 displayed in upper windows from left to right, and channels 5, 6, 7, and 8 displayed in lower windows from left to right.	:DISP:SPL D1234_5678

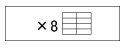
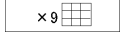
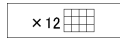
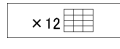
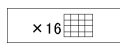
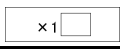
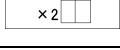
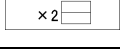
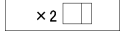
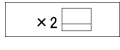
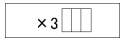
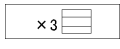
Key Operation	Function	SCPI Command
Display	(Continued)	
Allocate Channels		
 × 8	Displays channel windows by splitting the screen vertically into four equal parts and then bisecting each window horizontally, with channels 1, 3, 5, and 7 displayed in left windows from top to bottom, and channels 2, 4, 6, and 8 displayed in right windows from top to bottom.	:DISP:SPL D12_34_56_78
 × 9	Displays channels 1, 2, and 3 from the left of the upper part, channels 4,5, and 6 from the left of the middle part, and channels 7, 8, and 9 from the left of the lower part in the display area divided into 9 as softkey labels.	:DISP:SPL D123_456_789
 × 12	Displays channels 1, 2, 3, and 4 from the left of the upper part, channels 5, 6, 7, and 8 from the left of the middle part, and channels 9, 10, 11, and 12 from the left of the lower part in the display area divided into 12 as softkey labels.	:DISP:SPL D1234_9ABC
 × 12	Displays channels 1, 2, and 3 from the left of the 1st line, channels 4, 5, and 6 from the left of the 2nd line, channels 7, 8, and 9 from the left of the 3rd line, and channels 10, 11, and 12 from the left of the 4th line in the display area divided into 12 as softkey labels.	:DISP:SPL D123__ABC
 × 16	Displays channels 1, 2, 3, and 4 from the left of the 1st line, channels 5, 6, 7, and 8 from the left of the 2nd line, channels 9, 10, 11, and 12 from the left of the 3rd line, and channels 13, 14, 15, and 16 from the left of the 4th line in the display area divided into 16 as softkey labels.	:DISP:SPL D1234_CDEF
Cancel	Returns to the softkey display screen one level higher.	
Number of Traces	Displays softkeys for setting the number of traces.	
1	Sets the number of traces to one for the active channel.	:CALC{1-16}:PAR:COUN 1
2	Sets the number of traces to two for the active channel.	:CALC{1-16}:PAR:COUN 2
3	Sets the number of traces to three for the active channel.	:CALC{1-16}:PAR:COUN 3
4	Sets the number of traces to four for the active channel.	:CALC{1-16}:PAR:COUN 4
5	Sets the number of traces to five for the active channel.	:CALC{1-16}:PAR:COUN 5
6	Sets the number of traces to six for the active channel.	:CALC{1-16}:PAR:COUN 6
7	Sets the number of traces to seven for the active channel.	:CALC{1-16}:PAR:COUN 7
8	Sets the number of traces to eight for the active channel.	:CALC{1-16}:PAR:COUN 8
9	Sets the number of traces to nine for the active channel.	:CALC{1-16}:PAR:COUN 9
Cancel	Returns to the softkey display screen one level higher.	
Allocate Traces	Displays softkeys for setting up the trace display arrangement. Traces are displayed based on the order determined from the graph arrangement currently being used. If the number of traces is less than the number of graphs, nothing will be displayed in the extra area(s). If the number of traces is more than the number of graphs, the remaining traces will be displayed by going back to the first graph, overlapping existing traces.	
 × 1	Displays channel 1 using the entire channel window.	:DISP:WIND{1-16}:SPL D1
 × 2	Displays graphs by bisecting the screen horizontally with graph 1 on the left and graph 2 on the right.	:DISP:WIND{1-16}:SPL D1_2
 × 2	Displays graphs by bisecting the screen vertically, with graph 1 displayed above graph 2.	:DISP:WIND{1-16}:SPL D12
 × 2	Displays graphs by splitting the screen vertically (with the left window occupying 2/3 of the screen), with graph 1 on the left and graph 2 on the right.	:DISP:WIND{1-16}:SPL D112
 × 2	Displays graphs by splitting the screen vertically (with the upper window occupying 2/3 of the screen), and graph 1 displayed above graph 2.	:DISP:WIND{1-16}:SPL D1_1_2
 × 3	Displays graphs by trisecting the screen horizontally, with graphs 1, 2, and 3 displayed from left to right.	:DISP:WIND{1-16}:SPL D123
 × 3	Displays graphs by trisecting the screen vertically with graphs 1, 2, and 3 arranged from top to bottom.	:DISP:WIND{1-16}:SPL D1_2_3

Softkey Functions Display Menu

Key Operation	Function	SCPI Command
Display	(Continued)	
Allocate Traces		
× 3	Displays graphs by bisecting the screen vertically and then bisecting the upper window horizontally with graphs 1, 2, and 3 displayed, respectively, in the upper-left corner, upper-right corner, and bottom.	:DISP:WIND{1-16}:SPL D12_33
× 3	Displays graphs by bisecting the screen vertically and then bisecting the lower window horizontally with graphs 1, 2, and 3 displayed, respectively, in the top, lower-left corner, and lower-right corner.	:DISP:WIND{1-16}:SPL D11_23
× 3	Displays graphs by bisecting the screen horizontally and then bisecting the left window vertically, with graphs 1, 2, and 3 displayed, respectively, in the upper-left corner, lower-left corner, and on the right.	:DISP:WIND{1-16}:SPL D13_23
× 3	Displays graphs by bisecting the screen horizontally and then bisecting the right window vertically, with graphs 1, 2, and 3 displayed, respectively, on the left, in the upper-right corner, and lower-right corner.	:DISP:WIND{1-16}:SPL D12_13
× 4	Displays graphs by splitting the screen horizontally into four equal parts, with graphs 1, 2, 3, and 4 displayed from left to right.	:DISP:WIND{1-16}:SPL D1234
× 4	Displays graphs by splitting the screen vertically into four equal parts, with graphs 1, 2, 3, and 4 displayed from top to bottom.	:DISP:WIND{1-16}:SPL D1_2_3_4
× 4	Displays graphs by bisecting the screen both vertically and horizontally with graphs 1, 2, 3, and 4 in the upper-left, upper-right, lower-left corner, and lower-right corners, respectively.	:DISP:WIND{1-16}:SPL D12_34
× 6	Displays graphs by trisecting the screen horizontally and then bisecting each window vertically, with graphs 1, 2, 3, 4, 5, and 6 displayed.	:DISP:WIND{1-16}:SPL D123_456
× 6	Displays graphs by bisecting the screen horizontally and trisecting each window vertically, with graphs 1, 2, 3, 4, 5, and 6 displayed.	:DISP:WIND{1-16}:SPL D12_34_56
× 8	Displays graphs by splitting the screen horizontally into four equal parts and then bisecting each window vertically, with graphs 1, 2, 3, and 4 displayed in upper windows from left to right, and graphs 5, 6, 7, and 8 displayed in lower windows from left to right.	:DISP:WIND{1-16}:SPL D1234_5678
× 8	Displays graphs by splitting the screen vertically into four equal parts and then bisecting each window horizontally, with graphs 1, 3, 5, and 7 displayed in left windows from top to bottom, and graphs 2, 4, 6, and 8 displayed in right windows from top to bottom.	:DISP:WIND{1-16}:SPL D12_34_56_78
× 9	Displays graphs 1, 2, and 3 from the left of the upper part, graphs 4,5, and 6 from the left of the middle part, and graphs 7,8, and 9 from the left of the lower part in the display area divided into 9 as softkey labels	:DISP:WIND{1-16}:SPL D123_456_789
× 12	Displays graphs 1, 2, 3, and 4 from the left of the upper part, graphs 5, 6, 7, and 8 from the left of the middle part, and graphs 9, 10, 11, and 12 from the left of the lower part in the display area divided into 12 as softkey labels.	:DISP:WIND{1-16}:SPL D1234__9ABC
× 12	Displays graphs 1, 2, and 3 from the left of the 1st line, graphs 4, 5, and 6 from the left of the 2nd line, graphs 7, 8, and 9 from the left of the 3rd line, and graphs 10, 11, and 12 from the left of the 4th line in the display area divided into 12 as softkey labels.	:DISP:WIND{1-16}:SPL D123__ABC
× 16	Displays graphs 1, 2, 3, and 4 from the left of the 1st line, graphs 5, 6, 7, and 8 from the left of the 2nd line, graphs 9, 10, 11, and 12 from the left of the 3rd line, and graphs 13, 14, 15, and 16 from the left of the 4th line in the display area divided into 16 as softkey labels.	:DISP:WIND{1-16}:SPL D1234_CDEF
Return	Returns to the softkey display screen one level higher.	
Display	Displays softkeys for selecting between data trace and memory trace for on-screen display.	
Data	Selects data trace for on-screen display. If the data math option was enabled in the Data Math menu, the computation results will also be displayed.	:DISP:WIND{1-16}:TRAC{1-16}:STAT
Mem	Selects memory trace for on-screen display. To store data for a memory trace, go back to the previous menu and press Data \oplus Mem .	:DISP:WIND{1-16}:TRAC{1-16}:MEM

Key Operation	Function	SCPI Command
Display	(Continued)	
Display		
Data & Mem	Selects both data trace and memory trace for on-screen display. By storing data obtained under certain conditions, it is possible to compare them to new measurement results (data trace) obtained under different conditions. To store data for a memory trace, go back to the previous menu and press Data & Mem .	:DISP:WIND{1-16}:TRAC{1-16}:MEM :DISP:WIND{1-16}:TRAC{1-16}:STAT
OFF	Turns off both the data trace and memory trace.	:DISP:WIND{1-16}:TRAC{1-16}:MEM :DISP:WIND{1-16}:TRAC{1-16}:STAT
Cancel	Returns to the softkey display screen one level higher.	
Data → Mem	Stores the measured data for the current active trace in memory. Stored data can be displayed using the memory trace option. To enable/disable the memory trace, go to the Display menu.	:CALC{1-16}:MATH:MEM
Data Math	Displays softkeys for selecting the types of data processing to be performed.	
OFF	Disables the data processing function. Raw measurement data will be stored as a data trace.	:CALC{1-16}:MATH:FUNC NORM
Data / Mem	Divides the measured data by the memory trace data (normalization) and stores the results as a data trace. This function is used to evaluate the ratio between two traces (e.g., to evaluate gains and attenuations).	:CALC{1-16}:MATH:FUNC DIV
Data * Mem	Multiplies the measured data by the memory trace data and stores the result as a data trace.	:CALC{1-16}:MATH:FUNC MULT
Data - Mem	Subtracts the memory trace data from the measured data (vector operation) and stores the results as a data trace. This function is useful in determining vector errors (e.g., directivity) and storing them for data compensation for future measurements.	:CALC{1-16}:MATH:FUNC SUBT
Data + Mem	Adds the measured data to the memory trace data and stores the result as a data trace.	:CALC{1-16}:MATH:FUNC ADD
Cancel	Returns to the softkey display screen one level higher.	
Equation Editor...	Opens the equation editor dialog to enter an equation or equation label.	:CALC{1-16}:EQU:TEXT
Equation	Turns on/off the equation editor. When the equation editor is ON, trace data are calculated based on the equation specified using the equation editor.	:CALC{1-16}:EQU:STAT
Edit Title Label	Displays the input bar for editing title labels. Each channel is allowed to have a title label up to 100 characters in length. However, the entire title bar may not be displayed depending on the width of the channel window.	:DISP:WIND{1-16}:TITL:DATA
Title Label	Enables or disables the title label display. Once a title label is assigned, it can be displayed within the title bar at the top of a channel window by enabling the title label display. Title labels are useful for adding extra information to saved data and printouts.	:DISP:WIND{1-16}:TITL
Graticule Label	Enables or disables the graticule label display for the Y-axis in a rectangular display format. Disabling the graticule label display will result in expanded graph areas.	:DISP:WIND{1-16}:LAB
Invert Color	Inverts the display colors for all channel windows. Inverting colors from the normal display will create white backgrounds.	:DISP:IMAG
Frequency	Enables or disables the frequency display on the screen. This function is useful for protecting critical information by making it impossible to obtain frequencies used in measurements just by glancing at the screen.	:DISP:ANN:FREQ:STAT
Update	Enables or disables screen updates. When disabled, the analyzer can save time required for screen updates and thus improve measurement throughput. If it is not necessary to confirm results on the screen, this is an effective way to improve throughput.	:DISP:ENAB
Return	Returns to the “E5070B/E5071B Menu (Top Menu)” on page 646.	

Format Menu

Key Operation	Function	SCPI Command
Format	Displays softkeys for setting up data formats.	
Log Mag	Displays traces in a rectangular display format with log magnitude (dB) on the Y-axis and frequencies on the X-axis (log magnitude format).	:CALC{1-16}:SEL:FORM MLOG
Phase	Displays traces in a rectangular display format with phase (-180° to +180°) on the Y-axis and frequencies on the X-axis (phase format).	:CALC{1-16}:SEL:FORM PHAS
Group Delay	Displays traces in a rectangular display format with group delay (s) on the Y-axis and frequencies on the X-axis (group delay format).	:CALC{1-16}:SEL:FORM GDEL
Smith	Displays softkeys for setting up smith chart.	
Lin / Phase	Displays traces in Smith chart format. The marker response values are linear magnitude and phase (°).	:CALC{1-16}:SEL:FORM SLIN
Log / Phase	Displays traces in Smith chart format. The marker response values are log magnitude (dB) and phase (°).	:CALC{1-16}:SEL:FORM SLOG
Real / Imag	Displays traces in Smith chart format. The marker response values are the real and imaginary parts.	:CALC{1-16}:SEL:FORM SCOM
R + jX	Displays traces in Smith chart format. The marker response values are resistance (W) and reactance (W).	:CALC{1-16}:SEL:FORM SMIT
G + jB	Displays traces in Smith chart format. The marker response values are conductance (S) and susceptance (S).	:CALC{1-16}:SEL:FORM SMGB
Cancel	Returns to the softkey display screen one level higher.	
Ploar	Displays softkeys for setting up polar format.	
Lin / Phase	Displays traces in polar format. The marker response values are linear magnitude and phase (°).	:CALC{1-16}:SEL:FORM PLIN
Log / Phase	Displays traces in polar format. The marker response values are log magnitude (dB) and phase (°).	:CALC{1-16}:SEL:FORM PLOG
Real / Imag	Displays traces in polar format. The marker response values are the real and imaginary parts.	:CALC{1-16}:SEL:FORM POL
Cancel	Returns to the softkey display screen one level higher.	
Lin Mag	Displays traces in a rectangular display format with linear magnitude on the Y-axis and frequencies on the X-axis (linear magnitude format).	:CALC{1-16}:SEL:FORM MLIN
SWR	Displays traces in a rectangular display format with SWR (standing wave ratio) on the Y-axis and frequencies on the X-axis (SWR format).	:CALC{1-16}:SEL:FORM SWR
Real	Displays traces in a rectangular display format with the real part on the Y-axis and frequencies on the X-axis (real format).	:CALC{1-16}:SEL:FORM REAL
Imaginary	Displays traces in a rectangular display format with the imaginary part on the Y-axis and frequencies on the X-axis (imaginary format).	:CALC{1-16}:SEL:FORM IMAG
Expand Phase	Displays traces in a rectangular display format with expanded phase (°) on the Y-axis and frequencies on the X-axis (expanded phase format).	:CALC{1-16}:SEL:FORM UPH
Positive Phase	Displays traces in a rectangular display format with phase (0° to +360°) on the Y-axis and frequencies on the X-axis (positive phase format).	:CALC{1-16}:SEL:FORM PPH
Return	Returns to the “E5070B/E5071B Menu (Top Menu)” on page 646.	

Macro Setup Menu

Key Operation	Function	SCPI Command
Macro Setup	Displays the macro setup menu.	
VBA Editor	Starts the VBA editor. A keyboard and mouse are necessary to use this editor.	None
New Project	Creates a new VBA project.	None
Load Project	Opens a dialog box for loading a saved VBA project.	:MMEM:LOAD:PROG
Load & Run	Displays programs (VBA projects) stored under D:\VBA as a list of softkeys.	
(program name)	Loads the program whose name is shown in the softkey label and executes it.	None
:	:	
(program name)	Loads the program whose name is shown in the softkey label and executes it.	
Return	Returns to the softkey display screen one level higher.	
Save Project	Opens a dialog box for saving a VBA project.	:MMEM:STOR:PROG
Close Editor	Closes the currently open VBA editor.	None
Select Macro	Displays a list of all macros in the form of softkeys from which they can be executed.	
(macro name)	Executes the macro that corresponds to the softkey.	:PROG:NAME
:	:	:PROG:STAT
(macro name)	Executes the macro that corresponds to the softkey.	
Cancel	Returns to the softkey display screen one level higher.	
Stop	Stops execution of a program after executing the line of code being executed at the time the Stop key is pressed.	:PROG:STAT
Continue	Resumes execution of a program that has been stopped.	:PROG:STAT
Echo Window	Enables or disables the echo window display at the bottom of the screen.	:DISP:TABL :DISP:TABL:TYPE
Clear Echo	Clears text displayed in the echo window.	:DISP:ECHO:CLE
User Menu	Displays user menu softkeys.	
Button 1	Executes the procedure assigned to Button 1 . Softkey label can be modified using a command.	None
Button 2	Executes the procedure assigned to Button 2 . Softkey label can be modified using a command.	None
Button 3	Executes the procedure assigned to Button 3 . Softkey label can be modified using a command.	None
Button 4	Executes the procedure assigned to Button 4 . Softkey label can be modified using a command.	None
Button 5	Executes the procedure assigned to Button 5 . Softkey label can be modified using a command.	None
Button 6	Executes the procedure assigned to Button 6 . Softkey label can be modified using a command.	None
Button 7	Executes the procedure assigned to Button 7 . Softkey label can be modified using a command.	None
Button 8	Executes the procedure assigned to Button 8 . Softkey label can be modified using a command.	None
Button 9	Executes the procedure assigned to Button 9 . Softkey label can be modified using a command.	None

Softkey Functions
Macro Setup Menu

Key Operation	Function	SCPI Command
Macro Setup	(Continued)	
User Menu		
Button 10	Executes the procedure assigned to Button 10 . Softkey label can be modified using a command.	None
Return	Returns to the softkey display screen one level higher.	
Preset User Menu	Returns the softkey labels of user menu to the initial settings.	None
Return	Returns to the “E5070B/E5071B Menu (Top Menu)” on page 646.	

Marker Menu

Key Operation	Function	SCPI Command
Marker	Activates marker 1 and displays an input dialog box for setting the stimulus value for marker 1. Also displays softkeys for setting and moving each marker.	
Marker 1	Enables marker 1 if it is disabled. Also activates marker 1 and displays an input dialog box for setting the stimulus value.	:CALC{1-16}:MARK1 :CALC{1-16}:MARK1:ACT :CALC{1-16}:MARK1:X
Marker 2	Enables marker 2 if it is disabled. Also activates marker 2 and displays an input dialog box for setting the stimulus value.	:CALC{1-16}:MARK2 :CALC{1-16}:MARK2:ACT :CALC{1-16}:MARK2:X
Marker 3	Enables marker 3 if it is disabled. Also activates marker 3 and displays an input dialog box for setting the stimulus value.	:CALC{1-16}:MARK3 :CALC{1-16}:MARK3:ACT :CALC{1-16}:MARK3:X
Marker 4	Enables marker 4 if it is disabled. Also activates marker 4 and displays an input dialog box for setting the stimulus value.	:CALC{1-16}:MARK4 :CALC{1-16}:MARK4:ACT :CALC{1-16}:MARK4:X
More Markers	Displays softkeys for setting markers 5 to 9.	
Marker 5	Enables marker 5 if it is disabled. Also activates marker 5 and displays an input dialog box for setting the stimulus value.	:CALC{1-16}:MARK5 :CALC{1-16}:MARK5:ACT :CALC{1-16}:MARK5:X
Marker 6	Enables marker 6 if it is disabled. Also activates marker 6 and displays an input dialog box for setting the stimulus value.	:CALC{1-16}:MARK6 :CALC{1-16}:MARK6:ACT :CALC{1-16}:MARK6:X
Marker 7	Enables marker 7 if it is disabled. Also activates marker 7 and displays an input dialog box for setting the stimulus value.	:CALC{1-16}:MARK7 :CALC{1-16}:MARK7:ACT :CALC{1-16}:MARK7:X
Marker 8	Enables marker 8 if it is disabled. Also activates marker 8 and displays an input dialog box for setting the stimulus value.	:CALC{1-16}:MARK8 :CALC{1-16}:MARK8:ACT :CALC{1-16}:MARK8:X
Marker 9	Enables marker 9 if it is disabled. Also activates marker 9 and displays an input dialog box for setting the stimulus value.	:CALC{1-16}:MARK9 :CALC{1-16}:MARK9:ACT :CALC{1-16}:MARK9:X
Return	Returns to the softkey display screen one level higher.	
Ref Marker	Enables the reference marker if it is disabled (the reference marker mode [Ref Marker Mode] is enabled at the same time). Also activates the reference marker and displays an input dialog box for setting the stimulus value.	:CALC{1-16}:MARK10 :CALC{1-16}:MARK10:ACT :CALC{1-16}:MARK10:X
Clear Marker Menu	Displays softkeys for turning off each marker.	
All OFF	Turns off all markers on the active trace.	None
Marker 1	Turns off marker 1 on the active trace.	:CALC{1-16}:MARK1
Marker 2	Turns off marker 2 on the active trace.	:CALC{1-16}:MARK2
Marker 3	Turns off marker 3 on the active trace.	:CALC{1-16}:MARK3
Marker 4	Turns off marker 4 on the active trace.	:CALC{1-16}:MARK4
Marker 5	Turns off marker 5 on the active trace.	:CALC{1-16}:MARK5
Marker 6	Turns off marker 6 on the active trace.	:CALC{1-16}:MARK6
Marker 7	Turns off marker 7 on the active trace.	:CALC{1-16}:MARK7
Marker 8	Turns off marker 8 on the active trace.	:CALC{1-16}:MARK8
Marker 9	Turns off marker 9 on the active trace.	:CALC{1-16}:MARK9
Ref Marker	Turns off the reference marker on the active trace.	:CALC{1-16}:MARK10
Return	Returns to the softkey display screen one level higher.	
Marker Æ Ref Marker	Replaces the stimulus value of the reference marker with that of the active marker. As a result, the reference marker will be placed at the same position as the active marker.	None

Softkey Functions
Marker Menu

Key Operation	Function	SCPI Command
Marker	(Continued)	
Ref Marker Mode	Enables or disables the reference marker mode. When enabled, stimulus values and response values of markers 1 to 9 will be displayed using values relative to the reference marker. When disabled, the reference marker will not appear on the screen.	:CALC{1-16}:MARK{1-10}:REF
Return	Returns to the “E5070B/E5071B Menu (Top Menu)” on page 646.	

Marker Function Menu

Key Operation	Function	SCPI Command
Marker Fctn	Displays softkeys for setting the sweep range using markers and other marker options.	
Marker → Start	Sets the starting frequency to the stimulus value of the active marker on the active trace. Even if the reference marker is enabled and a relative stimulus value is displayed, the absolute value will be used.	:CALC{1-16}:MARK{1-10}:SET STAR
Marker → Stop	Sets the ending frequency to the stimulus value of the active marker on the active trace. Even if the reference marker is enabled and a relative stimulus value is displayed, the absolute value will be used.	:CALC{1-16}:MARK{1-10}:SET STOP
Marker → Center	Sets the center frequency to the stimulus value of the active marker on the active trace. Even if the reference marker is enabled and a relative stimulus value is displayed, the absolute value will be used.	:CALC{1-16}:MARK{1-10}:SET CENT
Marker → Reference	Sets the value of the reference line to the response value of the active marker on the active trace. A softkey having the same function is also provided in “Scale Menu” on page 713.	:CALC{1-16}:MARK{1-10}:SET RLEV
Marker → Delay	Sets the electrical delay to the value of the group delay at the position of the active marker (a value smoothed with the aperture of 20% regardless of the setting of smoothing).	:CALC{1-16}:MARK{1-10}:SET DEL
Discrete	Enables or disables the discrete marker function. When enabled, the marker will be placed at the nearest measurement point from the specified marker stimulus value. When disabled, the marker will be placed at the point corresponding to the specified marker stimulus value (by interpolating gaps between measurement points).	:CALC{1-16}:MARK{1-10}:DISC
Couple	Enables or disables marker coupling. When enabled, marker settings and movements become effective for all traces on a channel. When disabled, marker settings and movements are done independently on each trace.	:CALC{1-16}:MARK{1-10}:COUP
Marker Table	Enables or disables the marker table display. The marker table lists the values of markers for all traces defined on a channel using the bottom third of the screen. If a channel holds too many markers to be displayed in the display area, use the scroll bar on the right to view the entire table.	:DISP:TABL :DISP:TABL:TYPE MARK
Statistics	Enables or disables the display of statistics. When enabled, the following three statistical data items (Mean value, Standard deviation, Peak-to-peak) will be displayed on the screen. For details, see “Determining the Mean, Standard Deviation, and p-p of the Trace” on page 272.	:CALC{1-16}:MST
Annotation Options	Displays softkeys for the appearance of the marker values displayed on the screen.	
Marker Info X Pos	Specifies the horizontal display position by the width of the display area as a percentage.	:DISP{1-16}:WIND:TRAC{1-16}:ANN:MARK:POS:X
Marker Info Y Pos	Specifies vertical display position by the height of the display area as a percentage.	:DISP{1-16}:WIND:TRAC{1-16}:ANN:MARK:POS:Y
Align	Enables or disables the mode to align the display position of the marker value for each trace to trace 1.	:DISP:WIND{1-16}:ANN:MARK:ALIG
Active Only	Toggles on/off the display of marker values for active traces only.	:DISP:WIND{1-16}:ANN:MARK:SING
Return	Returns to the “E5070B/E5071B Menu (Top Menu)” on page 646.	

Marker Search Menu

Key Operation	Function	SCPI Command
Marker Search	Displays softkeys for performing searches using markers.	
Max	Moves the active marker to a position on the trace that represents the maximum response value.	:CALC{1-16}:MARK{1-10}:FUNC:EXEC :CALC{1-16}:MARK{1-10}:FUNC:TYPE MAX
Min	Moves the active marker to a position on the trace that represents the minimum response value.	:CALC{1-16}:MARK{1-10}:FUNC:EXEC :CALC{1-16}:MARK{1-10}:FUNC:TYPE MIN
Peak	Displays softkeys for setting and performing a peak search. A peak refers to a point where the response value is larger (positive peak) or smaller (negative peak) than those of adjacent measurement points on either side in a rectangular display format. A peak search picks up points that satisfy definitions given by Peak Excursion and Peak Polarity among all the peaks. If the Smith chart format or polar format is used, the main response value, among the two response values, will be used to perform searches (e.g., resistance in the Smith (R+jX) format).	
Search Peak	In the rectangular display format, the active marker will move to the peak with maximum response value among the peaks that match the definition if the peak polarity is Positive or Both , or to the peak with minimum response value if the peak polarity is Negative . The search is performed based on conditions defined by Peak Excursion and Peak Polarity .	:CALC{1-16}:MARK{1-10}:FUNC:EXEC :CALC{1-16}:MARK{1-10}:FUNC:TYPE PEAK
Search Left	In a rectangular display format, moves the active marker to the peak on its left under the given conditions. The search is performed based on conditions defined by Peak Excursion and Peak Polarity .	:CALC{1-16}:MARK{1-10}:FUNC:EXEC :CALC{1-16}:MARK{1-10}:FUNC:TYPE LPE
Search Right	In a rectangular display format, moves the active marker to the peak on its right under the given conditions. The search is performed based on conditions defined by Peak Excursion and Peak Polarity .	:CALC{1-16}:MARK{1-10}:FUNC:EXEC :CALC{1-16}:MARK{1-10}:FUNC:TYPE RPE
Peak Excursion	Sets the peak offset (and performs Search Peak at the same time). Peak offset is the difference between the response value of a peak and those of adjacent peaks of opposite polarity (the vertical interval between the tip and the base of a slope, one each on the left and right) in a rectangular display format. The smaller of the two will be used. The peak search will detect peaks with an offset larger than the set value.	:CALC{1-16}:MARK{1-10}:FUNC:PEXC
Peak Polarity	Displays softkeys for selecting the polarity of peaks. A peak search will detect peaks having the matching polarity.	
Positive	Selects positive polarity (and performs Search Peak at the same time). A positive peak is a point whose measured value is larger than the values of the two adjacent points on its left and right.	:CALC{1-16}:MARK{1-10}:FUNC:PPOL POS
Negative	Selects negative polarity (and performs Search Peak at the same time). A negative peak is a point whose measured value is smaller than the values of the two adjacent points on its left and right.	:CALC{1-16}:MARK{1-10}:FUNC:PPOL NEG
Both	Selects both positive and negative polarity (and performs Search Peak at the same time).	:CALC{1-16}:MARK{1-10}:FUNC:PPOL BOTH
Cancel	Returns to the softkey display screen one level higher.	
Return	Returns to the softkey display screen one level higher.	

Key Operation	Function	SCPI Command
Marker Search	(Continued)	
Target	Displays softkeys for setting and performing target searches. A target refers to a point on a trace that has a unique response value (target value) in a rectangular display format. A target search picks up points that have matching characteristics defined by Target Value and Target Transition . If the Smith chart format or polar format is used, the main response value, among the two response values, will be used to perform searches (e.g., resistance in the Smith (R+jX) format).	
Search Target	In a rectangular display format, moves the active marker to the nearest target (i.e., the closest stimulus value on the X-axis) that matches the definition (having a unique response value - the target value). The conditions for a target search must be defined using Target Value and Target Transition .	:CALC{1-16}:MARK{1-10}:FUNC:EXEC :CALC{1-16}:MARK{1-10}:FUNC:TYPE TARG
Search Left	In a rectangular display format, moves the active marker to the target that is nearest on its left and that matches the definition (having a unique response value - the target value). The conditions for a target search must be defined using Target Value and Target Transition .	:CALC{1-16}:MARK{1-10}:FUNC:EXEC :CALC{1-16}:MARK{1-10}:FUNC:TYPE LTAR
Search Right	In a rectangular display format, moves the active marker to the target that is nearest on its right and that matches the definition (having a unique response value - the target value). The conditions for a target search must be defined using Target Value and Target Transition .	:CALC{1-16}:MARK{1-10}:FUNC:EXEC :CALC{1-16}:MARK{1-10}:FUNC:TYPE RTAR
Target Value	Sets the target value (desired response value). (Also performs Search Target at the same time.) A target search uses the target value to look for a point on a trace.	:CALC{1-16}:MARK{1-10}:FUNC:TARG
Target Transition	Displays softkeys for defining the transition direction.	
Positive	Selects positive transition for a target search (and performs Search Target at the same time). Targets with positive transition refer to points whose response value is larger than the value of the adjacent point on its left in a rectangular display format.	:CALC{1-16}:MARK{1-10}:FUNC:TTR POS
Negative	Selects negative transition for a target search (and performs Search Target at the same time). Targets with negative transition refer to points whose response value is larger than the value of the adjacent point on its left in a rectangular display format.	:CALC{1-16}:MARK{1-10}:FUNC:TTR NEG
Both	Selects both positive and negative transition for a target search (and performs Search Target at the same time).	:CALC{1-16}:MARK{1-10}:FUNC:TTR BOTH
Cancel	Returns to the softkey display screen one level higher.	
Return	Returns to the softkey display screen one level higher.	
Tracking	Enables or disables search tracking. When enabled, the currently selected search operation will be performed each time a sweep is completed. If disabled, you can initiate a search by pressing a key for a particular search.	:CALC{1-16}:MARK{1-10}:FUNC:TRAC
Search Range	Displays softkeys for setting the search range of the maximum, minimum, peak and target search.	
Search Range	Enables or disables partial search feature.	:CALC{1-16}:MARK:FUNC:DOM
Start	Sets start value (lower limit) of the search range.	:CALC{1-16}:MARK:FUNC:DOM:STAR
Stop	Sets stop value (upper limit) of the search range.	:CALC{1-16}:MARK:FUNC:DOM:STOP
Couple	Enables or disables trace coupling within search range.	:CALC{1-16}:MARK:FUNC:DOM:COUP
Return	Returns to the softkey display screen one level higher.	

Softkey Functions
Marker Search Menu

Key Operation	Function	SCPI Command
Marker Search	(Continued)	
Bandwidth	Enables or disables bandwidth searching. When enabled, bandwidth parameters (Insertion loss, Low cutoff point, High cutoff point, Center frequency, Bandwidth and Q) will be displayed on the screen. If the Smith chart format or polar format is used, the main response value, among the two response values, will be used to perform searches (e.g., resistance in the Smith (R+jX) format). For details, see “Determining the Bandwidth of the Trace (Bandwidth Search)” on page 270.	:CALC{1-16}:MARK{1-10}:BWID
Bandwidth Value	Sets the bandwidth. The bandwidth in a bandwidth search is defined by specifying the displacement from the active marker to the cutoff point using the response value (the value assigned to the Y-axis in a rectangular display format).	:CALC{1-16}:MARK{1-10}:BWID:THR
Return	Returns to the “E5070B/E5071B Menu (Top Menu)” on page 646.	

Measurement Menu

Key Operation	Function	SCPI Command
Meas	Displays softkeys for setting measurement parameters. These softkeys will not be displayed unless either the balanced/unbalanced conversion function or the fixture simulator function is turned off (BalUn OFF or Fixture Simulator OFF) in the “Analysis Menu” on page 647 on the E5070B/E5071B.	
S11	Selects parameter S ₁₁ .	:CALC{1-16}:PAR{1-16}:DEF S11
S21	Selects parameter S ₂₁ .	:CALC{1-16}:PAR{1-16}:DEF S21
S31 ^{*1}	Selects parameter S ₃₁ .	:CALC{1-16}:PAR{1-16}:DEF S31
S41 ^{*2}	Selects parameter S ₄₁ .	:CALC{1-16}:PAR{1-16}:DEF S41
S12	Selects parameter S ₁₂ .	:CALC{1-16}:PAR{1-16}:DEF S12
S22	Selects parameter S ₂₂ .	:CALC{1-16}:PAR{1-16}:DEF S22
S32 ^{*1}	Selects parameter S ₃₂ .	:CALC{1-16}:PAR{1-16}:DEF S32
S42 ^{*2}	Selects parameter S ₄₂ .	:CALC{1-16}:PAR{1-16}:DEF S42
S13 ^{*1}	Selects parameter S ₁₃ .	:CALC{1-16}:PAR{1-16}:DEF S13
S23 ^{*1}	Selects parameter S ₂₃ .	:CALC{1-16}:PAR{1-16}:DEF S23
S33 ^{*1}	Selects parameter S ₃₃ .	:CALC{1-16}:PAR{1-16}:DEF S33
S43 ^{*2}	Selects parameter S ₄₃ .	:CALC{1-16}:PAR{1-16}:DEF S43
S14 ^{*2}	Selects parameter S ₁₄ .	:CALC{1-16}:PAR{1-16}:DEF S14
S24 ^{*2}	Selects parameter S ₂₄ .	:CALC{1-16}:PAR{1-16}:DEF S24
S34 ^{*2}	Selects parameter S ₃₄ .	:CALC{1-16}:PAR{1-16}:DEF S34
S44 ^{*2}	Selects parameter S ₄₄ .	:CALC{1-16}:PAR{1-16}:DEF S44
Absolute	Displays softkeys for setting absolute measurement parameters.	
A(1) ^{*3}	Selects parameter A(1).	:CALC{1-16}:PAR{1-16}:DEF A :CALC{1-16}:PAR{1-16}:SPOR 1
A(2) ^{*3}	Selects parameter A(2).	:CALC{1-16}:PAR{1-16}:DEF A :CALC{1-16}:PAR{1-16}:SPOR 2
A(3) ^{*1*3}	Selects parameter A(3).	:CALC{1-16}:PAR{1-16}:DEF A :CALC{1-16}:PAR{1-16}:SPOR 3
A(4) ^{*2*3}	Selects parameter A(4).	:CALC{1-16}:PAR{1-16}:DEF A :CALC{1-16}:PAR{1-16}:SPOR 4
:	:	:
D(4) ^{*2}	Selects parameter D(4).	:CALC{1-16}:PAR{1-16}:DEF D :CALC{1-16}:PAR{1-16}:SPOR 4
R1(1) ^{*3}	Selects parameter R1(1).	:CALC{1-16}:PAR{1-16}:DEF R1 :CALC{1-16}:PAR{1-16}:SPOR 1
R1(2) ^{*3}	Selects parameter R1(2).	:CALC{1-16}:PAR{1-16}:DEF R1 :CALC{1-16}:PAR{1-16}:SPOR 2
R1(3) ^{*1*3}	Selects parameter R1(3).	:CALC{1-16}:PAR{1-16}:DEF R1 :CALC{1-16}:PAR{1-16}:SPOR 3
R1(4) ^{*2*3}	Selects parameter R1(4).	:CALC{1-16}:PAR{1-16}:DEF R1 :CALC{1-16}:PAR{1-16}:SPOR 4
:	:	:
R4(4) ^{*2*3}	Selects parameter R4(4).	:CALC{1-16}:PAR{1-16}:DEF R4 :CALC{1-16}:PAR{1-16}:SPOR 4
Return	Returns to the softkey display screen one level higher.	
Return	Returns to the “E5070B/E5071B Menu (Top Menu)” on page 646.	

Softkey Functions

Measurement Menu

- *1. Only with Options 313, 314, 413, and 414.
- *2. Only with Options 413 and 414.
- *3. The numeric in parentheses indicates the stimulus port number.

Measurement Menu (Balance Measurement, SE-Bal)

Key Operation	Function	SCPI Command
Meas	Displays softkeys for setting measurement parameters (only for models with Option 313, 314, 413, or 414). To display these softkeys, the balanced/unbalanced conversion topology must be set to unbalanced-balanced (SE-Bal), the balanced/unbalanced conversion function must be on (BalUn ON), and the fixture simulator function must be on (Fixture Simulator ON) in the “Analysis Menu” on page 647.	
Sss11	Selects parameter S_{ss11} . S_{ss11} defines the way an unbalanced signal input to (unbalanced) port 1 on the DUT is reflected as an unbalanced signal.	:CALC{1-16}:FSIM:BAL:PAR{1-16}:SBAL SSS11
Sds21	Selects parameter S_{ds21} . S_{ds21} defines the way an unbalanced signal input to (unbalanced) port 1 on the DUT is transmitted to (balanced) port 2 on the DUT as a differential signal.	:CALC{1-16}:FSIM:BAL:PAR{1-16}:SBAL SDS21
Ssd12	Selects parameter S_{sd12} . S_{sd12} defines the way a differential signal input to (balanced) port 2 on the DUT is transmitted to (unbalanced) port 1 on the DUT as an unbalanced signal.	:CALC{1-16}:FSIM:BAL:PAR{1-16}:SBAL SSD12
Scs21	Selects parameter S_{cs21} . S_{cs21} defines the way an unbalanced signal input to (unbalanced) port 1 on the DUT is transmitted to (balanced) port 2 on the DUT as a common mode signal.	:CALC{1-16}:FSIM:BAL:PAR{1-16}:SBAL SCS21
Ssc12	Selects parameter S_{sc12} . S_{sc12} defines the way a common mode signal input to (balanced) port 2 on the DUT is transmitted to (unbalanced) port 1 on the DUT as an unbalanced signal.	:CALC{1-16}:FSIM:BAL:PAR{1-16}:SBAL SSC12
Sdd22	Selects parameter S_{dd22} . S_{dd22} defines the way a differential signal input to (balanced) port 2 on the DUT is reflected as a differential signal.	:CALC{1-16}:FSIM:BAL:PAR{1-16}:SBAL SDD22
Scd22	Selects parameter S_{cd22} . S_{cd22} defines the way a differential signal input to (balanced) port 2 on the DUT is reflected as a common mode signal.	:CALC{1-16}:FSIM:BAL:PAR{1-16}:SBAL SCD22
Sdc22	Selects parameter S_{dc22} . S_{dc22} defines the way a common mode signal input to (balanced) port 2 on the DUT is reflected as a differential signal.	:CALC{1-16}:FSIM:BAL:PAR{1-16}:SBAL SDC22
Scc22	Selects parameter S_{cc22} . S_{cc22} defines the way a common mode signal input to (balanced) port 2 on the DUT is reflected as a common mode signal.	:CALC{1-16}:FSIM:BAL:PAR{1-16}:SBAL SCC22
Imbalance	Selects parameter Imbalance.	:CALC{1-16}:FSIM:BAL:PAR{1-16}:SBAL IMB
Sds21/Scs21	Selects parameter Sds21/Scs21.	:CALC{1-16}:FSIM:BAL:PAR{1-16}:SBAL CMRR
Ssd12/Ssc12	Selects parameter Ssd12/Ssc12.	:CALC{1-16}:FSIM:BAL:PAR{1-16}:SBAL CMRR2
Return	Returns to the “E5070B/E5071B Menu (Top Menu)” on page 646.	

Measurement Menu (Balanced Measurement, Bal-Bal)

Key Operation	Function	SCPI Command
Meas	Displays softkeys for setting up measurement parameters (only for models with Option 412 or 414). To display these softkeys, the balanced/unbalanced conversion topology must be set to balanced-balanced (Bal-Bal), the balanced/unbalanced conversion function must be on (BalUn ON), and the fixture simulator function must be on (Fixture Simulator ON) in the “Analysis Menu” on page 647.	
Sdd11	Selects parameter S_{dd11} . S_{dd11} defines the way a differential signal input to (balanced) port 1 on the DUT is reflected as a differential signal.	:CALC{1-16}:FSIM:BAL:PAR{1-16}:BBAL SDD11
Sdd21	Selects parameter S_{dd21} . S_{dd21} defines the way a differential signal input to (balanced) port 1 on the DUT is transmitted to (balanced) port 2 on the DUT as a differential signal.	:CALC{1-16}:FSIM:BAL:PAR{1-16}:BBAL SDD21
Sdd12	Selects parameter S_{dd12} . S_{dd12} defines the way a differential signal input to (balanced) port 2 on the DUT is transmitted to (balanced) port 1 on the DUT as a differential signal.	:CALC{1-16}:FSIM:BAL:PAR{1-16}:BBAL SDD12
Sdd22	Selects parameter S_{dd22} . S_{dd22} defines the way a differential signal input to (balanced) port 2 on the DUT is reflected as a differential signal.	:CALC{1-16}:FSIM:BAL:PAR{1-16}:BBAL SDD22
Scd11	Selects parameter S_{cd11} . S_{cd11} defines the way a differential signal input to (balanced) port 1 on the DUT is reflected as a common mode signal.	:CALC{1-16}:FSIM:BAL:PAR{1-16}:BBAL SCD11
Scd21	Selects parameter S_{cd21} . S_{cd21} defines the way a differential signal input to (balanced) port 1 on the DUT is transmitted to (balanced) port 2 on the DUT as a common mode signal.	:CALC{1-16}:FSIM:BAL:PAR{1-16}:BBAL SCD21
Scd12	Selects parameter S_{cd12} . S_{cd12} defines the way a differential signal input to (balanced) port 2 on the DUT is transmitted to (balanced) port 1 on the DUT as a common mode signal.	:CALC{1-16}:FSIM:BAL:PAR{1-16}:BBAL SCD12
Scd22	Selects parameter S_{cd22} . S_{cd22} defines the way a differential signal input to (balanced) port 2 on the DUT is reflected as a common mode signal.	:CALC{1-16}:FSIM:BAL:PAR{1-16}:BBAL SCD22
Sdc11	Selects parameter S_{dc11} . S_{dc11} defines the way a common mode signal input to (balanced) port 1 on the DUT is reflected as a differential signal.	:CALC{1-16}:FSIM:BAL:PAR{1-16}:BBAL SDC11
Sdc21	Selects parameter S_{dc21} . S_{dc21} defines the way a common mode signal input to (balanced) port 1 on the DUT is transmitted to (balanced) port 2 on the DUT as a differential signal.	:CALC{1-16}:FSIM:BAL:PAR{1-16}:BBAL SDC21
Sdc12	Selects parameter S_{dc12} . S_{dc12} defines the way a common mode signal input to (balanced) port 2 on the DUT is transmitted to (balanced) port 1 on the DUT as a differential signal.	:CALC{1-16}:FSIM:BAL:PAR{1-16}:BBAL SDC12
Sdc22	Selects parameter S_{dc22} . S_{dc22} defines the way a common mode signal input to (balanced) port 2 on the DUT is reflected as a differential signal.	:CALC{1-16}:FSIM:BAL:PAR{1-16}:BBAL SDC22
Scd11	Selects parameter S_{cc11} . S_{cc11} defines the way a common mode signal input to (balanced) port 1 on the DUT is reflected as a common mode signal.	:CALC{1-16}:FSIM:BAL:PAR{1-16}:BBAL SCC11
Scd21	Selects parameter S_{cc21} . S_{cc21} defines the way a common mode signal input to (balanced) port 1 on the DUT is transmitted to (balanced) port 2 on the DUT as a common mode signal.	:CALC{1-16}:FSIM:BAL:PAR{1-16}:BBAL SCC21
Scd12	Selects parameter S_{cc12} . S_{cc12} defines the way a common mode signal input to (balanced) port 2 on the DUT is transmitted to (balanced) port 1 on the DUT as a common mode signal.	:CALC{1-16}:FSIM:BAL:PAR{1-16}:BBAL SCC12

Softkey Functions
Measurement Menu (Balanced Measurement, Bal-Bal)

Key Operation	Function	SCPI Command
Meas	(Continued)	
Scc22	Selects parameter S _{cc22} . S _{cc22} defines the way a common mode signal input to (balanced) port 2 on the DUT is reflected as a common mode signal.	:CALC{1-16}:FSIM:BAL:PAR{1-16}:BBAL SCC22
Imbalance1	Selects parameter Imbalance1.	:CALC{1-16}:FSIM:BAL:PAR{1-16}:BBAL IMB1
Imbalance2	Selects parameter Imbalance2.	:CALC{1-16}:FSIM:BAL:PAR{1-16}:BBAL IMB2
Sdd21/Scc21	Selects parameter Sdd21/Scc21.	:CALC{1-16}:FSIM:BAL:PAR{1-16}:BBAL CMRR
Return	Returns to the “E5070B/E5071B Menu (Top Menu)” on page 646.	

Measurement Menu (Balanced Measurement, SE-SE-Bal)

Key Operation	Function	SCPI Command
Meas	Displays softkeys for setting measurement parameters (only for models with Option 413 or 414). To display these softkeys, the balanced/unbalanced conversion topology must be set to unbalanced-unbalanced-balanced SE-SE-Bal , the balanced/unbalanced conversion function must be on (BalUn ON), and the fixture simulator function must be on (Fixture Simulator ON) in the “Analysis Menu” on page 647.	
Sss11	Selects parameter S_{ss11} . S_{ss11} defines the way an unbalanced signal input to (unbalanced) port 1 on the DUT is reflected as an unbalanced signal.	:CALC{1-16}:FSIM:BAL:PAR{1-16}:SSB SSS11
Sss21	Selects parameter S_{ss21} . S_{ss21} defines the way an unbalanced signal input to (unbalanced) port 1 on the DUT is transmitted to (unbalanced) port 2 on the DUT as an unbalanced signal.	:CALC{1-16}:FSIM:BAL:PAR{1-16}:SSB SSS21
Sss12	Selects parameter S_{ss12} . S_{ss12} defines the way an unbalanced signal input to (unbalanced) port 2 on the DUT is transmitted to (unbalanced) port 1 on the DUT as an unbalanced signal.	:CALC{1-16}:FSIM:BAL:PAR{1-16}:SSB SSS12
Sss22	Selects parameter S_{ss22} . S_{ss22} defines the way an unbalanced signal input to (unbalanced) port 2 on the DUT is reflected as an unbalanced signal.	:CALC{1-16}:FSIM:BAL:PAR{1-16}:SSB SSS22
Sds31	Selects parameter S_{ds31} . S_{ds31} defines the way an unbalanced signal input to (unbalanced) port 1 on the DUT is transmitted to (balanced) port 3 on the DUT as a differential signal.	:CALC{1-16}:FSIM:BAL:PAR{1-16}:SSB SDS31
Sds32	Selects parameter S_{ds32} . S_{ds32} defines the way an unbalanced signal input to (unbalanced) port 2 on the DUT is transmitted to (balanced) port 3 on the DUT as a differential signal.	:CALC{1-16}:FSIM:BAL:PAR{1-16}:SSB SDS32
Ssd13	Selects parameter S_{sd13} . S_{sd13} defines the way a differential signal input to (balanced) port 3 on the DUT is transmitted to (unbalanced) port 1 on the DUT as an unbalanced signal.	:CALC{1-16}:FSIM:BAL:PAR{1-16}:SSB SSD13
Ssd23	Selects parameter S_{sd23} . S_{sd23} defines the way a differential signal input to (balanced) port 3 on the DUT is transmitted to (unbalanced) port 2 on the DUT as an unbalanced signal.	:CALC{1-16}:FSIM:BAL:PAR{1-16}:SSB SSD23
Scs31	Selects parameter S_{cs31} . S_{cs31} defines the way an unbalanced signal input to (unbalanced) port 1 on the DUT is transmitted to (balanced) port 3 on the DUT as a common mode signal.	:CALC{1-16}:FSIM:BAL:PAR{1-16}:SSB SCS31
Scs32	Selects parameter S_{cs32} . S_{cs32} defines the way an unbalanced signal input to (unbalanced) port 2 on the DUT is transmitted to (balanced) port 3 on the DUT as a common mode signal.	:CALC{1-16}:FSIM:BAL:PAR{1-16}:SSB SCS32
Ssc13	Selects parameter S_{sc13} . S_{sc13} defines the way a common mode signal input to (balanced) port 3 on the DUT is transmitted to (unbalanced) port 1 on the DUT as an unbalanced signal.	:CALC{1-16}:FSIM:BAL:PAR{1-16}:SSB SSC13
Ssc23	Selects parameter S_{sc23} . S_{sc23} defines the way a common mode signal input to (balanced) port 3 on the DUT is transmitted to (unbalanced) port 2 on the DUT as an unbalanced signal.	:CALC{1-16}:FSIM:BAL:PAR{1-16}:SSB SSC23
Sdd33	Selects parameter S_{dd33} . S_{dd33} defines the way a differential signal input to (balanced) port 3 on the DUT is reflected as a differential signal.	:CALC{1-16}:FSIM:BAL:PAR{1-16}:SSB SDD33
Scd33	Selects parameter S_{cd33} . S_{cd33} defines the way a differential signal input to (balanced) port 3 on the DUT is reflected as a common mode signal.	:CALC{1-16}:FSIM:BAL:PAR{1-16}:SSB SCD33
Sdc33	Selects parameter S_{dc33} . S_{dc33} defines the way a common mode signal input to (balanced) port 3 on the DUT is reflected as a differential signal.	:CALC{1-16}:FSIM:BAL:PAR{1-16}:SSB SDC33

Softkey Functions
Measurement Menu (Balanced Measurement, SE-SE-Bal)

Key Operation	Function	SCPI Command
Meas	(Continued)	
Scc33	Selects parameter S_{cc33} . S_{cc33} defines the way a common mode signal input to (balanced) port 3 on the DUT is reflected as a common mode signal.	:CALC{1-16}:FSIM:BAL:PAR{1-16}:SSB SCC33
Imbalance1	Selects parameter Imbalance1.	:CALC{1-16}:FSIM:BAL:PAR{1-16}:SSB IMB1
Imbalance2	Selects parameter Imbalance2.	:CALC{1-16}:FSIM:BAL:PAR{1-16}:SSB IMB2
Sds31/Scs31	Selects parameter Sds31/Scs31.	:CALC{1-16}:FSIM:BAL:PAR{1-16}:SSB CMRR1
Sds32/Scs32	Selects parameter Sds32/Scs32.	:CALC{1-16}:FSIM:BAL:PAR{1-16}:SSB CMRR2
Imbalance3	Selects parameter Imbalance3.	:CALC{1-16}:FSIM:BAL:PAR{1-16}:SSB IMB3
Imbalance4	Selects parameter Imbalance4.	:CALC{1-16}:FSIM:BAL:PAR{1-16}:SSB IMB4
Return	Returns to the “E5070B/E5071B Menu (Top Menu)” on page 646.	

Preset Menu

Key Operation	Function	SCPI Command
Preset	Displays softkeys for restoring the preset conditions.	
OK	Restores the preset conditions.	:SYST:PRES
Cancel	Returns to the “E5070B/E5071B Menu (Top Menu)” on page 646.	

Save/Recall Menu

Key Operation	Function	SCPI Command
Save/Recall	Displays softkeys for saving and recalling data.	
Save State	Displays softkeys for saving settings.	
State01	Saves the current settings on the internal hard disk drive (D:) and names the saved file State01.sta.	:MMEM:STOR "State01.sta"
State02	Saves the current settings on the internal hard disk drive (D:) and names the saved file State02.sta.	:MMEM:STOR "State02.sta"
State03	Saves the current settings on the internal hard disk drive (D:) and names the saved file State03.sta.	:MMEM:STOR "State03.sta"
State04	Saves the current settings on the internal hard disk drive (D:) and names the saved file State04.sta.	:MMEM:STOR "State04.sta"
State05	Saves the current settings on the internal hard disk drive (D:) and names the saved file State05.sta.	:MMEM:STOR "State05.sta"
State06	Saves the current settings on the internal hard disk drive (D:) and names the saved file State06.sta.	:MMEM:STOR "State06.sta"
State07	Saves the current settings on the internal hard disk drive (D:) and names the saved file State07.sta.	:MMEM:STOR "State07.sta"
State08	Saves the current settings on the internal hard disk drive (D:) and names the saved file State08.sta.	:MMEM:STOR "State08.sta"
Autorec	Saves the current settings on the internal hard disk drive (D:) and names the saved file Autorec.sta. This file will be automatically loaded during the startup process and the analyzer settings will be restored.	:MMEM:STOR "Autorec.sta"
UserPres	Saves the current settings on the internal hard disk drive (D:) and names the saved file UserPres.sta. This file will be automatically loaded during the startup process or on presetting with the preset operation mode "User".	MMEM:STOR "UserPres.sta"
File Dialog...	Opens a dialog box for saving settings. This dialog box allows the user to save settings with an arbitrary name. This key is also used to save settings to a floppy disk.	:MMEM:STOR
Return	Returns to the softkey display screen one level higher.	
Recall State	Displays softkeys for recalling settings.	
State01	Recalls from the internal hard disk drive (D:) the settings saved as State01.sta.	:MMEM:LOAD "State01.sta"
State02	Recalls from the internal hard disk drive (D:) the settings saved as State02.sta.	:MMEM:LOAD "State02.sta"
State03	Recalls from the internal hard disk drive (D:) the settings saved as State03.sta.	:MMEM:LOAD "State03.sta"
State04	Recalls from the internal hard disk drive (D:) the settings saved as State04.sta.	:MMEM:LOAD "State04.sta"
State05	Recalls from the internal hard disk drive (D:) the settings saved as State05.sta.	:MMEM:LOAD "State05.sta"
State06	Recalls from the internal hard disk drive (D:) the settings saved as State06.sta.	:MMEM:LOAD "State06.sta"
State07	Recalls from the internal hard disk drive (D:) the settings saved as State07.sta.	:MMEM:LOAD "State07.sta"
State08	Recalls from the internal hard disk drive (D:) the settings saved as State08.sta.	:MMEM:LOAD "State08.sta"
Autorec	Recalls from the internal hard disk drive (D:) the settings saved as Autorec.sta.	:MMEM:LOAD "Autorec.sta"
UserPres	Recalls from the internal hard disk drive (D:) the settings saved as UserPres.sta.	MMEM:LOAD "UserPres.sta"
File Dialog...	Opens a dialog box for recalling settings. This dialog box allows the user to recall settings saved under arbitrary names. This key is also used to recall a file saved on a floppy disk.	:MMEM:LOAD
Return	Returns to the softkey display screen one level higher.	

Softkey Functions Save/Recall Menu

Key Operation	Function	SCPI Command
Save/Recall	(Continued)	
Recall by File Name	Displays softkeys that show the state file names for recalling settings.	
aaa	Recalls from the internal hard disk drive (D:\State) the settings saved as the filename used in the softkey label.	:MMEM:LOAD
bbb	Recalls from the internal hard disk drive (D:\State) the settings saved as the filename used in the softkey label.	:MMEM:LOAD
:		
xxx yyy zzz	Recalls from the internal hard disk drive (D:\State) the settings saved as the filename used in the softkey label.	:MMEM:LOAD
Return	Returns to the softkey display screen one level higher.	
Save Channel	Displays softkeys for saving settings for each channel into registers A to D (volatile memory).	
State A	Saves the current settings for each channel into registers A.	:MMEM:STOR:CHAN A
State B	Saves the current settings for each channel into registers B.	:MMEM:STOR:CHAN B
State C	Saves the current settings for each channel into registers C.	:MMEM:STOR:CHAN C
State D	Saves the current settings for each channel into registers D.	:MMEM:STOR:CHAN D
Clear States	Displays softkeys for clearing registers.	
OK	Clears all registers (A - D).	:MMEM:STOR:CHAN:CLE
Cancel	Returns to the softkey display screen one level higher.	
Return	Returns to the softkey display screen one level higher.	
Recall Channel	Displays softkeys for recalling settings for each channel from registers A to D (volatile memory).	
State A	Recalls the current settings for each channel from registers A.	:MMEM:LOAD:CHAN A
State B	Recalls the current settings for each channel from registers B.	:MMEM:LOAD:CHAN B
State C	Recalls the current settings for each channel from registers C.	:MMEM:LOAD:CHAN C
State D	Recalls the current settings for each channel from registers D.	:MMEM:LOAD:CHAN D
Return	Returns to the softkey display screen one level higher.	
Save Type	Displays softkeys for selecting the types of data to be saved.	
State Only	Saves settings only.	:MMEM:STOR:STYP STAT
State & Cal	Saves settings and calibration data.	:MMEM:STOR:STYP CST
State & Trace	Saves settings and trace data.	:MMEM:STOR:STYP DST
All	Saves settings, calibration data, and trace data.	:MMEM:STOR:STYP CDST
Cancel	Returns to the softkey display screen one level higher.	
Channel/Trace	Selects the save target for saving settings from all channels/traces (All) or displayed channel/traces only (Disp Only).	:MMEM:STOR:STYP SALL
Save Trace Data	Opens a dialog box for saving trace data as a CSV (comma-separated value) file. A CSV file can be opened in spreadsheet software such as Microsoft® Excel®.	:MMEM:STOR:FDAT
Explorer...	Opens Windows Explorer for organizing (cut, copy, paste, delete, rename, format) files and folders. The operation is same as Windows 98 computers. Users can modify files and folders in drive A: (floppy disk drive) and drive D: (user directory). Be sure not to modify any files and folders in drives other than drive A: and drive D:. Doing so will cause malfunctions.	:MMEM:MDIR :MMEM:COPY :MMEM:DEL

Key Operation	Function	SCPI Command
Save/Recall	(Continued)	
Save SnP	Displays softkeys to save measurement data into Touchstone format file.	
SnP Format	Displays softkeys to select data format of a file in which data is saved.	
Auto	Selects data format for the active channel's display format. If the display format does not correspond to data format of the Touchstone file, "real number - imaginary number format " is selected.	:MMEM:STOR:SNP:FORM AUTO
LinMag/Angle	Selects "linear magnitude format" as data format.	:MMEM:STOR:SNP:FORM MA
LogMag/Angle	Selects "log magnitude format" as data format.	:MMEM:STOR:SNP:FORM DB
Real/Imaginary	Selects "real number - imaginary number format" as data format.	:MMEM:STOR:SNP:FORM RI
s1p	Displays softkeys to save data to a Touchstone file with s1p file type.	
1	Saves measurement data of test port 1 to a Touchstone file.	:MMEM:STOR:SNP:TYPE:S1 P 1 :MMEM:STOR:SNP
2	Saves measurement data of test port 2 to a Touchstone file.	:MMEM:STOR:SNP:TYPE:S1 P 2 :MMEM:STOR:SNP
3	Saves measurement data of test port 3 to a Touchstone file.	:MMEM:STOR:SNP:TYPE:S1 P 3 :MMEM:STOR:SNP
4	Saves measurement data of test port 4 to a Touchstone file.	:MMEM:STOR:SNP:TYPE:S1 P 4 :MMEM:STOR:SNP
s2p	Displays softkeys to save data to a Touchstone file with s2p file type.	
1-2	Saves measurement data of test port 1 and 2 to a Touchstone file.	:MMEM:STOR:SNP:TYPE:S2 P 1,2 :MMEM:STOR:SNP
1-3	Saves measurement data of test port 1 and 3 to a Touchstone file.	:MMEM:STOR:SNP:TYPE:S2 P 1,3 :MMEM:STOR:SNP
1-4	Saves measurement data of test port 1 and 4 to a Touchstone file.	:MMEM:STOR:SNP:TYPE:S2 P 1,4 :MMEM:STOR:SNP
2-3	Saves measurement data of test port 2 and 3 to a Touchstone file.	:MMEM:STOR:SNP:TYPE:S2 P 2,3 :MMEM:STOR:SNP
2-4	Saves measurement data of test port 2 and 4 to a Touchstone file.	:MMEM:STOR:SNP:TYPE:S2 P 2,4 :MMEM:STOR:SNP
3-4	Saves measurement data of test port 3 and 4 to a Touchstone file.	:MMEM:STOR:SNP:TYPE:S2 P 3,4 :MMEM:STOR:SNP
s3p	Displays softkeys to save data to a Touchstone file with s3p file type.	
1-2-3	Saves measurement data of test port 1, 2, and 3 to a Touchstone file.	:MMEM:STOR:SNP:TYPE:S3 P 1,2,3 :MMEM:STOR:SNP
1-2-4	Saves measurement data of test port 1, 2, and 4 to a Touchstone file.	:MMEM:STOR:SNP:TYPE:S3 P 1,2,4 :MMEM:STOR:SNP
1-3-4	Saves measurement data of test port 1, 3, and 4 to a Touchstone file.	:MMEM:STOR:SNP:TYPE:S3 P 1,3,4 :MMEM:STOR:SNP
2-3-4	Saves measurement data of test port 2, 3, and 4 to a Touchstone file.	:MMEM:STOR:SNP:TYPE:S3 P 2,3,4 :MMEM:STOR:SNP

Softkey Functions
Save/Recall Menu

Key Operation	Function	SCPI Command
Save/Recall		
SnP		
s4p	Displays softkeys to save data to a Touchstone file with s4p file type.	
1-2-3-4	Saves measurement data of test port 1, 2, 3, and 4 to a Touchstone file.	:MMEM:STOR:SNP:TYPE:S4 P 1,2,3,4 :MMEM:STOR:SNP
Cancel	Returns to the "E5070B/E5071B Menu (Top Menu)" on page 646.	

Scale Menu

Key Operation	Function	SCPI Command
Scale	Displays softkeys for adjusting scales.	
Auto Scale	Automatically adjusts scales for the active trace.	:DISP:WIND{1-16}:TRAC{1-16}:Y:AUTO
Auto Scale All	Automatically adjusts scales for all traces within the active channel.	None
Divisions	Defines the number of divisions on the Y-axis of a rectangular display format. An even number from 4 to 30 must be used. Once set, it is then applied to all traces displayed in any rectangular display format within that channel.	:DISP:WIND{1-16}:TRAC{1-16}:Y:DIV
Scale/Div	In a rectangular format, defines the number of increments per division on the Y-axis. In the Smith chart format or polar format, defines the range (the displacement of the outermost circle). The setting applies to the active trace only.	:DISP:WIND{1-16}:TRAC{1-16}:Y:PDIV
Reference Position	Defines the position of the reference line on a rectangular display format. The position must be defined by using numbers assigned to the Y-axis between 0 (the origin, the X-axis) and the number of divisions (the highest scale). This setting applies only to the active trace. The reference line can also be moved by performing a drag-and-drop operation (pressing the mouse button on the object to be moved and releasing the button after dragging it to the desired position) on one of the reference line pointers (▶ and ◀).	:DISP:WIND{1-16}:TRAC{1-16}:Y:RPOS
Reference Value	Defines the value corresponding to the reference line on a rectangular display format. The setting applies only to the active trace.	:DISP:WIND{1-16}:TRAC{1-16}:Y:RLEV
Marker \neq Reference	Changes the value of the reference line to the response value of the active marker. The same function is also accessible from the “Marker Function Menu” on page 697.	:CALC{1-16}:MARK{1-10}:SET
Electrical Delay	Sets the electrical delay (second) and media type to be added for correcting a phase delay .	
Electrical Delay	Sets an electrical delay to the active trace. This function simulates the addition or deletion of a variable length lossless transfer line against the input of a receiver. It can be used to compensate for the electrical length of cables inside the DUT. Although the unit used is seconds, the length (meters) will be displayed in parentheses next to the input box based on the velocity coefficient used at the time.	:CALC{1-16}:CORR:EDEL:TIME
Media	Sets the media type required for the calculation to correct a phase delay.	:CALC{1-16}:CORR:EDEL:MED
Cutoff Frequency	Sets the cut-off frequency when the media type is waveguide.	:CALC{1-16}:CORR:EDEL:WGC
Phase Offset	Sets the values to be added or subtracted in phase measurement (phase offset) (×).	:CALC{1-16}:CORR:OFFS:PHAS
Return	Returns to the “E5070B/E5071B Menu (Top Menu)” on page 646.	

Stimulus Menu

Key Operation	Function	SCPI Command
Start	Sets the lowest frequency for sweeps. Also displays a menu (Stimulus Menu) for defining the sweep range.	:SENS{1-16}:FREQ:STAR
Start	Sets the starting frequency for sweeps.	:SENS{1-16}:FREQ:STAR
Stop	Sets the ending frequency for sweeps.	:SENS{1-16}:FREQ:STOP
Center	Sets the center frequency of the sweep range.	:SENS{1-16}:FREQ:CENT
Span	Sets the frequency span for sweeps.	:SENS{1-16}:FREQ:SPAN
Return	Returns to the “E5070B/E5071B Menu (Top Menu)” on page 646.	
Stop	Sets the ending frequency for sweeps. Also displays the Stimulus Menu same as Start .	:SENS{1-16}:FREQ:STOP
Center	Sets the center frequency of the sweep range. Also displays the Stimulus Menu same as Start .	:SENS{1-16}:FREQ:CENT
Span	Sets the frequency span for sweeps. Also displays the Stimulus Menu same as Start .	:SENS{1-16}:FREQ:SPAN

Sweep Setup Menu

Key Operation	Function	SCPI Command
Sweep Setup	Displays softkeys for setting up sweeps.	
Power	Displays the menu to set the stimulus signal output.	
Power	Sets the output power level of the internal signal source of the analyzer.	:SOUR{1-16}:POW
Power Ranges *1	Displays softkeys for selecting the power range.	
-20 to 10	Sets the power range to -20 dBm to 10 dBm.	:SOUR{1-16}:POW:ATT 0
-25 to 7	Sets the power range to -25 dBm to 7 dBm.	:SOUR{1-16}:POW:ATT 5
-30 to 2	Sets the power range to -30 dBm to 2 dBm.	:SOUR{1-16}:POW:ATT 10
-35 to -3	Sets the power range to -35 dBm to -3 dBm.	:SOUR{1-16}:POW:ATT 15
-40 to -8	Sets the power range to -40 dBm to -8 dBm.	:SOUR{1-16}:POW:ATT 20
-45 to -13	Sets the power range to -45 dBm to -13 dBm.	:SOUR{1-16}:POW:ATT 25
-50 to -18	Sets the power range to -50 dBm to -18 dBm.	:SOUR{1-16}:POW:ATT 30
-55 to -23	Sets the power range to -55 dBm to -23 dBm.	:SOUR{1-16}:POW:ATT 35
Cancel	Returns to the softkey display screen one level higher.	
Auto Range	Turn on/off of AUTO Power Range function.	:SOUR{1-16}:POW:ATT:AUTO
Port Couple	Turns on/off the port coupling for the power level.	:SOUR{1-16}:POW:PORT:COUP
Port Power	Displays the softkey to set the power level for each port when the port coupling is off.	
Port 1 Power	Sets the power level of port 1.	:SOUR{1-16}:POW:PORT1
Port 2 Power	Sets the power level of port 2.	:SOUR{1-16}:POW:PORT2
Port 3 Power	Sets the power level of port 3.	:SOUR{1-16}:POW:PORT3
Port 4 Power	Sets the power level of port 4.	:SOUR{1-16}:POW:PORT4
Slope [xx dB/GHz]	Sets the correction coefficient (correction amount of power level per 1 GHz) when the power slope feature is on.	:SOUR{1-16}:POW:SLOP
Slope [ON/OFF]	Turns on/off of the power slope feature.	:SOUR{1-16}:POW:SLOP:STAT
CW Freq	Sets the fixed frequency for the power sweep.	:SENS{1-16}:FREQ
RF Out	Turns on/off of the stimulus signal output.	:OUTP
Return	Returns to the softkey display screen one level higher.	
Sweep Time	Sets the sweep time for each source port. Inputting the value "0" as the sweep time causes the analyzer to go into automatic sweep time mode.	:SENS{1-16}:SWE:TIME :SENS{1-16}:SWE:TIME:AUTO
Sweep Delay	Sets the wait (delay) time before starting a sweep for each source port.	:SENS{1-16}:SWE:DEL
Sweep Mode	Displays softkeys for selecting the sweep mode.	
Std Stepped	Selects the stepped mode.	:SENS{1-16}:SWE:GEN STEP
Std Swept	Selects the swept mode.	:SENS{1-16}:SWE:GEN ANAL
Fast Stepped	Selects the fast stepped mode.	:SENS{1-16}:SWE:GEN FST
Fast Swept	Selects the fast swept mode.	:SENS{1-16}:SWE:GEN FAN
Cancel	Returns to the softkey display screen one level higher.	
Points	Sets the number of points per sweep. The number of points should be from 2 to 1601.	:SENS{1-16}:SWE:POIN
Sweep Type	Displays softkeys for selecting the sweep type.	
Lin Freq	Selects linear frequency sweep.	:SENS{1-16}:SWE:TYPE LIN
Log Freq	Selects logarithmic frequency sweep.	:SENS{1-16}:SWE:TYPE LOG
Segment	Selects segment sweep.	:SENS{1-16}:SWE:TYPE SEG
Power Sweep	Selects power sweep.	:SENS{1-16}:SWE:TYPE LOG

Softkey Functions Sweep Setup Menu

Key Operation	Function	SCPI Command
Sweep Setup	(Continued)	
Sweep Type		
Cancel	Returns to the softkey display screen one level higher.	
Edit Segment Table	Displays the segment sweep setup table as well as softkeys for editing the segment table.	
Freq Mode	Alternates the setup mode for the sweep range between two methods: one using the starting and ending frequencies (Start/Stop), and the other using the center frequency and a frequency span (Center/Span).	:SENS{1-16};SEGM:DATA
List IFBW	Enables or disables the IF bandwidth display in the segment table.	:SENS{1-16};SEGM:DATA
List Power	Enables or disables the power level display in the segment table.	:SENS{1-16};SEGM:DATA
List Delay	Enables or disables the segment delay display in the segment table.	:SENS{1-16};SEGM:DATA
List Sweep Mode	Enables or disables the segment sweep mode display in the segment table.	:SENS{1-16};SEGM:DATA
List Time	Enables or disables the segment sweep time display in the segment table.	:SENS{1-16};SEGM:DATA
Delete	Deletes from the segment table the segment upon which the cursor is currently located. If the cursor is not displayed, the segment on the bottom will be deleted.	:SENS{1-16};SEGM:DATA
Add	Adds a new segment immediately above the segment upon which the cursor is currently located. If the cursor is not displayed, a new segment will be added to the bottom of the table.	:SENS{1-16};SEGM:DATA
Clear Segment Table	Displays softkeys for clearing elements of the segment table.	
OK	Deletes all segments in the segment table.	None
Cancel	Returns to the softkey display screen one level higher.	
Export to CSV File	Exports (saves data in file formats used by other software) the segment table as a CSV (comma-separated value) file.	:MMEM:STOR:SEGM
Import from CSV File	Imports (loads a file that is written in a format used by other software) a CSV (comma-separated value) file to the segment table of E5070B/E5071B.	:MMEM:LOAD:SEGM
Return	Returns to the softkey display screen one level higher.	
Segment Display	Selects linear frequency (Freq Base) or selects the order of measurements (1, 2, ..., N; where N refers to the number of points) (Order Base) for drawing the X-axis of a rectangular display format in a segment sweep.	:DISP:WIND{1-16}:X:SPAC LIN :DISP:WIND{1-16}:X:SPAC OBAS
Frequency Offset	Displays the softkey to setup the frequency offset.	
Frequency Offset	Turns on/off of the frequency offset feature.	:SENS{1-16}:OFFS
Port 1	Displays the softkey to setup the frequency offset parameter for test port 1.	
Multiplier	Set the multiplier of the base frequency ^{*2} .	:SENS{1-16}:OFFS:PORT{1-4}:MULT
Divisor	Set the divisor of the base frequency ^{*2} .	:SENS{1-16}:OFFS:PORT{1-4}:DIV
Offset	Set the offset for the base frequency ^{*2} .	:SENS{1-16}:OFFS:PORT{1-4}:OFFS
Start	Set the start frequency.	:SENS{1-16}:OFFS:PORT{1-4}:STAR
Stop	Set the stop frequency.	:SENS{1-16}:OFFS:PORT{1-4}:STOP
Return	Returns to the softkey display screen one level higher.	
Port 2 to Port 4	Displays the softkey to setup the frequency offset parameters for test port 2 to 4. Lower level softkeys are the same as the Port 1 .	
External Source	Displays the softkey to setup the external signal source.	
LO Frequency	Set the external signal source frequency.	:SENS{1-16}:OFFS:LOC:STAT
Multiplier	Set the multiplier of the base frequency ^{*2} .	:SENS{1-16}:OFFS:LOC:MULT
Divisor	Set the divisor of the base frequency ^{*2} .	:SENS{1-16}:OFFS:LOC:DIV

Key Operation	Function	SCPI Command
Sweep Setup	(Continued)	
Frequency Offset		
External Source		
Offset	Set the offset for the base frequency* ² .	:SENS{1-16}:OFFS:LOC:OFFS
Start	Set the start frequency.	:SENS{1-16}:OFFS:LOC:STAR
Stop	Set the stop frequency.	:SENS{1-16}:OFFS:LOC:STOP
Control	Turns on/off of the external signal source control with GPIB.	:SENS{1-16}:OFFS:LOC:CONT
Power	Set the power level.	:SENS{1-16}:OFFS:LOC:POW
Slope [xdB/GHz]	Set the power slope.	:SENS{1-16}:OFFS:LOC:POW:SLOP
Slope [ON/OFF]	Turns on/off of the power slope.	:SENS{1-16}:OFFS:LOC:POW:SLOP :STAT
Return	Returns to the softkey display screen one level higher.	
Avoid Spurious	Turns on/off of the avoid spurious.	:SENS{1-16}:OFFS:ASP
X-Axis	Displays the softkey to select the x-axis frequency data.	
Base	Selects base frequency* ² when the frequency offset turns on.	:CALC{1-16}:OFFS:XAX
Stimulus	Selects source port frequency when the frequency offset turns on.	:CALC{1-16}:OFFS:XAX
Response	Selects receiver port frequency when the frequency offset turns on.	:CALC{1-16}:OFFS:XAX
Normal	Selects base frequency* ² when the frequency offset turns off.	:CALC{1-16}:MIX:XAX
RF + LO	Selects RF+LO frequency when the frequency offset turns off.	:CALC{1-16}:MIX:XAX
RF - LO	Selects RF-LO frequency when the frequency offset turns off.	:CALC{1-16}:MIX:XAX
LO - RF	Selects LO-RF frequency when the frequency offset turns off.	:CALC{1-16}:MIX:XAX
Cancel	Returns to the softkey display screen one level higher.	
Return	Returns to the softkey display screen one level higher.	
Return	Returns to the "E5070B/E5071B Menu (Top Menu)" on page 646.	

*1. Only with Options 214, 314, and 414.

*2. The base frequency is the frequency that is set by using **Start** and **Stop** keys.

System Menu

Key Operation	Function	SCPI Command
System	Displays softkeys for performing limit tests and accessing control and management functions on the analyzer.	
Print	Outputs the current screen to a printer.	:HCOP
Abort Printing	Aborts printing.	:HCOP:ABOR
Printer Setup	Opens a dialog box for setting up the printer.	None
Invert Image	Inverts the colors of the screen display.	:HCOP:IMAG
Dump Screen Image	Opens a dialog box for saving the screen image in BMP (Windows or OS/2 bitmap) format.	:MMEM:STOR:IMAG
Multiport Test Set Setup	Displays softkeys for setting the E5091A control.	
Test Set 1	Displays the model selected for test set 1.	
Select Test Set	Displays the selected model.	
E5091_9	Selects the 9-port model (E5091A-009).	:SENS{1-16}:MULT1:NAME E5091_9
E5091_13	Selects the 13-port model (E5091A-016).	:SENS{1-16}:MULT1:NAME E5091_13
E5091_16	Selects the 16-port model (E5091A-016).	:SENS{1-16}:MULT1:NAME E5091_16
Cancel	Returns to the softkey display screen one level higher.	
Control	Enables/disables control of the E5091A.	:SENS{1-16}:MULT1:STAT
Property	Enables/disables the display of the E5091A properties.	:SENS{1-16}:MULT1:DISP
Port 1	Displays softkeys for selecting a test port of the E5091A to which you want to connect port 1.	
A1	Selects test port A1.	:SENS{1-16}:MULT1:PORT1 A1
A2*1	Selects test port A2.	:SENS{1-16}:MULT1:PORT1 A2
A3*1	Selects test port A3.	:SENS{1-16}:MULT1:PORT1 A3
A4*1	Selects test port A4.	:SENS{1-16}:MULT1:PORT1 A4
A*1	Selects test port A.	:SENS{1-16}:MULT1:PORT1 A
T1	Selects test port T1.	:SENS{1-16}:MULT1:PORT1 T1
T2*1	Selects test port T2.	:SENS{1-16}:MULT1:PORT1 T2
T3*1	Selects test port T3.	:SENS{1-16}:MULT1:PORT1 T3
Cancel	Returns to the softkey display screen one level higher.	
Port 2	Displays softkeys for selecting a test port of the E5091A to which you want to connect port 2.	
B1*1	Selects test port B1.	:SENS{1-16}:MULT1:PORT2 B1
B2*1	Selects test port B2.	:SENS{1-16}:MULT1:PORT2 B2
B3*1	Selects test port B3.	:SENS{1-16}:MULT1:PORT2 B3
B4*1	Selects test port B4.	:SENS{1-16}:MULT1:PORT2 B4
T1	Selects test port T1.	:SENS{1-16}:MULT1:PORT2 T1
T2	Selects test port T2.	:SENS{1-16}:MULT1:PORT2 T2
T3*1	Selects test port T3.	:SENS{1-16}:MULT1:PORT2 T3
T4*1	Selects test port T4.	:SENS{1-16}:MULT1:PORT2 T4
Cancel	Returns to the softkey display screen one level higher.	

Key Operation	Function	SCPI Command
System		
Multiport Test Set Setup	Displays softkeys for setting the E5091A control.	
Test Set 1	Displays the model selected for test set 1 (ID=1)	
Port 3	Displays softkeys for selecting a test port of the E5091A to which you want to connect port 3.	
R1+	Selects test port R1+.	:SENS{1-16}:MULT1:PORT3 R1
R2+	Selects test port R2+.	:SENS{1-16}:MULT1:PORT3 R2
R3+	Selects test port R3+.	Selects test port R2+.
R4+^{*1}	Selects test port R4+.	Selects test port R2+.
Cancel	Returns to the softkey display screen one level higher.	
Port 4	Displays softkeys for selecting a test port of the E5091A to which you want to connect port 4.	
R1-	Selects test port R1-.	:SENS{1-16}:MULT1:PORT4 R1
R2-	Selects test port R2-.	:SENS{1-16}:MULT1:PORT4 R2
R3-	Selects test port R3-.	:SENS{1-16}:MULT1:PORT4 R3
R4-^{*1}	Selects test port R4-.	:SENS{1-16}:MULT1:PORT4 R4
Cancel	Returns to the softkey display screen one level higher.	
Port 5^{*1}	Displays softkeys for selecting a test port of the E5091A to which you want to connect port 5.	
X1	Selects test port X1.	:SENS{1-16}:MULT1:PORT5 X1
X2	Selects test port X2.	:SENS{1-16}:MULT1:PORT5 X2
Cancel	Returns to the softkey display screen one level higher.	
Port 6^{*1}	Displays softkeys for selecting a test port of the E5091A to which you want to connect port 6.	
Y1	Selects test port Y1.	:SENS{1-16}:MULT1:PORT6 Y1
Y2	Selects test port Y1.	:SENS{1-16}:MULT1:PORT6 Y2
Cancel	Returns to the softkey display screen one level higher.	
Port 7^{*1}	Displays softkeys for selecting a test port of the E5091A to which you want to connect test port 7.	
Z1	Selects test port Z1.	:SENS{1-16}:MULT1:PORT7 Z1
Z2	Selects test port Z2.	:SENS{1-16}:MULT1:PORT7 Z2
Cancel	Returns to the softkey display screen one level higher.	
Control Lines	Displays softkeys for setting HIGH/LOW of control lines.	
Line 1	Sets HIGH/LOW of line 1.	:SENS{1-16}:MULT1:OUTP
Line 2	Sets HIGH/LOW of line 2.	:SENS{1-16}:MULT1:OUTP
Line 3	Sets HIGH/LOW of line 3.	:SENS{1-16}:MULT1:OUTP
Line 4	Sets HIGH/LOW of line 4.	:SENS{1-16}:MULT1:OUTP
Line 5	Sets HIGH/LOW of line 5.	:SENS{1-16}:MULT1:OUTP
Line 6	Sets HIGH/LOW of line 6.	:SENS{1-16}:MULT1:OUTP
Line 7	Sets HIGH/LOW of line 7.	:SENS{1-16}:MULT1:OUTP
Line 8	Sets HIGH/LOW of line 8.	:SENS{1-16}:MULT1:OUTP
Return	Returns to the softkey display screen one level higher.	
Return	Returns to the softkey display screen one level higher.	
Test Set 2	Displays the model selected for test set 2.	
Return	Returns to the softkey display screen one level higher.	

Softkey Functions System Menu

Key Operation	Function	SCPI Command
System		
Misc Setup	Displays softkeys for setting up the beeper function, GPIB, Network, internal clock, key lock function and color of display image.	
Beeper	Displays softkeys for setting up the beeper function.	
Beep Complete	Enables or disables beeps at the end of processes. When enabled, the user will be notified with a beep when a measurement has completed or settings have been saved.	:SYST:BEEP:COMP:STAT
Test Beep Complete	Tests the beeping sound.	:SYST:BEEP:COMP:IMM
Beep Warning	Enables or disables warning beeps. When enabled, all warning messages will be accompanied by beeps.	:SYST:BEEP:WARN:STAT
Test Beep Warning	Tests the beeping sound for warnings.	:SYST:BEEP:WARN:IMM
Return	Returns to the softkey display screen one level higher.	
GPIB Setup	Displays softkeys for setting up the GPIB.	
Talker/Listener Address	Sets the address for controlling the analyzer from a controller via GPIB.	None
System Controller Configuration	Opens a dialog box for configuring the system controller (USB/GPIB interface).	None
Power Meater Address	Sets an address of a power meter used for the power calibration.	:SYST:COMM:GPIB:PMET:ADDR
Signal Generator Address	Displays the softkey to set the address, type, and command for controlling an external signal generator.	
Address	Sets the GPIB address of an external signal generator.	:SYST:COMM:GPIB:SGEN:ADDR
Switching Time	Sets the waiting time after setting the frequency and power level to an external signal generator.	:SYST:COMM:GPIB:SGEN:DWEL
Custom Commands	Displays the softkey to set a type of external signal generator as user defined. Also displays the softkey to set user defined commands for setting the frequency, power level, RF ON, and preset of an external signal generator.	:SYST:COMM:GPIB:SGEN:TYPE 1
Preset	Sets the preset GPIB command.	:SYST:COMM:GPIB:SGEN:CCOM:PRES
Turn RF Out On	Sets the RF power ON.	:SYST:COMM:GPIB:SGEN:CCOM:RFON
Set Frequency	Sets the frequency.	:SYST:COMM:GPIB:SGEN:CCOM:FREQ
Set Power Level	Sets the power level.	:SYST:COMM:GPIB:SGEN:CCOM:POW
Return	Returns to the softkey display screen one level higher.	
8643A, 8644B, 8664A, 8665A/B	Sets a type of signal generator as 8643A, 8644B, 8664A, and 8665A/B.	:SYST:COMM:GPIB:SGEN:TYPE 2
8648A/B/C/D, ESG/PSG Series	Sets a type of signal generator as 8648A/B/C/D, ESG, and PSG series.	:SYST:COMM:GPIB:SGEN:TYPE 3
Return	Returns to the softkey display screen one level higher.	
Return	Returns to the softkey display screen one level higher.	

Key Operation	Function	SCPI Command
System	(Continued)	
Misc Setup		
Network Setup	Displays softkeys for configuring network settings.	
Telnet Server	Enables or disables the telnet server function.	None
SICL-LAN Server	Enables or disables the SICL-LAN server function.	None
SICL-LAN Address	Sets the address for controlling the analyzer from a controller via SICL-LAN.	None
Web Server	Enables or disables the Web server function.	None
VNC Server Configuration...	Opens a window for configuring the Virtual Network Computing Server settings.	None
Network Identification	Opens a dialog box for configuring the analyzer's identification such as a computer name.	None
Network Configuration	Opens a window for configuring network settings.	None
Return	Returns to the softkey display screen one level higher.	
Clock Setup	Displays softkeys for setting the internal clock.	
Set Date and Time	Opens a dialog box for setting the date and time of the internal clock.	:SYST:DATE :SYST:TIME
Show Clock	Enables or disables the time and date display inside the status bar.	:DISP:CLOC
Return	Returns to the softkey display screen one level higher.	
Key Lock	Displays softkeys for locking the keyboard and the mouse.	
Front Panel & Keyboard Lock	Locks the front panel keys and the keyboard (key operations disabled).	:SYST:KLOC:KBD
Touch Screen & Mouse Lock	Locks the touch screen ^{*2} and the mouse (mouse operations disabled).	:SYST:KLOC:MOUS
Return	Returns to the softkey display screen one level higher.	
Color Setup	Displays softkeys for setting up the color of display image.	
Normal	Displays softkeys for setting up the color of the normal display.	
Data Trace 1	Displays softkeys for setting up the color of the data trace of Trace 1.	
Red	Displays softkeys for setting up the amount of red in a color.	
0	Sets 0.	:DISP:COL{1-2}:TRAC1:DATA
1	Sets 1.	:DISP:COL{1-2}:TRAC1:DATA
:	:	:
5	Sets 5.	:DISP:COL{1-2}:TRAC1:DATA
Cancel	Returns to the softkey display screen one level higher.	
Green	Displays softkeys for setting up the amount of green in a color. The lower-level softkeys are the same as those for Red.	
Blue	Displays softkeys for setting up the amount of blue in a color. The lower-level softkeys are the same as those for Red.	
Return	Returns to the softkey display screen one level higher.	
Data Trace 2	Displays softkeys for setting up the color of the data trace of Trace 2. The lower-level softkeys are the same as those for Data Trace 1.	:DISP:COL{1-2}:TRAC2:DATA
:	:	:
Data Trace 9	Displays softkeys for setting up the color of the data trace of Trace 9. The lower-level softkeys are the same as those for Data Trace 1.	:DISP:COL{1-2}:TRAC9:DATA

Softkey Functions System Menu

Key Operation	Function	SCPI Command
System	(Continued)	
Misc Setup		
Color Setup		
Normal		
Mem Trace 1	Displays softkeys for setting up the color of the memory trace of Trace 1. The lower-level softkeys are the same as those for Data Trace 1 .	:DISP:COL{1-2};TRAC1:MEM
:	:	:
Mem Trace 9	Displays softkeys for setting up the color of the memory trace of Trace 9. The lower-level softkeys are the same as those for Data Trace 1 .	:DISP:COL{1-2};TRAC9:MEM
Graticule Main	Displays softkeys for setting up the color of the graticule labels and the outer frame of graphs. The lower-level softkeys are the same as those for Data Trace 1 .	:DISP:COL{1-2};GRAT1
Graticule Sub	Displays softkeys for setting up the color of the graticule lines in graphs. The lower-level softkeys are the same as those for Data Trace 1 .	:DISP:COL{1-2};GRAT2
Limit Fail	Displays softkeys for setting up the color of the fail label of the limit test. The lower-level softkeys are the same as those for Data Trace 1 .	:DISP:COL{1-2};LIM1
Limit Line	Displays softkeys for setting up the color of the limit line of the limit test. The lower-level softkeys are the same as those for Data Trace 1 .	:DISP:COL{1-2};LIM2
Background	Displays softkeys for setting up the color of the background. The lower-level softkeys are the same as those for Data Trace 1 .	:DISP:COL{1-2};BACK
Reset Color	Resets the color to the factory setting state.	:DISP:COL{1-2};RES
Return	Returns to the softkey display screen one level higher.	
Invert	Displays softkeys for setting up the color of the inverted display. The lower-level softkeys are the same as those for Normal .	
Return	Returns to the softkey display screen one level higher.	
Channel/Trace Setup	Displays softkeys for setting up the maximum numbers of the channels and traces.	
1 Channels 4 Traces	Sets the maximum number of channels to 1 and the maximum number of traces to 4.	None
2 Channels 4 Traces	Sets the maximum number of channels to 2 and the maximum number of traces to 4.	None
4 Channels 16 Traces	Sets the maximum number of channels to 4 and the maximum number of traces to 16.	None
9 Channels 9 Traces	Sets the maximum number of channels to 9 and the maximum number of traces to 9.	None
12 Channels 6 Traces	Sets the maximum number of channels to 12 and the maximum number of traces to 6.	None
16 Channels 4 Traces	Sets the maximum number of channels to 16 and the maximum number of traces to 4.	None
1 Ch / 4 Tr 200001 Points	Sets the maximum number of channels to 1, the maximum number of traces to 4, and the upper limit of the measurement point to 20001.	None
Return	Returns to the softkey display screen one level higher.	
Preset Setup	Displays softkeys to executes the preset function.	
State	Displays the softkeys to set the type of preset to be executed.	
Factory	Executes the preset function to recall the factory state.	None
User	Executes the preset function to recall a user-specified state.	None
Confirm	Toggles on/off whether to display the softkeys for confirmation at the execution of the preset function.	None

Key Operation	Function	SCPI Command
System	(Continued)	
Misc Setup		
Control Panel...	Opens a control panel window.	None
Return	Returns to the softkey display screen one level higher.	
Backlight	Turns the backlight for the LCD screen on/off.	:SYST:BACK
Firmware Revision	Displays the firmware revision information in a dialog box.	*IDN?
Service Menu	Displays softkeys for maintenance services.	
Test Menu	Displays softkeys for self diagnosis functions.	
Power On Test	Executes an internal test.	None
Display	Executes a display test.	None
Front Panel	Tests the front panel keys (hardkeys).	None
Adjust Touch Screen	Executes calibration of the touch screen.	None
Return	Returns to the softkey display screen one level higher.	
System Correction	Turns ON/OFF error correction, which uses system calibration data. If user calibration using [Cal] is executed properly and the error correction is valid, you can turn off system error correction and reduce measurement time.	:SYST:CORR
Avoid Spurious	Turns ON/OFF the avoid spurious mode.	:SENS{1-16};SWE:ASP
High Temperature	Turns ON/OFF the high temperature measurement mode. When the high temperature measurement mode is turned on, drift error can be reduced in the ambient temperature range of 28×C to 33×C. If you use the analyzer within the range of 23×C ± 5×C, you must turn off this function.	:SYST:TEMP:HIGH
Init Src Ctrl	Turns ON/OFF the initial source port control function.	:SYST:ISPC
Init Src Port	Display softkeys for the initial source port control function.	
1	Selects set port to 1.	:SYST:ISPC:PORT 1
2	Selects set port to 2.	:SYST:ISPC:PORT 2
3	Selects set port to 3.	:SYST:ISPC:PORT 3
4	Selects set port to 4.	:SYST:ISPC:PORT 4
Cancel	Returns to the softkey display screen one level higher.	
Security Level	Displays softkeys for the security level of the frequency blank display function.	
None	Turns off the frequency blank display function.	:SYST:SEC:LEV NON
Low	Turns on the frequency blank display function (security level : LOW).	:SYST:SEC:LEV LOW
High	Turns on the frequency blank display function (security level : HIGH).	:SYST:SEC:LEV HIGH
Cancel	Returns to the softkey display screen one level higher.	

Softkey Functions System Menu

Key Operation	Function	SCPI Command
System	(Continued)	
Service Menu	Displays softkeys for maintenance services.	
Channel/Trace Setup		
16 Ch / 16 Tr 801 Points	Sets the maximum number of channels to 16, the maximum number of traces to 16, and the upper limit of the measurement point to 801.	None
24 Ch / 9 Tr 801 Points	Sets the maximum number of channels to 24, the maximum number of traces to 9, and the upper limit of the measurement point to 801.	None
36 Ch / 9 Tr 401 Points	Sets the maximum number of channels to 36, the maximum number of traces to 9, and the upper limit of the measurement point to 401.	None
Return	Returns to the softkey display screen one level higher.	
Enable Options	Displays softkeys for other options.	
Restart Firmware	Executes a firmware restart.	
Update Firmware	Executes a firmware update.	
Service Functions	Displays softkeys for performing service functions. This option is not open to average users.	
Return	Returns to the softkey display screen one level higher.	
Return	Returns to the "E5070B/E5071B Menu (Top Menu)" on page 646.	

*1. Only with Option E5091A-016

*2. Only with Options E5070B/E5071B-016

Trigger Menu

Key Operation	Function	SCPI Command
Trigger	Displays following softkeys for setting the trigger. Once the trigger mode is set, measurements are executed according to the trigger mode even when the channel is no longer on display due to reduction of the number of channels to be displayed from the “Display Menu” on page 688.	
Hold	Sets the active channel trigger mode to “hold”. A trigger sent from the trigger source to that channel will not prompt a sweep.	:INIT{1-16}:CONT
Single	Sets the active channel trigger mode to “single”. A trigger sent from the trigger source to that channel prompts a single sweep and then the sweep mode changes to “hold.”	:INIT{1-16}
Continuous	Sets the active channel trigger mode to “continuous”. Each trigger sent from the trigger source to that channel prompts a single sweep.	:INIT{1-16}:CONT
Hold All Channels	Sets all channel trigger modes to “hold”.	None
Continuous Disp Channels	Sets all displayed channel trigger modes to “continuous”. See “Setting channel display (layout of channel windows)” on page 62 for details about displayed channels.	None
Trigger Source	Displays softkeys for selecting the trigger source.	
Internal	Selects the “internal” trigger source of the analyzer. The analyzer will generate a series of trigger signals. A trigger, once generated, is sent to all channels in order no matter how many channels are displayed.*1	:TRIG:SOUR INT
External	Selects the “external” trigger source. A signal input to the external trigger input terminal (BNC(f) connector) on the rear panel will be used as the trigger source. A trigger, once generated, is sent to all channels in order no matter how many channels are displayed.*1	:TRIG:SOUR EXT
Manual	Sets the trigger source to “manual”. Pressing the Trigger key in the Trigger Menu generates a trigger. A trigger, once generated, is sent to all channels in order no matter how many channels are displayed.*1	:TRIG:SOUR MAN
Bus	Sets the analyzer trigger source to “bus”. A trigger is generated by sending a trigger command through the GPIB or a LAN. A trigger, once generated, is sent to all channels in order no matter how many channels are displayed.*1	:TRIG:SOUR BUS
Cancel	Returns to the softkey display screen one level higher.	
Trigger Event	Turns ON/OFF the point trigger function.	:TRIG:POIN
Trigger Scope	Sets the effective range to be triggered.	:TRIG:SCOP
Restart	Aborts a sweep.	:ABOR
Trigger	When the trigger source is set to “manual”, generates a trigger.	:TRIG
Ext Trig Delay	When the low-latency external trigger is set to “ON”, sets the trigger delay time.	:TRIG:SEQ:EXT:DEL
Low Latency	Enables/disables the low-latency external trigger.	:TRIG:SEQ:EXT:LLAT
Return	Returns to the “E5070B/E5071B Menu (Top Menu)” on page 646.	

*1. It depends on the settings of trigger scope.

Softkey Functions
Trigger Menu

E **General Principles of Operation**

This chapter explains the general principles of operation for the Agilent E5070B/E5071B.

System Description

A network analyzer supplies a sweep signal to a DUT, measures its transmission and reflection, and displays the results as ratios against the input signal from the signal source. The E5070B/E5071B network analyzer consists of the circuit modules shown in Figure E-1.

Figure E-1 System Diagram for the E5070B/E5071B Network Analyzer

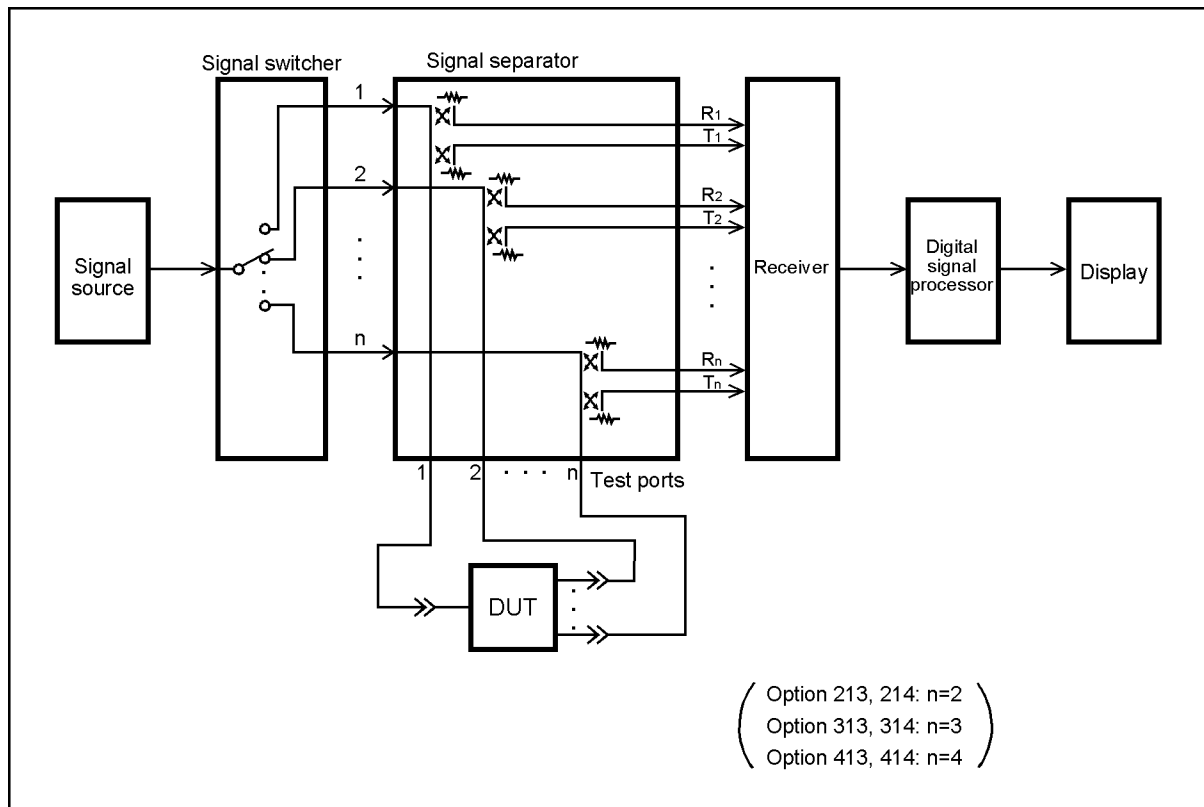

e5070aue124

Synthesized Source

The synthesized source generates an RF sweep signal in the following frequency range.

- E5070B: 300 kHz ~ 3 GHz
- E5071B: 300 kHz ~ 8.5 GHz

The signal source is phase-locked to a highly reliable quartz crystal oscillator to maintain a high level of accuracy in its frequency as well as to achieve precise phase measurements. The level of RF output power is controlled within the range of -15 dBm ~ $+10$ dBm by the internal ALC (automatic leveling control) circuit. The E5070B/E5071B with option 214, 314, or 414 comes with a source-stepping attenuator which allows the user to set the power level in the range of -50 dBm ~ $+10$ dBm.

Source Switcher

The source switcher is used to switch test ports to which the RF signal is supplied from the source.

Signal Separator

The signal separator consists of directivity couplers that detect input and output signals at the test ports. On a test port to which a signal is output, the output signal and the reflection from the DUT are detected as the reference signal (R) and the test signal (T), respectively. On the other ports, the signal that is transmitted through the DUT is detected as the test signal (T). All signals are then sent to the receiver.

Receiver

Each signal that is sent to the receiver is first converted into an IF signal by a mixer and then converted into a digital signal by an ADC (analog to digital converter). These processes are applied to each signal independently. The digital data is then analyzed by a micro processor and measurement results will be displayed on the screen.

Data Processing

The internal data processing flowchart for the E5070B/E5071B is shown in Figure E-2.

Figure E-2 Data Processing Flowchart

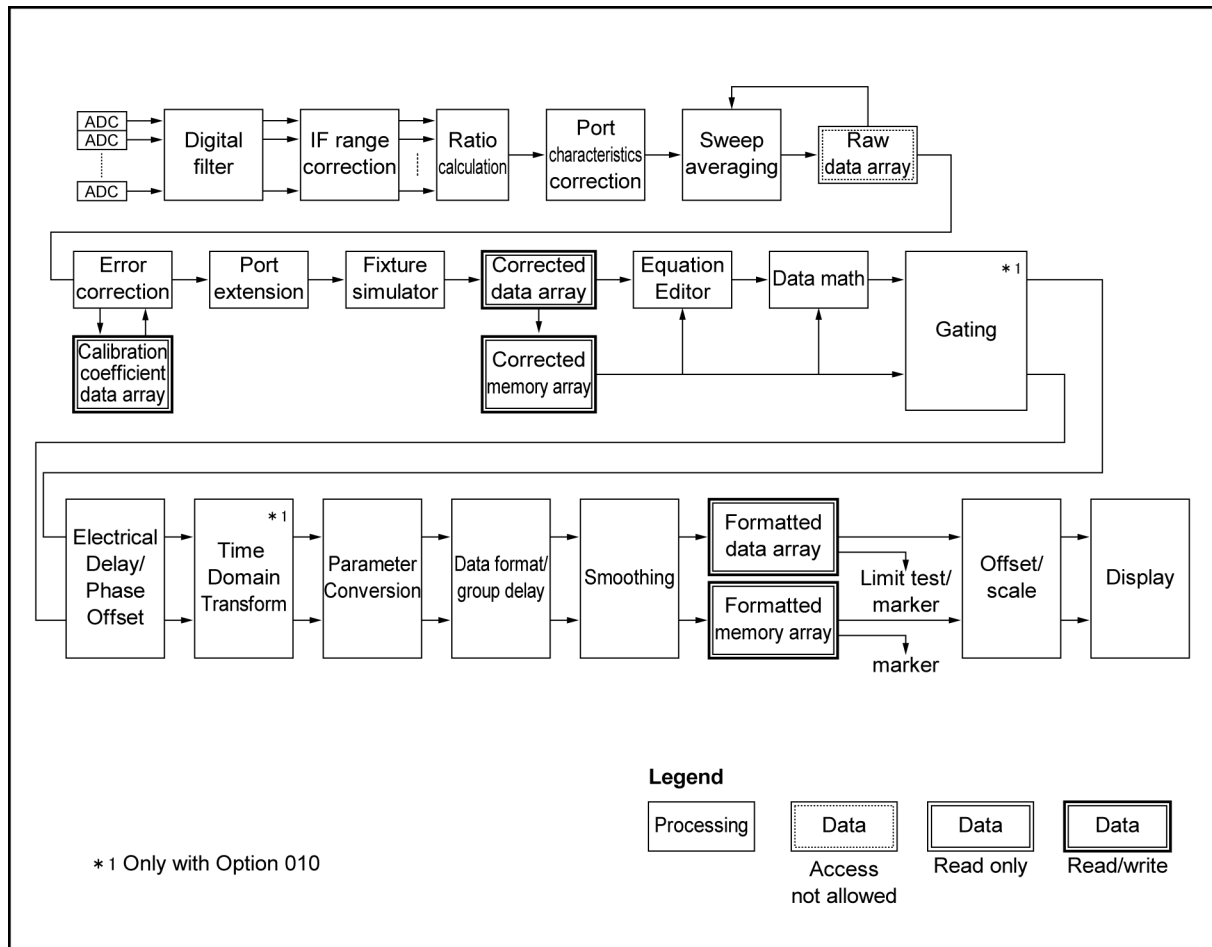

e5070bue10003

ADC

The ADCs (analog-to-digital converters) convert analog signals fed to the receiver and converted into IF signals (R_1, R_2, \dots, R_n and T_1, T_2, \dots, T_n) into digital signals. One ADC is available for each signal and the conversion takes place simultaneously.

Digital Filter

The digital filter performs a discrete Fourier transformation (DFT) and picks up IF signals. Each IF signal is then converted into a complex number that has a real part and an imaginary part. The IF bandwidth of the analyzer is equivalent to the bandwidth of the DFT filter. The IF bandwidth can be set in the range of 10 Hz ~ 100 kHz.

IF Range Correction

Input signals that went through ranging at the receiver are reverted (corrected) to previous values before the ranging.

Ratio Calculation

The ratio between two signals is determined by performing divisions on complex numbers. In the case of absolute measurements (Option 008), the ratio of complex number can not be calculated.

Port Characteristics Correction

The equivalent source match error, the directivity error, and the tracking error of each test port bridge are corrected. In the case of absolute measurements (Option 008), the gain of each test port is corrected.

Sweep Averaging

The average of complex indices is determined based on data obtained from multiple sweep measurements. Sweep averaging is effective in reducing random noise in measurements.

Raw Data Array

The results from all data processing done up to this point are stored in this array as raw data. All prior data processing is performed as each sweep takes place. When the full N-port error correction (N=2 to 4) is enabled, all $4 \times N$ S parameters are stored in the raw data array and used in error correction. The user is not allowed to access (read/write) this raw data array.

Error Correction/Calibration Coefficient Data Array

When error correction is enabled, the process eliminates the system errors that are reproducible and stored in the calibration coefficient data array. It accommodates everything from the simple vector normalization to the full 12-term error correction. The user is allowed to access (read/write) this calibration coefficient data array.

Port Extension

This process carries out a simulation of adding or eliminating a variable length no-loss transmission path on each test port so that the reference plane of calibration is moved. The port extension is defined by an electrical delay (sec).

Fixture Simulator

A data conversion by the fixture simulator function is executed. The fixture simulator function is a collective term for six different functions: balanced-unbalanced conversion, addition of matching circuits, port reference impedance conversion, network elimination, addition of differential matching circuits, and differential reference impedance conversion.

Corrected Data Array

Unlike the raw data array, this array stores the results obtained after error corrections, port extensions, or the fixture simulator functions are applied. The user is allowed to read/write data from/to the corrected data array.

Corrected Memory Array

By pressing - Data → Mem, the contents of the corrected data array will be copied to this array. The user is allowed to read/write data from/to the corrected memory array.

Equation Editor

Data processing is carried out by creating an equation based on the corrected data array.

Data Math

Data processing is carried out using the corrected data array and the corrected memory array. Four types of data processing – addition, subtraction, multiplication, and division – are available.

Electrical Delay/Phase Offset

An electrical delay and a phase offset are applied to each trace. By setting an electrical delay, a linear phase that is proportional to the frequency will be added or subtracted. On the other hand, setting a phase offset adds or subtracts a phase that is constant throughout the frequency range. Incidentally, data processing performed from this point on in the flowchart is applied to both the data array and the memory array.

Data Format/Group Delay

Complex data consisting of the real parts and the imaginary parts are converted into scalar data according to the data format of user's choice. Group delays are also calculated here.

Smoothing

By enabling the smoothing function, each point in a sweep measurement will be replaced by a moving average of several measurement points nearby. The number of points used in calculating a moving average is determined by the smoothing aperture set by the user. The smoothing aperture is defined by a percentage against the sweep span.

Formatted Data Array/Formatted Memory Array

All results from data processing are stored in the formatted data array and the formatted memory array. The marker functions are applied to these arrays. The limit test is applied to the formatted data array. The user is allowed to read/write data from/to these arrays.

Offset/Scale

Each set of data is processed so that traces can be drawn on the screen. Particular scaling depending on the data format is applied using the position of the reference line, the value of the reference line, and the scale/graticule settings.

Display

The results obtained after data processing are displayed on the screen as traces.

F

Replacing the 8753ES with the E5070B/E5071B

This chapter describes the information necessary to replace Agilent 8753ES with the Agilent E5070B/E5071B.

Important Functional Differences

This section describes the key differences between the Agilent 8753ES and Agilent E5070B/E5071B.

Channel and Trace Concepts

In the 8753ES, channels 1 and 2 are independent from each other and have auxiliary channels, channels 3 and 4, respectively. Channels 3 and 4 can be displayed as additions to channels 1 and 2, respectively. This allows up to four channels to be displayed for up to four traces on the screen simultaneously. Channels 1 and 3 and channels 2 and 4 are always coupled, while channels 1 and 2 are independent from each other. This enables you to specify different sweep conditions on each of channels 1 and 2. The E5070B/E5071B has four/nine/twelve/sixteen independent channels, each of which allows sweep conditions to be defined different from those on other channels. On the screen you can open up to sixteen windows, each of which allows up to sixteen traces to be defined.

Measurement Parameters

With the E5070B/E5071B, you can perform measurements of S parameter and absolute value of the power input into ports. In addition to these, the 8753ES supports measurement parameters such as A, B, R, A/R, B/R, A/B, etc.

Test Port Output Ranges

The 8753ES comes standard with test sets for two ports, while the E5070B/E5071B comes optionally with test sets for two ports (Options 213 and 214), three ports (Options 313 and 314), and four ports (Options 413 and 414). Furthermore, the 8753ES comes optionally with a 75 Ω test set (Option 075), while the E5070B/E5071B does not.

For more about the measurement frequency ranges of the 8753ES and E5070B/E5071B, see Table F-1.

Table F-1 Measurement Frequency Ranges

Function	8753ES	E5070B/E5071B
Measurement frequency range	30 kHz to 3 GHz (std.)	300 kHz to 3 GHz (E5070B)
	30 kHz to 6 GHz (Option 006)	300 kHz to 8.5 GHz (E5071B)

For more about the output power levels and output power ranges of the 8753ES and E5070B/E5071B, see Table F-2.

Table F-2 Test Port Output Power Levels

Function	8753ES	E5070B/E5071B
Output power levels	-85 dBm to 10 dBm (std.) -85 dBm to 8 dBm (Options 014 and 075)	-15 dBm to 0 dBm (Options 213, 313, and 413) -50 dBm to 0 dBm (Options 214, 314, and 414)
Output power ranges	-15 dBm to 10 dBm (std.) or -15 dBm to 8 dBm (Options 014 and 075), -25 dBm to 0 dBm, -35 dBm to -10 dBm, -45 dBm to -20 dBm, -55 dBm to -30 dBm, -65 dBm to -40 dBm, -75 dBm to -50 dBm, -85 dBm to -60 dBm	-15 dBm to 0 dBm only (Options 213, 313, and 413) -15 dBm to 10 dBm, -20 dBm to 5 dBm, -25 dBm to 0 dBm, -30 dBm to -5 dBm, -35 dBm to -10 dBm, -40 dBm to -15 dBm, -45 dBm to -20 dBm, -50 dBm to -25 dBm (Options 214, 314, and 414)

Sweep Function

The list (segment) sweep function enables you to perform measurements corresponding to two or more sweep conditions in one sweep operation and is supported both on the 8753ES and E5070B/E5071B. While the 8753ES allows only up to 30 segments per table to be defined, the E5070B/E5071B allows up to 201 segments to be defined. Furthermore, while two or more commands are needed to create a table using GPIB (SCPI) commands on the 8753ES, only one command does the same function on the E5070B/E5071B.

The 8753ES supports an IF bandwidth up to 6 kHz, but the E5070B/E5071B supports an IF bandwidth up to 100 kHz, enabling faster sweep operations than with the 8753ES.

While the 8753ES supports automatically selecting the output power range, the E5070B/E5071B supports only manual selection.

The 8753ES allows you to measure frequency conversion device such as a mixer; since it supports the frequency offset sweep. The E5070B/E5071B also supports this function when the option 008 is used.

Replacing the 8753ES with the E5070B/E5071B
Important Functional Differences

Calibration

The types of calibration kits supported by the 8753ES and E5070B/E5071B are shown in Table F-3.

Table F-3 Supported Calibration Kits

Type of calibration kit	8753ES	E5070B/E5071B
7 mm	85031B	85031B,85050C/D
3.5 mm	85033C/D/E	85033D/E, 85052D
N type	50 Ω: 85032B/E/F 75 Ω: 85036B/E	50 Ω: 85032B/F 75 Ω: 85036B/E
2.4 mm	85056/D	N/A
TRL 3.5 mm	85052C	85052C
7-16	N/A	85038A/F/M
Others	User-defined calibration kit	User-defined calibration kit

The 8753ES allows only one type of user-defined calibration kit to be saved in the internal memory. Up to 15 classes can be set up when defining calibration kits, including 12 classes (isolation included) to be used for full 2-port calibration and three calibration classes (THRU, reflect, and line/match for TRL*/LRM* calibration. A maximum of seven standards can be defined for each calibration class.

In contrast, the E5070B/E5071B allows 20 types of user-defined calibration kits to be saved in the internal memory, which include the ten calibration kits registered beforehand. When setting up calibration classes, OPEN, SHORT, and LOAD can be set up on each port and THRU between ports. Eight standards are allowed for each calibration class.

ECal

Both the 8753ES and E5070B/E5071B support ECal measurement. However, each supports slightly different functions. The 8753ES supports enhanced response calibration, 1-port calibration for S11 and S22, and full 2-port calibration. The E5070B/E5071B provides multi-port calibrations including enhanced response calibration, 1-port calibration for S11 and S22, full 2-port calibration, full 3-port calibration (with option 313/314/413/414) and full 4-port calibration (with option 413/414).

While the 8753ES allows a frequency array or module information to be read, but this function is not supported on the E5070B/E5071B.

Trigger System

The trigger system detects the signal for starting a measurement (trigger) and controls decisions on whether to measure or not measure.

On the 8753ES, the trigger state is available for the pair of a main channel and an auxiliary channel (two pairs: channels 1 and 3 and channels 2 and 4). For each pair, three states are available: Hold, Waiting for Trigger, and Measurement. When a trigger event occurs, one pair of channels in the Waiting for Trigger state are put into a sweep operation. If the other pair is also Waiting for Trigger, then the next trigger event puts it into sweep operation as well. When the sweep condition coupling channels is turned on, the Hold, Waiting for Trigger, and Measurement states are common to all channels. In this case, when a trigger event occurs in the Waiting for Trigger state, all channels are put into sweep operation. For example, when you set channel 1 and 2 to uncouple and sweep each channel, you need to set each channel to Hold state and make trigger events to each channel.

On the E5070B/E5071B, the trigger system involves states of the entire system and those of each of the channels. Since a trigger event is common to all channels, three system-wide states exist: Hold, Waiting for Trigger, and Measurement. On the other hand, two states exist for each channel: Idle and Startup. For a channel in an Idle state, measurement is not performed at all, while for a channel in Startup state, measurements are started in sequence after an event occurs. When all channels are in an Idle state, the E5070B/E5071B is in Hold state when viewed as an entire system. If even one Startup state channel exists, the E5070B/E5071B enters the Waiting for Trigger or Measurement state. Upon a transition from the Waiting for Trigger to the Measurement state, measurement is performed on channels put into Startup state starting with the channel with the smallest channel number.

While the 8753ES allows either High or Low input signals from the external trigger line to be selected, the E5070B/E5071B allows only Low input signals to be selected.

Replacing the 8753ES with the E5070B/E5071B Important Functional Differences

Data Flow

The data flow in the 8753ES is shown in Figure F-1 while the flow in the E5070B/E5071B is shown in Figure F-2. As described in “Reading/Writing Data” on page 741, the types of data you can read/write using the 8753ES differ from those you can read/write using the E5070B/E5071B.

Figure F-1

8753ES Data Flow

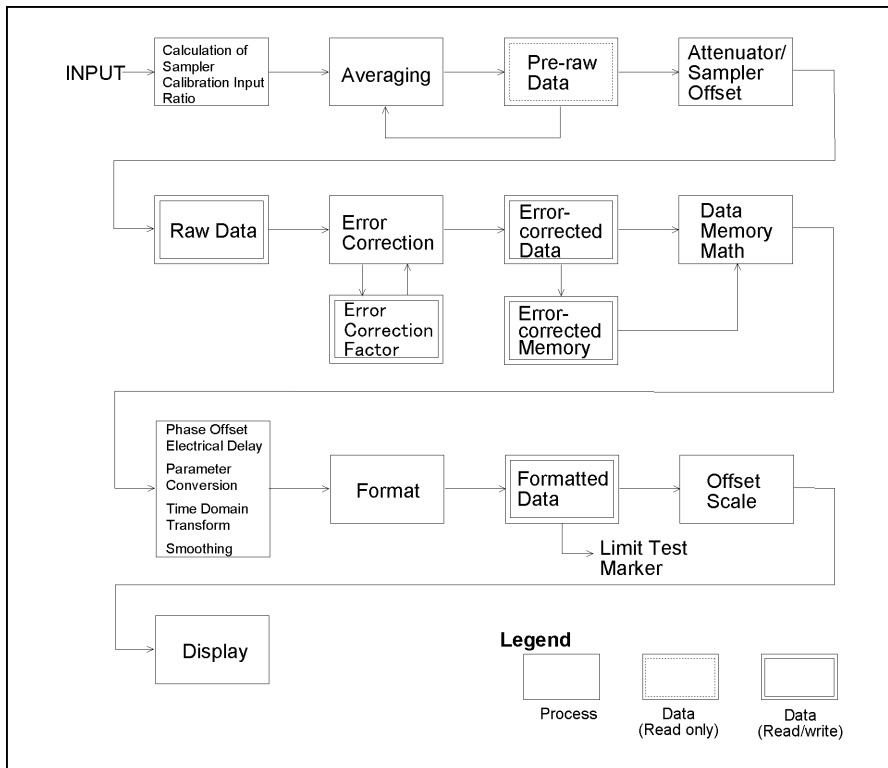
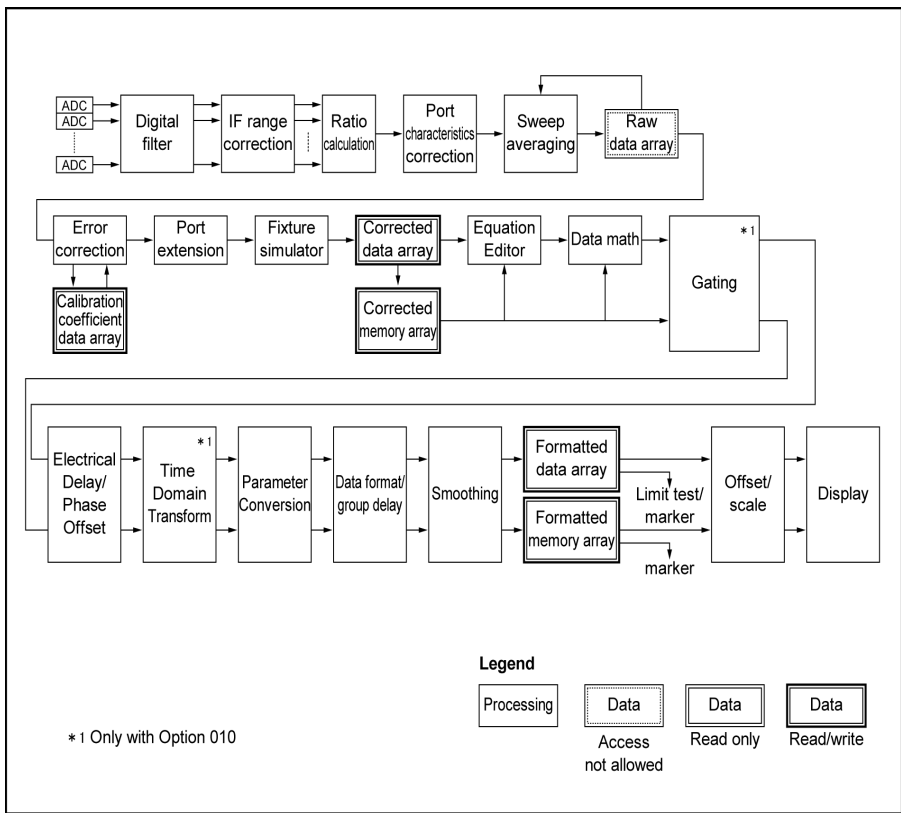

Figure F-2

E5070B/E5071B Data Flow



e5070bue10003

Reading/Writing Data

Types of data that can be handled by the 8753ES and E5070B/E5071B are listed in Table 3-4.

Table F-4 Reading/Writing Data

Function	8753ES	E5070B/E5071B
Data transfer format	Intra-device binary IEEE 32-bit floating point IEEE 64-bit floating point ASCII PC-DOS 32-bit floating point	IEEE 64-bit floating point ASCII
Reading/Writing data	Raw data array Calibration coefficient array (before interpolation) Corrected data array Formatted memory array Memory trace Calibration kit array data Power meter calibration coefficient array (before interpolation)	Formatted data array Formatted memory array Corrected data array Corrected memory array Power meter calibration coefficient array (after interpolation) Calibration coefficient data array (after interpolation)

F. Replacing the 8753ES with the E5070B/E5071B

Replacing the 8753ES with the E5070B/E5071B
Important Functional Differences

Table F-4 Reading/Writing Data

Function	8753ES	E5070B/E5071B
Reading data	Pre-raw data (in Take4 mode) Calibration coefficient array (after interpolation) Power meter calibration coefficient array (after interpolation) Entry area display All lists in list format	

Screen Display and Marker Functions

The 8753ES allows up to four channels to be displayed on the screen. Up to five markers can be displayed on each channel. Also, one of the displayed markers can be designated as the reference marker. Each channel also supports a fixed marker that can be established at a fixed position.

In contrast, the E5070B/E5071B enables you to have all sixteen channels displayed by opening up nine separate windows on the screen. Sixteen traces can be displayed for each channel, and up to nine markers can be displayed for each trace. In addition to the markers displayed, you can also designate one marker as the reference marker. The E5070B/E5071B, however, does not support fixed markers.

The 8753ES supports the Maximum, Minimum, Target value, and Bandwidth marker functions. The E5070B/E5071B supports all these in addition to a Peak Search function. Using this function, you can determine whether or not to search for a positive or negative peak. In addition, the 8753ES has an additional function to search for the maximum or minimum bandwidth. While the 8753ES allows a target value or search tracking to be established only on the active marker, the E5070B/E5071B allows a target value or search tracking to be established on all markers.

Math Operation Functions on Traces

On the 8753ES, each channel is provided with a memory trace. For this reason, math operations between the data trace and memory trace are supported: “Data / Memory” and “Data – Memory”. On the E5070B/E5071B, however, “Data × Memory” and “Data + Memory” are supported along with the division and subtraction operations described above.

The trace displays supported on the 8753ES are: “Data trace only”, “Memory trace only”, “Both memory trace and data trace”, and “Data math only”. The E5070B/E5071B supports these functions in addition to “Both data math and memory trace”.

Device Test Functions

The 8753ES supports the limit test, ripple test, and bandwidth test, while the E5070B/E5071B supports only the limit test. The 8753ES supports limit test, ripple test and bandwidth test. The E5070B/E5071B also supports these tests.

For the limit test on the 8753ES, a limit test table is provided for each channel with up to 18 segments are allowed in each table. In contrast, the E5070B/E5071B allows a limit test table to be defined for each trace and up to 100 segments to be defined per table.

The 8753ES supports the pass/fail result for each channel, segment or measurement point

along with the minimum/maximum measurement value for each segment as retrieved items in test results. On the other hand, the E5070B/E5071B supports pass/fail results, measurement value, and upper/lower limit values for each measurement point as well as pass/fail results of the active trace for each channel.

Analytical Functions

Although the 8753ES does not support the fixture simulator function, the E5070B/E5071B does. The fixture simulator supported by the E5070B/E5071B include the balanced-unbalanced transformation function for analyzing balanced devices, and the matching circuit function.

Replacing the 8753ES with the E5070B/E5071B

Important Functional Differences

Save/Recall

For storing data, the 8753ES is provided with an internal register, internal disk drive (floppy disk), and external disk drive (connected through the GPIB). In contrast, the E5070B/E5071B provides an internal hard disk drive, and an internal disk drive (floppy disk). While the 8753ES can save or recall the device setup, screen color settings, and test sequences, the E5070B/E5071B is able to save or recall the instrument setup, segment sweep table, and limit line table as well as VBA projects. The 8753ES saves display data in JPEG format while the E5070B/E5071B supports the Windows[®] Bitmap (BMP) and Portable Network Graphics (PNG) format.

Test Sequence Program

Although the 8753ES supports the test sequence program, the E5070B/E5071B provides an environment for developing VBA programs for automatic measurement.

Outputting to a Printer/Plotter

The 8753ES enables you to establish the print area covering an entire sheet or just a 1/4 sheet, and to define traces, the reference line, and colors of warning messages. In contrast, the E5070B/E5071B supports only full-sheet output, and an on/off setting for highlighting the entire screen in connection with color setup.

The 8753ES supports parallel ports, serial ports, and GPIB as printer ports, although the E5070B/E5071B supports only parallel- and USB-connected printers.

GPIB Interface

While the 8753ES uses pass control to pass the controller information to an external PC or instrument, the E5070B/E5071B does not support this function.

LAN Interface

Although the 8753ES does not support a LAN interface, support for LANs is standard on the E5070B/E5071B.

Other Functions

The 8753ES is provided with Take4 mode, mixer measurement function, and harmonics measurement function (Option 002), but the E5070B/E5071B is not provided with these functions.

Comparing Functions

Table F-5 Functions of the 8753ES vs. the E5070B/E5071B

Function		8753ES	E5070B/E5071B	
Measurement	Reset	Can be executed by using the front panel and the GPIB command.	Can be executed by using the front panel, the GPIB command, and telnet.	
	Channel	<p>Number of channels</p> <p>Coupling between channels</p> <p>Couple/Uncouple between channels 1 and 2 can be set up.</p>	<p>4/9/12/16 channels</p> <p>Channels are independent of each other.</p>	
	Trace	A trace for each channel	Each channel can accommodate up to 4/9/12/16 traces.	
	Measurement parameter	S-parameters, A, B, R, A/R, B/R, A/B, and analog bus	S-parameters (Mixed-mode S-parameters), Absolute value meas parameter	
	S-parameter conversion	Impedance (reflection and transmission), admittance (reflection and transmission), and 1/S	←	
	Display format (Data format)	log magnitude, linear magnitude, phase, group delay, Smith chart, polar format, SWR, real, imaginary	log magnitude, linear magnitude, phase, expanded phase, positive phase, group delay, Smith chart, polar format, SWR, real, imaginary	
Test port output	Number of ports	2 ports	2 ports (Opts. 213/214) 3 ports (Opts. 313/314) 4 ports (Opts. 413/414)	
	Frequency	30 kHz to 3 GHz (Std.) 30 kHz to 6 GHz (Opt. 006)	300 kHz to 3 GHz (E5070B) 300 kHz to 8.5 GHz (E5071B)	
	Power level	-85 to +10 dBm (Std.) -85 to +8 dBm (Opts. 014/075)	-15 to 10 dBm (Opts. 213, 313, 413) -50 to 10 dBm (Opts. 214, 314, 414)	
	Characteristic Impedance	50 Ω(Std.) 75 Ω(Opt. 075)	50 Ω	
	Coupled/Uncoupled power levels	You can define Couple/Uncouple between channels and between ports.	Traces are coupled on the same channel, not between channels.	
	Power slope function	Available	←	
	Turning the output On/Off	Allowed	←	
	Power range	Items to be set up	Per port and per channel	Per channel (Opts. 214/314/414) If the above options are not installed, the default range is -15 to 10 dBm.
		Automatic setting	On/Off setting capability	Manual setting
Setting range		Range setting with 10 dBm resolution is definable from between -15 and +10 dBm down to between -85 and -60 dBm.	Range setting with 5 dBm resolution is definable from between -15 and 10 dBm down to between -50 and -25 dBm	

F: Replacing the 8753ES
with the E5070B/E5071B

Replacing the 8753ES with the E5070B/E5071B
Comparing Functions

Table F-5 Functions of the 8753ES vs. the E5070B/E5071B

Function		8753ES	E5070B/E5071B		
Measurement (cont'd.)	Sweep conditions	Number of points (except for the list frequency sweep operation)	3, 11, 21, 26, 51, 101, 201, 401, 801, 1601	Arbitrary value from 2 to 1601 *1	
		Sweep type	linear sweep, log sweep, list sweep, power sweep, and CW time sweep	linear sweep, log sweep, segment sweep, and power sweep	
		List frequency sweep	Number of list tables	One for channels 1 and 3 and one for channels 2 and 4, two in total	One for each channel (16 in total)
			Number of segments per table	Up to 30	Up to 201
			Creation of a table using GPIB(SCPI) command	Creating a table using more than one command	Creating a table using a single command
			Number of points	1 to 1601 points per segment Up to 1601 points in total	2 to 1601 points per segment Up to 1601 points in total *1
			Stepped/swept mode	stepped mode and swept mod. Selectable only when list frequency sweep is performed	stepped mode, swept mode, fast stepped mode, and fast swept mode. Selectable also when list frequency sweep is not performed.
			Sweep of designated segments.	Allowed	Not allowed (Always sweeps all segments.)
			Sweep time	Automatic, Manual (definable from the shortest time to 24 hours)	Automatic, Manual (range of definable sweep depends on sweep condition)
		IF bandwidth	10 Hz, 30 Hz, 100 Hz, 300 Hz, 1 KHz, 3 kHz, 3.7 kHz, 6 kHz	10 Hz, 15 Hz, 20 Hz, 30 Hz, 40 Hz, 50 Hz, 70 Hz, 100 Hz, 150 Hz, 200 Hz, 300 Hz, 400 Hz, 500 Hz, 700 Hz, 1 kHz, 1.5 kHz, 2 kHz, 3 kHz, 4 kHz, 5 kHz, 7 kHz, 10 kHz, 15 kHz, 20 kHz, 30 kHz, 40 kHz, 50 kHz, 70 kHz, 100 kHz	
		Averaging	Can be set from 1 to 999.	Can be set from 1 to 999.	
		Smoothing		The smoothing aperture can be set from 0.05% to 20%.	The smoothing aperture can be set from 0.05% to 25%.
		Electrical delay	Transmission line	Compatible with coaxial cables and waveguides	Compatible with coaxial cables only
			Value	Any value from 0 to 10 seconds	Any value from -10 to +10 seconds
		Phase offset		Any value from -360° to +360°.	Any value from -360° to 360°.
Setting sweep conditions for Couple/Uncouple		Channels 1 and 3 and channels 2 and 4 are always coupled. Channels 1 and 2 can be set either at Couple or Uncouple.	Traces in the same channel are coupled; traces in different channels are not coupled.		
Trigger mode		Continuous, single, hold, specified number of sweeps	Continuous, single, hold		

Table F-5 Functions of the 8753ES vs. the E5070B/E5071B

Function		8753ES	E5070B/E5071B	
Measurement (cont'd.)	Trigger source	Internal, external (per sweep, per point), manual (per point)	Internal, external (per sweep), bus, manual (per sweep)	
	External trigger line	Can be set to High or Low	Low	
Display	Memory trace	Number	One per channel	
		Data math	Data / Memory Data – Memory	
		Display	Data trace only Memory trace only Simultaneous display of memory traces and data traces Data math only	
	Frequency display	On/Off setting is definable for all channels.	On/off setting is definable channel by channel.	
	Graph layout	Up to four graphs can be displayed.	Windows are assigned to each channel; up to sixteen windows can be displayed. Up to sixteen graphs can be displayed in each window.	
	Math between data traces	The results for channel 1/channel 2 can be displayed on the trace for channel 2.	Not available	
	Scale	Auto scale	Available	←
		Reference line	Both value and position can be specified.	←
		Scales per division	Definable	←
		Number of divisions	Fixed at 10	Can be set in increments of 2 from 4 to 30.
	Turning the softkey area On/Off	Available	←	
	List display	Available	Not available	
	List display of Instrument State	Available	Not available	
	Color settings	Available	←	
	Screen brightness setting	Available	Not available	
Turning the LCD On/Off	Available	←		
Turning the update On/Off	Always updates.	Available		

F: Replacing the 8753ES
with the E5070B/E5071B

Replacing the 8753ES with the E5070B/E5071B
Comparing Functions

Table F-5 Functions of the 8753ES vs. the E5070B/E5071B

Function		8753ES	E5070B/E5071B	
Calibration	Calibration kit	Available calibration kits: 7 mm: 85031B 3.5 mm: 85033C/D/E N type (50 Ω): 85032B/E/F N type (75 Ω): 85036B/E 2.4 mm: 85056A/D TRL 3.5 mm: 85052C User defined calibration kit	7 mm: 85031B, 85050C/D 3.5 mm: 85033D/E, 85052D N type (50 Ω): 85032B/F N type (75 Ω): 85036B/E 7-16 (50 Ω): 85038A/F/M Up to 20 user defined calibration kits can be registered.	
	Calibration type	Not more than two ports	Response calibration Response and isolation calibration Enhanced response calibration S11 1-port calibration S22 1-port calibration Full 2-port calibration TRL*/LRM* Calibration Receiver calibration Power meter calibration	Response calibration (OPEN,SHORT, THRU) Enhanced response calibration Full 1-port calibration Full 2-port calibration TRL/LRM Calibration TRL Calibration Unknown Thru The response calibration includes isolation measurement as an option.
		Not less than three ports	Not available	Full 3-port calibration (Opts. 313, 314, 413, and 414 only) Full 4-port calibration (Opts. 413 and 414 only) TRL/LRM Calibration TRL Calibration Unknown Thru
	Omission of the isolation measurement		Possible (Can be omitted by designating it using the softkeys on the front panel or sending a GPIB command from the front panel)	Possible (Isolation measurement is performed as an option accompanying a response calibration and 2-, 3-, and 4-port calibration.)
	Power meter calibration		Available	←
	Receiver calibration		Available	←
	Adapter removal		Available	←
	Velocity factor		Definable	←
	Characteristic impedance of the measurement system		Definable	Definable with fixture simulator
	Port extension		Definable for ports 1 and 2 and inputs A and B	Definable for each port per channel
Selection between chop sweep and alternate sweep		Can be changed over.	Chop sweep for traces in a channel and alternate sweep between channels	
Error correction		On/Off setting is definable.	←	
Interpolating the calibration coefficient		On/Off setting is definable.	Always On.	

Table F-5 Functions of the 8753ES vs. the E5070B/E5071B

Function		8753ES	E5070B/E5071B	
Calibration (cont'd.)	Defining the calibration kit	Calibration class	S11A (OPEN) S11B (SHORT) S11C (LOAD) S22A (OPEN) S22B (SHORT) S22C (LOAD) Forward Transmission Forward Match Reverse Transmission Reverse Match Response Response & Isolation TRL Thru TRL Reflect TRL Line/Match	OPEN SHORT LOAD THRU (OPEN, SHORT, and LOAD are set for each port; THRU is set between ports) TRL Thru TRL Reflect TRL Line/Match
		Class indication label	Editable	Not editable
		Number of standards that can be registered in calibration classes	Up to seven types	One type
		Type of standard	OPEN, SHORT, LOAD, and THRU Arbitrary Impedance	OPENOPEN, SHORT, LOAD, and THRU Arbitrary Impedance, None
	Standard parameters	Common to standards	Offset delay Offset loss Offset characteristic impedance Frequency range Offset type (coaxial, waveguide)	←
		Unique to OPEN	C0, C1, C2, C3	←
		Unique to SHORT	Not available	L0, L1, L2, L3
		Unique to LOAD	Type of standard (fixed, sliding, offset)	Not available (the type of standard is treated as fixed load.)
		Unique to THRU	Not available	←
		Arbitrary Impedance	Type of standard (fixed, sliding) Arbitrary Impedance	Arbitrary Impedance
	Standard label		Editable	←
	ECal	Type of calibration	Enhanced response calibration S11 1-port calibration S22 1-port calibration Full 2-port calibration	Enhanced response calibration Response (thru) calibration Full 1-port calibration Full 2-port calibration Full 3-port calibration (Opts. 313/314/413/414) Full 4-port calibration (Opts. 413/414)
		Omission of isolation	Allowed	←
		Manual THRU measurement	Allowed	Not allowed
		Reading the frequency array	Allowed	Not allowed
Reading the module information		Allowed	Not allowed	

F. Replacing the 8753ES
with the E5070B/E5071B

Replacing the 8753ES with the E5070B/E5071B
Comparing Functions

Table F-5 Functions of the 8753ES vs. the E5070B/E5071B

Function		8753ES	E5070B/E5071B
Reading/Writing data	Transfer format	Intra-device binary IEEE 32-bit floating point IEEE 64-bit floating point ASCII PC-DOS 32-bit floating point	IEEE 32-bit floating point IEEE 64-bit floating point ASCII PC-DOS 32-bit floating point
	Object to be read/written	Raw data array Calibration coefficient data array (before interpolating) Corrected data array Formatted memory array Memory trace Calibration kit array data Power meter calibration coefficient array (before interpolating)	Calibration coefficient data array (after interpolating) Corrected data array Corrected memory array Formatted data array Formatted memory array Power meter calibration coefficient array (after interpolating)
	Object to be read only	Pre-raw data (in Take4 mode) Calibration coefficient array (after interpolating) Power meter calibration coefficient array (after interpolating)	
	Reading data for a designated point or scope	Allowed only for data traces	Not allowed
Marker	Number of markers	Up to five markers per channel	Nine markers per tracer (exclude reference marker)
	Active marker	One marker per channel	One marker per trace
	Delta marker (Reference marker)	Designates the marker displayed as the reference marker.	You can designate the reference marker independently from the markers displayed.
	Marker coupling	Setting of Couple/Uncouple definable	Setting of Couple/Uncouple definable (coupling available only between markers on the same channel)
	Marker move mode	Continuous/discrete (definable channel by channel)	Continuous/discrete (definable trace by trace)
	Fixed marker	One marker definable per channel	Not available
	Marker value display	On/Off setting for the marker value display definable per channel	All marker values for active traces are displayed on each channel.* ² Display/No Display setting for the marker table displaying all marker values definable

Table F-5 Functions of the 8753ES vs. the E5070B/E5071B

Function			8753ES	E5070B/E5071B
Markers (cont'd.)	Marker search	Search function	Maximum, minimum, target value, bandwidth	Maximum, minimum, target value, peak
		Object of search	Active marker	Arbitrary marker (during remote control) Active marker (when manipulating the front panel)
		Parameters for bandwidth search	Bandwidth, bandwidth center frequency Q factor, loss	Bandwidth, bandwidth center frequency Upper and lower frequency of the bandwidth Q factor, loss
		Target value	Definable for an active marker	Definable for each marker
		Target transition type	Not definable	Setting of Positive/Negative transition definable (per marker)
		Search tracking	On/Off setting definable for the active marker (Markers other than the active marker are always turned off.)	On/Off setting definable for each marker
		Marker reading set at a parameter	Values of the start, stop, center, span, CW frequency, and reference line in the sweep range	Values of the start, stop, center, span, and reference line in the sweep range
	Reading the marker value (for remote control)		Possible for the active marker	Possible for any marker
Device test	Limit test	Limit test table	One per channel Number of segments: Up to 18 per table	One per trace Number of segments: Up to 100 per table
		Offset	Definable	Not definable
		Creating a table by using the GPIB command	Create a table by using two or more commands	Create a table by using one command
		Reading the results	Per channel, Per segment Pass/fail at each point, Number of points per segment that failed the maximum/minimum, Stimulus value at a failed point	Pass/Fail of the active trace on each channel Number of failed points Stimulus value at a failed point
	Ripple test		Available	Not available
	Bandwidth test		Available	Not available (Marker search function can be used for the bandwidth search.)
Analysis	Fixture simulator		Not available	Available

Replacing the 8753ES with the E5070B/E5071B
Comparing Functions

Table F-5 Functions of the 8753ES vs. the E5070B/E5071B

Function		8753ES	E5070B/E5071B
Status report	Register types	Status byte register Service request enable register Standard event status register Standard event status register B and enable register	Status byte register Service request validation register Standard event status register Operation status register and validation register Questionable status register and validation register
	For limit test	Included in the standard event status register B and validation register	Questionable limit status register Questionable limit channel status register Questionable limit extra channel status register Questionable limit channel extra status register Questionable ripple limit status register Questionable ripple limit channel status register Questionable ripple limit extra channel status register Questionable ripple limit channel extra status register Questionable bandwidth limit status register Questionable bandwidth limit channel status register Questionable bandwidth limit extra channel status register Questionable bandwidth limit channel extra status register
Save/Recall	Storage	Internal registers Internal disk (floppy disk) External disk (connected through GPIB)	Internal hard disk Floppy disk
	Storage initialization	Possible	Available with mouse
	Save only	LCD screen image	Formatted data array LCD screen image
	Object to be saved/recalled	Instrument State (You can simultaneously save formatted data array for the active trace, raw data array, corrected data array, and LCD images.) Color settings Test sequence	Instrument State (You can simultaneously save formatted data array for the active trace and calibration data.) Segment sweep table Limit line table VBA project
	File formats	Binary form, ASCII form	Binary form
	Format for saving the screen display	JPEG format	Windows® Bitmap format, PNG format
	File manipulation	Reading file information Deleting a file	Reading file information Deleting a file or folder Creating a folder Copying a file

Table F-5 Functions of the 8753ES vs. the E5070B/E5071B

Function		8753ES	E5070B/E5071B	
Macros	Creating macros	Uses a test sequence.	Uses VBA.	
	Automatic execution	Will execute if "AUTO" is given as the name of the sequence 6.	Only auto loading is possible.	
System	Self-test	Can be executed by using the front panel and SCPI commands.	Can be executed by using the front panel.	
	Internal clock	Available	Available	
	Beep sound	On/Off setting definable for completion of actions, warnings, and limit test failures	On/Off setting definable for completion of actions and warnings	
	Measuring instrument mode	Can be selected from a standard network analyzer, external signal source (automatic), external signal source (manual), and tuned receiver.	Always a network analyzer	
Printer / Plotter output	Print range	Entire sheet, 1/4 of a sheet	Entire sheet	
	Color settings	Settings definable for the colors of a trace, reference line, text, and warning messages	Highlighting/No highlighting of all elements	
	Line settings	Possible	Always a solid line.	
	Printer port	Parallel port Serial port GPIB	Parallel port USB	
Others	Time domain transformation	Available	←	
	Take4 mode	Available	Not available	
	Mixer measurement function	Available	Not available	
	Harmonics measurement	Available (Opt. 002)	Not available	
	Key manipulation-related GPIB command	GPIB commands that perform the same processing as do the front panel key and softkey manipulation.	Not available	
	LAN	interface	Not available	10 Base-T and 100 Base-TX
		protocol	Not available	TCP/IP
		function	Not available	Telnet, SICL-LAN
	GPIB	Debug mode	Can be turned On/Off	Not available
		pass control	Available	Not available
		GPIB address setup	The addresses of the main body, controller, external disk, LO control, power meter, printer, and plotter can be specified by using the GPIB command and from the front panel.	The address of the main body can be specified from the front panel. The addresses of the power meter can be specified by using the GPIB command and from the front panel.
		Parallel port	Can be used as a printer or GPIO connector.	For printer use

*1. The number of measurement points can be set to 20001 only when the channel/trace is set to **1 Ch / 4 Tr 20001 points**.

*2. All the marker values for non-active traces can also be displayed on each channel.

Replacing the 8753ES with the E5070B/E5071B
Comparing Functions

Symbols

- .bmp
 - Saving the screen image, 366
- .csv
 - Saving/Recalling files, 360
- CSV file
 - Saving trace data, 360
- .sta
 - Saving/Recalling files, 352

Numerics

- 1/S(Trace status), 48
- 1-Port Calibration, 113
 - procedure, 114
 - Using a 2-Port ECal Module, 127
- 4-port ECal, 135
- 4-port network embedding/de-embedding, 290

A

- Absolute measurement, 326
 - Setting absolute measurement parameters, 327
- Absolute Value Measurement, 326
- Accessories, 563
- ACTIVE CH/TRACE Block, 32
- Active Channel
 - selecting, 66
- Active Channel Trigger, 250
- Active Trace
 - selecting, 66
- Adapter Insertion, 167, 169
- Adapter Removal, 167
- AdapterCharacterization.vba
 - Adapter Characterization, 160
 - Calibration between Ports of Different Connector Types, 155
- Adaptors
 - Accessories, 573
- ADC
 - Data Processing, 730
- Admittance, 275
- Allocate traces, 65
- Analysis Menu
 - Softkey Functions, 647
- Analyzer Environment
 - specification, 551
- assistance, 5
- auto port extension, 404
- Auto Port Extensions, 404
- Auto Recall function
 - Settings, 355
- Auto Scale
 - settings, 85
- Automatic Sweep Time Mode
 - switching, 79
- Average Menu
 - Softkey Functions, 662

Averaging

- Sweep-to-sweep
 - Equation, 395
- averaging trigger, 249
- Avoid spurious
 - Frequency-offset measurement, 320

B

- Balance measurement topology property, 299
- Balanced mixer, 230
- balanced port
 - function, 284
- Balance-Unbalance Conversion
 - setting, 298
- Balance-unbalance conversion function, 293
- Bandwidth Search, 270
- Bandwidth test, 742
 - Concept, 390
 - Display result, 391
 - Max bandwidth, 392
 - Min bandwidth, 392
 - ON/OFF, 392
 - Set up, 392
 - threshold, 392
- Beeper
 - setting, 445
- Bitmap file
 - Screen image, 366

C

- Calibration
 - Types and Characteristics, 99
 - Using the 4-port ECal module, 135
- Calibration between Ports of Different Connector Types, 155
- Calibration Coefficient Data Array
 - Data Processing, 731
- Calibration kit
 - Accessories, 565
 - Changing the calibration kit definition, 181
 - Selecting calibration kit, 105
- Calibration Menu
 - Softkey Functions, 663
- Calibration property, 103
- Capture, 370
- certification, 5
- Changing Frequency Data, 321
- Channel Window, 46
- Channel window
 - layout, 62
- Characteristic impedance, 69
- Characterization, 177
- Characterization Info, 177
- Checking calibration status, 102
- Cleaning, 580
- Clipboard, 370
- Color, 91
- Compatibility of files, 352

-
- Confidence check, 179
 - Configuring ripple limit, 385
 - Connector Repeatability Errors, 94
 - Connectors
 - Maintenance, 580
 - Conversion, 275
 - Conversion Loss
 - Frequency-offset measurement, 323
 - Conversion Loss Measurement, 323, 327, 328
 - Corrected Data Array
 - Data Processing, 732
 - Corrected Memory Array
 - Data Processing, 732
 - Corrected System Performance
 - specification, 535
 - CSV file
 - Limit table, 379
 - D**
 - D*M(Trace status), 48
 - D+M(Trace status), 48
 - D/M(Trace status), 48
 - Data Entry Bar, 40
 - Data Format
 - Data Processing, 732
 - selecting, 84
 - Data Math
 - Data Processing, 732
 - Performing, 273
 - Data Transfer Time
 - specification, 557
 - Date and Time
 - Display ON/OFF, 430
 - setting, 429
 - Date when firmware was construct, 447
 - DC Loss, 402
 - DC loss, 402
 - de-embedding
 - 4-port network, 290
 - Default Values, 629
 - Define calibration kit, 587
 - Definition
 - Calibration kit, 181
 - Del(Trace status), 48
 - Deviation from a Linear Phase
 - Measuring Examples, 505
 - Differential matching circuit embedding, 284
 - Differential Port
 - Determining the Characteristics that Result from Adding a Matching Circuit, 303
 - Reference Impedance Conversion, 300
 - Differential port impedance conversion, 284
 - Digital Filter
 - Data Processing, 730
 - Dimensions
 - specification, 551
 - Directivity Errors, 96
 - Display
 - Data Processing, 733
 - Display Menu
 - Softkey Functions, 688
 - Display mode, 91
 - D-M(Trace status), 48
 - documentation map, 7
 - Documentation Warranty, 5
 - Drift Errors, 94
 - Duplexer
 - Measuring Examples, 493
 - Dynamic Range
 - Expanding, 394
 - E**
 - E5091A
 - assigning test port, 477
 - connection, 474
 - control line, 480
 - displaying property, 479
 - selecting ID, 476
 - Selecting Option, 477
 - ECal, 127
 - ECal(4-port), 135
 - EcalCharacterization.vba, 171
 - Electrical Delay
 - Data Processing, 732
 - Electrical delay, 398
 - Electronic Calibration, 127
 - embedding
 - 4-port network, 290
 - EMC
 - specification, 548
 - Enhanced Response Calibration, 115
 - procedure, 116
 - ENTRY Block, 36
 - Equation Editor, 277
 - equation label, 279
 - Error Correction
 - Data Processing, 731
 - Error correction status, 102
 - Error Messages, 613
 - Ethernet Port, 55
 - exclusive remedies, 5
 - Executing print, 372
 - Ext Trig, 55
 - External Monitor Output Terminal, 55
 - External PC
 - Connecting via LAN, 440
 - External Reference Signal Input Connector, 56
 - External signal source
 - Control procedure, 320
 - External signal source control, 316
 - Frequency setting, 318
 - GPIB address setting, 317
 - Power level setting, 319
 - Setting external signal source, 316

external trigger delay time, 247
 External Trigger Input Connector, 55

F

F1(Trace status), 48
 F2(Trace status), 48
 F3(Trace status), 48
 F4(Trace status), 48
 Fail Sign, 375
 Fan, 55
 File
 Copy, 356
 Delete, 356
 Rename a file, 356
 Firmware Revision, 447
 Manual Changes, 584
 Fixture Simulator
 Data Processing, 731
 Example, 306
 overview, 282
 Fixture simulator, 281
 Floppy Disk Drive, 34
 Format Menu
 Softkey Functions, 692
 Formatted Data Array
 Data Processing, 732
 Formatted Memory Array
 Data Processing, 732
 Frequency Base Display, 417
 Frequency data
 X-Axis, 321
 Frequency Offset Mode, 311
 Frequency Range
 settings, 70
 Frequency-offset measurement, 311
 Avoid spurious, 320
 Conversion Loss, 323
 Frequency data, 321
 Harmonic distortion, 326
 Measurement of mixers, 313
 Overview, 312
 Setting external signal source, 316
 Setting frequency-offset, 313
 Front Keys
 Locking, 444
 front panel, 30
 Front Panel Information
 specification, 548
 Full 2-Port Calibration, 118
 procedure, 119
 Using the 2-Port ECal Module, 128
 full 2-port calibration
 using 2-port ECal, 131
 Full 3-Port Calibration, 121
 procedure, 122
 Using the 2-Port ECal Module, 132
 Full 4-Port Calibration, 124

procedure, 125
 Using the 2-Port ECal Module, 132

G

Gat(Trace status), 48
 Gating, 345
 General Information
 specification, 547
 GPIB
 setting, 426
 GPIB address
 Power meter, 317, 321
 GPIB address setting
 External signal source, 317
 GP-IB Cables
 Accessories, 574
 GPIB Connector, 55
 Graph layout, 65
 Graticule Labels
 turning off the display, 88
 Group Delay
 Data Processing, 732

H

Handler I/O Port, 55
 Harmonic distortion, 326
 Harmonic distortion measurement, 328
 Harmonics measurement function, 744
 Hiding Frequency Information, 89
 Hiding Softkey's Frequency Information, 89
 High Stability Frequency Reference Output Connector, 56
 High Temperature Environments
 Reduce Measurement Error, 409
 history,
 manual printing, 2

I

IF Range Correction
 Data Processing, 731
 Impedance, 275
 Initial Source Port Control function, 471
 Initializing, 60
 Input from the front panel, 356
 Installation and Quick Start Guide, 7
 INSTR STATE Block, 37
 Instrument Noise Errors, 94
 Instrument Status Bar, 44
 Internal Clock
 setting, 429
 Internal Data
 Saving and Recalling, 352
 Internal Reference Signal Output Connector, 57
 Invert color, 91
 IP Address, 447
 Isolation errors, 96

K

Keyboard
 Locking, 444
Keyboard Port, 57

L

Layout of channel windows, 62
LCD Screen, 31
LCD Screen Backlight
 Turning off, 446
Limit Line
 Defining, 376
Limit test
 Concept, 374
 Displaying judgement result, 375
 Limit line
 ON/OFF, 380
 Limit Line Offset, 381
 Amplitude Offset, 381
 Marker Amp. Ofs., 381
 Stimulus Offset, 381
 Limit table
 Adding/Deleting segments, 376
 Begin Response, 377
 Begin Stimulus, 377
 Call, 376
 Clear, 376
 Creating/Editing, 376
 End Response, 377
 End Stimulus, 377
 Initializing, 382
 MAX/MIN/OFF, 377
 Save to a file, 376
 Type, 377
 ON/OFF, 380
Line Switch, 55
Load match errors, 97
Loss, 402
loss value, 402
low-latency external trigger mode, 246
LRL, 585
LRM, 585

M

M(Trace status), 48
MAC Address, 447
Macro Setup Menu
 Softkey Functions, 693
manual changes, 583
manual printing history, 2
Manual Sweep Time Mode
 settings, 79
Marker
 Listing All the Marker Values, 259
 Reading Only the Actual Measurement Point, 257
 Reading the Relative Value, 256

 Reading the Value Interpolated Between Measurement Points, 257
 Reading Values on the Trace, 253
 Search for the maximum, 265
 Search for the minimum, 265
 Search for the Target Value, 266
 Search Tracking, 264
 Searching for the Peak, 268
 Setting Up Markers for Coupled Operations Between Traces, 258
 Setting Up Markers for Each Trace, 258
Marker Function Menu
 Softkey Functions, 697
Marker Menu
 Softkey Functions, 695
Marker Response Value
 setting up, 253
Marker Search Menu
 Softkey Functions, 698
Matching Circuit
 Determining Characteristics, 287
Matching circuit embedding, 283
Maximum search, 265
Measurement capabilities
 specification, 558
Measurement Menu
 Softkey Functions, 701
Measurement Menu (Balance Measurement, SE-Bal)
 Softkey Functions, 703
Measurement Menu (Balanced Measurement, Bal-Bal)
 Softkey Functions, 704
Measurement Menu (Balanced Measurement, SE-SE-Bal)
 Softkey Functions, 706
Measurement of Mixer, 313
Measurement Parameters
 selecting, 80
Measurement Throughput
 Improving, 410
Measurement Throughput Summary
 specification, 555
Menu Bar, 40
Minimum search, 265
Mixer measurement function, 744
MKR/ANALYSIS Block, 38
Mouse
 Locking, 444
 Setup Step, 431
Mouse Port, 58

N

NAVIGATION Block, 35
Network
 Configuring, 434
 Network De-embedding
 setting, 285
 Network de-embedding, 283
Nominal

-
- Definitions, 534
 - Number of channels, 62
 - Number of Points
 - settings, 78
- O**
- Offset
 - Data Processing, 732
 - Open dialog box, 357
 - OPEN/SHORT Response Calibration, 107
 - procedure, 107
 - Operational Manual, 7
 - Option, 447
 - Order Base Display, 417
 - Overview of Frequency Offset Measurement, 312
- P**
- Parameter conversion, 275
 - partial re-calibration, 151
 - Peak search, 268
 - Phase Measurements
 - Improving the Accuracy, 398
 - Phase Offset
 - Data Processing, 732
 - Phase offset, 400
 - Point Trigger
 - function, 245
 - Polar Format, 82
 - manual scale adjustment, 87
 - Port Characteristics Correction
 - Data Processing, 731
 - Port Extension
 - Data Processing, 731
 - port extension, 401
 - Port Extensions, 401
 - Port Impedance
 - Converting, 286
 - Port reference impedance conversion, 283
 - Power Cable Receptacle, 56
 - power calibration
 - tolerance, 218
 - Power Level
 - Auto Power Level set function, 74
 - Auto Power Range set function, 74
 - manual power range settings, 77
 - settings, 74
 - Power meter
 - GPIO address setting, 317, 321
 - preset
 - confirmation button, 449
 - preset function, 449
 - Preset Menu
 - Softkey Functions, 708
 - Printer
 - Available printers, 369
 - Printer Parallel Port, 57
 - Printers Folder dialog box, 372
 - Printing Preferences dialog box, 371
 - Procedures for controlling external signal source, 320
 - Programming Manual, 7
- Q**
- Quick Start Guide, 7
- R**
- Random Errors, 94
 - Ratio Calculation
 - Data Processing, 731
 - Raw Data Array
 - Data Processing, 731
 - Rear Panel, 54
 - Rear Panel Information
 - specification, 548
 - Recalling a file
 - Compatibility, 352
 - Receiver
 - System Description, 729
 - Receiver Calibration, 220
 - Receiver calibration, 748
 - Rectangular Display Format
 - manual scale adjustment, 85
 - Rectangular Display Formats, 81
 - Ref In, 56
 - Ref Out, 57
 - Ref Oven, 56
 - Reference Line
 - settings, 87
 - Reflection Test, 107, 113
 - procedure, 107, 114
 - Reflection tracking errors, 97
 - Remote Control, 439
 - Removable Hard Disk, 577
 - purchase, 577
 - Replacement of Parts, 581
 - Reserved Port, 57
 - RESPONSE Block, 33
 - Ripple Limit Table
 - Initializing, 389
 - Saving and Recalling, 387
 - Ripple test, 742
 - Concept, 383
 - Display result, 384, 388
 - Display ripple limit line, 388
 - ON/OFF, 388
 - RO(Trace status), 48
 - RS(Trace status), 48
 - RT(Trace status), 48
- S**
- Safe mode, 31
 - Safety
 - specification, 548
 - safety

- symbols, 4
- safety summary, 3
- Sample Program, 8
- Save
 - Limit Table, 387
- Save as dialog box, 356
- Save/Recall Menu
 - Softkey Functions, 709
- SaveToTouchstone.vba, 361
- SaveTouchstone data file
 - Trace data SaveToTouchstone.vba, 595
- Saving a file
 - Compatibility, 352
- Saving a user preset, 450
- Saving/Recalling files
 - All, 352
 - State & Cal, 352
 - State & Trace, 352
 - State Only, 352
- SAW Bandpass Filter
 - Measuring Examples, 486
- Scalar Mixer Calibration, 233
- Scalar-Mixer Calibration, 233
 - Operating procedure (calibration kit), 235
 - Operating procedure (ECal), 238
- Scale
 - Data Processing, 732
- Scale Menu
 - Softkey Functions, 713
- Scales
 - settings, 85
- Screen Area, 40
- Screen Image
 - output, 369
 - Saving to a File, 366
- Search Tracking, 264
- section titles, 581, 728
- Segment Display
 - Setting Up, 422
- Segment Sweep
 - Concept, 415
 - Executing, 422
- Segment Table
 - Creating, 419
 - Saving in CSV Format, 423
- Serial Number, 447
 - Checking, 447
 - Manual Changes, 584
- Serial Number Plate, 57
- Serial number plate, 584
- Setting External Signal Source, 316
- Setting External Signal Source Power Level, 319
- Setting the user preset, 449
- Signal Separator
 - System Description, 729
- simplified calibration
 - simplified 3/4-port TRL calibration, 149
 - simplified full 3/4-port calibration, 148
- Simplified full 3/4 port calibration, 102
- single-ended port
 - function, 283
- Smith Chart
 - manual scale adjustment, 87
- Smith Chart Format, 83
- Smo(Trace status), 48
- Smoothing
 - Data Processing, 732
- Softkey Menu Bar, 42
- Source match errors, 97
- Source Switcher
 - System Description, 729
- S-Parameters
 - settings, 80
- Specification
 - Definitions, 534
- Specifications, 533
- Spurious Avoidance Function, 320
- Standby Switch, 31
- Stimulus
 - settings, 70
- STIMULUS Block, 34
- Stimulus Menu
 - Softkey Functions, 714
- sub class, 203, 204, 205
 - definition, 203
- Sweep Averaging
 - Data Processing, 731
- Sweep Delay Time
 - Segment Sweep, 417
- Sweep Setup Menu
 - Softkey Functions, 715
- Sweep Time
 - Segment Sweep, 417
 - settings, 78
- Sweep-to-sweep averaging
 - Equation, 395
- Switch Repeatability Errors, 94
- Synthesized Source
 - System Description, 728
- System Accessories, 574
- System Bandwidths
 - specification, 547
- System Description, 728
- System Dynamic Range
 - specification, 535
- System Error Correction
 - Turning Off, 414
- System Menu
 - Softkey Functions, 718
- System Racks and Cases
 - Accessories, 574
- System Recovery
 - How to Execute, 451
- System Z0, 69

Systematic Errors, 95

T

Take4 mode, 744
 Target search, 266
 Test Port, 38
 Test Port Cables
 Accessories, 564
 Test Port Input (Dynamic Accuracy)
 specification, 545
 Test Port Input (Group Delay)
 specification, 546
 Test Port Input (Stability)
 specification, 545
 Test Port Input (Trace Noise)
 specification, 544
 Test Port Input Levels
 specification, 543
 Test Port Output Frequency
 specification, 541
 Test Port Output Power
 specification, 541
 Test Port Output Signal Purity
 specification, 541
 Test Ports
 Maintenance, 580
 Test sequence, 744
 THRU Response Calibration, 110
 procedure, 110
 Time domain, 331
 Gating, 345
 Overview, 332
 Transform, 334
 Touch Screen
 Calibration, 470
 Touchstone
 Saving/Recalling files, 361
 Trace
 Comparing, 273
 Determining the Bandwidth, 270
 Determining the Mean, Standard Deviation, and p-p, 272
 Trace Data
 Saving, 360
 Trace Display
 maximizing, 88
 Trace layout, 64
 Trace Noise
 Reducing, 396
 Trace Status Area, 48
 Trace status area
 Status of the error correction for each trace, 102
 Transform, 334
 Transmission Test, 110
 procedure, 110
 Transmission tracking errors, 98
 Trigger
 setting, 242

Trigger Menu
 Softkey Functions, 725
 Trigger Modes
 function, 243
 Trigger Scope, 250
 Trigger Source
 function, 243
 TRL, 585
 TRL 2-port calibration, 137
 TRL 3-port calibration, 140
 TRL 4-port calibration, 144
 TRL/LRM Calibration
 Multiport TRL/LRM Calibration, 591
 Performing multiport TRL/LRM calibration, 592
 TRL/LRM calibration, 585
 Execute 2 portTRL/LRMcalibration, 589
 LRL calibration, 585
 TRL/LRM calibration 2port TRL/LRM calibration, 587
 Troubleshooting
 during Operation, 609
 during Startup, 608
 External Devices, 612
 typeface conventions, 6
 Typical
 Definitions, 534
 Typical Cycle Time for Measurement Completion
 specification, 555

U

Unbalanced and Balanced Bandpass Filter
 Measuring Examples, 509
 unbalanced port
 function, 283
 Uncorrected System Performance
 specification, 540
 Unknown Thru Calibration, 130, 153
 Update Off, 414
 USB (USBTMC) Interface Port, 58
 USB ID, 447
 USB Mass Storage Device, 443
 USB Port, 39, 57
 user characterized ECal, 171

V

Vector Mixer Calibration, 223
 Vector-Mixer Calibration, 223
 Balanced mixer characterization, 230
 Measured mixer, 224
 Mixer characterization, 225
 Overview, 223
 Velocity factor, 400
 Video, 55
 Virtual Network Computing, 439
 VNC, 439

W

Warning Message, 626

Web Server, 439

Window

 labeling, 89

Window Display

 maximizing, 88

Window Displays

 settings, 88

X

X-Axis

 Frequency data, 321

Y

Yr(Trace status), 48

Yt(Trace status), 48

Z

Z0, 69

Zr(Trace status), 48

Zt(Trace status), 48

REGIONAL SALES AND SUPPORT OFFICES

For more information about Agilent Technologies test and measurement products, applications, services, and for a current sales office listing, visit our web site: <http://www.agilent.com/find/tmdir>. You can also contact one of the following centers and ask for a test and measurement sales representative. 21/01/2004

United States:

Test and Measurement Call Center
(tel) 1 800 452-4844
(fax) 1 888 900-8921

Australia/New Zealand:

(tel) (61 3) 9210-5555 (Australia)
(fax) (61 3) 9210-5899
(tel) (64 4) 939-0636 (New Zealand)
(fax) (64 4) 972-5364

Canada:

Test and Measurement Call Center
(tel) 1 877 894-4414
(fax) 1 888 900-8921

Asia Pacific:

(tel) (65) 6375-8100
(fax) (65) 6836-0252
Email: tm_asia@agilent.com

China:

(tel) 800 810-0189
(fax) 800 820-2816

Europe:

(tel) (31 20) 547-2323
(fax) (31 20) 547-2390

Japan:

Call Center
(tel) 0120 421-345
(tel) (81) 426 56-7832
(fax) (81) 426 56-7840

Korea:

(tel) (82 2) 2004-5004
(fax) (82 2) 2004-5115

Latin America:

(tel) (305) 269-7500
(fax) (305) 269-7599

Taiwan:

(tel) 0800 047 866
(fax) 0800 286 331