

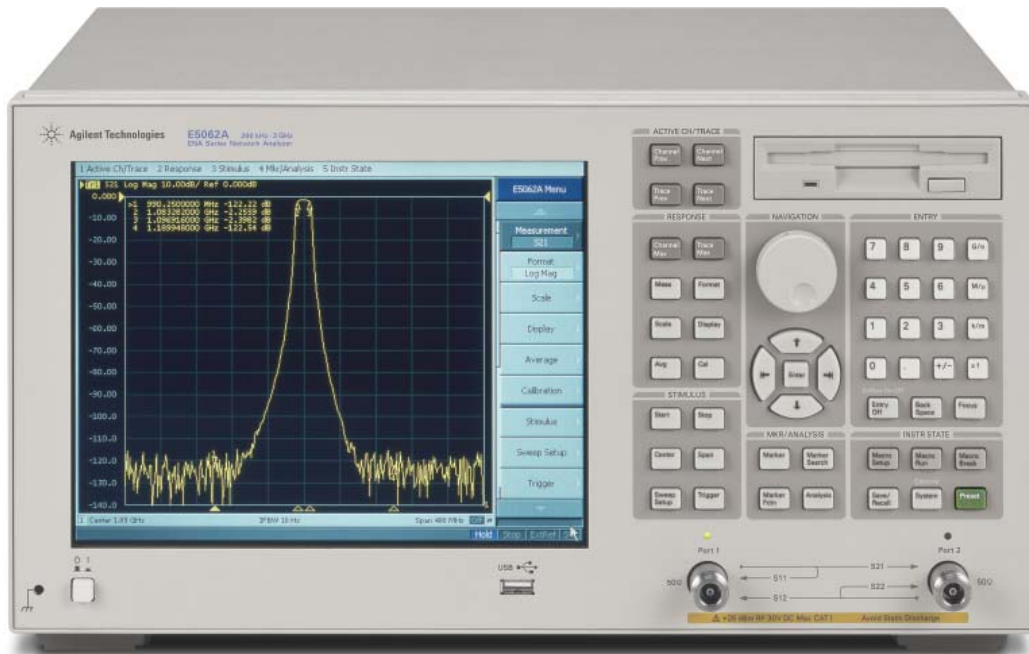

# Agilent ENA-L RF Network Analyzers

E5061A, 300 kHz to 1.5 GHz  
E5062A, 300 kHz to 3 GHz

Data Sheet



## Definitions

All specifications apply over a 23 °C ±5 °C range (unless otherwise stated) and 90 minutes after the instrument has been turned on.

### **Specification (spec.):**

Warranted performance. Specifications include guardbands to account for the expected statistical performance distribution, measurement uncertainties, and changes in performance due to environmental conditions.

Supplemental information is intended to provide information that is helpful for using the instrument but that is not guaranteed by the product warranty.

### **Typical (typ.):**

Describes performance that will be met by a minimum of 80% of all products. It is not guaranteed by the product warranty.

### **Supplemental performance data (SPD):**

Represents the value of a parameter that is most likely to occur; the expected mean or average. It is not guaranteed by the product warranty.

### **General characteristics:**

A general, descriptive term that does not imply a level of performance.

## Corrected system performance

The specifications in this section apply for measurements made with the Agilent E5061A/E5062A network analyzer with the following conditions:

- No averaging applied to data
- Environmental temperature of 23 °C ±5 °C, with less than 1 °C deviation from the calibration temperature
- Response and isolation calibration not omitted

**Table 1-1 System dynamic range<sup>1 2</sup>**

Description	Specification	SPD
<b>System dynamic range</b>		
300 kHz to 1 MHz, IF bandwidth = 3 kHz	90 dB	
1 MHz to 3 GHz, IF bandwidth = 3 kHz	95 dB	
300 kHz to 1 MHz, IF bandwidth = 10 Hz	115 dB	
1 MHz to 3 GHz, IF bandwidth = 10 Hz	120 dB	130 dB

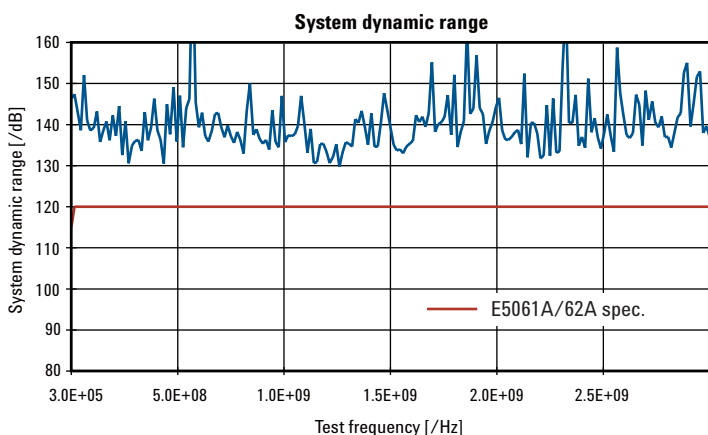

### System dynamic range; specification and measurement example

1. The test port dynamic range is calculated as the difference between the test port rms noise floor and the source maximum output power. The effective dynamic range must take measurement uncertainty and interfering signals into account.
2. Applicable to the units with serial prefix MY442 and above .

**Table 1-2 Corrected system performance with Type-N 50 Ω connectors, 85032F calibration kit, full 2-port calibration**

Network analyzer: E5061A/E5062A, calibration kit: 85032F (Type-N, 50 Ω), calibration: full 2-port

IF bandwidth = 10 Hz, No averaging applied to data, environmental temperature = 23 °C ±5 °C with < 1 °C deviation from calibration temperature, isolation calibration not omitted

Description	Specification (dB)	
	300 kHz to 1.5 GHz	1.5 to 3 GHz
Directivity	49	46
Source match	41	40
Load match	49	46
Reflection tracking	±0.011	±0.021
Transmission tracking	±0.015	±0.018

**Transmission uncertainty (specification)**

Magnitude

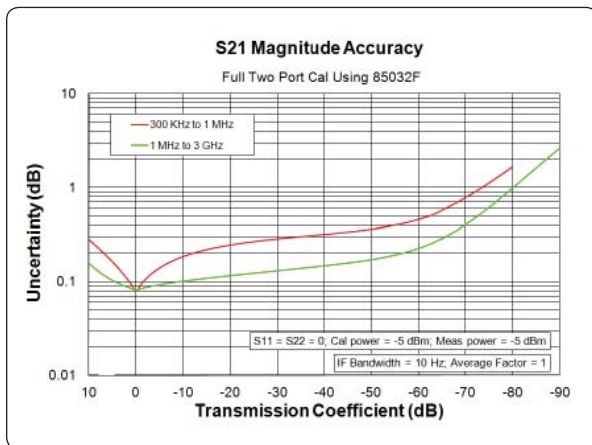

Phase

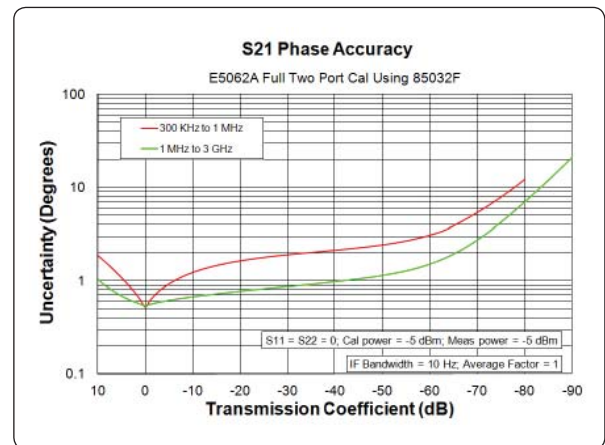

**Reflection uncertainty (specification)**

Magnitude

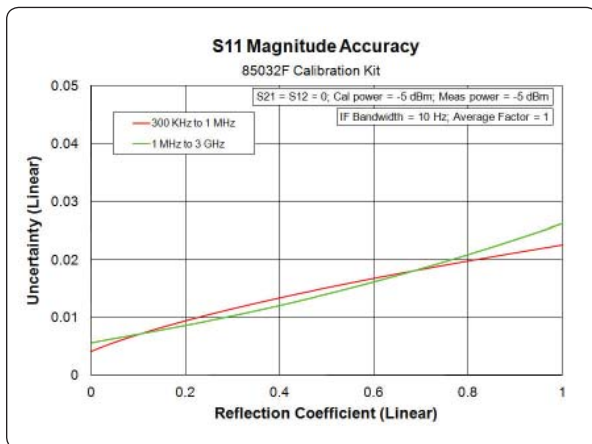

Phase

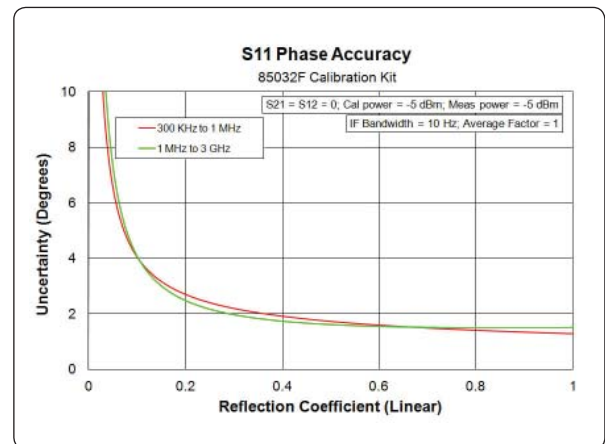

**Table 1-3 Corrected system performance with Type-N 50 Ω connectors, 85032F calibration kit, enhanced response calibration**

Network analyzer: E5061A/E5062A, calibration kit: 85032F (Type-N, 50 Ω) calibration: enhanced response

IF bandwidth = 10 Hz, no averaging applied to data, environmental temperature = 23 °C ±5 °C with < 1 °C deviation from calibration temperature, isolation calibration not omitted

Description	Specification (dB)	
	300 kHz to 1.5 GHz	1.5 to 3 GHz
Directivity	49	46
Source match	41	40
Load match	15	15
Reflection tracking	±0.011	±0.021
Transmission tracking	±0.015	±0.018

**Transmission uncertainty (specification)**

Magnitude

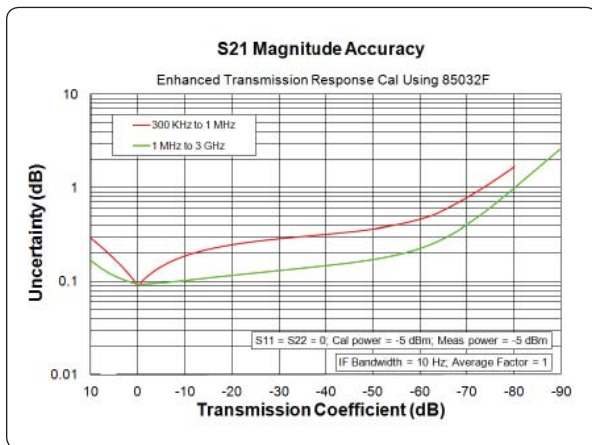

Phase

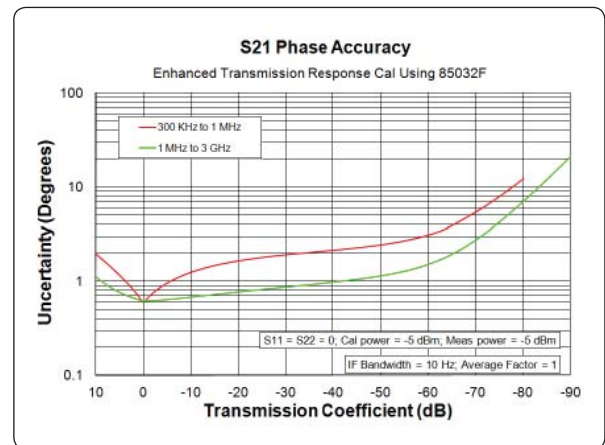

**Reflection uncertainty (specification)**

Magnitude

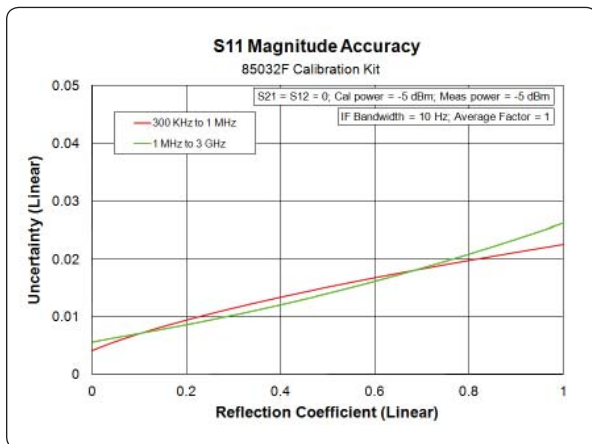

Phase

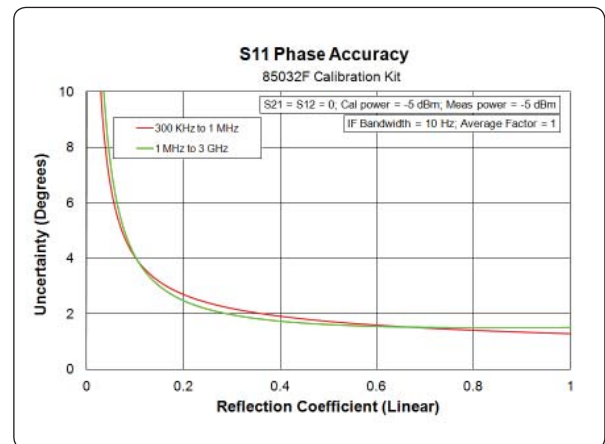

**Table 1-4 Corrected system performance with Type-N 75 Ω connectors  
85036B calibration kit, full 2-port calibration**

Network analyzer: E5061A/E5062A, calibration kit: 85036B (Type-N, 75 Ω), calibration: full 2-port

IF bandwidth = 10 Hz, no averaging applied to data, environmental temperature = 23 °C ±5 °C with < 1 °C deviation from calibration temperature, isolation calibration not omitted

Description	Specification (dB)	
	300 kHz to 1.5 GHz	1.5 to 3 GHz
Directivity	48	44
Source match	41	35
Load match	48	44
Reflection tracking	±0.010	±0.019
Transmission tracking	±0.015	±0.029

**Transmission uncertainty (specification)**

Magnitude

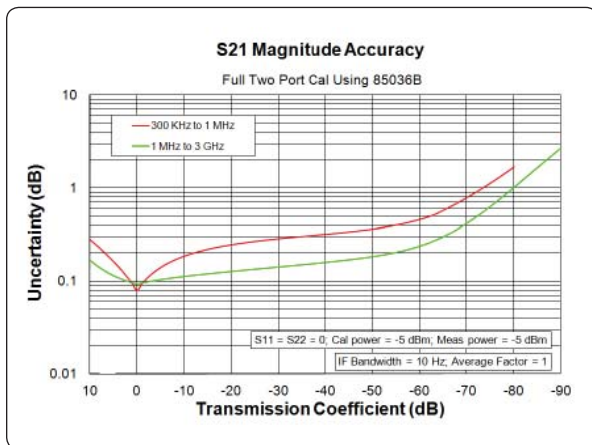

Phase

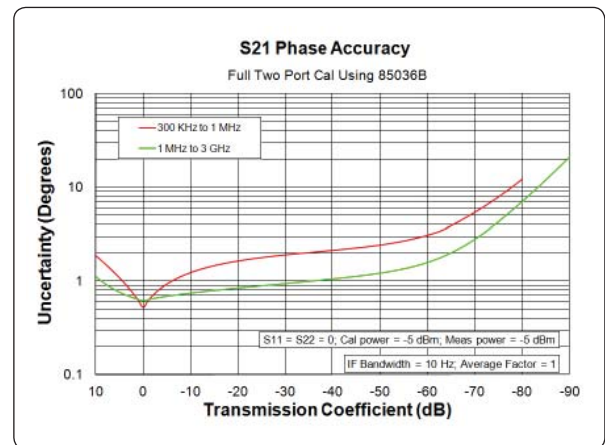

**Reflection uncertainty (specification)**

Magnitude

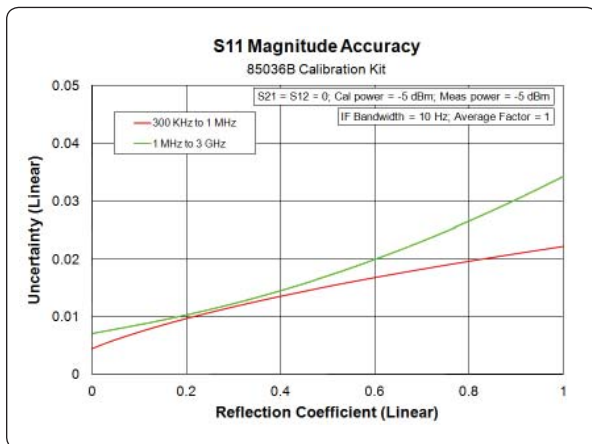

Phase

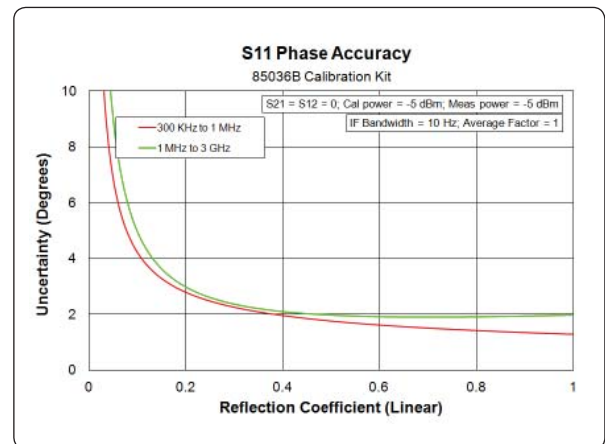

**Table 1-5 Corrected system performance with Type-N 75 Ω connectors  
85036B calibration kit, enhanced response calibration**

Network analyzer: E5061A/E5062A, calibration kit 85036B (Type-N, 75 Ω), calibration: enhanced response

IF bandwidth = 10 Hz, no averaging applied to data, environmental temperature = 23 °C ±5 °C with < 1 °C deviation from calibration temperature, isolation calibration not omitted

Description	Specification (dB)	
	300 kHz to 1.5 GHz	1.5 to 3 GHz
Directivity	48	44
Source match	41	35
Load match	15	15
Reflection tracking	±0.010	±0.019
Transmission tracking	±0.015	±0.029

**Transmission uncertainty (specification)**

Magnitude

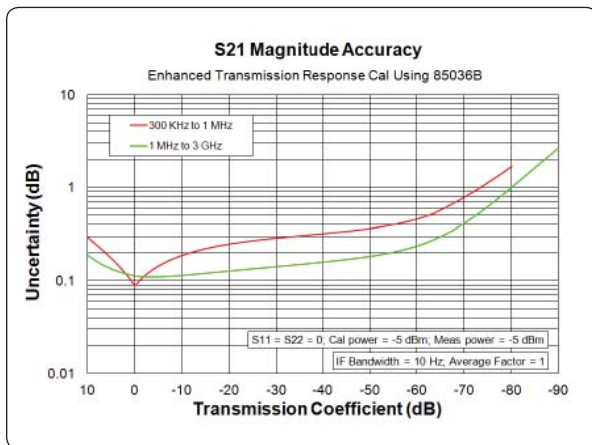

Phase

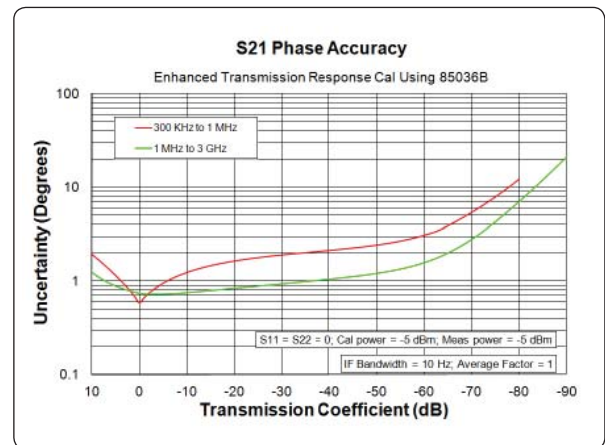

**Reflection uncertainty (specification)**

Magnitude

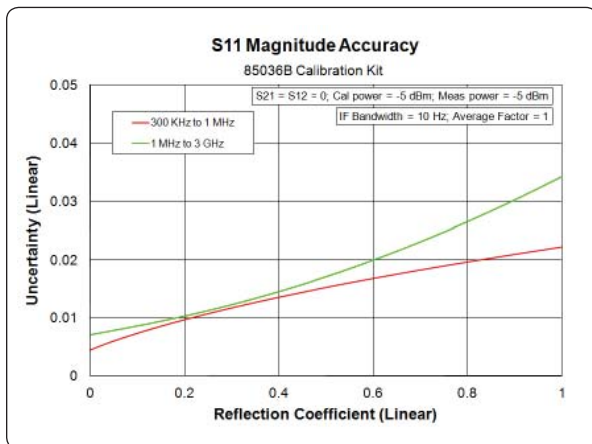

Phase

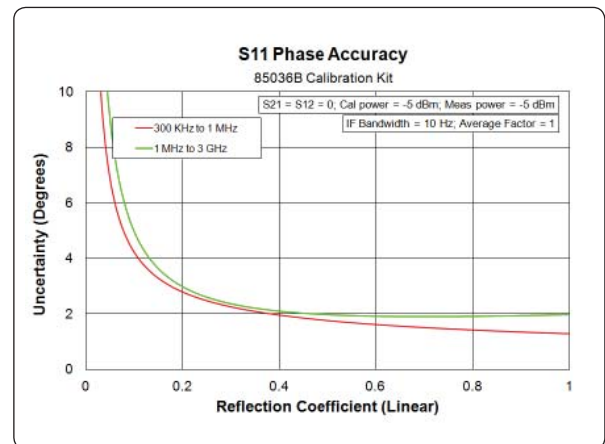

## Uncorrected system performance

**Table 1-6**      **Uncorrected system performance**  
(correction: off, 23 °C ±5 °C)

Description	Specification
	<b>300 kHz to 3 GHz</b>
Directivity	25 dB
Source match	25 dB
Load match	15 dB
Transmission tracking	±1.0 dB
Reflection tracking	±1.0 dB

## Test port output (source)

**Table 1-7**      **Test port output frequency**

Description	Specification	Typical
<b>Range</b>		
E5061A	300 kHz to 1.5 GHz	
E5062A	300 kHz to 3 GHz	
Resolution	1 Hz	
<b>Source stability</b>		
E5061A/E5062A		±5 ppm (5 °C to 40 °C)
<b>CW accuracy</b>		
E5061A/E5062A	±5 ppm, 23 °C ±5 °C	



## Test port output (source)

**Table 1-8 Test port output power**

Description	Specification	Typical
<b>Level accuracy (at 23 °C ±5 °C)<sup>1</sup></b>		
300 kHz to 3 GHz	±0.8 dB (at 0 dBm, 50 MHz absolute) ±1.0 dB (at 0 dBm, relative to 50 MHz reference)	
<b>Level linearity (at 23°C ±5°C)</b>		
300 kHz to 3 GHz	±0.75 dB (at -5 to 10 dBm)	
<b>Range (standard)</b>		
300 kHz to 3 GHz	-5 to 10 dBm	
<b>Range (extended power)</b>		
300 kHz to 3 GHz		-45 to 10 dBm (non-harmonics spurious may limit power range)
<b>Sweep range (without extended power range)</b>		
300 kHz to 3 GHz	-5 to 10 dBm	
<b>Level resolution</b>	0.05 dB	

## Test port output (source)

**Table 1-9 Test port output signal purity**

Description	Specification	Typical
<b>Harmonics (2nd or 3rd)</b>		
10 MHz to 2 GHz		< -25 dBc (at 5 dBm)
<b>Non-harmonic spurious</b>		
10 MHz to 3 GHz		< -30 dBc (at 0 dBm)

1. Level accuracy for 75Ω analyzers is not a specification for frequencies >2 GHz; it is a typical characteristic.

## Test port input

**Table 1-10 Test port input levels**

Description	Specification	Typical
<b>Maximum test port input level</b>		
300 kHz to 3 GHz	+10 dBm	
<b>Damage level</b>		
300 kHz to 3 GHz		+20 dBm, $\pm 30$ VDC
<b>Crosstalk<sup>1</sup></b>		
300 kHz to 3 GHz	-110 dB	

**Table 1-11 Test port input (trace noise<sup>2</sup>)**

Description	Specification	Typical
<b>Trace noise magnitude</b>		
300 kHz to 1 MHz (source power level = +10 dBm)	8 mdB rms (23 °C $\pm 5$ °C)	
1 MHz to 3 GHz (source power level = +10 dBm)	5 mdB rms (23 °C $\pm 5$ °C)	
<b>Trace noise phase</b>		
300 kHz to 1 MHz (source power level = +10 dBm)	0.05° rms (23 °C $\pm 5$ °C)	
1 MHz to 3 GHz (source power level = +10 dBm)	0.03° rms (23 °C $\pm 5$ °C)	

**Table 1-12 Test port input (stability<sup>3</sup>)**

Description	Specification	Typical
<b>Stability magnitude</b>		
3 MHz to 3 GHz		0.01 dB/°C (at 23 °C $\pm 5$ °C)
<b>Stability phase</b>		
3 MHz to 3 GHz		0.1°/°C (at 23 °C $\pm 5$ °C)

1. Response calibration not omitted.

2. Trace noise is defined as a ratio measurement of a through, at IF bandwidth = 3 kHz.

3. Stability is defined as a ratio measurement at the test port.

**Table 1-13 Test port input (dynamic accuracy)**

Accuracy of the test port input power reading is relative to -10 dBm reference input power level.

**Specification**

**Typical**

Magnitude

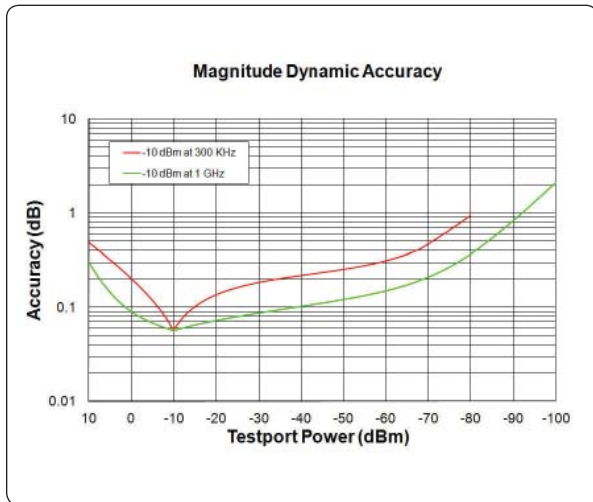

Phase

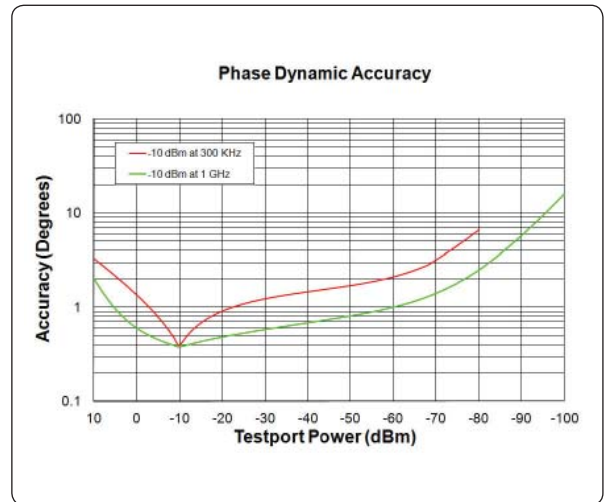
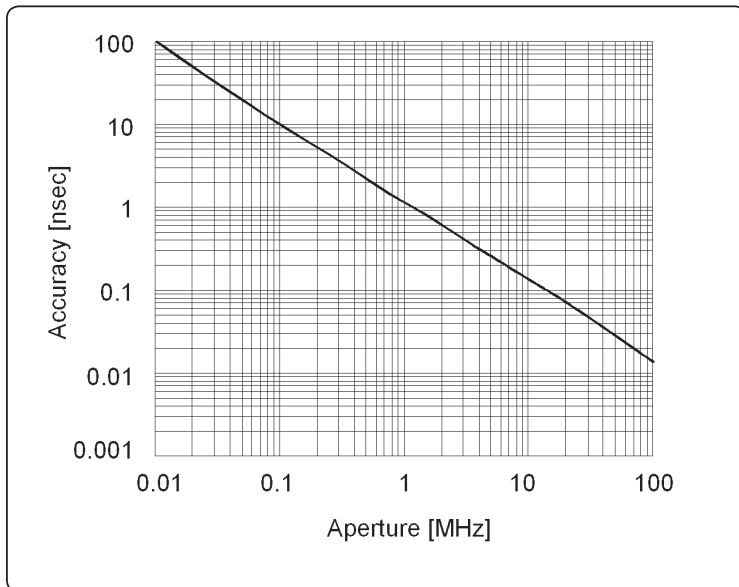

**Table 1-14 Test port input (group delay<sup>1</sup>)**

Description	Specification	Supplemental information
Aperture (selectable)	(frequency span)/(number of points -1)	
Maximum aperture	25% of frequency span	
Minimum delay		Limited to measuring no more than 180° of phase change within the minimum aperture.
Accuracy		See graph below

The following graph shows group delay accuracy with Type-N full 2-port calibration and a 10 Hz IF bandwidth. Insertion loss is assumed to be < 2 dB.

Group delay (typical)



In general, the following formula can be used to determine the accuracy, in seconds, of specific group delay measurement:  
 $\pm \text{phase accuracy (deg)} / [360 \times \text{aperture (Hz)}]$

1. Group delay is computed by measuring the phase change within a specified step (determined by the frequency span and the number of points per sweep).

## General information

**Table 1-15**      **System bandwidths**

Description	General characteristics
<b>IF bandwidth settings</b>	
Range	10 Hz to 30 kHz Nominal settings are: 10, 30, 100, 300, 1 k, 3 k, 10 k, 30 k

**Table 1-16**      **Front panel information**

Description	General characteristics
<b>RF connectors</b>	
Type	Type-N, female; 50 $\Omega$ or 75 $\Omega$
<b>Display</b>	
Size	10.4 in TFT color LCD
Resolution	VGA (640 x 480) <sup>1</sup>





1. Valid pixels are 99.99% and more. Below 0.01% of fixed points of black, blue, green or red are not regarded as failure.

**Table 1-17 Rear panel information**

Description	General characteristics
<b>External trigger connector</b>	
Type	BNC, female
Input level	LOW threshold voltage: 0.5 V HIGH threshold voltage: 2.1 V Input level range: 0 to +5 V
Pulse width	$\geq 2 \mu\text{sec}$
Polarity	Negative (downward) only
<b>External reference signal input connector</b>	
Type	BNC, female
Input frequency	10 MHz $\pm 10$ ppm
Input level	0 dBm $\pm 3$ dB
<b>Internal reference signal output connector</b>	
Type	BNC, female
Output frequency	10 MHz $\pm 10$ ppm
Signal type	Sine wave
Output level	0 dBm $\pm 3$ dB into 50 $\Omega$
Output impedance	50 $\Omega$
<b>VGA video output</b>	15-pin mini D-Sub; female; drives VGA compatible monitors
<b>GPIB</b>	24-pin D-Sub (type D-24), female; compatible with IEEE-488
<b>Parallel port</b>	36-pin D-Sub (type 1284-C), female; provides connection to printers, or multiport test set
<b>USB port</b>	Universal serial bus jack, type A configuration (4 contacts inline, contact 1 on left); female; provides connection to printer, ECal module, USB/GPIB interface
Contact 1	Vcc: 4.75 to 5.25 VDC, 500 mA, maximum
Contact 2	-Data
Contact 3	+Data
Contact 4	Ground
<b>LAN</b>	10/100 BaseT Ethernet, 8-pin configuration; auto selects between the two data rates
<b>Handler I/O port</b>	36-pin Centronics, female; provides connection to handler system
<b>Line power<sup>1</sup></b>	
Frequency	47 Hz to 63 Hz
Voltage	90 to 132 VAC, or 198 to 264 VAC (automatically switched)
VA max	350 VA max.

1. A third-wire ground is required.

**Table 1-18 EMC and safety**

Description	General characteristics
<b>EMC</b>	
	European Council Directive 89/336/EEC EN / IEC 61326-1:1997+A1:1998 CISPR 11:1997+A1:1999 / EN 55011:1998+A1:1999 Group 1, Class A IEC 61000-4-2:1995 / EN 61000-4-2:1995+A1:1998 4 kV CD / 4 kV AD IEC 61000-4-3:1995 / EN 61000-4-3:1996+A1:1998 3 V/m, 80-1000 MHz, 80% AM IEC 61000-4-4:1995 / EN 61000-4-4:1995 1 kV power / 0.5 kV Signal IEC 61000-4-5:1995 / EN 61000-4-5:1995 0.5 kV Normal / 1 kV Common IEC 61000-4-6:1996 / EN 61000-4-6:1996 3 V, 0.15-80 MHz, 80% AM IEC 61000-4-11:1994 / EN 61000-4-11:1994 100% 1cycle
<b>ICES/NMB-001</b>	Canada ICES001:1998 Note: The performance of EUT will be within the specification over the RF immunity tests according to EN 61000-4-3 or EN 61000-4-6 except under the coincidence of measurement frequency and interference frequency.
	AS/NZS 2064.1/2 Group 1, Class A
<b>Safety</b>	
	European Council Directive 73/23/EEC IEC 61010-1:1990+A1+A2 / EN 61010-1:1993+A2 INSTALLATION CATEGORY II, POLLUTION DEGREE 2 INDOOR USE IEC60825-1:1994 CLASS 1 LED PRODUCT
	CAN/CSA C22.2 No. 1010.1-92

**Table 1-19 Analyzer environment and dimensions**

Description	General characteristics
<b>Operating environment</b>	
Temperature	+5 °C to +40 °C
Error-corrected temperature range	23 °C ±5 °C with < 1 °C deviation from calibration temperature
Humidity	20% to 80% at wet bulb temperature < +29 °C (non-condensing)
Altitude	0 to 2,000 m (0 to 6,561 feet)
Vibration	0.5 G maximum, 5 Hz to 500 Hz
<b>Non-operating storage environment</b>	
Temperature	-10 °C to +60 °C
Humidity	20% to 90% at wet bulb temperature < 40 °C (non-condensing)
Altitude	0 to 4,572 m (0 to 15,000 feet)
Vibration	0.5 G maximum, 5 Hz to 500 Hz
<b>Dimensions</b>	See figure 1-1 through figure 1-3.
<b>Weight</b>	13.5 kg

**Figure 1-2. Dimensions (front view, in millimeters)**

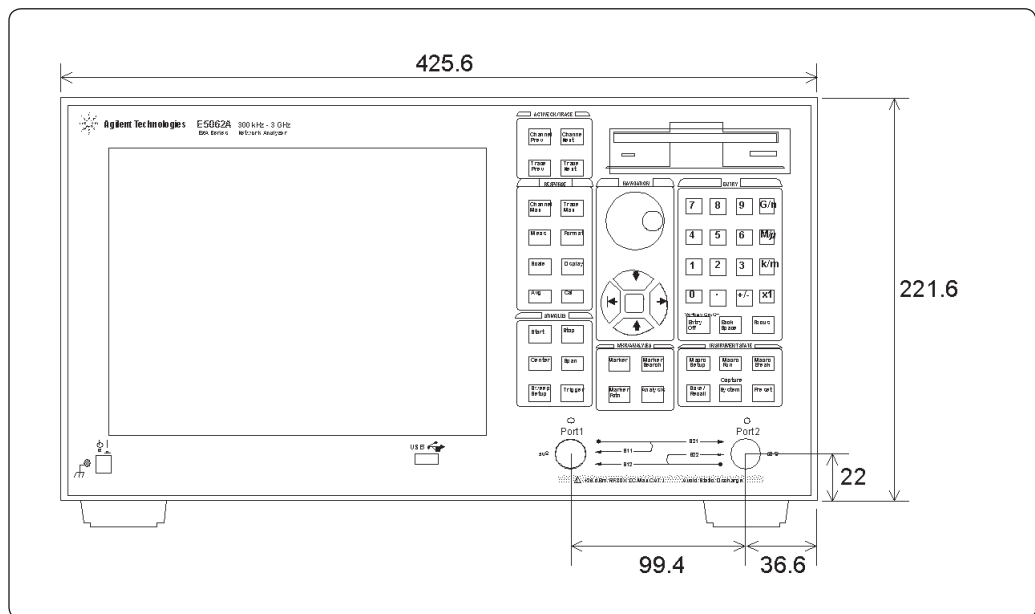





## Measurement throughput summary

**Table 1-20 Typical cycle time for measurement completion<sup>1</sup> (ms) (Display update: off)**

	Number of points			
	51	201	401	1601
<b>Start 1 GHz, stop 1.2 GHz, 30 kHz IF bandwidth</b>				
Uncorrected	8	19	33	117
2-port cal	14	35	63	230
<b>Start 300 kHz, stop 1.5 GHz, 30 kHz IF bandwidth</b>				
Uncorrected	15	25	39	123
2-port cal	27	48	75	243
<b>Start 300 kHz, stop 3 GHz, 30 kHz IF bandwidth</b>				
Uncorrected	17	28	41	125
2-port cal	31	53	80	247

**Table 1-21 Typical cycle time for measurement completion<sup>1</sup> (ms) (Display update: on)**

	Number of points			
	51	201	401	1601
<b>Start 1 GHz, stop 1.2 GHz, 30 kHz IF bandwidth</b>				
Uncorrected	59	68	83	172
2-port cal	85	103	131	304
<b>Start 300 kHz, stop 1.5 GHz, 30 kHz IF bandwidth</b>				
Uncorrected	64	74	89	178
2-port cal	95	116	144	317
<b>Start 300 kHz, stop 3 GHz, 30 kHz IF bandwidth</b>				
Uncorrected	66	78	91	180
2-port cal	98	121	148	322

1. Typical performance.

**Table 1-22 Data transfer time<sup>1</sup> (ms)**

<b>Number of points</b>	<b>51</b>	<b>201</b>	<b>401</b>	<b>1601</b>
<b>SCPI over GPIB<sup>2</sup></b>				
REAL 64	6	14	25	89
ASCII	51	193	383	1522
<b>SCPI over 100 Mbps LAN (telnet)<sup>2</sup></b>				
REAL 64	3	3	4	6
ASCII	92	354	510	2040
<b>SCPI over 100 Mbps LAN (SICL-LAN)<sup>2</sup></b>				
REAL 64	7	7	8	12
ASCII	9	21	34	127
<b>COM (program executed in the analyzer)<sup>2</sup></b>				
Variant type	2	2	2	2

1. Typical performance.

2. Measured using a VEE 6.01 program running on a 500 MHz Pentium® III Dell Optiplex, Transferred complex S<sub>11</sub> data, using :CALC:DATA?SDATA.

## Measurement capabilities

<b>Number of measurement channels</b>	Up to 4 independent measurement channels. A measurement channel is coupled to stimulus response settings including frequency, IF bandwidth, power level, and number of points.
<b>Number of display windows</b>	Each measurement channel has a display window. Up to 4 display windows (channels) can be displayed.
<b>Number of traces</b>	4 data traces and 4 memory traces per channel
<b>Measurement choices</b>	Option E5061A/E5062A-150/175: $S_{11}$ , $S_{21}$ Option E5061A/E5062A-250/275: $S_{11}$ , $S_{21}$ , $S_{12}$ , $S_{22}$
<b>Measurement parameter conversion</b>	Available to convert S-parameters into reflection impedance, transmission impedance, reflection admittance, transmission admittance, and 1/S.
<b>Data formats</b>	Log magnitude, linear magnitude, phase, expanded phase, positive phase, group delay, SWR, real, imaginary, Smith chart, polar.
<b>Data markers</b>	10 independent markers per trace. Reference marker available for delta marker operation. Smith chart format includes 5 marker formats: linear magnitude/phase, log magnitude/phase, real/imaginary, $R + jX$ , and $G + jB$ . Polar chart format includes 3 marker formats: linear magnitude/phase, log magnitude/phase, and real/imaginary.
<b>Marker functions</b>	
Marker search	Max value, min value, multi-peak, multi-target, peak, peak left, peak right, target, target left, target right, and width parameters with user-defined bandwidth values.
Marker-to functions	Set start, stop, center to active marker stimulus value; set reference to active marker response value; set electrical delay to group delay at active marker.
Search range	User definable.
Tracking	Performs marker search continuously or on demand.
<b>Fault location functions (Option E5061A/E5062A-100)</b>	
Transformation to distance and time domain	Selectable transformation type from bandpass, lowpass impulse, lowpass step. Selectable window from maximum, normal and minimum.
<b>LXI compliance</b>	Class C (only applies to units that are shipped with firmware revision A.03.00 or later).

## Source control

<b>Measured number of points per sweep</b>	User definable from 2 to 1601.
<b>Sweep type</b>	Linear sweep, segment sweep, log sweep and power sweep.
<b>Segment sweep</b>	Define independent sweep segments. Set number of points, test port power levels, IF bandwidth, delay time, sweep time and sweep mode independently for each segment.
<b>Sweep trigger</b>	Set to continuous, hold, or single, sweep with internal, external, manual, or bus trigger.
<b>Power</b>	Set source power from -5 dBm (-45 dBm for option E5061A/E5062A-1E1/250/275) to 10 dBm. The power slope function compensates source power level error.

## Trace functions

<b>Display data</b>	Display current measurement data, memory data, or current measurement and memory data simultaneously.
<b>Trace math</b>	Vector addition, subtraction, multiplication or division of measured complex values and memory data.
<b>Title</b>	Add custom title to each channel window. Titles are printed on hardcopies of displayed measurements.
<b>Autoscale</b>	Automatically selects scale resolution and reference value to vertically center the trace.
<b>Electrical delay</b>	Offset measured phase or group delay by a defined amount of electrical delay, in seconds.
<b>Phase offset</b>	Offset measured phase or group delay by a defined amount in degrees.
<b>Statistics</b>	Calculates and displays mean, standard deviation and peak-to-peak deviation of the data trace.

## Data accuracy enhancement

<b>Measurement calibration</b>	Measurement calibration significantly reduces measurement uncertainty due to errors caused by system directivity, source and load match, tracking and crosstalk. Full 2-port calibration removes all the systematic errors for the related test ports to obtain the most accurate measurements.
<b>Calibration types available</b>	
Response	Simultaneous magnitude and phase correction of frequency response errors for either reflection or transmission measurements.
Response and isolation	Compensates for frequency response and crosstalk errors of transmission measurements.
Enhanced response	Compensates for frequency response and source match errors
One-port calibration	Compensates for directivity, frequency response and source match errors.
Full 2-port calibration (Option E5061A/E5062A-250/275)	Compensates for directivity, source match, reflection tracking, load match, transmission tracking and crosstalk. Crosstalk calibration can be omitted.
<b>Interpolated error correction</b>	With any type of accuracy enhancement applied, interpolated mode recalculates the error coefficients when the test frequencies are changed. The number of points can be increased or decreased and the start/stop frequencies can be changed.
<b>Velocity factor</b>	Enter the velocity factor to calculate the equivalent physical length.
<b>Reference port extension</b>	Redefine the measurement plane from the plane where the calibration was done.

## Storage

<b>Internal hard disk drive</b>	Store and recall instrument states, calibration data, and trace data on 10 GB, minimum, internal hard drive. Trace data can be saved in CSV (comma separated value) format. All files are MS-DOS <sup>®</sup> -compatible. Instrument states include all control settings, limit lines, segment sweep tables, and memory trace data.
<b>File sharing</b>	Internal hard disk drive (D:) can be accessed from an external Windows <sup>®</sup> PC through LAN.
<b>Disk drive</b>	Instrument states, calibration data, and trace data can be stored on an internal 3.5 inch 1.4 MB floppy disk in MS-DOS <sup>®</sup> -compatible format.
<b>Screen hardcopy</b>	Printouts of instrument data are directly produced on a printer. The analyzer provides USB and parallel interfaces.

## System capabilities

<b>Familiar graphical user interface</b>	The ENA-L analyzer employs a graphical user interface based on Windows <sup>®</sup> operating system. There are three ways to operate the instrument manually: you can use a hardkey interface, touch screen interface (option E5061A/E5062A-016) or a mouse interface.
<b>Limit lines</b>	Define the test limit lines that appear on the display for pass/fail testing. Defined limits may be any combination of horizontal/sloping lines and discrete data points.

## Automation

	<b>GPIB</b>	<b>Internal</b>
SCPI	X	X
COM		X

### Methods

Internal analyzer execution	Applications can be developed in a built-in VBA® (Visual Basic for Applications) language. Applications can be executed from within the analyzer via COM (component object model) or using SCPI.
Controlling via GPIB	The GPIB interface operates to IEEE 488.2 and SCPI protocols. The analyzer can be controlled by a GPIB external controller. The analyzer can control external devices using a USB/GPIB interface.

### LAN

Standard conformity	10 BaseT or 100 BaseTX (automatically switched), Ethertwist, RJ45 connector
Protocol	TCP/IP
Function	Telnet, SICL-LAN

## Web Resources

For additional literature and product information about the Agilent ENA-L visit:

[www.agilent.com/find/ena](http://www.agilent.com/find/ena)

 **Agilent Email Updates**

[www.agilent.com/find/emailupdates](http://www.agilent.com/find/emailupdates)  
Get the latest information on the products and applications you select.



[www.lxistandard.org](http://www.lxistandard.org)  
LAN eXtensions for Instruments puts the power of Ethernet and the Web inside your test systems. Agilent is a founding member of the LXI consortium.

**Agilent Channel Partners**

[www.agilent.com/find/channelpartners](http://www.agilent.com/find/channelpartners)  
Get the best of both worlds: Agilent's measurement expertise and product breadth, combined with channel partner convenience.



Agilent Advantage Services is committed to your success throughout your equipment's lifetime. To keep you competitive, we continually invest in tools and processes that speed up calibration and repair and reduce your cost of ownership. You can also use Infoline Web Services to manage equipment and services more effectively. By sharing our measurement and service expertise, we help you create the products that change our world.

[www.agilent.com/find/advantageservices](http://www.agilent.com/find/advantageservices)



[www.agilent.com/quality](http://www.agilent.com/quality)

For more information on Agilent Technologies' products, applications or services, please contact your local Agilent office. The complete list is available at:

[www.agilent.com/find/contactus](http://www.agilent.com/find/contactus)

**Americas**

Canada	(877) 894 4414
Brazil	(11) 4197 3600
Mexico	01800 5064 800
United States	(800) 829 4444

**Asia Pacific**

Australia	1 800 629 485
China	800 810 0189
Hong Kong	800 938 693
India	1 800 112 929
Japan	0120 (421) 345
Korea	080 769 0800
Malaysia	1 800 888 848
Singapore	1 800 375 8100
Taiwan	0800 047 866
Other AP Countries	(65) 375 8100

**Europe & Middle East**

Belgium	32 (0) 2 404 93 40
Denmark	45 45 80 12 15
Finland	358 (0) 10 855 2100
France	0825 010 700*
	*0.125 €/minute
Germany	49 (0) 7031 464 6333
Ireland	1890 924 204
Israel	972-3-9288-504/544
Italy	39 02 92 60 8484
Netherlands	31 (0) 20 547 2111
Spain	34 (91) 631 3300
Sweden	0200-88 22 55
United Kingdom	44 (0) 118 927 6201

*For other unlisted countries:*

[www.agilent.com/find/contactus](http://www.agilent.com/find/contactus)

Revised: January 6, 2012

Product specifications and descriptions in this document subject to change without notice.

© Agilent Technologies, Inc. 2012  
Published in USA, July 27, 2012  
5989-0018EN

*Microsoft®, Windows® and Visual Basic® are U.S. registered trademarks of Microsoft Corporation.*

*Pentium® is a US registered trademarks of Intel Corporation.*

