

NETWORK ANALYZERS

Combined Network/Spectrum Analysis, 10Hz to 500MHz

Model 4195A

- Linear and non-linear device measurement and analysis
- High accuracy and resolution
- User functions
- Color graphics, graphics analysis and direct copy capability
- Direct save/recall with internal disc drive

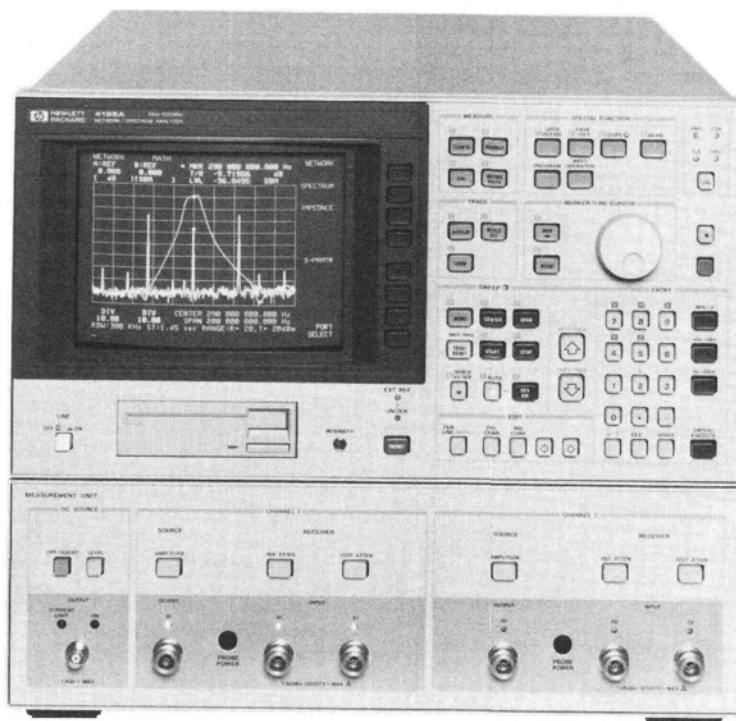

HP 4195A



Description

The HP 4195A is a high performance, cost effective and intelligent analyzer with combined vector network and spectrum analysis capabilities. The frequency is covered from 10Hz through 500MHz with an excellent 0.001 Hz resolution for audio, baseband, HF, VHF and IF applications. It directly measures amplitude ratio, phase, group delay and spectrum level needed for characterizing linear/non-linear analog circuits or components used in communications, telecommunications, consumer electronics and other equipment.

The HP 4195A's excellent accuracy and resolution meets the severe measurement requirements for developing advanced equipment. A color display allows you to readily differentiate between multiple traces. Convenient softkey operation and marker functions make deriving device parameters quick and easy. Measurement results can be directly copied to printer or plotter without an external computer. Furthermore, the HP 4195A has internal user functions for computing and self controlling capability. User Program, User Defined Function and User Math allows you to quickly customize the setups most suited to your application without using an external computer. A built-in 3.5 inch disc drive can save the instrument state, data and user functions.

Combined Vector Network and Spectrum Analysis

Network analyzers and spectrum analyzers have become essential tools for evaluating subsystems or components used in electronic equipment. Especially, the importance of phase and group delay measurements is rapidly increasing. The HP 4195A offers full network and spectrum analysis from 10Hz to 500MHz at half the price. It has very wide applications. Network analysis functions include characterizing the gain/group delay ripple of filters and amplifiers. Spectrum

analysis functions include the harmonic, intermodulation distortion of amplifiers or IF subsystems in communications and telecommunications. S-parameters can also be measured by using 2 transmission/reflection test sets, without changing direction of the device.

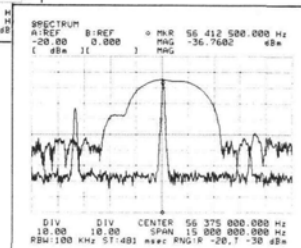
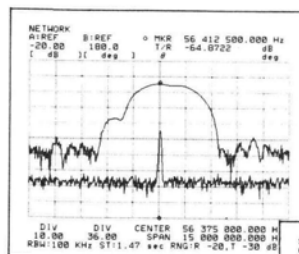

High Accuracy and Resolution Measurement

The HP 4195A measures amplitude ratio and phase with an accuracy of $\pm 0.05\text{dB}/\pm 0.3$ deg and a resolution of $0.001\text{dB}/0.01$ deg. The amplitude and phase distortion of transmission devices, such as filters, amplifiers, delay lines and cables, affect the quality of information and create bit errors in PSK or QAM systems. The HP 4195A can evaluate distortion with high accuracy and resolution. For accuracy enhancement, 1 Port Full Cal, 1 Port Partial Cal, Normalization and Port Extension capabilities are available. For spectrum analysis, high level accuracy of $\pm 0.1\text{dB}$ and fully synthesized pure local OSC, typically -100dBc/Hz (100 Hz offset), allow you to obtain stable and reliable C/N, harmonic distortion or intermodulation distortion measurements. In addition the high shaped digital IF filter technique makes discrimination of closely spaced signals easy, so 50/60 Hz power-line sidebands can be measured using the $\sim 0\text{Hz}$ RBW.

User Functions for Easy Customized Operation

The HP 4195A has three user functions for customizing operations for your applications without using an external computer. The User Program gives you a one key solution for performing your application. You can program a sequence from measurement and marker control, computing, through printing a hard copying. This function is very useful and improves efficiency for C/N (Carrier Noise ratio), THD (Total Harmonic Distortion) measurements or automatic device parameter extraction, such as an amplifier's gain, group delay, gain compression or harmonic distortion. The User Math function helps you put the result in the form you need by using the built-in math operators and arithmetic functions. For example, you can display level in volt peak-to-peak instead of volts rms or perform differentiation of gain or max hold. The User Defined Function gives you the power to define functions which can be called with softkeys as you like, such as input of step size, signal tracking, transmission/reflection alternate sweep or gain/level spectrum alternate sweep. In addition, the HP 4195A has the Program Sweep function which can arbitrarily sweep the points programmed in the table. This increases measurement efficiency by reducing excessive points in the Lin or Log sweep. Also, the resolution bandwidth can be independently set for each programmed point. The above user functions and program sweep table can be saved into the built-in 3.5 inch disc, so you can start your application at any time.

```

SPECTRUM          C/N-MEASUREMENT
PROGRAM EDITOR
FILE NAME: CN1

1 | C/N-MEASUREMENT
10 MCF2
20 DELT1
30 MKACT1
40 MKMX
50 DMKR=1 MHZ:R1=0
60 FOR R0=1 TO 10
70 SWTNG
80 R1=DMKRA+R1

90 R2=R1/R0
100 DISP "C/(DB)="+R2
110 NEXT R0
120 CRT "C/N-MEASUREMENT"
130 END
  
```

User Program for C/N Measurement

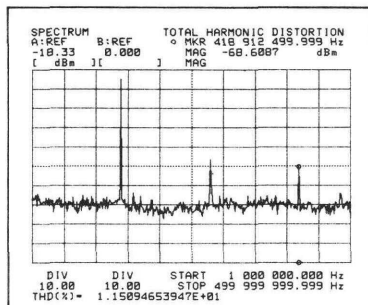

THD Measurement by Using User Define Function

Advanced Marker Action on Color Graphics

The application oriented marker functions are very useful for both network and spectrum measurements. You can quickly obtain the desired results from the easy to see color graphics CRT. The Next Peak is convenient for searching harmonic or spurious signals. The marker target is used for extraction of SAW filter's 3dB bandwidth or an amplifier's -1dB gain compression point. The delta marker is used for C/N measurement, and the noise marker is used for noise measurements. A maximum of four traces can be simultaneously displayed on the CRT, so it is easy to compare the data. The smith/polar chart is convenient for impedance matching in circuit design. In addition, the results can be directly copied to a compatible plotter or printer without an external computer.

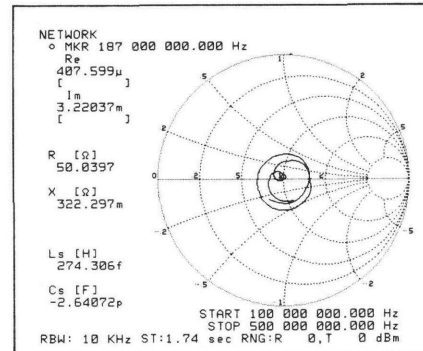

Specifications

Network Measurement

Source

Frequency: 10Hz to 500MHz, 1mHz resolution
Power: -50dBm to $+15\text{dBm}$, 0.1dB resolution
Sweep Parameters: Frequency, power and dc bias level
Sweep Types: Linear, log, cw, program and partial
Output: 2 outputs
DC bias level: $\pm 40\text{V}$, 10mV resolution

Receiver

Frequency: 10Hz to 500MHz
Input: 4 inputs, 50 nominal
Resolution Bandwidth: 3Hz to 300kHz, 1 or 3 step
Input Crosstalk: $< -100\text{dB}$

Magnitude Ratio

Dynamic Range: $> 100\text{dB}$
Resolution: 0.001dB
Dynamic Accuracy ($23 \pm 5^\circ\text{C}$), -30dBm R input: $\pm 0.05\text{dB}$ @ -70dBm to -30dBm T input.

Phase

Range: $\pm 180^\circ$
Resolution: 0.01°
Dynamic Accuracy ($23 \pm 5^\circ\text{C}$, -30dBm input): $\pm 0.3^\circ$ @ -70 to -30dBm T input.

Delay

Range: 10ps to 500s
Resolution: 10ps @ 3.6 MHz aperture
Accuracy: depends on phase accuracy

Error Compensation

Mode: Normalization, 1 port partial cal, 1 port full cal and port extension.

Spectrum Measurement

Frequency

Measurement Range: 10Hz to 500MHz
Resolution:
RBW: 3Hz to 300kHz, 1 or 3 step
Selectivity (60/3dB): 4.5 for 3Hz to 30Hz, 9 for 100 Hz to 10 kHz,
 8.5 for 30 kHz to 300 kHz.
Noise Sideband: $< -100\text{dBc/Hz}$ @ 1 kHz offset
 $< -90\text{dBc/Hz}$ @ 100 Hz offset

NETWORK ANALYZERS

Combined Network/Spectrum Analysis, 10Hz to 500MHz (cont'd)

Model 4195A

Amplitude

Measurement Range: -135 dBm to +20 dBm

Accuracy: ± 1.0 dB 50MHz

Linearity ($23 \pm 5^\circ\text{C}$): ± 0.1 dB @ -40 to 0dB; ± 0.2 dB @ -60 to -40dB

Frequency Response: ± 1.5 dB

Dynamic Range ($23 \pm 5^\circ\text{C}$)

Second Harmonic Distortion: < -70 dBc @ > 2 MHz

T.O.I Distortion: < -80 dBc @ > 2 MHz

Residual Response: -110dB @ > 100 kHz.

Average Noise Level: typically -140dBm @ 10Hz RBW, > 2 MHz

Sweep

Sweep Type: Linear, log, cw, program and partial

Sweep Mode: Continuous, single and manual

Sweep Time: approximately 3.5 sec 500 MHz span, 300 kHz RBW

Input

Number of inputs: 4 inputs

Impedance: 50 nominal

Damage level: +30 dBm

Attenuator: 0 to 50dB, 10dB step

Display and Analysis

Display: 7.5 inch color CRT

Display Format: Rectangulars, Table, Smith and Polar

Traces: 4 traces max

Scale Type: Linear, log

Autoscale

Phase Display Expansion: Display phase continuously more than ± 180 deg.

Video Filter: Digital video filtering reduces random noise

Comment Entry: Display a comment used alphabet, numeral and special characters (., %, etc).

Marker: MKR \rightarrow Max (Min, Ref, Center, Start and Stop), Next Peak, Width and Delta reading mode.

User Functions

User Math:

Puts the result in the form needed for your application by using built-in math operators, arithmetic functions and editing capability.

User Defined Function:

Provides one-key solution for a specific application without an external computer. 6 user functions can be created and soft-keys can be labeled as you like.

User Program (Auto Sequence Program):

Allows to program the control or measurement, analysis, copy and other sequence without an external computer.

Hardcopy

Hardcopy of traces, measurement data, results of analysis and annotations are produced by the 4195A and HP plotters or printers with LISTEN only capability.

Color Dump Mode: Copy the traces, graticules and annotations to a color graphics printer. Colors are fixed.

Dump Mode: Copy the CRT display to a graphics printer

Plot Mode: Copy the traces, graticule and annotations to an HP-GL compatible digital plotter

Print Mode: Copy measurement data in tabular form to a printer

Storage

Instrument state, trace data, table of Program Sweep and User Program can be independently saved or recalled from the built-in 3.5 inch floppy disk memory via SAVE/GET function.

Instrument state includes active control setting of measurement, active calibration data, active display format, active scale setting, User Math and User Define Function.

Remote programming: according to IEEE 488-1987 and IEC HP-IB interface operates according to IEEE 488-1987 and IEC 625 standards and IEEE 628-1982 recommended practices

Interface Function: SH1, AH1, T5, TEO, L4, LEO, SR1, RL1, PPO, DC1, DT1, CO, EI

Transfer Formats: ASCII

32/64 bit IEEE 754 floating point format

General Characteristics:

Operating Conditions:

Temperature: 0°C to $+45^\circ\text{C}$

Humidity: 95% RH at 40°C

Non-Operating Conditions:

Temperature: -40°C to $+70^\circ\text{C}$

Safety: Based on IEC-348, UL-1244

Power: 100, 120, 220V $\pm 10\%$, 240V -10% +5%, 48Hz to 60Hz, 500VA (max)

Dimensions: 425 (W) x 375 (H) x 620 (D) mm

Weight: Approximately 41kg

41951A Impedance Test Kit

The HP 4195A and HP 41951A Impedance Test Kit, which is designed to use with the 4195A, can be used to perform impedance analysis from 100kHz to 500MHz. The direct reading of impedance parameters, error compensation, variable test signal/dc bias level, and dedicated analysis functions are all convenient for evaluation of components, such as crystal/SAW resonators, coils, and varicap diodes. The equivalent circuit function is very useful for modeling and evaluating components under actual operating conditions to improve the quality and reliability of circuit design.

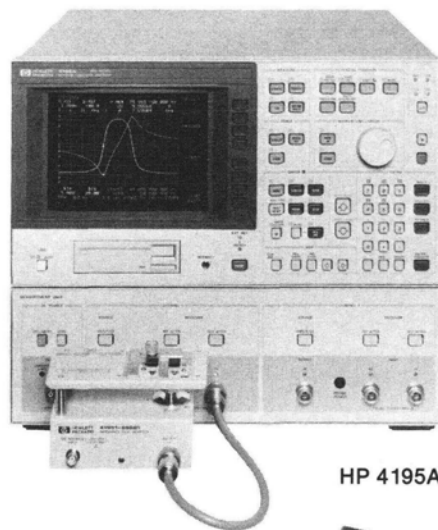

HP 4195A with HP 41951A



HP 41951A

HP 41951A Impedance Test Kit

The HP 41951A can be used for impedance measurements from 100kHz to 500MHz when used with the HP 4195A.

Measured Parameters: $|Z|$, $|Y|$, θ , L , C , R , X , G , B , D , and Q

Error Compensation: 1 port cal, open/short offset and port extension

Equivalent Circuit Analysis: Circuit constants approximation and simulation of frequency characteristics

Available Accessories: Refer to page 283.

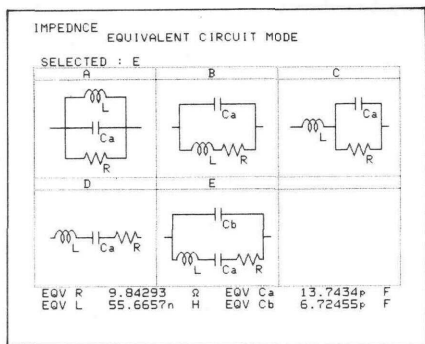

HP 4195A With HP 41952A

41952A/B Transmission/Reflection Test Sets

The HP 41952A/B Transmission/Reflection Test Sets provide a neat solution to the HP 4195A Network/Spectrum Analyzer to measure both transmission and reflection characteristics. The HP 41952A/B are directly connected to the HP 4195A and include a power splitter and a directional coupler in each compact box. Furthermore, two test sets of the HP 41952A or 41952B (opt. 009) allow the HP 4195A to perform full s parameters measurement without having to remove and reverse the device. The HP 41952A is used for 50 ohm application, and the HP 41952B is used for 75 ohm application.

41800A Active Probe

The HP 41800A Active Probe is a high input impedance probe which covers the frequency from 5Hz to 500MHz, and makes it easy to perform signal analysis of circuits in audio, video, HF and VHF band. For both signal spectrum and network analysis, the HP 41800A presents a great value by its low distortion and low noise characteristics. The HP 41800A is directly compatible with HP analyzers, such as the HP 4195A, HP 3577A, HP 3585A or HP 8568B, which supply probe power from the front panel.

Specifications

- Bandwidth:** 5Hz to 500MHz
- Input R, C (nominal):** 100k ohm, 3pF (probe alone)
- Average Noise Level (typical):** 10^{-14} W/Hz 300kHz to 500MHz
- 2nd Harmonic Distortion:** < -50dBc -20dBc input
- Output Connector:** 50 ohm type N male
- Accessories Furnished:** 10:1 divider, hook tip, ground leads, spare tips, BNC male adaptor and so on

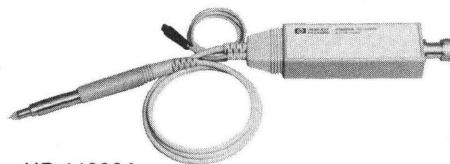

HP 41800A

SPECIFICATIONS

	HP 41952A	HP 41952B
Impedance:	50 ohm	75 ohm
Frequency Range:	100kHz - 500MHz	100kHz - 500MHz
Directivity:	40dB @300kHz-200MHz	35dB @300kHz-200MHz
Frequency Response: *1		
Transmission Magnitude, Phase (@ ≥ 300 kHz) :	± 1 dB, ± 5 deg	± 1 dB, ± 5 deg
Reflection Magnitude, Phase (@ ≥ 1 MHz) :	± 1 dB, ± 5 deg	± 1 dB, ± 5 deg
Effective Source Match:		
Test Port:	>20dB @ ≥ 300 kHz	>20dB @ ≥ 300 kHz
Connector:		
Test Port:	50 ohm type N-(f)	75 ohm type N-(f)
Accessories Furnished:	50 ohm N cable Operating Note Carrying Case	50 ohm N cable HP 11852B M. L. Pad Operating Note Carrying Case

Note: HP 41952B opt. 009 deletes 50 ohm N cable and HP 11852B.
*1 : Typical

Accessories Available

- HP 85044A/B** Transmission/Reflection Test Set
Refer to page 232.
- HP 85024A** High Frequency Probe
Refer to page 230.

Ordering Information

4195A Network/Spectrum Analyzer	Price
Opt W30: 3-year hardware support	\$25,000
Opt 001: High Stability Frequency Reference Improve the stability of frequency for evaluation high Q devices such as crystal filter, oscillator or resonator.	\$575
Frequency Accuracy: ± 1 ppm (23°C ± 5 °C)	\$850
Frequency Stability: $\pm 1 \times 10^{-8}$ (23°C ± 5 °C)	
Opt 907: Front Handle Kit	\$133
Opt 908: Rack Flange Kit	\$74
Opt 909: Rack and Handle Kit	\$189
Opt 910: Extra OP manual	\$50
41951A Impedance Test Kit	\$1500
41952A 50 Transmission/Reflection Test Set	\$2200
41952B 75 Transmission/Reflection Test Set	\$2700
Opt 009: Delete 50 N Cable and 11852B	-\$500
41800A Active Probe	\$1700