

**SERIES  
37XXXD  
VECTOR NETWORK ANALYZER  
OPERATION MANUAL**

---

---

The Anritsu logo is centered at the bottom of the page. It features the word "Anritsu" in a bold, sans-serif font. The letter "A" is stylized with a diagonal slash. The logo is flanked by two horizontal lines on each side, which are part of a larger decorative element consisting of two parallel lines extending across the width of the page.

### **WARRANTY**

The ANRITSU product(s) listed on the title page is (are) warranted against defects in materials and workmanship for three years from the date of shipment.

ANRITSU's obligation covers repairing or replacing products which prove to be defective during the warranty period. Buyers shall prepay transportation charges for equipment returned to ANRITSU for warranty repairs. Obligation is limited to the original purchaser. ANRITSU is not liable for consequential damages.

### **LIMITATION OF WARRANTY**

The foregoing warranty does not apply to ANRITSU connectors that have failed due to normal wear. Also, the warranty does not apply to defects resulting from improper or inadequate maintenance by the Buyer, unauthorized modification or misuse, or operation outside of the environmental specifications of the product. No other warranty is expressed or implied, and the remedies provided herein are the Buyer's sole and exclusive remedies.

### **TRADEMARK ACKNOWLEDGEMENTS**

V Connector and K Connector are registered trademarks of ANRITSU Company.

GPC-7 is a registered trademark of Amphenol Corporation.

ANACAT is a registered trademark of EEsof, Inc.

QuietJet and ThinkJet are registered trademarks of Hewlett-Packard Co.

Microsoft, Excel, and MS-DOS are registered trademarks of Microsoft Corporation.

Acrobat and Acrobat Reader are trademarks of Adobe Corporation.

Iomega and Zip are registered trademarks of Iomega Company.

### **NOTICE**

ANRITSU Company has prepared this manual for use by ANRITSU Company personnel and customers as a guide for the proper installation, operation and maintenance of ANRITSU Company equipment and computer programs. The drawings, specifications, and information contained herein are the property of ANRITSU Company, and any unauthorized use or disclosure of these drawings, specifications, and information is prohibited; they shall not be reproduced, copied, or used in whole or in part as the basis for manufacture or sale of the equipment or software programs without the prior written consent of ANRITSU Company.

### **UPDATES**

Updates to this manual, if any, may be downloaded from the Anritsu Internet site at:

<http://www.us.anritsu.com>.

# DECLARATION OF CONFORMITY

**Manufacturer's Name:** ANRITSU COMPANY

**Manufacturer's Address:** Microwave Measurements Division  
490 Jarvis Drive  
Morgan Hill, CA 95037-2809  
USA

declares that the product specified below:

**Product Name:** Vector Network Analyzer

**Model Number:** 37247D,37269D,37277D,37297D,37347D,37369D,37377D,37397D

conforms to the requirement of:

EMC Directive 89/336/EEC as amended by Council Directive 92/31/EEC & 93/68/EEC  
Low Voltage Directive 73/23/EEC as amended by Council directive 93/68/EEC

## **Electromagnetic Interference:**

Emissions: CISPR 11:1990/EN55011:1991 Group 1 Class A

Immunity: EN 61000-4-2:1995/EN50082-1:1997 - 4kV CD, 8kV AD  
EN 61000-4-3:1997/EN50082-1:1997 - 3V/m  
ENV 50204/EN50082-1:1997 - 3V/m  
EN 61000-4-4:1995/EN50082-1:1997 - 0.5kV SL, 1kV PL  
EN 61000-4-5:1995/EN50082-1:1997 - 1kV L-L, 2kV L-E  
EN 61000-4-6:1994/EN61326: 1998 - 3V  
EN 61000-4-11:1994/EN61326: 1998 - 1 cycle@100%

## **Electrical Safety Requirement:**

Product Safety: EN 61010-1:2001

  
Corporate Quality Director

Morgan Hill, CA

30 Sept 2004  
Date

European Contact: For Anritsu product EMC & LVD information, contact Anritsu LTD, Rutherford Close,  
Stevenage Herts, SG1 2EF UK, (FAX 44-1438-740202)

# DECLARATION OF CONFORMITY

**Manufacturer's Name:** ANRITSU COMPANY

**Manufacturer's Address:** Microwave Measurements Division  
490 Jarvis Drive  
Morgan Hill, CA 95037-2809  
USA

declares that the product specified below:

**Product Name:** Broadband System

**Model Number:** ME7808A

conforms to the requirement of:

EMC Directive 89/336/EEC as amended by Council Directive 92/31/EEC & 93/68/EEC  
Low Voltage Directive 73/23/EEC as amended by Council directive 93/68/EEC

## **Electromagnetic Interference:**

Emissions: CISPR 11:1990/EN55011: 1991 Group 1 Class A  
EN 61000-3-2:1995 Class A  
EN 61000-3-3:1995 Class A

Immunity: EN 61000-4-2:1995/EN50082-1: 1997 - 4kV CD, 8kV AD  
EN 61000-4-3:1997/EN50082-1: 1997 - 3V/m  
ENV 50204/EN50082-1: 1997 - 3V/m  
EN 61000-4-4:1995/EN50082-1: 1997 - 0.5kV SL, 1kV PL  
EN 61000-4-5:1995/EN50082-1: 1997 - 1kV L-L, 2kV L-E  
EN 61000-4-6:1994/EN61326: 1998 - 3V  
EN 61000-4-11:1994/EN61326: 1998 - 100% @ 20msec

## **Electrical Safety Requirement:**

Product Safety: IEC 1010-1:1990 + A1/EN61010-1: 1993

  
\_\_\_\_\_  
Director of Corporate Quality

Morgan Hill, CA

10-DEC-01  
Date

European Contact: For Anritsu product EMC & LVD information, contact Anritsu LTD, Rutherford Close,  
Stevenage Herts, SG1 2EF UK, (FAX 44-1438-740202)

产品中有毒有害物质或元素的名称及含量

For Chinese Customers Only YLNB

部件名称	有毒有害物质或元素					
	铅 (Pb)	汞 (Hg)	镉 (Cd)	六价铬 [Cr(VI)]	多溴联苯 (PBB)	多溴二苯醚 (PBDE)
印刷电路板 (PCA)	×	○	×	×	○	○
机壳、支架 (Chassis)	×	○	×	×	○	○
LCD	×	×	×	×	○	○
其他(电缆、风扇、 连接器等) (Appended goods)	×	○	×	×	○	○

○：表示该有毒有害物质在该部件所有均质材料中的含量均在 SJ/T11363-2006 标准规定的限量要求以下。  
 ×：表示该有毒有害物质至少在该部件的某一均质材料中的含量超出 SJ/T11363-2006 标准规定的限量要求。

环保使用期限



这个标记是根据 2006/2/28 公布的「电子信息产品污染控制管理办法」以及 SJ/T 11364-2006 「电子信息产品污染控制标识要求」的规定，适用于在中国销售的电子信息产品的环保使用期限。仅限于在遵守该产品的安全规范及使用注意事项的基础上，从生产日起算的该年限内，不会因产品所含有害物质的泄漏或突发性变异，而对环境污染，人身及财产产生深刻地影响。

注) 生产日期标于产品序号的前四码(如 S/N 0728XXXX 为 07 年第 28 周生产)。



# Safety Symbols

To prevent the risk of personal injury or loss related to equipment malfunction, Anritsu Company uses the following symbols to indicate safety-related information. For your own safety, please read the information carefully BEFORE operating the equipment.

## Symbols used in manuals

DANGER	This indicates a very dangerous procedure that could result in serious injury or death if not performed properly.
WARNING	This indicates a hazardous procedure that could result in serious injury or death if not performed properly.
CAUTION	This indicates a hazardous procedure or danger that could result in light-to-severe injury, or loss related to equipment malfunction, if proper precautions are not taken.

## Safety Symbols Used on Equipment and in Manuals

Some or all of the following five symbols may or may not be used on all Anritsu equipment. In addition, there may be other labels attached to products that are not shown in the diagrams in this manual.

The following safety symbols are used inside or on the equipment near operation locations to provide information about safety items and operation precautions. Ensure that you clearly understand the meanings of the symbols and take the necessary precautions BEFORE operating the equipment.



This indicates a prohibited operation. The prohibited operation is indicated symbolically in or near the barred circle.



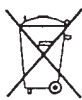
This indicates a compulsory safety precaution. The required operation is indicated symbolically in or near the circle.



This indicates warning or caution. The contents are indicated symbolically in or near the triangle.



This indicates a note. The contents are described in the box.



These indicate that the marked part should be recycled.

---

# For Safety

---

WARNING



Always refer to the operation manual when working near locations at which the alert mark, shown on the left, is attached. If the operation, etc., is performed without heeding the advice in the operation manual, there is a risk of personal injury. In addition, the equipment performance may be reduced.

Moreover, this alert mark is sometimes used with other marks and descriptions indicating other dangers.

WARNING



When supplying power to this equipment, connect the accessory 3-pin power cord to a 3-pin grounded outlet. If a grounded 3-pin outlet is not available, use a conversion adapter and ground the green wire, or connect the frame ground on the rear panel of the equipment to ground. If power is supplied without grounding the equipment, there is a risk of receiving a severe or fatal electric shock.

WARNING

Repair



This equipment can not be repaired by the operator. DO NOT attempt to remove the equipment covers or to disassemble internal components. Only qualified service technicians with a knowledge of electrical fire and shock hazards should service this equipment. There are high-voltage parts in this equipment presenting a risk of severe injury or fatal electric shock to untrained personnel. In addition, there is a risk of damage to precision components.

WARNING



Use two or more people to lift and move this equipment, or use an equipment cart. There is a risk of back injury, if this equipment is lifted by one person.



# *Narrative Table Of Contents*

---

## **Chapter 1—General Information**

This chapter provides a general description of the Anritsu Model 37XXXD Vector Network Analyzer System and its major units: network analyzer, test set, and frequency source. It also provides descriptions for the precision component kits, and equipment options. Additionally, it contains the listing of recommended test equipment.

## **Chapter 2—Installation**

This chapter provides instructions for performing an initial inspection, preparing the equipment for use, setting up for operation over the IEEE-488.2 (GPIB) Bus, using a printer, and preparing the units for storage and/or shipment. It also provides a listing of Anritsu Customer Service Centers.

## **Chapter 3—Network Analyzers, A Primer**

This chapter provides an introduction to network analysis and the types of measurements that can be made using them. It provides general and introductory description.

## **Chapter 4—Front Panel Operation**

This chapter describes the front panel controls and provides flow diagrams for the menus called up using the front panel controls. It contains the following sub-chapters:

- Front Panel Control-Group Descriptions
- Calibration Keys and Indicators, Detailed Description
- Save/Recall Menu Key and Menus, Key Description and Menu Flow
- Measurement Keys and Menus, Key Descriptions and Menu Flow
- Channel Keys and Menu, Key Descriptions and Menu Flow
- Display Keys and Menus, Key Descriptions and Menu Flow
- Enhancement Keys and Menus, Key Descriptions and Menu Flow
- Hard Copy Keys and Menus, Key Descriptions and Menu Flow
- System State Keys and Menus, Key Descriptions and Menu Flow
- Markers/limits Keys and Menus, Key Descriptions and Menu Flow
- Disk Storage Interface, Detailed Description

## **Chapter 5—Error And Status Messages**

This chapter describes the type of error messages you may encounter during operation and provides a tabular listing. This listing describes and defines the error types.

## **Chapter 6—Data Displays**

This chapter provides a detailed description of the various data displays. It describes the graph types, frequency markers, measurement limit lines, status displays, and data display controls.

## ***Narrative Table of Contents (Continued)***

---

### **Chapter 7—Measurement Calibration**

This chapter provides a discussion and tutorial on measurement calibration. It contains step-by-step calibration procedures for the Standard (OSL), Offset-Short, TRM, and LRL/LRM methods. It also has a procedure for calibrating using a sliding termination.

### **Chapter 8—Measurements**

This chapter discusses measurements with the 37XXXD VNA. It contains sub-chapters that provide a detailed descriptions for Transmission and Reflection, Low Level and Gain, Group Delay, Active Device, Multiple Source Control, Adapter Removal, Gain Compression, and Receiver Mode measurements

### **Chapter 9—Time Domain**

This chapter describes the Option 2, Time Domain feature. It provides an operational procedure and a flowchart of the time domain menus.

### **Chapter 10—AutoCal**

This chapter describes the Automatic Calibrator (AutoCal) feature and provides operational information and procedures.

### **Chapter 11—Operational Checkout Procedures**

This chapter provides a procedure for operational checkout

### **Chapter 12—Calibration Kits**

This chapter provides a description and listing of components for the calibration kits.

### **Chapter 13—Millimeter Wave System**

This chapter contains description, operation, and checkout procedures for the millimeter wave measurement capability that can be added to the 371XXD Vector Network Analyzer.

### **Chapter 14—ME7808C Broadband Measurement System**

This chapter contains description, operation, and checkout procedures for the optional broadband measurement capability that can be added to the 37XXXD Vector Network Analyzer.

### **Appendix A—Front Panel Menus, Alphabetical Listing**

This appendix shows all of the menus that are called up using the front panel controls. It provides a replica of the menu and descriptive text for all of the various menu choices. The listing is alphabetical by the menu call letters mentioned and/or illustrated in Chapter 4.

### **Appendix B—Model 37XXXD VNA Rear Panel Connectors**

This appendix describes the rear panel connectors. It also provides pinout listing.

### **Appendix C—Performance Specifications**

This appendix contains the Technical Data Sheet, part number 11410-00350, which provides performance specifications.

### **Index**

# Table of Contents

---

## **Chapter 1 General Information**

- 1-1 SCOPE OF MANUAL . . . . . 1-3
- 1-2 INTRODUCTION . . . . . 1-3
- 1-3 IDENTIFICATION NUMBER. . . . . 1-3
- 1-4 ONLINE MANUALS. . . . . 1-3
- 1-5 SYSTEM DESCRIPTION . . . . . 1-3
  - 372XXD . . . . . 1-4
  - 373XXD . . . . . 1-4
- 1-6 MILLIMETER WAVE MEASUREMENTS . . . . . 1-4
- 1-7 PRECISION COMPONENT KITS . . . . . 1-4
  - Model 3650 SMA/3.5 mm Calibration Kit . . . . . 1-5
  - Model 3651 GPC-7 Calibration Kit . . . . . 1-6
  - Model 3652 K Connector Calibration Kit . . . . . 1-7
  - Model 3653 Type N Calibration Kit . . . . . 1-8
  - Model 3654C V Connector® Calibration Kit. . . . . 1-9
  - Model 3656 W1 Connector Calibration Kit . . . . . 1-10
  - Model 3657 Multiple Line Calibration Kit . . . . . 1-11
  - Model 3666 3.5 mm Verification Kit . . . . . 1-12
  - Model 3667 GPC-7 Verification Kit. . . . . 1-13
  - Model 3668 K Connector® Verification Kit. . . . . 1-14
  - Model 3669/3669B V Connector® Verification Kits . . . . . 1-15
- 1-8 OPTIONS . . . . . 1-16
- 1-9 PERFORMANCE SPECIFICATIONS. . . . . 1-16
- 1-10 PREVENTIVE MAINTENANCE . . . . . 1-16

## **Chapter 2 Installation**

- 2-1 INTRODUCTION . . . . . 2-3
- 2-2 INITIAL INSPECTION . . . . . 2-3
- 2-3 PREPARATION FOR USE . . . . . 2-3
  - Option 4, External SCSI Drive Setup . . . . . 2-4

## **Table of Contents (Continued)**

---

2-4	GPIB SETUP . . . . .	2-6
	Interface Connector . . . . .	2-6
	Cable Length Restrictions . . . . .	2-6
2-5	SYSTEM GPIB INTERCONNECTION . . . . .	2-7
	GPIB Interface to an External Plotter . . . . .	2-7
	GPIB Addresses . . . . .	2-7
2-6	<b>ETHERNET SETUP AND INTERCONNECTION</b> . . . . .	2-7
2-7	EXTERNAL MONITOR CONNECTOR . . . . .	2-8
2-8	RACK MOUNT . . . . .	2-8
2-9	STORAGE OR SHIPMENT . . . . .	2-11
	Preparation for Storage . . . . .	2-11
	Preparation for Shipment . . . . .	2-11
2-10	SERVICE CENTERS . . . . .	2-12

### **Chapter 3 Network Analyzers, A Primer**

3-1	INTRODUCTION . . . . .	3-3
3-2	GENERAL DESCRIPTION . . . . .	3-3
	Source Module . . . . .	3-4
	Test Set Module . . . . .	3-4
	Analyzer Module . . . . .	3-4
3-3	NETWORK ANALYZERS . . . . .	3-5

### **Chapter 4 Front Panel Operation**

4-1	INTRODUCTION . . . . .	4-3
4-2	KEY-GROUPS . . . . .	4-3
4-3	CALIBRATION KEY-GROUP . . . . .	4-10
4-4	SAVE/RECALL MENU KEY . . . . .	4-20
4-5	MEASUREMENT KEY-GROUP . . . . .	4-21
4-6	CHANNELS KEY-GROUP . . . . .	4-24
4-7	DISPLAY KEY-GROUP . . . . .	4-25
4-8	ENHANCEMENT KEY-GROUP . . . . .	4-29
4-9	HARD COPY KEY-GROUP . . . . .	4-31
4-10	SYSTEM STATE KEY-GROUP . . . . .	4-33
4-11	MARKERS/LIMITS KEY-GROUP . . . . .	4-36

## ***Table of Contents (Continued)***

---

4-12	DISK STORAGE INTERFACE . . . . .	4-40
	Disk Format . . . . .	4-40
	Disk Files. . . . .	4-40
	Disk File Output Device. . . . .	4-41
	Formatting a Data File Disk . . . . .	4-41
	Copying Data Files From Disk to Disk . . . . .	4-41
	Recovering From Disk Write/Read Errors . . . . .	4-41
4-13	COMMAND LINE . . . . .	4-42
	Create Directory . . . . .	4-42
	List Directory . . . . .	4-42
	Change Directory . . . . .	4-42
	Delete Files. . . . .	4-42
	Remove Directory . . . . .	4-43
	Copy Files . . . . .	4-43
	Conventions . . . . .	4-43

### ***Chapter 5 Error and Status Messages***

5-1	INTRODUCTION . . . . .	5-3
5-2	ERROR MESSAGES. . . . .	5-3

### ***Chapter 6 Data Displays***

6-1	INTRODUCTION . . . . .	6-3
6-2	DISPLAY MODES AND TYPES . . . . .	6-3
	Single Channel Display: Ch 1, 2, 3, 4. . . . .	6-3
	Dual Channel Display: Ch 1 and 3 or Ch 2 and 4 . . . . .	6-4
	Four Channel Display: Ch 1, 2, 3, 4 . . . . .	6-5
	Dual Trace Overlay . . . . .	6-6
	Graph Data Types. . . . .	6-7
6-3	FREQUENCY MARKERS . . . . .	6-11
	Marker Designation . . . . .	6-11
6-4	LIMITS . . . . .	6-11

## ***Table of Contents (Continued)***

---

6-5	STATUS DISPLAY . . . . .	6-12
	Reference Position Marker . . . . .	6-12
	Scale Resolution . . . . .	6-12
	Frequency Range . . . . .	6-12
	Analog Instrument Status. . . . .	6-12
	Measurement Status . . . . .	6-13
	Sweep Indicator Marker. . . . .	6-13
6-6	DATA DISPLAY CONTROL . . . . .	6-13
	S-parameter Selection . . . . .	6-14
	Data Display Update . . . . .	6-14
	Display of Markers. . . . .	6-14
6-7	HARD COPY AND DISK OUTPUT . . . . .	6-15
	Tabular Printout . . . . .	6-15
	Screen-Image Printout . . . . .	6-15
	Plotter Output . . . . .	6-15
	Disk Output . . . . .	6-15

## ***Chapter 7 Measurement Calibration***

7-1	INTRODUCTION . . . . .	7-3
7-2	DISCUSSION . . . . .	7-3
	Establishing the Test Ports . . . . .	7-3
	Understanding the Calibration System . . . . .	7-5
	Calibrating for a Measurement . . . . .	7-9
	Evaluating the Calibration . . . . .	7-11
	Verification Kits . . . . .	7-11
7-3	SLIDING TERMINATION . . . . .	7-13
7-4	SOLT CALIBRATION . . . . .	7-19
7-5	OFFSET-SHORT CALIBRATION (SSLT) . . . . .	7-28
7-6	TRIPLE OFFSET-SHORT CALIBRATION (SSST) . . . . .	7-32
7-7	LRL/LRM CALIBRATION . . . . .	7-36
7-8	TRM CALIBRATION. . . . .	7-46
7-9	MERGE CAL FILES APPLICATION . . . . .	7-47

## ***Table of Contents (Continued)***

---

### ***Chapter 8 Measurements***

8-1	INTRODUCTION . . . . .	8-3
8-2	TRANSMISSION AND REFLECTION . . . . .	8-3
8-3	LOW LEVEL AND GAIN . . . . .	8-12
8-5	ACTIVE DEVICE . . . . .	8-24
8-6	MULTIPLE SOURCE CONTROL . . . . .	8-29
	Control Formula . . . . .	8-29
8-7	ADAPTER REMOVAL . . . . .	8-34
8-8	GAIN COMPRESSION. . . . .	8-39
	Power and VNAs. . . . .	8-39
	Swept Power Gain Compression . . . . .	8-41
	Swept Frequency Gain Compression . . . . .	8-41
8-9	RECEIVER MODE . . . . .	8-58
	Source Lock Mode . . . . .	8-58
	Tracking Mode . . . . .	8-58
	Set-on Mode . . . . .	8-58
	Receiver Mode Block Diagram . . . . .	8-59
	Receiver Mode Menus . . . . .	8-59
	Procedure, Receiver Mode Operation . . . . .	8-59
8-10	EMBEDDING/ DE-EMBEDDING. . . . .	8-62
	Embedding . . . . .	8-63
	De-embedding . . . . .	8-64
8-11	OPTICAL APPLICATION . . . . .	8-65
	E/O Measurements . . . . .	8-65
	O/E Measurements . . . . .	8-68
	Creating a Characterization (*.S2P) File for E/O and O/E Measurements . . . . .	8-74

### ***Chapter 9 Time Domain***

9-1	INTRODUCTION . . . . .	9-3
9-2	TIME DOMAIN MEASUREMENTS . . . . .	9-3
9-3	OPERATING TIME DOMAIN . . . . .	9-8
9-4	WINDOWING. . . . .	9-11
9-5	GATING. . . . .	9-12

## ***Table of Contents (Continued)***

---

9-6	ANTI-GATING . . . . .	9-14
9-7	EXAMPLES, GATING AND ANTI-GATING . . . . .	9-14
9-8	TIME DOMAIN MENUS. . . . .	9-14

### ***Chapter 10 AutoCal***

10-1	INTRODUCTION. . . . .	10-3
10-2	DESCRIPTION . . . . .	10-3
10-3	CALIBRATIONS . . . . .	10-4
10-4	DEFINITIONS . . . . .	10-4
10-5	PHYSICAL SETUP. . . . .	10-6
10-6	CHARACTERIZATION FILES . . . . .	10-7
10-7	USING AUTOCAL . . . . .	10-9
10-8	PIN DEPTH SPECIFICATIONS . . . . .	10-13
10-9	AUTOCAL MENUS FLOW DIAGRAM . . . . .	10-14

### ***Chapter 11 Operational Checkout Procedures***

11-1	INTRODUCTION. . . . .	11-3
11-2	REQUIRED EQUIPMENT. . . . .	11-3
11-3	INITIAL SETUP . . . . .	11-3
11-4	SELF TEST . . . . .	11-3
11-5	NON-RATIO POWER . . . . .	11-4
11-6	HIGH LEVEL NOISE TEST. . . . .	11-6

### ***Chapter 12 Calibration Kits***

12-1	INTRODUCTION. . . . .	12-3
12-2	PURPOSE. . . . .	12-3
12-3	KIT CONTENTS . . . . .	12-3
	Model 3650 Calibration Kit . . . . .	12-4
	Model 3651 Calibration Kit . . . . .	12-5
	Model 3652 Calibration Kit . . . . .	12-6
	Model 3653 Calibration Kit . . . . .	12-7
	Model 3654C Calibration Kit . . . . .	12-8
	Model 3656 Calibration Kit . . . . .	12-9
	Model 3657 Calibration Kit . . . . .	12-10



## ***Table of Contents (Continued)***

---

12-4	PRECAUTIONS . . . . .	12-11
	Pin Depth . . . . .	12-11
	Pin Depth Tolerance . . . . .	12-12
	Over Torquing Connectors . . . . .	12-12
	Teflon Tuning Washers. . . . .	12-12
	Mechanical Shock . . . . .	12-12
12-5	CLEANING INSTRUCTIONS . . . . .	12-13

### ***Chapter 13 Millimeter Wave System***

13-1	INTRODUCTION. . . . .	13-3
13-2	DESCRIPTION . . . . .	13-3
13-3	PERFORMANCE SPECIFICATIONS. . . . .	13-4
	System Performance . . . . .	13-4
	Test Port Characteristics . . . . .	13-5
	Measurement Capabilities . . . . .	13-5
13-4	INSTALLATION . . . . .	13-6
	Console and Table Setup . . . . .	13-7
	Instrument Installation into Console. . . . .	13-8
	System Cabling. . . . .	13-10
13-5	CALIBRATION . . . . .	13-12
13-6	OPERATION . . . . .	13-13
	Entering/ Leaving Millimeter Wave Operation . . . . .	13-13
	Changing Bands/Modules While in Millimeter Wave. . . . .	13-17
	Allowable Millimeter Wave Module Configurations, Measurements and Calibrations. . . . .	13-17
	Effect of Default Program . . . . .	13-18
	Redefinition of Band Frequency Ranges . . . . .	13-19
	Use of Normal Multiple Source Mode . . . . .	13-20
	Stored Setups and Calibrations . . . . .	13-20
	External Source and Power Levels . . . . .	13-21
13-7	MEASUREMENT PROCEDURE. . . . .	13-22
13-8	REMOTE OPERATION. . . . .	13-23
13-9	OPERATIONAL CHECKOUT— GENERAL . . . . .	13-24
13-10	OPERATION CHECKOUT—IF POWER LEVEL TEST . . . . .	13-25
13-11	OPERATIONAL CHECKOUT— TRANSMISSION HIGH LEVEL NOISE TEST	13-27

## ***Table of Contents (Continued)***

---

13-12 OPERATIONAL CHECKOUT— REFLECTION HIGH LEVEL NOISE TEST . 13-29

### ***Chapter 14 ME7808C Broadband Measurement System***

14-1	INTRODUCTION. . . . .	14-3
14-2	SYSTEM DESCRIPTION . . . . .	14-4
	Measurement Instruments . . . . .	14-4
	Console and Associated Hardware . . . . .	14-4
	Cables . . . . .	14-4
14-3	INSTALLATION . . . . .	14-5
	Console and Table Setup . . . . .	14-6
	Instrument Installation into Console. . . . .	14-7
	System Cabling . . . . .	14-9
14-4	INITIAL ELECTRICAL TESTS . . . . .	14-11
	Millimeter Module Checkout. . . . .	14-11
	40 MHz to 65 GHz Checkout. . . . .	14-12
14-5	WAFER PROBE STATION . . . . .	14-13
14-6	BROADBAND MENUS, FLOW. . . . .	14-15
14-7	BROADBAND CALIBRATION. . . . .	14-16
	Merging Calibrations. . . . .	14-16

### ***Appendix A Front Panel Menus, Alphabetical Listing***

### ***Appendix B Rear Panel Connectors***

### ***Appendix C Performance Specifications***

### ***Subject Index***

# **Chapter 1**

## **General Information**

### **Table of Contents**

---

1-1	SCOPE OF MANUAL . . . . .	1-3
1-2	INTRODUCTION . . . . .	1-3
1-3	IDENTIFICATION NUMBER. . . . .	1-3
1-4	ONLINE MANUALS. . . . .	1-3
1-5	SYSTEM DESCRIPTION . . . . .	1-3
	372XXD . . . . .	1-4
	373XXD . . . . .	1-4
1-6	MILLIMETER WAVE MEASUREMENTS . . . . .	1-4
1-7	PRECISION COMPONENT KITS . . . . .	1-4
	Model 3650 SMA/3.5 mm Calibration Kit . . . . .	1-5
	Model 3651 GPC-7 Calibration Kit . . . . .	1-6
	Model 3652 K Connector Calibration Kit . . . . .	1-7
	Model 3653 Type N Calibration Kit . . . . .	1-8
	Model 3654C V Connector® Calibration Kit. . . . .	1-9
	Model 3656 W1 Connector Calibration Kit. . . . .	1-10
	Model 3657 Multiple Line Calibration Kit . . . . .	1-11
	Model 3666 3.5 mm Verification Kit . . . . .	1-12
	Model 3667 GPC-7 Verification Kit. . . . .	1-13
	Model 3668 K Connector® Verification Kit. . . . .	1-14
	Model 3669/3669B V Connector® Verification Kits . . . . .	1-15
1-8	OPTIONS . . . . .	1-15
1-9	PERFORMANCE SPECIFICATIONS. . . . .	1-15
1-10	PREVENTIVE MAINTENANCE . . . . .	1-15



**Figure 1-1.** Model 37397D Vector Network Analyzer System

# Chapter 1

## General Information

### **1-1** SCOPE OF MANUAL

This manual provides general information, installation, and operating information for the Model 37XXXD Vector Network Analyzer (VNA) system. (Throughout this manual, the terms VNA, 37XXXD VNA, and 37XXXD will be used interchangeably to refer to the system.)

### **1-2** INTRODUCTION

This section provides general information about the 37XXXD VNA system and one or more precision-component calibration or performance verification kits. The section also provides a listing of recommended test equipment.

### **1-3** IDENTIFICATION NUMBER

All Anritsu instruments are assigned a unique six-digit ID number, such as “940101.” This number is affixed to a decal on the rear panel of each unit. In any correspondence with Anritsu Customer Service, please use this number.

### **1-4** ONLINE MANUALS

Manual updates, if any, are available on Anritsu's Internet download page (<http://www.us.anritsu.com/downloads/>).

### **1-5** SYSTEM DESCRIPTION

The 37XXXD Network Analyzer (Figure 1-1) is a single-instrument system that contains a built-in source, test set, and analyzer. It is produced in two series— 372XXD and 373XXD—described below. All models provide up to 1601 measurement data points, a built-in hard-disk drive for storing and recalling front panel setups and measurement and calibration data. They also provide an on-screen display of total operational time and dates of system calibrations. They support operation over the IEEE 488.2 General Purpose Interface Bus (GPIB).

**372XXD**

The 372XXD is a fully functioning VNA for making passive-device measurements. The series offers five models that cover a range from 22.5 MHz to 65 GHz. The models are shown below:

Model	Frequency Range
37247D	40.0 MHz to 20.0 GHz
37269D	40.0 MHz to 40.0 GHz
37277D	40.0 MHz to 50.0 GHz
37297D	40.0 MHz to 65.0 GHz

**373XXD**

The 373XXD is a fully functioning VNA for making passive- and active-device measurements. The series offers five models that cover a range from 22.5 MHz to 65 GHz. The models are shown below.

Model	Frequency Range
37347D	40.0 MHz to 20.0 GHz
37369D	40.0 MHz to 40.0 GHz
37377D	40.0 MHz to 50.0 GHz
37397D	40.0 MHz to 65.0 GHz

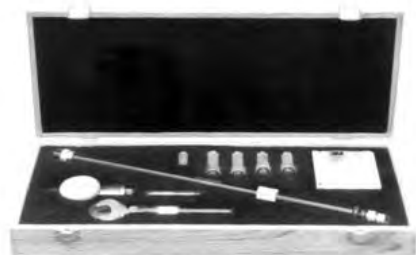
**1-6** **MILLIMETER WAVE MEASUREMENTS**

Any 37XXXD VNA can be used for making millimeter-wave measurements using the rear panel IF inputs. A description of this measurement mode is described in Chapter 13.

**1-7** **PRECISION COMPONENT KITS**

Two types of precision-component kits are available: calibration and verification. Calibration kits contain components used to identify and separate error sources inherent in microwave test setups. Verification kits consist of components with characteristics traceable to the National Institute of Standards and Technology (NIST). This type of kit is usually kept in the metrology laboratory where it provides the most dependable means of checking system accuracy. Each of these kits contains a micro-floppy disk providing coefficient or measurement data for each component. Details of these kits are described in the following paragraphs.

**Model 3650 SMA/3.5 mm  
Calibration Kit**

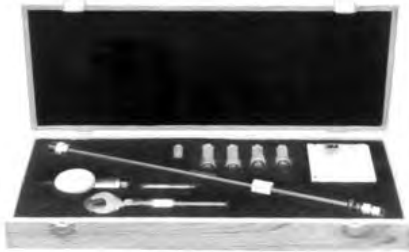


**Figure 1-2.** Typical Model 365X  
Calibration Kit

The 3650 Calibration Kit (Figure 1-2) contains all the precision components and tools required to calibrate the 37XXXD VNA for 12-term error-corrected measurements of test devices with SMA or 3.5 mm connectors. Components are included for calibrating both male and female test ports. The kit supports calibration with broadband loads. The kit consists of the following components:

- 23S50 Short, SMA/3.5 mm Male
- 23SF50 Short, SMA/3.5 mm Female
- 24S50 Open, SMA/3.5 mm Male
- 24SF50 Open, SMA/3.5 mm Female
- 28S50-2 Termination, SMA/3.5 mm Male, 2 ea. (dc-26.5 GHz)
- 28SF50-2 Termination, SMA/3.5 mm Female, 2 ea. (dc-26.5 GHz)
- 33SFSF50 Insertable, SMA/3.5 mm Female/Female, 2 ea.
- 33SS50 Insertable, SMA/3.5 mm Male/Male
- 33SSF50 Insertable, SMA/3.5 mm Male/Female, 2 ea.
- 34AS50-2 Adapter, GPC-7 to SMA/3.5 mm Male, 2 ea.
- 34ASF50-2 Adapter, GPC-7 to SMA/3.5 mm Female, 2 ea.
- 01-201 Torque Wrench
- 01-210 Reference Flat
- 01-222 Connector Gauge
- 01-223 Gauge Kit Adapter
- Data Disk

**Option 1:** Adds 17S50 Sliding Load, SMA/3.5 mm Male; 17SF50 Sliding Load, SMA/3.5 mm Female; 01-211 Female Flush Short; and 01-212 Male Flush Short.

**Model 3651 GPC-7  
Calibration Kit**

**Figure 1-3.** Typical Model 365X  
Calibration Kit

The 3651 Calibration Kit (Figure 1-3) contains all the precision components and tools required to calibrate the 37XXXD for 12-term error-corrected measurements of test devices with GPC-7 connectors. The kit supports calibration with broadband loads. Option 1 adds a sliding load and a pin depth gauge.

The kit consists of the following components:

- 23A50 Short, GPC-7
- 24A50 Open, GPC-7
- 28A50-2 Termination, GPC-7, 2 ea. (dc-18 GHz)
- 01-200 Torque Wrench
- 01-221 Collet Extractor Tool and Vial of Four Collets
- Data Disk

**Option 1 Adds:**

- 17A50 Sliding Load, GPC-7
- 01-220 GPCP-7 Connector Gauge
- 01-210 Reference Flat Model 3652 K Connector® Calibration Kit



### **Model 3652 K Connector Calibration Kit**



**Figure 1-4.** Typical Model 365X  
Calibration Kit

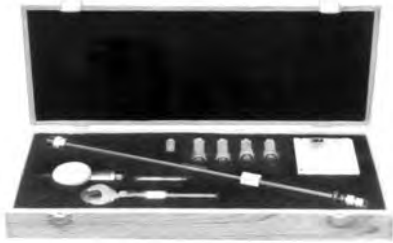
The 3652 Calibration Kit (Figure 1-4) contains all the precision components and tools required to calibrate the 37XXXD for 12-term error-corrected measurements of test devices with K Connectors. Components are included for calibrating both male and female test ports. The kit supports calibration with broadband loads. Option 1 adds sliding loads.

The kit consists of the following components:

- 23K50 Short, K Male
- 23KF50 Short, K Female
- 24K50 Open, K Male
- 24KF50 Open, K Female
- 28K50 Termination, K Male, 2 ea. (dc–40 GHz)
- 28KF50 Termination, K Female, 2 ea. (dc–40 GHz)
- 33KK50 Insertable, K Male/Male
- 33KFKF50 Insertable K Female/Female, 2 ea
- 33KKF50 Insertable, K Male/Female, 2 ea
- 34AK50 Adapter, GPC–7/K Male, 2 ea
- 34AKF50 Adapter, GPC–7/K Female, 2 ea
- 01–201 Torque Wrench
- 01–210 Reference Flat
- 01–222 Connector Gauge
- 01–223 Gauge Kit Adapter
- Data Disk

#### **Option 1 Adds:**

- 17K50 Sliding Load, K Male
- 17KF50 Sliding Load, K Female
- 01–211 Female Flush Short
- 01–212 Male Flush Short.

**Model 3653 Type N  
Calibration Kit**

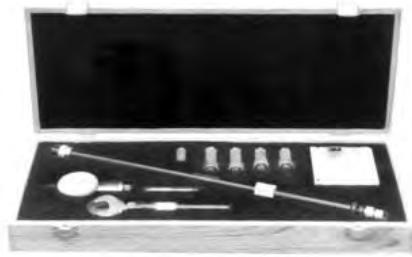
**Figure 1-5.** Typical Model 365X  
Calibration Kit

The 3653 Calibration Kit (Figure 1-5) contains all the precision components and tools required to calibrate the 37XXXD for 12-term error-corrected measurements of test devices with Type N connectors. Components are included for calibrating both male and female test ports. The kit supports calibration with broadband loads. Option 1 for sliding loads is not available in this calibration kit.

The kit consists of the following components:

- 23N50 Short, N Male
- 23NF50 Short, N Female
- 24N50 Open, N Male
- 24NF50 Open, N Female
- 28N50-2 Termination, N Male, 2 ea. (dc-18 GHz)
- 28NF50-2 Termination, N Female, 2 ea. (dc-18 GHz)
- 34AN50-2 Adapter, GPC-7/N Male, 2 ea.
- 34ANF50-2 Adapter, GPC-7/N Female, 2 ea.
- 01-213 Type N Reference Gauge
- 01-224 Type N Connector Gauge
- Data Disk Model 3654B

**Model 3654C  
V Connector® Calibration  
Kit**



**Figure 1-6.** Typical Model 365X Calibration Kit

The 3654C Calibration Kit (Figure 1-6) contains all the precision components and tools required to calibrate the 372XXD for 12-term error-corrected measurements of test devices with V Connectors. Components are included for calibrating both male and female test ports.

The kit consists of the following components:

- 17VF50B Female Sliding Termination
- 17V50B Male Sliding Termination
- 33VVF50 Male-Female Adapter (2)
- Calibration Software, 2360-54B
- 28V50B Male and 28VF50B Female Broadband Terminations (2 ea.)
- 24V50B Male and 24VF50B Female Opens
- 23V50B-5.1 Male and 23VF50B-5.1 Female Shorts 5.1mm
- 33VV50 Male-Male Adapter
- 33VVFV50 Female-Female Adapter (2)
- Connector Thumb Wheel (4)
- 01-201 Torque Wrench
- 01-323 Female Adapter for Pin Gauge
- 01-322 Pin Depth Gauge
- 01-210 Reference Flat, 01-204 Adapter Wrench
- 01-312 Male Flush Short
- 01-311 Female Flush Short

**Model 3656 W1 Connector  
Calibration Kit**



**Figure 1-7.** 3656 (W1) Calibration Kit

The 3656 W1 (1.0 mm) Connector Calibration Kit (Figure 1-7) consists of precision components to calibrate the VNA to 110 GHz. The kit supports SOLT calibrations with opens, shorts, and loads to 65 GHz, and Triple Offset short calibrations from 65 GHz to 110 GHz. The kit also includes verification devices for determining system accuracy of the VNA. A diskette containing factory measured test data is supplied for comparison with customer measured data.

- 23W50-1, Male Offset Short 2.02 mm
- 23WF50-1, Female Offset Short 2.02 mm
- 23W50-2, Male Offset Short 2.65 mm
- 23WF50-2, Female Offset Short 2.65 mm
- 23W50-3, Male Offset Short 3.180 mm
- 23WF50-3, Female Offset Short 3.180 mm
- 24W50, Male Open 1.510 mm
- 24WF50, Female Open 1.930 mm
- 28W50, Male Broadband Termination
- 28WF50, Female Broadband Termination
- 33WW50, Male-Male Adapter (1)
- 33WWF50, Male-Female Adapter (1)
- 33WFWF50, Female-Female Adapter (1)
- 01-401, Interchangeable Adapter Fixed Female
- 01-402, Interchangeable Adapter Fixed Male
- 18WWF50-1, 50 Matched ThruLine (Verification Device)
- 18WWF50-1B, Stepped Impedance ThruLine (Verification Device)
- 01-504, Torque Wrench
- 01-505, End Wrench
- Calibration coefficients diskette
- Verification kit diskette

**Model 3657 Multiple Line Calibration Kit**

**Figure 1-8.** 3657 Multiple Line Calibration Kit

The 3657 Multiple Line Calibration Kit (Figure 1-8) consists of precision components to calibrate the VNA to 110 GHz. The kit includes verification devices for determining system accuracy of the VNA.

- ❑ 65898-1, 15.00 mm V-LRL Male-Male, Outer Conductor
- ❑ 65899-1, 15.00 mm V-LRL Male-Male, Center Conductor
- ❑ 65898-2, 16.70 mm V-LRL Male-Male, Outer Conductor
- ❑ 65899-2, 16.70 mm V-LRL Male-Male, Center Conductor
- ❑ 65898-3, 18.40 mm V-LRL Male-Male, Outer Conductor
- ❑ 65899-3, 18.40 mm V-LRL Male-Male, Center Conductor
- ❑ 65898-4, 20.10 mm V-LRL Male-Male, Outer Conductor
- ❑ 65899-4, 20.10 mm V-LRL Male-Male, Center Conductor
- ❑ 65898-5, 21.80 mm V-LRL Male-Male, Outer Conductor
- ❑ 65899-5, 21.80 mm V-LRL Male-Male, Center Conductor
- ❑ 65898-6, 49.84 mm V-LRL Male-Male, Outer Conductor
- ❑ 65899-6, 49.84 mm V-LRL Male-Male, Center Conductor
- ❑ 23V50B-5.1, 5.1 mm Male Short (3651-1 Only) (2)
- ❑ 23VF50B-5.1, 5.1 mm Female Short (3651-1 Only) (2)
- ❑ 65922, Center Conductor Removal Plug
- ❑ 65901-1, Center Conductor Installation/Removal Fixture
- ❑ 65901-6, Center Conductor Installation/Removal Fixture
- ❑ 783-1243, End Wrench, 7 mm
- ❑ 01-201, Torque Wrench, 8 in-lbs.

**Model 3666 3.5 mm  
Verification Kit**

**Figure 1-9.** Typical Model 366X  
Verification Kit

The 3666 Verification Kit (Figure 1-9) contains precision 3.5 mm components with characteristics that are traceable to the NIST. Used primarily by the metrology laboratory, these components provide the most dependable means of determining system accuracy. A disk containing factory-measured test data for all components is supplied for comparison with customer-measured data.

The 3666 consists of the following components:

- 19S50-7 7.5 cm Air Line
- 19S50-7B 7.5 cm Stepped Impedance Air Line (Beatty Standard)
- 42S-20 20 dB Attenuator
- 42S-50 50 dB Attenuator

**Model 3667 GPC-7  
Verification Kit**

**Figure 1-10.** Typical Model 366X  
Verification Kit

The 3667 Verification Kit (Figure 1-10) contains precision GPC-7 components with characteristics that are traceable to the NIST. Used primarily by the metrology laboratory, these components provide the most dependable means of determining system accuracy. A disk containing factory-measured test data for each component is supplied for comparison with customer-measured data.

The kit consists of the following components:

- 18A50-10B 10 cm Stepped Impedance Air Line (Beatty Standard)
- 18A50-10 10 cm Air Line
- 42A-20 20 dB Attenuator
- 42A-50 50 dB Attenuator

**Model 3668  
K Connector® Verification  
Kit**



**Figure 1-11.** Typical Model 366X  
Verification Kit

The 3668 Verification Kit (Figure 1-11) contains precision K Connector components with characteristics that are traceable to the NIST. Used primarily by the metrology laboratory, these components provide the most dependable means of determining system accuracy. A disk containing factory-measured test data for each component is supplied for comparison with customer-measured data.

The kit consists of the following components:

- 19K50-7 7.5 cm Air Line
- 19K50-7B 7.5 cm Stepped Impedance Air Line (Beatty Standard)
- 42K-20 20 dB Attenuator
- 42K-50 50 dB Attenuator



**Model 3669/3669B  
V Connector® Verification  
Kits**



**Figure 1-12.** Typical Model 366X  
Verification Kit

The 3669 and 3669B Verification Kits (Figure 1-12) contain precision V Connector components with characteristics that are traceable to the NIST. Used primarily by the metrology laboratory, these components provide the most dependable means of determining system accuracy. A disk containing factory-measured test data for each component is supplied for comparison with customer-measured data.

The kit consists of the following components:

- 19-V50-5 5 cm Air Line
- 19V50-5B 5 cm Stepped Impedance Air Line (Beatty Standard)
- 42V-20 20 dB Attenuator
- 42V-40 40 dB Attenuator

**1-8** **OPTIONS**

The following options are available:

- Option 1: Rack Mount Kit
- Option 2: Time (Distance) Domain Measurement Capability
- Option 4: External SCSI Hard Drive Interface
- Option 15: Flexible test set (provides access to all four samplers and Source loops for each port)

**1-9** **PERFORMANCE  
SPECIFICATIONS**

System performance specifications are provided in Appendix C.

**1-10** **PREVENTIVE  
MAINTENANCE**

The 37XXXD VNA system does not require any preventive maintenance.

# **Chapter 2**

## **Installation**

### **Table of Contents**

---

2-1	INTRODUCTION . . . . .	2-3
2-2	INITIAL INSPECTION . . . . .	2-3
2-3	PREPARATION FOR USE . . . . .	2-3
	Option 4, External SCSI Drive Setup . . . . .	2-4
2-4	GPIB SETUP . . . . .	2-5
	Interface Connector . . . . .	2-5
	Cable Length Restrictions . . . . .	2-5
2-5	SYSTEM GPIB INTERCONNECTION. . . . .	2-6
	GPIB Interface to an External Plotter . . . . .	2-6
	GPIB Addresses . . . . .	2-6
2-6	ETHERNET SETUP AND INTERCONNECTION. . . . .	2-6
2-7	EXTERNAL MONITOR CONNECTOR . . . . .	2-7
2-8	RACK MOUNT. . . . .	2-7
2-9	STORAGE OR SHIPMENT . . . . .	2-10
	Preparation for Storage . . . . .	2-10
	Preparation for Shipment . . . . .	2-10
2-10	SERVICE CENTERS. . . . .	2-11



# Chapter 2

## Installation

### 2-1 INTRODUCTION

This chapter provides information for the initial inspection and preparation for use of the 37XXXD Vector Network Analyzer. Information for interfacing the 37XXXD to the IEEE-488 General Purpose Interface Bus and reshipment and storage information is also included.

### 2-2 INITIAL INSPECTION

Inspect the shipping container for damage. If the container or cushioning material is damaged, retain until the contents of the shipment have been checked against the packing list and the instrument has been checked for mechanical and electrical operation.

If the 37XXXD is damaged mechanically, notify your local sales representative or Anritsu Customer Service. If either the shipping container is damaged or the cushioning material shows signs of stress, notify the carrier as well as Anritsu. Keep the shipping materials for the carrier's inspection.



#### WARNING

Use two or more people to lift and move this equipment, or use an equipment cart. There is a risk of back injury, if this equipment is lifted by one person.

### 2-3 PREPARATION FOR USE

Except for units with Option 4 (see following page), no initial setup is required. After unpacking, the 37XXXD is ready for use. The 37XXXD is equipped with automatic line-power sensing, and will operate with any of the following line voltages: 100V, 120V, 220V, 240V +5%, -10%, 48-63 Hz, 350 VA. The 37XXXD is intended for Installation Category (Overvoltage Category) II.



#### WARNING

When supplying power to this equipment, always use a three-wire power cable connected to a three-wire power line outlet. If power is supplied without grounding the equipment, there is a risk of receiving a severe or fatal electric shock.

**Option 4,  
External SCSI Drive Setup**

The 37XXXD is available with an external SCSI drive interface as Option 4. This option deletes the usual internal hard disk and provides support for the use of an external SCSI drive.

An external SCSI drive and interface cable are not included with Option 4, but may be purchased from Anritsu. Contact your local sales representative for information on availability and price. Compatible drives may also be purchased from your local computer retailer.

**Requirements:**

- Interface: SCSI, SCSI-2
- Supported Drives: Iomega® Zip® 100MB SCSI, Zip® 250MB SCSI, Jaz 1, Jaz 2 (other drives may operate, but are not guaranteed)
- Connector: Centronics 50 Male Pro Series SCSI I (37XXXD is Female)
- SCSI ID: 5
- Terminated: Yes

**System Boot:**

Depending on your system configuration at the time of shipment, a drive (and cartridge) may be included. If not, your external drive must be connected to the 37XXXD and initialized with the system files as described below *before* proceeding.

Ensure that the drive is configured correctly and powered on. If the drive is a cartridge type, ensure that a cartridge with the system file on it is installed. Turn on the 37XXXD and the system should boot normally. Cartridges may then be exchanged if you wish to share files.

**Initializing the Drive:**

A set of 37000 Basic Measurement Software floppy disks, Anritsu part number 2300-212, is required. This 4-disk set is supplied with your shipment. Anritsu recommends BMS version 4.01 or above when using an external SCSI drive.

**NOTE**

This operation will erase all of the files on the SCSI drive. Copy any important files before proceeding.

- Step 1. Connect the external drive to the 37XXXD's rear panel SCSI port with the interface cable (refer to Appendix B for information on the rear panel connectors). Ensure that the external SCSI drive is powered on with a cartridge installed (if applicable).
- Step 2. With the 37XXXD powered off, insert Disk 1 of the 37000 BMS into the 37XXXD floppy drive.
- Step 3. Power up the 37XXXD and immediately press any key to view the "Format Hard Drive" menu.
- Step 4. Press 1 to format the drive. Disk 1 will load automatically.
- Step 5. Follow the instructions on the 37XXXD display to load the next three disks. During this step, the system files are transferred to the SCSI drive.

The SCSI drive initialization is now complete. The 37XXXD should sweep with no displayed errors and is now ready to boot-up from the external drive at power-on.

### **2-4 GPIB SETUP**

All functions of the 37XXXD (except power on/off and initialization of the hard disk) can be controlled remotely by an external computer/controller via the IEEE-488.2 GPIB. The information in this section pertains to interface connections and cable requirements for the rear panel GPIB connector. Refer to the Model 37XXXD Programming Manual, Anritsu Part Number 10410-00262, for information about remote operation of the 37XXXD using the GPIB.

The 37XXXD GPIB operates with any IBM XT, AT, or PS/2 compatible computer/controller equipped with a National Instruments GPIB-PCII/IIA interface card and software.

#### ***Interface Connector***

Interface between the 37XXXD and other devices on the GPIB is via a standard 24-wire GPIB interface cable. For proper operation, order Anritsu part number 2100-1, -2, -4, or -5 (1, 2, 4, or 0.5 meter length) cables through your local sales representative. This cable uses a double-sided connector; one connector face is a plug, the other a receptacle. These double-function connectors allow parallel connection of two or more cables to a single instrument connector. The pin assignments for the rear panel GPIB connector are shown in Figure B-2, located in Appendix B.

#### ***Cable Length Restrictions***

The GPIB system can accommodate up to 15 instruments at any one time. To achieve design performance on the bus, proper timing and voltage level relationships must be maintained. If either the cable length between separate instruments or the accumulated cable length between all instruments is too long, the data and control lines cannot be driven properly and the system may fail to perform. Cable length restrictions are as follows:

- No more than 15 instruments may be installed on the bus.
- Total accumulative cable length in meters may not exceed two times the number of bus instruments or 20 meters—whichever is less.

#### ***NOTE***

For low EMI applications, the GPIB cable should be a fully shielded type, with well-grounded metal-shell connectors. (Use Anritsu 2100-series cables.)



## 2-5 SYSTEM GPIB INTERCONNECTION

There are two rear panel GPIB IEEE-488 connectors. The IEEE 488.2 connector used to interface the 37XXXD to an external computer/ controller via a standard GPIB cable. The Dedicated GPIB connector is used to interface to plotters and a second source for multiple source operation via a standard GPIB cable.

### *GPIB Interface to an External Plotter*

The 37XXXD GPIB interface can be configured to control a suitable external plotter (refer to Chapter 6, Data Displays). In this mode of operation, the GPIB is dedicated to this application and only the 37XXXD and the plotter are connected to the GPIB. Standard GPIB cables are used to interconnect to the plotter.

### *GPIB Addresses*

The 37XXXD leaves the factory with the default GPIB address set to six. This address may be changed using the GP7 menu (see Appendix A).

## 2-6 ETHERNET SETUP AND INTERCONNECTION

The 37XXXD can be remotely controlled via a network server and an Ethernet connection via the standard RJ45 connector on the rear panel. The 37XXXD software supports the TCP/IP network protocol. The TCP/IP protocol setup requires the following:

- ❑ **IP Address:** Every computer/electronic device in a TCP/IP network requires an IP address. An IP address has four numbers (each between 0 and 255) separated by periods. For example: 128.111.122.42 is a valid IP address
- ❑ **Subnet Mask:** The subnet mask distinguishes the portion of the IP address that is the network ID from the portion that is the station ID. The subnet mask 255.255.0.0, when applied to the IP address given above, would identify the network ID as 128.111 and the station ID as 122.42. All stations in the same Local Area Network (LAN) should have the same network ID but different station IDs
- ❑ **Default Gateway:** A TCP/IP network can have a gateway to communicate beyond the LAN identified by the network ID. A gateway is a computer or electronic device that is connected to two different networks and can move TCP/IP data from one network to the other. A single LAN that is not connected to other LANs requires a default gateway setting of 0.0.0.0. This (0.0.0.0) is Lightning's default gateway setting. If you have a gateway, then the default gateway would be set to the appropriate value of your gateway.

### **NOTE**

The default gateway setting is only activated after the system power is recycled.

- ❑ **Ethernet Address:** An Ethernet address is a unique 48-bit value that identifies a network interface card to the rest of the network. Every network card has a unique ethernet address permanently stored into its memory. Inappropriate setting of the Default Gateway IP Address will cause the Lightning system to appear to be locked up at start up. The instrument will appear to stop working at the following message:

Application loaded successfully, starting system...

## **2-7** **EXTERNAL MONITOR CONNECTOR**

The rear panel External Monitor connector allows the internal display information of the 37XXXD to be connected to an external VGA monitor (either color or monochrome). The pinout of this 15-pin Type D connector is shown in Figure B-5, located in Appendix B.

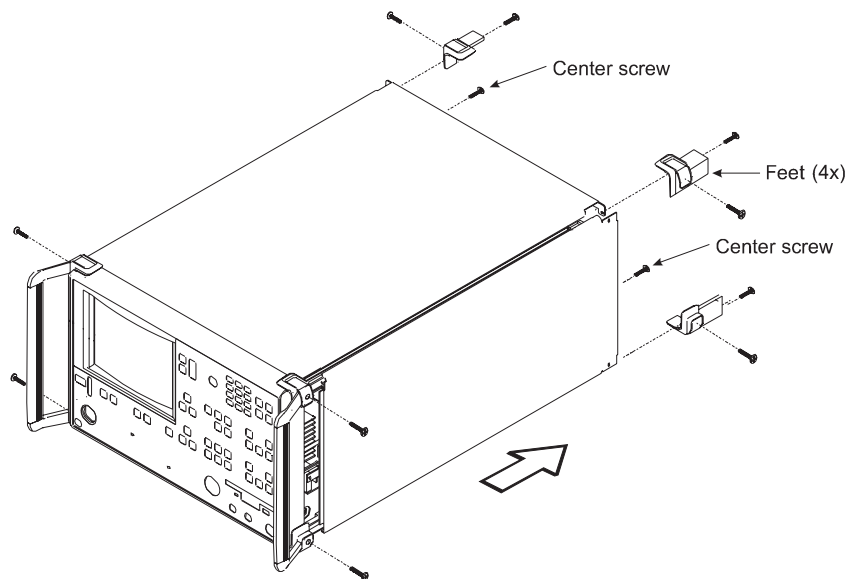
## **2-8** **RACK MOUNT**

To install the Option 1 Rack Mount rails, refer to the below-listed procedure.

- Step 1. Disconnect the line cord and any other attachments from the instrument.
- Step 2. Carefully place the instrument on its top (bottom-side up) on a secure and stable work surface.

## INSTALLATION RACK MOUNT

- Step 3. Using a Phillips screwdriver, remove the two handles or four bumper assemblies (and tilt bail, if installed) from the front of the unit, and the four feet at the rear (Figure 2-1). Save the screws for later use.



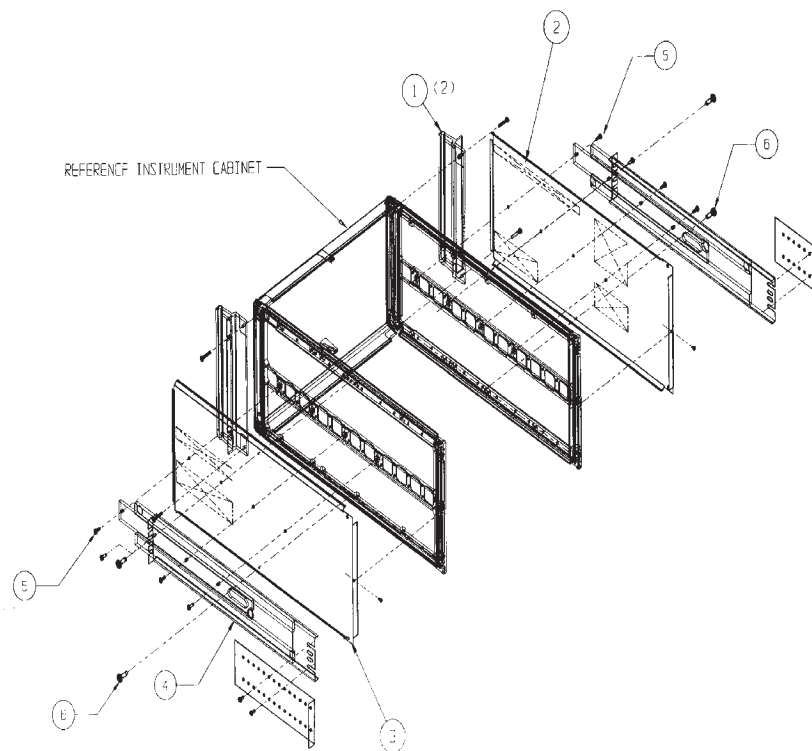
**Figure 2-1.** Removing Cover

### NOTES

- ❑ The green-headed screws are metric threads and must be used only in the appropriately tapped holes
  - ❑ The feet, handles, and bumpers are not reused in this application
- Step 4. Remove the center screws from the rear of the left and right side covers.
- Step 5. Remove the two side carrying handle screws (if so equipped) located under the plastic handle ends.
- Step 6. Remove the left and right side covers. These side covers are not reused in this application.
- Step 7. Install the two Rack Mount Handles using the green-headed screws removed earlier.

Refer to Figure 2-2, on the following page, for the remainder of the assembly procedure.

- Step 8. Secure the new left cover (2) from this retrofit kit to the left side chassis of the instrument by installing the two center screws (6) to the top and bottom and the previously removed center screw at the rear of the left cover.
- Step 9. Secure the slide assembly (4) to the left cover by installing the four mounting screws (5) to the left chassis.



**Figure 2-2.** Mounting Rails

- Step 10. Secure the new right cover (3) from this retrofit kit to the right side chassis of the instrument by installing the center screw (6) through the center of the right side cover and the previously removed center screw at the rear of the right side cover.
- Step 11. Secure the slide assembly (4) to the right cover by installing the four mounting screws (5) to the right chassis.

This completes the installation of the slide assembly.

**2-9 STORAGE OR SHIPMENT**

The following paragraphs describe the procedure for preparing the 37XXXD for storage or shipment.

***Preparation for Storage***

Preparing the 37XXXD for storage consists of cleaning the unit, packing the inside with moisture-absorbing desiccant crystals, and storing the unit in a temperature environment that is maintained between -40 and +70 degrees centigrade (-40 to 156 degrees Fahrenheit).

***Preparation for Shipment***

To provide maximum protection against damage in transit, the 37XXXD should be repackaged in the original shipping container. If this container is no longer available and the 37XXXD is being returned to Anritsu for repair, advise Anritsu Customer Service; they will send a new shipping container free of charge. In the event neither of these two options is possible, instructions for packaging and shipment are given below.

***Use a Suitable Container***

Obtain a corrugated cardboard carton with a 275-pound test strength. This carton should have inside dimensions of no less than six inches larger than the instrument dimensions to allow for cushioning.

***Protect the Instrument***

Surround the instrument with polyethylene sheeting to protect the finish.

***Cushion the Instrument***

Cushion the instrument on all sides by tightly packing dunnage or urethane foam between the carton and the instrument. Provide at least three inches of dunnage on all sides.

***Seal the Container***

Seal the carton by using either shipping tape or an industrial stapler.

***Address the Container***

If the instrument is being returned to Anritsu for service, mark the Anritsu address and your return address on the carton in one or more prominent locations. Refer to the address of your local representative listed in Table 2-1 on the following page.

**2-10 SERVICE CENTERS**

Table 2-1 provides a list of international service centers.

**Table 2-1.** Anritsu Service Centers**UNITED STATES**

ANRITSU COMPANY  
490 Jarvis Drive  
Morgan Hill, CA 95037-2809  
Telephone: (408) 776-8300  
1-800-ANRITSU  
FAX: 408-776-1744

ANRITSU COMPANY  
10 New Maple Ave., Unit 305  
Pine Brook, NJ 07058  
Telephone: (973) 227-8999  
1-800-ANRITSU  
FAX: 973-575-0092

ANRITSU COMPANY  
1155 E. Collins Blvd  
Richardson, TX 75081  
Telephone: 1-800-ANRITSU  
FAX: 972-671-1877

**AUSTRALIA**

ANRITSU PTY. LTD.  
Unit 3, 170 Foster Road  
Mt Waverley, VIC 3149  
Australia  
Telephone: 03-9558-8177  
FAX: 03-9558-8255

**BRAZIL**

ANRITSU ELECTRONICA LTDA.  
Praia de Botafogo, 440, Sala 2401  
CEP22250-040, Rio de Janeiro, RJ, Brazil  
Telephone: 021-527-6922  
FAX: 021-53-71-456

**CANADA**

ANRITSU INSTRUMENTS LTD.  
700 Silver Seven Road, Suite 120  
Kanata, Ontario K2V 1C3  
Telephone: (613) 591-2003  
FAX: (613) 591-1006

**CHINA**

ANRITSU ELECTRONICS (SHANGHAI) CO. LTD.  
2F, Rm B, 52 Section Factory Building  
No. 516 Fu Te Rd (N)  
Shanghai 200131 P.R. China  
Telephone: 21-58680226, 58680227, 58680228  
FAX: 21-58680588

**FRANCE**

ANRITSU S.A  
9 Avenue du Quebec  
Zone de Courtaboeuf  
91951 Les Ulis Cedex  
Telephone: 016-09-21-550  
FAX: 016-44-61-065

**GERMANY**

ANRITSU GmbH  
Grafenberger Allee 54-56  
D-40237 Dusseldorf, Germany  
Telephone: 0211-968550  
FAX: 0211-968555

**INDIA**

MEERA AGENCIES PVT. LTD.  
23 Community Centre  
Zamroodpur, Kailash Colony Extension,  
New Delhi, India 110 048  
Phone: 011-2-6442700/6442800  
FAX : 011-2-644250023

**ISRAEL**

TECH-CENT, LTD.  
4 Raul Valenberg St  
Tel-Aviv 69719  
Telephone: (03) 64-78-563  
FAX: (03) 64-78-334

**ITALY**

ANRITSU Sp.A  
Roma Office  
Via E. Vittorini, 129  
00144 Roma EUR  
Telephone: (06) 50-99-711  
FAX: (06) 50-22-425

**KOREA**

ANRITSU CORPORATION LTD.  
Head Office:  
8F, Hyunjuk Building, 832-41  
Yeoksam-Dong, Kangnam-Ku  
Seoul 135-080, South Korea  
Telephone: 02-553-6603  
FAX: 02-553-6605

**JAPAN**

ANRITSU CUSTOMER SERVICES LTD.  
1800 Onna Atsugi-shi  
Kanagawa-Prf. 243 Japan  
Telephone: 0462-96-6688  
FAX: 0462-25-8379

**SINGAPORE**

ANRITSU (SINGAPORE) PTE LTD.  
10, Hoe Chiang Road  
#07-01/02 Keppel Towers  
Singapore 089315  
Telephone: 6-282-2400  
FAX: 6-282-2533

**SOUTH AFRICA**

ETEC SA  
12 Surrey Square Office Park  
330 Surrey Avenue  
Ferndale, Randburt, 2194  
South Africa  
Telephone: 011-27-11-787-7200  
FAX: 011-27-11-787-0446

**SWEDEN**

ANRITSU AB  
Borgafjordsgatan 13  
164 40 KISTA, Sweden  
Telephone: +46-8-53470700  
FAX: +46-8-53470730

**TAIWAN**

ANRITSU CO., INC.  
7F, No. 316, Section 1  
NeiHu Road  
Taipei, Taiwan, R.O.C.  
Telephone: 886-2-8751-1816  
FAX: 886-2-8751-2126

**UNITED KINGDOM**

ANRITSU LTD.  
200 Capability Green  
Luton, Bedfordshire  
LU1 3LU, England  
Telephone: 015-82-433200  
FAX: 015-82-731303

# **Chapter 3**

## **Network Analyzers, A Primer**

### **Table of Contents**

---

3-1	INTRODUCTION . . . . .	3-3
3-2	GENERAL DESCRIPTION . . . . .	3-3
	Source Module. . . . .	3-4
	Test Set Module . . . . .	3-4
	Analyzer Module . . . . .	3-4
3-3	NETWORK ANALYZERS . . . . .	3-5





# Chapter 3

## Network Analyzers, A Primer

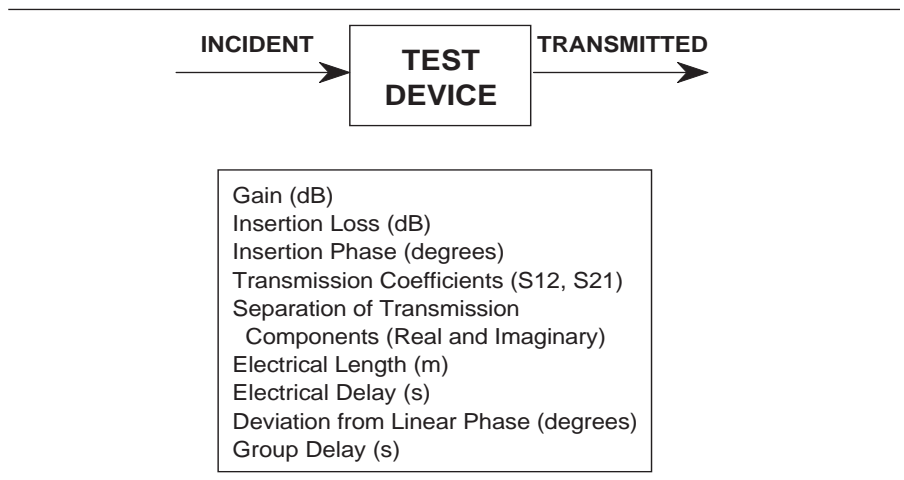
### 3-1 INTRODUCTION

This section provides front panel operating and measurement application information and data. It includes discussions on the following topics:

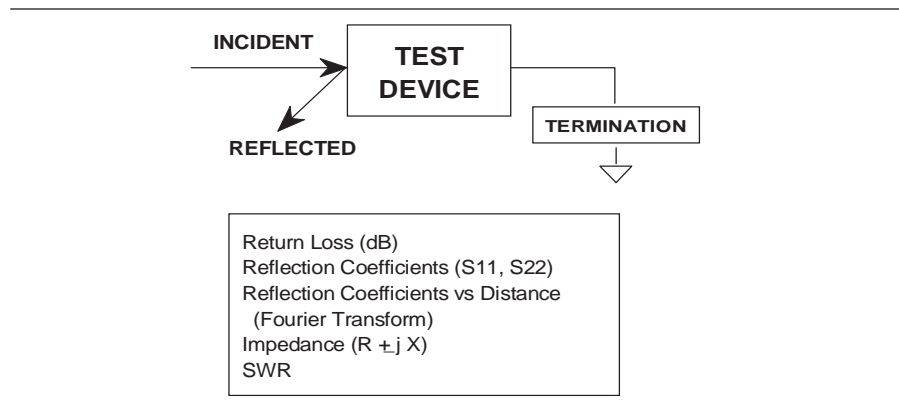
- System description
- General discussion about network analyzers
- Basic measurements and how to make them
- Error correction
- General discussion on test sets

### 3-2 GENERAL DESCRIPTION

The Model 37XXXD Vector Network Analyzer System measures the magnitude and phase characteristics of networks, amplifiers, attenuators, and antennas. It compares the incident signal that leaves the analyzer with either the signal that is transmitted through the test device or the signal that is reflected from its input. Figure 3-1 and Figure 3-2 illustrate the types of measurements that the 37XXXD can make.



**Figure 3-1.** Transmission Measurements



**Figure 3-2.** Reflection Measurements

The 37XXXD is a self-contained, fully integrated measurement system that includes an optional time domain capability. The system hardware consists of the following:

- Analyzer
- Precision components required for calibration and performance verification
- Optional use of Anritsu 67XXB, 68XXXA/B/C, or 69XXXA/B as a second source

The 37XXXD internal system modules perform the following functions:

#### **Source Module**

This module provides the stimulus to the device under test (DUT). The frequency range of the source and test set modules establish the frequency range of the system. The frequency stability of the source is an important factor in the accuracy (especially phase accuracy) of the network analyzer. Hence, the 37XXXD always phase locks the source to an internal 10 MHz crystal reference.

#### **Test Set Module**

The test set module routes the stimulus signal to the DUT and samples the reflected and transmitted signals. The type of connector used is important, as is the “Auto Reversing” feature. Auto Reversing means that it applies the stimulus signal in both the forward and reverse direction. The direction is reversed automatically. This saves you from having to reverse the test device physically to measure all four scattering parameters (S-parameters). Frequency conversion (1st and 2nd IFs) occurs in the test set module.

#### **Analyzer Module**

The analyzer module down-converts, receives, and interprets the 3rd IF signal for phase and magnitude data. It then displays the results of this analysis on a large, 190 mm (7-1/2 inch) diagonal color display. This display can show all four S-parameters simultaneously. In addition to the installed display, you can also view the measurement results on an external color monitor.

### 3-3 NETWORK ANALYZERS

We will begin this discussion with a subject familiar to most Anritsu customers: scalar network analysis. After showing comparisons, we will proceed to the fundamentals of network analyzer terminology and techniques. This discussion serves as an introduction to topics presented in greater detail later in this section. This discussion will touch on new concepts that include the following:

- ❑ Reference Delay
- ❑ S-parameters: what they are and how they are displayed
- ❑ Complex Impedance and Smith Charts

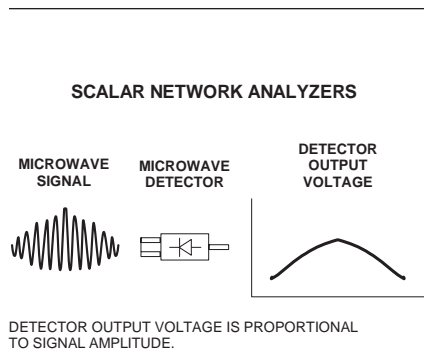
#### Scalar Analyzer Comparison

Network Analyzers do everything that scalar analyzers do except display absolute power. In addition, they add the ability to measure the phase characteristics of microwave devices and allow greater dynamic range.

If all a Network Analyzer added was the capability for measuring phase characteristics, its usefulness would be limited. While phase measurements are important in themselves, it is the availability of this phase information that unlocks many new features for complex measurements. These features include Smith Charts, Time Domain, and Group Delay. Phase information also allows greater accuracy through *vector error correction* of the measured signal.

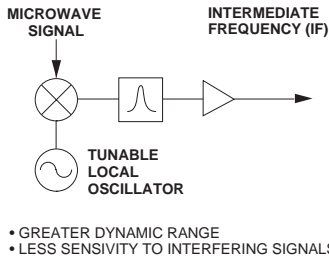
First, let us look at scalar network analyzers (SNAs). SNAs measure microwave signals by converting them to a DC voltage using a diode detector (Figure 3-3). This DC voltage is proportional to the magnitude of the incoming signal. The detection process, however, ignores any information regarding the phase of the microwave signal.

In a network analyzer, access is needed to both the magnitude and phase of a microwave signal. There are several different ways to perform the measurement. The method Anritsu employs (called Harmonic Sampling or Harmonic Mixing) is to down-convert the signal to a lower intermediate frequency (IF). This signal can then be measured directly by a tuned receiver. The tuned receiver approach gives the system greater dynamic range. The system is also much less sensitive to interfering signals, including harmonics.



**Figure 3-3.** *Scalar Analyzer Detection*

A NETWORK ANALYZER IS A TUNED RECEIVER



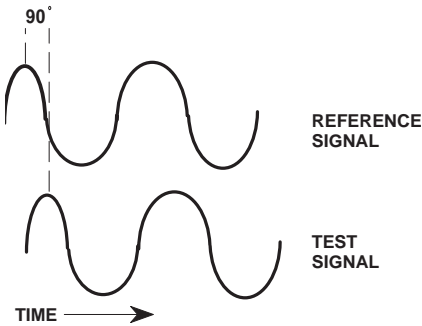
**Figure 3-4.** Network Analyzer is a Tuned Receiver

**Vector Network Analyzer Basics**

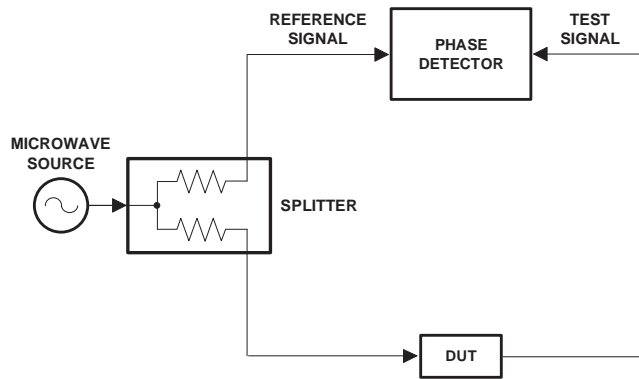
The network analyzer is a tuned receiver (Figure 3-4, left). The microwave signal is down converted into the passband of the IF. To measure the phase of this signal, we must have a reference to compare it with. If the phase of a signal is 90 degrees, it is 90 degrees different from the reference signal (Figure 3-5, left). The network analyzer would read this as  $-90$  degrees, since the test signal is delayed by 90 degrees with respect to the reference signal.

This phase reference can be obtained by splitting off some of the microwave signal before the measurement (Figure 3-7, below).

PHASE MEASUREMENT



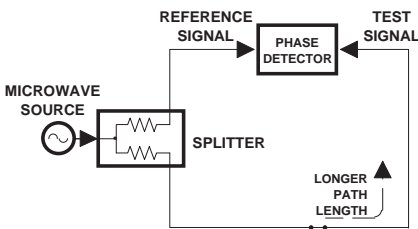
**Figure 3-5.** Signals with a 90 Degree Phase Difference



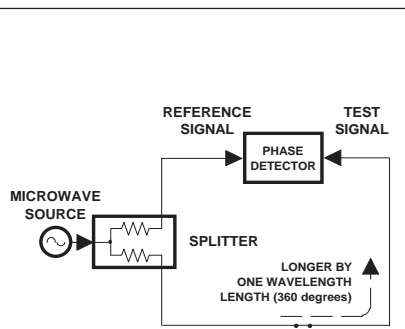
**Figure 3-7.** Splitting the Microwave Signal

The phase of the microwave signal after it has passed through the device under test (DUT) is then compared with the reference signal. A network analyzer test set automatically samples the reference signal, so no external hardware is needed.

Let us consider for a moment that you remove the DUT and substitute a length of transmission line (Figure 3-6, left). Note that the path length of the test signal is longer than that of the reference signal. Now let us see how this affects our measurement.



**Figure 3-6.** Split Signal where a Length of Line Replaces the DUT



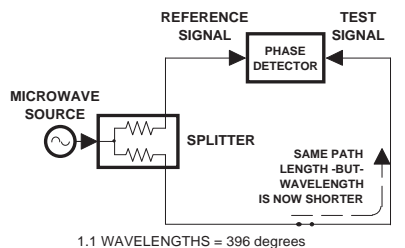
**Figure 3-8.** Split Signal where Path Length Differs by Exactly One Wavelength

Assume that we are making a measurement at 1 GHz and that the difference in path-length between the two signals is exactly 1 wavelength. This means that test signal is lagging the reference signal by 360 degrees (Figure 3-8). We cannot really tell the difference between one sine wave maxima and the next (they are all identical), so the network analyzer would measure a phase difference of 0 degrees.

Now consider that we make this same measurement at 1.1 GHz. The frequency is higher by 10 percent so therefore the wavelength is shorter by 10 percent. The test signal path length is now 0.1 wavelength longer than that of the reference signal (Figure 3-9). This test signal is:

$$1.1 \times 360 = 396 \text{ degrees}$$

This is 36 degrees different from the phase measurement at 1 GHz. The network analyzer will display this phase difference as -36 degrees.

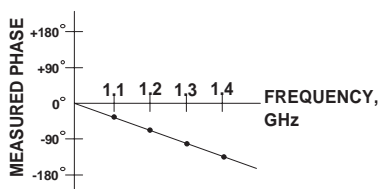


**Figure 3-9.** Split Signal where Path Length is Longer than One

The test signal at 1.1 GHz is delayed by 36 degrees more than the test signal at 1 GHz.

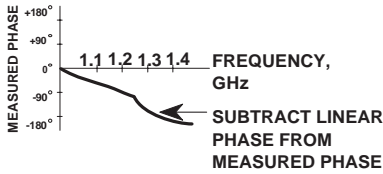
You can see that if the measurement frequency is 1.2 GHz, we will get a reading of -72 degrees, -108 degrees for 1.3 GHz, etc. (Figure 3-10). There is an electrical delay between the reference and test signals. For this delay we will use the common industry term of reference delay. You also may hear it called phase delay. In older network analyzers you had to equalize the length of the reference arm with that of the test arm to make an appropriate measurement of phase vs. frequency.

To measure phase on a DUT, we want to remove this phase-change-vs.-frequency due to changes in the electrical length. This will allow us to view the actual phase characteristics. These characteristics may be much smaller than the phase change due to electrical length difference.

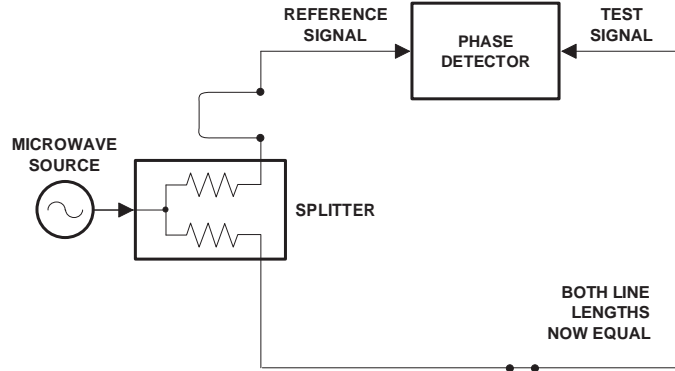


**Figure 3-10.** Electrical Delay

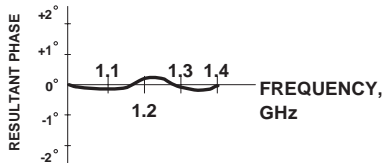
There are two ways of accomplishing this. The most obvious way is to insert a length of line into the reference signal path to make both paths of equal length (Figure 3-11, below). With perfect transmission lines and a perfect splitter, we would then measure a constant phase as we change the frequency. The problem using this approach is that we must change the line length with each measurement setup.



**Figure 3-12.** Phase Difference Increases Linearly with Frequency



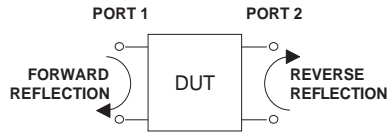
**Figure 3-11.** Split Signal where Paths are of Equal Length



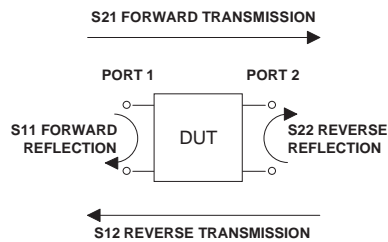
**Figure 3-13.** Resultant Phase with Path Length

Another approach is to handle the path length difference in software. Figure 3-12 (left) displays the phase-vs.-frequency of a device. This device has different effects on the output phase at different frequencies. Because of these differences, we do not have a perfectly linear phase response. We can easily detect this phase deviation by compensating for the linear phase. The size of the phase difference increases linearly with frequency so we can modify the phase display to eliminate this delay.

The 37XXXD offers automatic reference delay compensation with the push of a button. Figure 3-13 (left) shows the resultant measurement when we compensate path length. In a system application you can usually correct for length differences; however, the residual phase characteristics are critical.



**Figure 3-14.** Forward and Reverse Measurements



**Figure 3-15.** S-parameters



**Figure 3-16.** Linear Phase-with-frequency Waveform

**Network Analyzer Measurements**

Now let us consider measuring the DUT. Consider a two port device; that is, a device with a connector on each end. What measurements would be of interest?

First, we could measure the reflection characteristics at either end with the other end terminated into 50 ohms. If we designate one end as the normal place for the input that gives a reference. We can then define the reflection characteristics from the reference end as forward reflection, and those from the other end as reverse reflection (Figure 3-14).

Second, we can measure the forward and reverse transmission characteristics. However, instead of saying “forward,” “reverse,” “reflection,” and “transmission” all the time, we use a shorthand. That is all that S-parameters are, a shorthand! The “S” stands for scattering. The second number is the device port that the signal is being injected into, while the first is the device port that the signal is leaving. S<sub>11</sub>, therefore, is the signal being injected into port 1 relative to the signal leaving port 1. The four scattering parameters (Figure 3-15) are:

- S<sub>11</sub> Forward Reflection
- S<sub>21</sub> Forward Transmission
- S<sub>22</sub> Reverse Reflection
- S<sub>12</sub> Reverse Transmission

S-parameters can be displayed in many ways. An S-parameter consists of a magnitude and a phase. We can display the magnitude in dB, just like a scalar network analyzer. We often call this term *log magnitude*.

We can display phase as “linear phase” (Figure 3-16). As discussed earlier, we can’t tell the difference between one cycle and the next. Therefore, after going through 360 degrees we are back to where we began. We can display the measurement from -180 to +180 degrees. The -180 to +180 approach is more common. It keeps the display discontinuity removed from the important 0 degree area used as the phase reference.

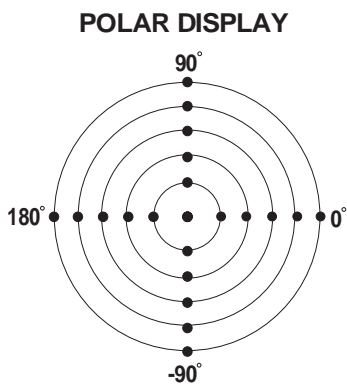


Figure 3-17. Polar Display

There are several ways in which all the information can be displayed on one trace. One method is a polar display (Figure 3-17). The radial parameter (distance from the center) is magnitude. The rotation around the circle is phase. We sometimes use polar displays to view transmission measurements, especially on cascaded devices (devices in series). The transmission result is the addition of the phase and log magnitude (dB) information of each device's polar display.

As we have discussed, the signal reflected from a DUT has both magnitude and phase. This is because the impedance of the device has both a resistive and a reactive term of the form  $r+jx$ . We refer to the  $r$  as the real or resistive term, while we call  $x$  the imaginary or reactive term. The  $j$ , which we sometimes denote as  $i$ , is an imaginary number. It is the square root of  $-1$ . If  $x$  is positive, the impedance is inductive; if  $x$  is negative, the impedance is capacitive.

SMITH CHART

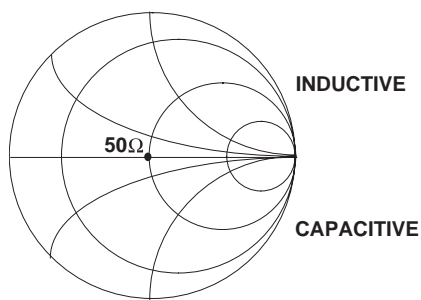


Figure 3-18. Smith Chart

The size and polarity of the reactive component  $x$  is important in impedance matching. The best match to a complex impedance is the complex conjugate. This complex-sounding term simply means an impedance with the same value of  $r$  and  $x$ , but with  $x$  of opposite polarity. This term is best analyzed using a Smith Chart (Figure 3-18), which is a plot of  $r$  and  $x$ .

To display all the information on a single S-parameter requires one or two traces, depending upon the format we want. A very common requirement is to view forward reflection on a Smith Chart (one trace) while observing forward transmission in Log Magnitude and Phase (two traces). Let us see how to accomplish this in the 37XXXD.

The 37XXXD has four channels. Each channel can display a complete S-parameter in any format on either one or two traces. All four S-parameters can be seen simultaneously in any desired format. A total of eight traces can be viewed at the same time. While this is a lot of information to digest, the 37XXXD's large color display makes recognizing and analyzing the data surprisingly easy.



Another important parameter we can measure when phase information is available is group delay. In linear devices, the phase change through the DUT is linear-with-frequency. Thus, doubling the frequency also doubles the phase change. An important measurement, especially for communications system users, is the rate of change-of-phase-vs.-frequency (group delay). If the rate of phase-change-vs.-frequency is not constant, the DUT is nonlinear. This nonlinearity can create distortion in communications systems.

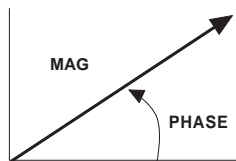
**Measurement Error Correction**

Since we can measure microwave signals in both magnitude and phase, it is possible to correct for six major error terms:

- Source Test Port Match
- Load Test Port Match
- Directivity
- Isolation
- Transmission Frequency Response
- Reflection Frequency Response

We can correct for each of these six error terms in both the forward and reverse directions, hence the name 12-term error correction. Since 12-term error correction requires both forward and reverse measurement information, the test set must be *reversing*. “Reversing” means that it must be able to apply the measurement signal in either the forward or reverse direction.

MAGNITUDE AND PHASE OF EACH ERROR SIGNAL IS MEASURED



THEN THE RESULTANT VECTOR IS APPLIED MATHEMATICALLY, HENCE VECTOR ERROR CORRECTION

To accomplish this error correction, we measure the magnitude and phase of each error signal (Figure 3-19). Magnitude and phase information appear as a vector that is mathematically applied to the measurement signal. This process is termed *vector error correction*.

**Summary**

A vector network analyzer is similar to a scalar network analyzer. The major difference is that it adds the capability for measuring phase as well as amplitude. With phase measurements comes scattering, or S-parameters, which are a shorthand method for identifying forward and reverse transmission and reflection characteristics. The ability to measure phase introduces two new displays, polar and Smith Chart. It also adds vector error correction to the measurement trace. With vector error correction, errors introduced by the measurement system are compensated for and measurement uncertainty is minimized. Phase measurements also add the capability for measuring group delay, which is the rate of change-of-phase vs. frequency (group delay). All in all, using a network analyzer provides for making a more complete analysis of your test device.

**Figure 3-19.** Magnitude and Phase



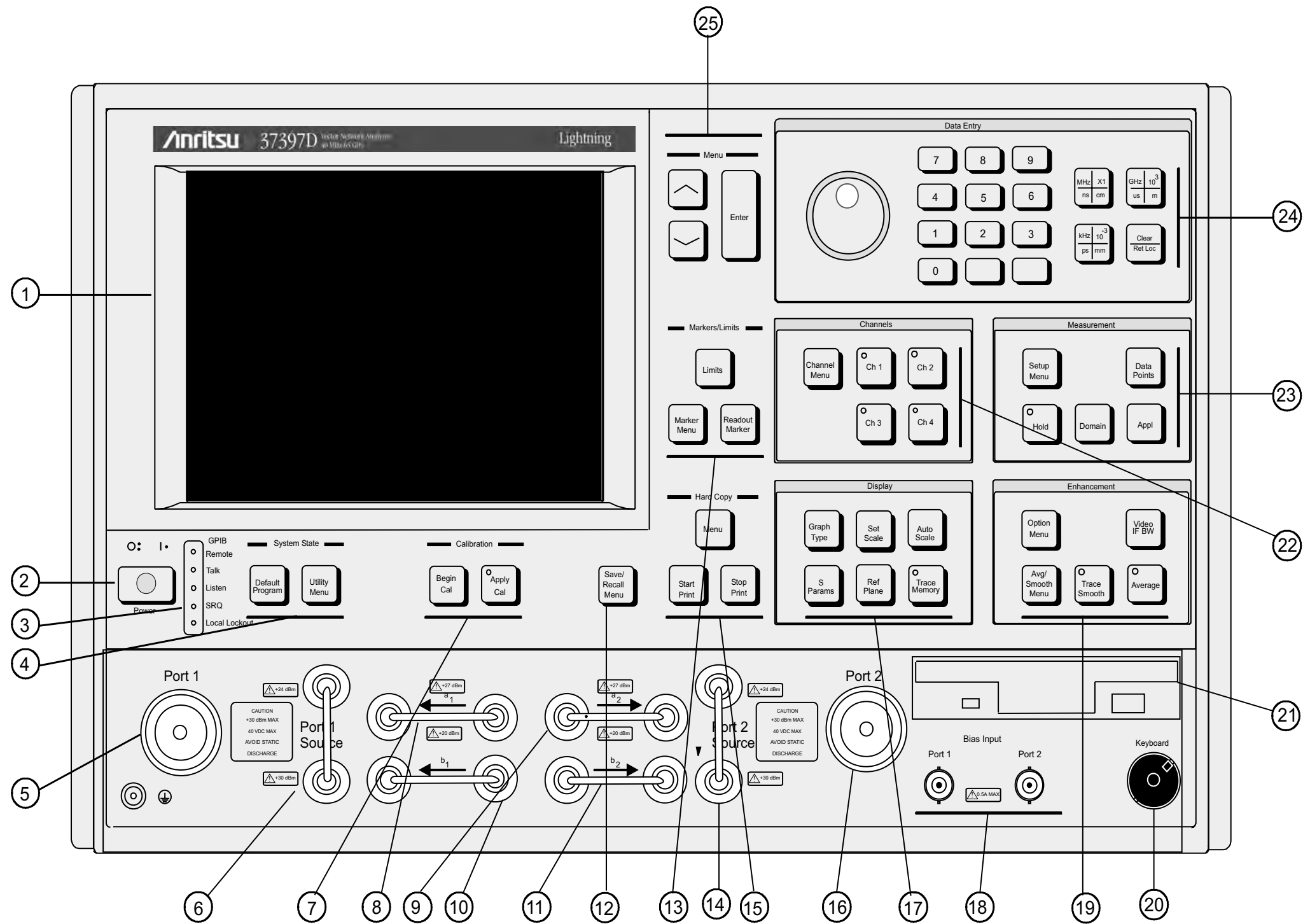
# Chapter 4

## Front Panel Operation

### Table of Contents

---

4-1	INTRODUCTION . . . . .	4-3
4-2	KEY-GROUPS . . . . .	4-3
4-3	CALIBRATION KEY-GROUP . . . . .	4-10
4-4	SAVE/RECALL MENU KEY . . . . .	4-20
4-5	MEASUREMENT KEY-GROUP . . . . .	4-21
4-6	CHANNELS KEY-GROUP . . . . .	4-24
4-7	DISPLAY KEY-GROUP . . . . .	4-25
4-8	ENHANCEMENT KEY-GROUP . . . . .	4-29
4-9	HARD COPY KEY-GROUP . . . . .	4-31
4-10	SYSTEM STATE KEY-GROUP . . . . .	4-33
4-11	MARKERS/LIMITS KEY-GROUP . . . . .	4-36
4-12	DISK STORAGE INTERFACE . . . . .	4-40
	Disk Format . . . . .	4-40
	Disk Files. . . . .	4-40
	Disk File Output Device. . . . .	4-41
	Formatting a Data File Disk . . . . .	4-41
	Copying Data Files From Disk to Disk . . . . .	4-41
	Recovering From Disk Write/Read Errors . . . . .	4-41
4-13	COMMAND LINE . . . . .	4-42
	Create Directory . . . . .	4-42
	List Directory . . . . .	4-42
	Change Directory . . . . .	4-42
	Delete Files. . . . .	4-42
	Remove Directory . . . . .	4-43
	Copy Files . . . . .	4-43
	Conventions . . . . .	4-43



**Figure 4-1.** Model 37XXXD Front Panel

# Chapter 4

## Front Panel Operation

### 4-1 INTRODUCTION

This chapter describes the front panel keys, controls, and menus. The chapter is organized into an overall description of the front panel key-groups and detailed descriptions of individual keys within the key-groups.

### 4-2 KEY-GROUPS

The following pages provide descriptions of the front panel key-groups illustrated in Figure 4-1 on the previous page.

- Index 1.**            **LCD display:** Displays any or all of the four measurement channels, plus menus.
- Index 2.**            **Power:** Turns the 37XXXD on and off. When on, the operating program runs a self test then recalls the parameters and functions in effect when previously powered down.
- Index 3.**            **GPIB Indicators:**
- Remote:** Lights when the 37XXXD switches to remote (GPIB) control. It remains lit until the unit returns to local control.
- Talk:** Lights when you address the 37XXXD to talk and remains lit until unaddressed.
- Listen:** Lights when you address the 37XXXD to listen and remains lit until unaddressed.
- SRQ:** Lights when the 37XXXD sends a Service Requests (SRQ) to the external controller. The LED remains lit until the 37XXXD receives a serial poll or until the controller resets the SRQ function.
- Local Lockout:** Lights when a local lockout message is received. The LED remains lit until the message is rescinded. When lit, you cannot return the 37XXXD to local control via the front panel.

- Index 4.**      **System State Keys:** (Refer to section 4-10, page 4-33, for details and menu flow diagrams.)
- Default Program:** Resets the front panel to the factory-preset state and displays Menu SU1 or SU3 (Appendix A). Pressing this key in conjunction with the “0” or “1” key resets certain internal memories and front panel key states (refer to sections 4-5 and 4-10).
- NOTE**
- Use of the Default Program key will destroy front panel and calibration setup data, unless they have been saved to disk.
- Utility Menu:** Displays the first in a series of menus that let you perform diskette and other utility-type functions and operations.
- Index 5.**      **Port 1 Test Connector:** Provides an input test connection for the device-under-test (DUT).
- Index 6.**      **Port 1 Source Loop:** Provides for inserting additional amplification on Port 1 before the coupler.
- Index 7.**      **Calibration Keys:** (Refer to section 4-3, page 4-10, for details and menu flow diagrams.)
- Begin Cal:** Calls up the first in a sequence of menus that guide you through a measurement calibration. Refer to section 4-3 for a detailed discussion of the calibration keys, indicators, and menus.
- Apply Cal:** Turns on and off the applied error correction and tune mode.
- Index 8.**      **a1 Loop:** Provides direct access to Reference A channel on Port 1 over the entire frequency range. Refer to the front panel for damage levels.
- Index 9.**      **a2 Loop:** Provides direct access to Reference B channel on Port 2 over the entire frequency range. Refer to the front panel for damage levels.
- Index 10.**     **b1 Loop:** Provides direct access to Test A channel on Port 1 over the entire frequency range. Refer to the front panel for damage levels.
- Index 11.**     **b2 Loop:** Provides direct access to Test B channel on Port 2 over the entire frequency range. Refer to the front panel for damage levels.

- Index 12.***      **Save/Recall Menu Key:** Displays the first of several menus that let you save the current calibration or front panel setup or recall a previously saved calibration or setup. Refer to section 4-4, page 4-20, for menu flow diagram.
- Index 13.***      **Markers/Limits Keys:** (Refer to section 4-11, page 4-36, for details and menu flow diagrams.)
- Marker Menu:** Displays the first in a series of menus that let you set and manipulate marker frequencies, times, and distances.
- Readout Marker:** Displays a menu that lists all of the active markers. If no markers are active, the marker menu is displayed.
- Limits:** Displays one of the menus that let you manipulate the limit lines.
- Index 14.***      **Port 2 Source:** Provides for inserting additional amplification on Port 2 before the coupler.
- Index 15.***      **Hard Copy Keys:** (Refer to section 4-9, page 4-31, for details and menu flow diagrams.)
- Menu:** Displays option menus that let you define what will happen each time you press the Start Print key. The displayed menu also selects disk I/O operations.
- Start Print:** Tells the printer or plotter to start output based on the current selections.
- Stop Print:** Immediately stops printing the data, clears the print buffer, and sends a form-feed command to the printer.
- Index 16.***      **Port 2 Test Connector:** Provides an input test connection for the device-under-test (DUT).

**Index 17.**

**Display Keys:** (Refer to section 4-7, page 4-25, for details and menu flow diagrams.)

**Graph Type:** Displays the two menus that let you choose the graph type for the active channel.

**Set Scale:** Displays the appropriate scaling menu, based on the graph type for the active channel.

**Auto Scale:** Automatically scales the active channel for optimum viewing.

**S Params:** Displays Menu SP (Appendix A), which lets you choose between S11, S12, S21, or S22. You may display the same parameter on two or more channels.

**Ref Plane:** Displays the first of two menus that let you set the reference plane for the active channel in time or distance. For a correct distance readout, you must set the dielectric constant to the correct value. Refer to the discussion in menu RD2 (Appendix A).

**Trace Memory:** Displays the menus that let you do any of the following. (1) Store the measured data in memory. (2) View the stored data. (3) Add, subtract, multiply, or divide the measured data from the stored data (normalize to the stored memory). (4) View both the measured and the stored data simultaneously on the active channel. (5) Store/Recall saved data to disk. Four memories exist—one for each channel. This lets you normalize the data in each channel independently. The LED on this button lights when the active channel is displaying memory data or measurement data normalized to memory.

**Index 18.**

**Bias Input Connectors:**

**Port 1:** Provides for supplying a bias voltage for the Port 1 input.

**Port 2:** Provides for supplying a bias voltage for the Port 2 input.



***Index 19.***

**Enhancement Keys:** (Refer to section 4-8, page 4-29 for details and menu flow diagrams.)

**Option Menu:** Displays a series of menus showing the choice of optional features.

**Video IF BW:** Displays a menu that lets you chose between 10 kHz, 1 kHz, 100 Hz, or 10 Hz intermediate frequency (IF) bandwidth filters.

**Avg/Smooth Menu:** Displays a menu that lets you enter values for Averaging and Smoothing.

**Trace Smooth:** Turns the trace smoothing function on and off.

**Average:** Turns the average function on and off.

***Index 20.***

**Keyboard Connector:** Provides for connecting any external keyboard with a standard PS2 connector. All alphanumeric field entries can be input from this keyboard. These inputs include Device ID, Model, Date, Operator Identification, frequencies, filenames, as well as comment-type entries. The analog knob and keypad input for these entries remains active. The F1 through F12 function keys can be used to access certain key and menu functions. A template is provided. Two versions of an actual-size template are provided in a foldout page at the end of this chapter in the event a replacement is needed.

***Index 21.***

**Diskette Drive:** Provides a drive for the 3.5-inch, high-density (1.44 MB) floppy diskette used to store selected front panel setups and calibrations. Refer to section 4-12, page 4-40, for disk storage information.

***Index 22.***

**Channels Keys:** (Refer to section 4-6, page 4-24, for details and menu flow diagrams.)

**Channel Menu:** Displays a menu that lets you select the format for the number of channels displayed.

**Ch 1:** Makes Channel 1 the active channel. The active channel is the one acted on by the keys in the Display section. Only one channel can be active at any one time.

**Ch 2:** Makes Channel 2 the active channel.

**Ch 3:** Makes Channel 3 the active channel.

**Ch 4:** Makes Channel 4 the active channel.

***Index 23.***

**Measurement Keys:** (Refer to section 4-5, page 4-21 for details and menu flow diagrams.)

**Setup Menu:** Displays the first of several menus that let you select functions affecting measurements.

**Data Points:** Displays a menu that lets you select between 1601, 801, 401, 201, 101, or 51 data points.

**Hold:** Toggles the instrument in and out of the hold mode; or it triggers a sweep, depending on the function selected in menu SU4 (Appendix A).

**Domain:** Displays the first in a series of menus that let you set the Time Domain display parameters. (This key is only active if your 37XXXD is equipped with the Time Domain option.)

- If already in the Domain menus, pressing this key will return to the first menu in the sequence.
- If in the Domain menus and another (non-time domain) menu is displayed by pushing a menu key, the last displayed domain menu redisplay when the Domain key is next pressed.

**Applications Menu:** Displays the first in a series of menus that provide instructions for adapter removal and gain compression.

**Index 24.****Data Entry Keys:**

**Rotary Knob:** Used to alter measurement values for the active parameter (Start Frequency, Stop Frequency, Offset, etc.).

**Keypad:** Provides for entering values for the active parameter. The active parameter is the one to which the menu cursor is pointing.

**MHz/X1/ns/cm:** Terminates a value entered on the keypad in the units shown—that is; megahertz for frequency, unity for dimensionless or angle entries, nanoseconds for time, or centimeters for length.

**GHz/10<sup>3</sup>/ms/m:** Terminates a value entered on the keypad in the units shown—that is; gigahertz for frequency, 1×10<sup>3</sup> power for dimensionless or angle entries, microseconds for time, or meters for length.

**kHz/10<sup>-3</sup>/ps/mm:** Terminates a value entered on the keypad in the units shown—that is; kilohertz for frequency, 1×10<sup>-3</sup> for dimensionless or angle entries, picoseconds for time, or millimeters for length.

- *Clear/Ret Loc:* Local (Non-GPIB) Mode: (1) The key clears entries not yet terminated by one of the terminator keys above, which allows the previously displayed values to redisplay. Or (2) the key turns off the displayed menu and expands the data area to fill the entire screen, if you have not made any keypad entries needing termination.
- *GBIB Mode:* The key returns the instrument to local (front panel) control, unless the controller has sent a local lockout message (LLO) over the bus.

**Index 25.****Menu Keys:**

**Arrow Keys:** Moves the menu cursor up and down to select items appearing in the menu area of the LCD.

**Enter:** Implements the menu selection chosen using the arrow keys.

**4-3 CALIBRATION KEY-GROUP**

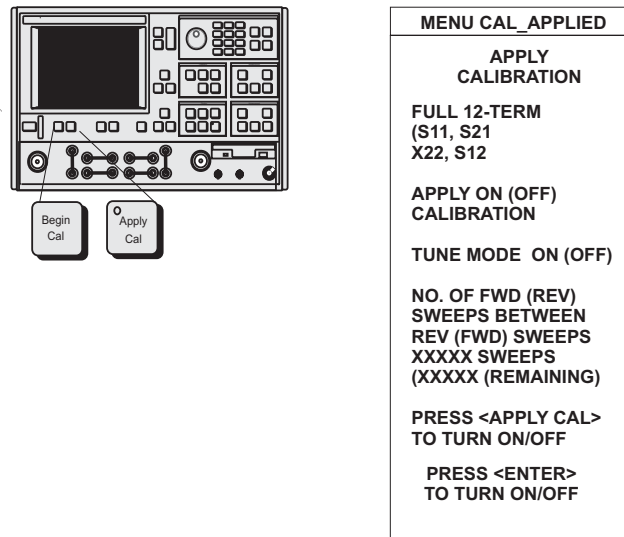
The Calibration keys (Begin Cal and Apply Cal, below) are described below. The calibration menus are diagramed according to the method of calibration performed: Standard, Offset-Short, TRM or LRL/LRM. The menu sequencing is complex and looping and can be said to have two parts: setup and calibration. The setup flow for the four calibration methods is diagramed in Figures 4-3 through 4-6. Each setup flow chart leads to the main calibration sequence, which is diagramed in Figure 4-6. A full description of each menu is provided in Appendix A, where the menus are arranged in alphabetical order by call letter (C1, C2, C3, etc).

**Begin Cal Key:** This key displays a menu that lets you initiate the calibration sequence. That is, to begin a sequence of steps that corrects for errors inherent in a measurement setup.

**Apply Cal Key:** This key displays a menu (below) that lets you turn on and off the error correction that may be applied to the displayed channel(s) using the currently valid error-correction indicator. Additionally, the menu lets you turn the tune mode on and off and change the number of forward sweeps between reverse sweeps (or reverse sweeps between forward sweeps).

**NOTE**

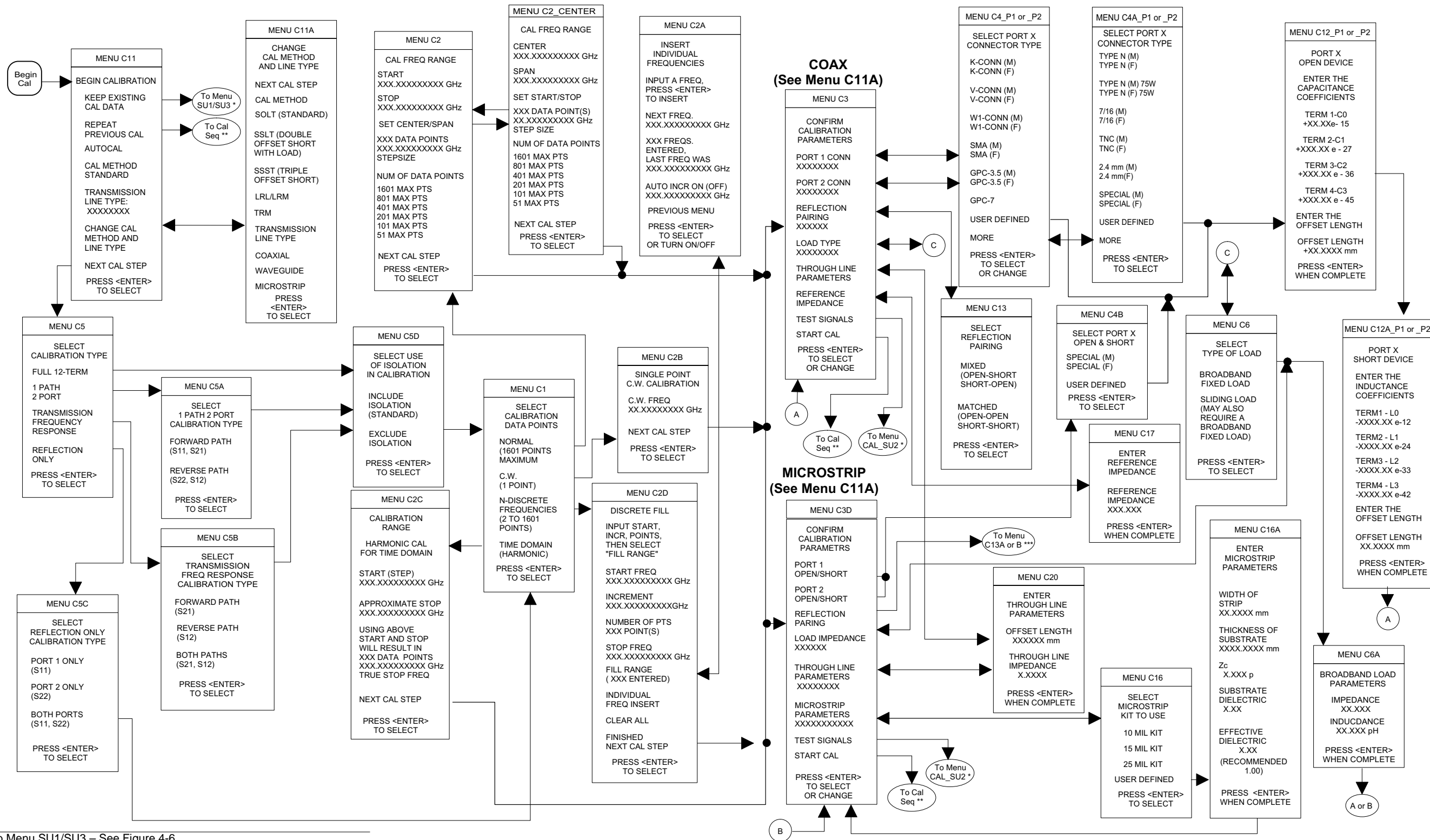
Pressing the Clear key while in a calibration setup or sequencing will let you abort the calibration and return to the first setup menu. Pressing the Setup Menu key will do the same, but without requesting confirmation.



**Figure 4-2.** Calibration Key Group Menu

**Standard Calibration Setup Flow—Description**

1. Pressing the Begin Cal key calls Menu C11.
2. With one exception, the flow is from left to right in the direction of the arrow head. The exception occurs in Menu C1, for the TIME DOMAIN choice. Here the flow direction reverses to Menu C2C then returns to a left-to-right flow on to Menu C3 or C3D.
3. Arrowheads that point both left and right indicate that the flow returns to the right-most menu after a choice had been made.
4. The group of menus to the left of Menu C3 and C3D are the initial selection set and are essentially the same for all four calibration types: Standard, Offset-Short, TRM, and LRL/LRM.
5. The group of menus that follow Menu C3 or C3D are, for the most part, type specific. The selection of Menu C3 or C3D depends upon the choice made in Menu C11A: COAXIAL or MICROSTRIP. For the Standard Calibration, the WAVEGUIDE selection in Menu C11A is not used.



\* Setup Menu SU1/SU3 – See Figure 4-6  
 \*\* Cal Seq (Calibration Sequence) – See Figure 4-5  
 \*\*\* Reflection Pairing Menu C13A or C13B – See Figure 4-4

Figure 4-3. Menu Sequencing, Standard Calibration

**SSLT and SSST (Offset-Short)****Calibration Setup Flow—Description**

1. Pressing the Begin Cal key calls Menu C13.
2. With one exception, the flow is from left to right in the direction of the arrow head. The exception occurs in Menu C1, for the TIME DOMAIN choice. Here the flow direction reverses to Menu C2C then returns to a left-to-right flow on to Menu C3A, C3C, or C3B.
3. Arrowheads that point both left and right indicate that the flow returns to the right-most menu after a choice had been made.
4. The group of menus to the left of Menu C3A, C3C, or C3B are the initial selection set and are essentially the same for all four calibration types: Standard, Offset-Short, TRM, and LRL/LRM.
5. The group of menus that follow Menu C3A, C3C, or C3B are, for the most part, type specific. The selection of Menu C3A, C3C, or C3B depends upon the choice made in Menu C11A: COAXIAL, WAVEGUIDE, or MICROSTRIP.

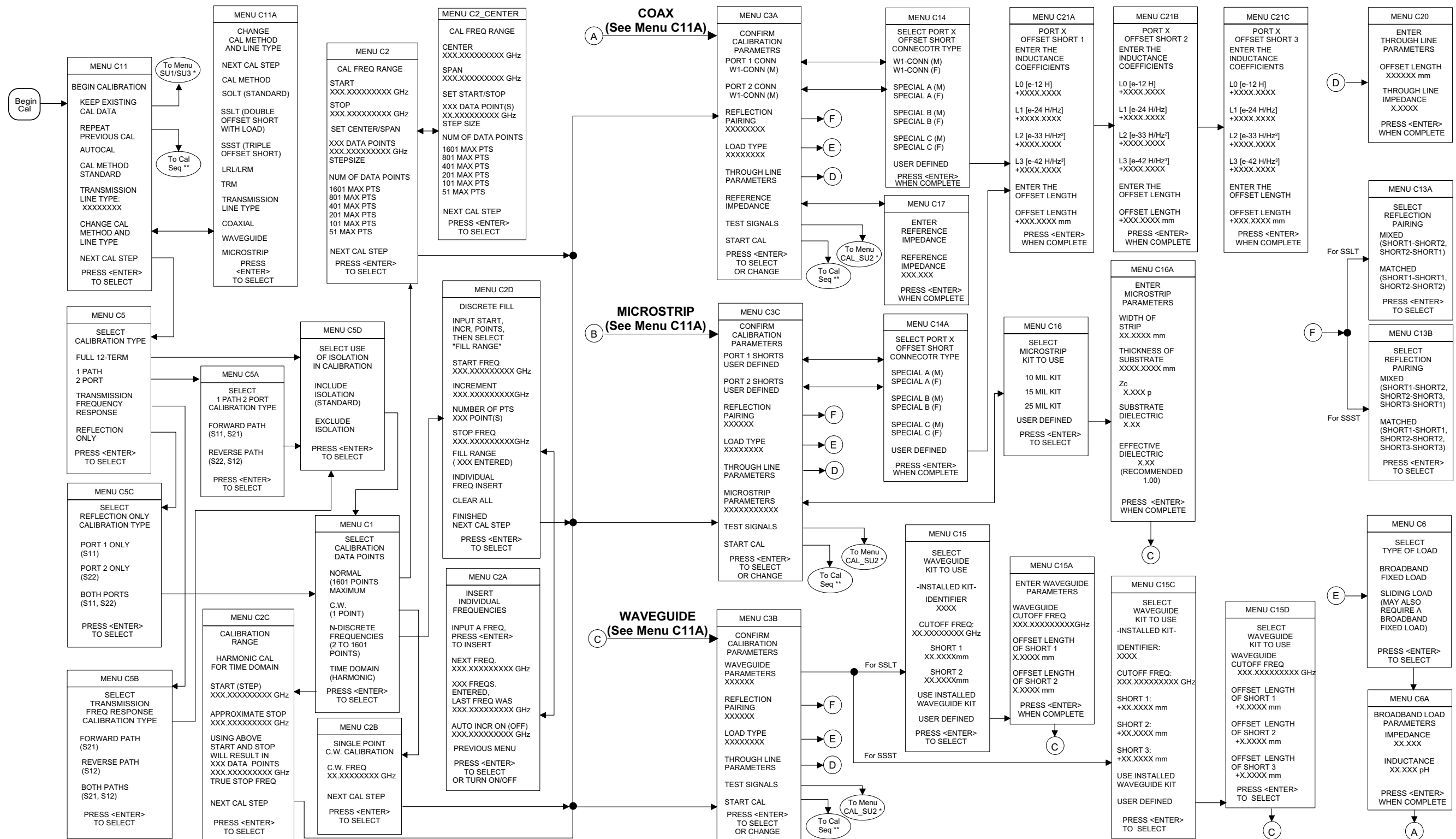


Figure 4-4. Menu Sequencing, SSLT and SSST (Offset-Short) Calibration



**LRL/LRM Calibration Setup Flow—Description**

1. Pressing the Begin Cal key calls Menu C15.
2. With one exception, the flow is from left to right in the direction of the arrow head. The exception occurs in Menu C1, for the TIME DOMAIN choice. Here the flow direction reverses to Menu C2C then returns to a left-to-right flow on to Menu C3E, C3G, or C3F.
3. Arrowheads that point both left and right indicate that the flow returns to the right-most menu after a choice had been made.
4. The group of menus to the left of Menu C3E, C3G, or C3F are the initial selection set and are essentially the same for all four calibration types: Standard, Offset-Short, TRM, and LRL/LRM.
5. The group of menus that follow Menu C3E, C3G, or C3F are, for the most part, type specific. The selection of Menu C3E, C3G, or C3F depends upon the choice made in Menu C11A: COAXIAL, WAVEGUIDE, or MICROSTRIP.



**TRM Calibration Setup Flow—Description**

1. Pressing the Begin Cal key calls Menu C17.
2. With one exception, the flow is from left to right in the direction of the arrow head. The exception occurs in Menu C1, for the TIME DOMAIN choice. Here the flow direction reverses to Menu C2C then returns to a left-to-right flow on to Menu C3H, C3J, or C3I.
3. Arrowheads that point both left and right indicate that the flow returns to the right-most menu after a choice had been made.
4. The group of menus to the left of Menu C3H, C3J, or C3I are the initial selection set and are essentially the same for all four calibration types: Standard, Offset-Short, TRM, and LRL/LRM.
5. The group of menus that follow Menu C3H, C3J, or C3I are, for the most part, type specific. The selection of Menu C3H, C3I, or C3J depends upon the choice made in Menu C11A: COAXIAL, WAVEGUIDE, or MICROSTRIP.

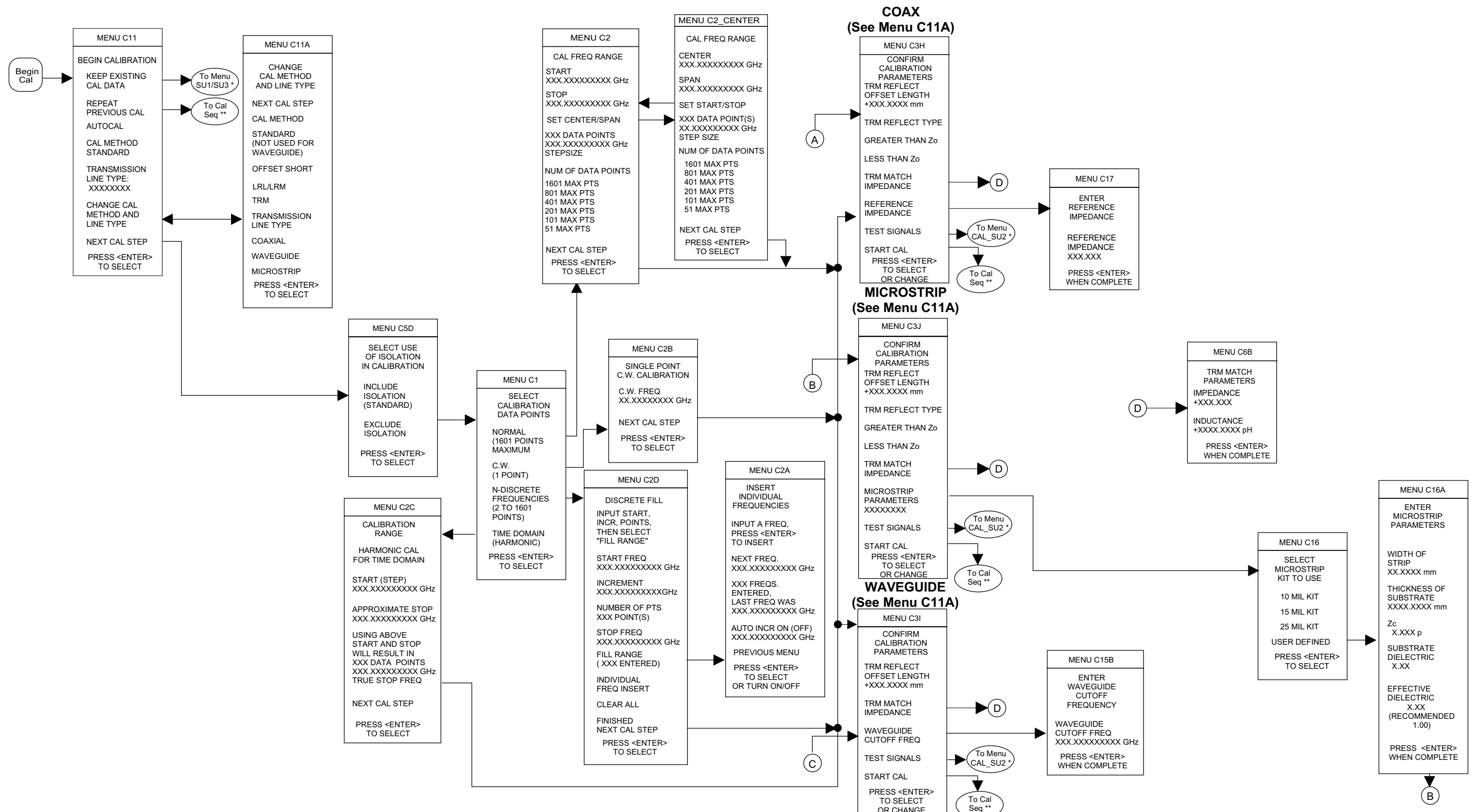


Figure 4-6. Menu Sequencing, TRM Calibration

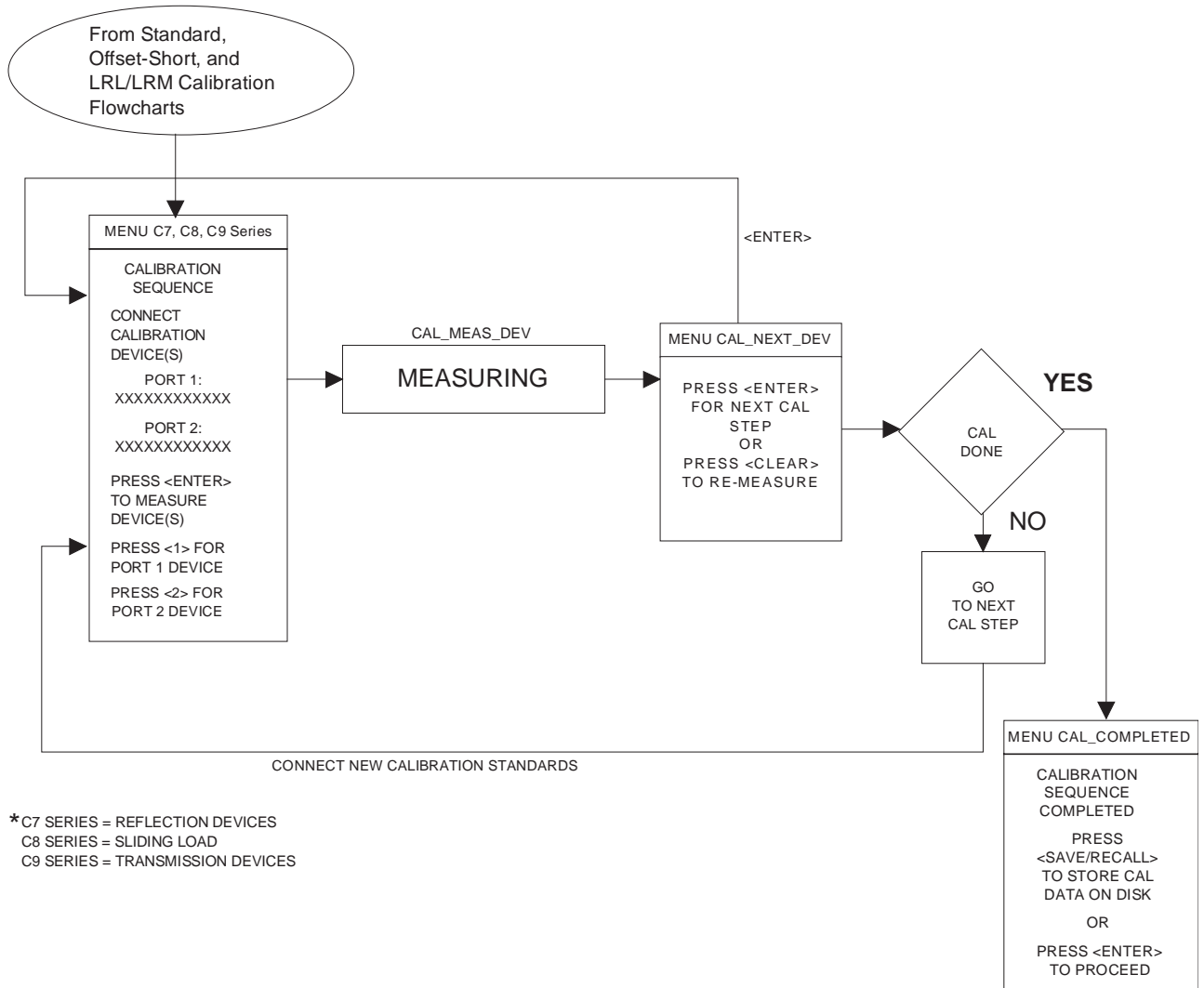
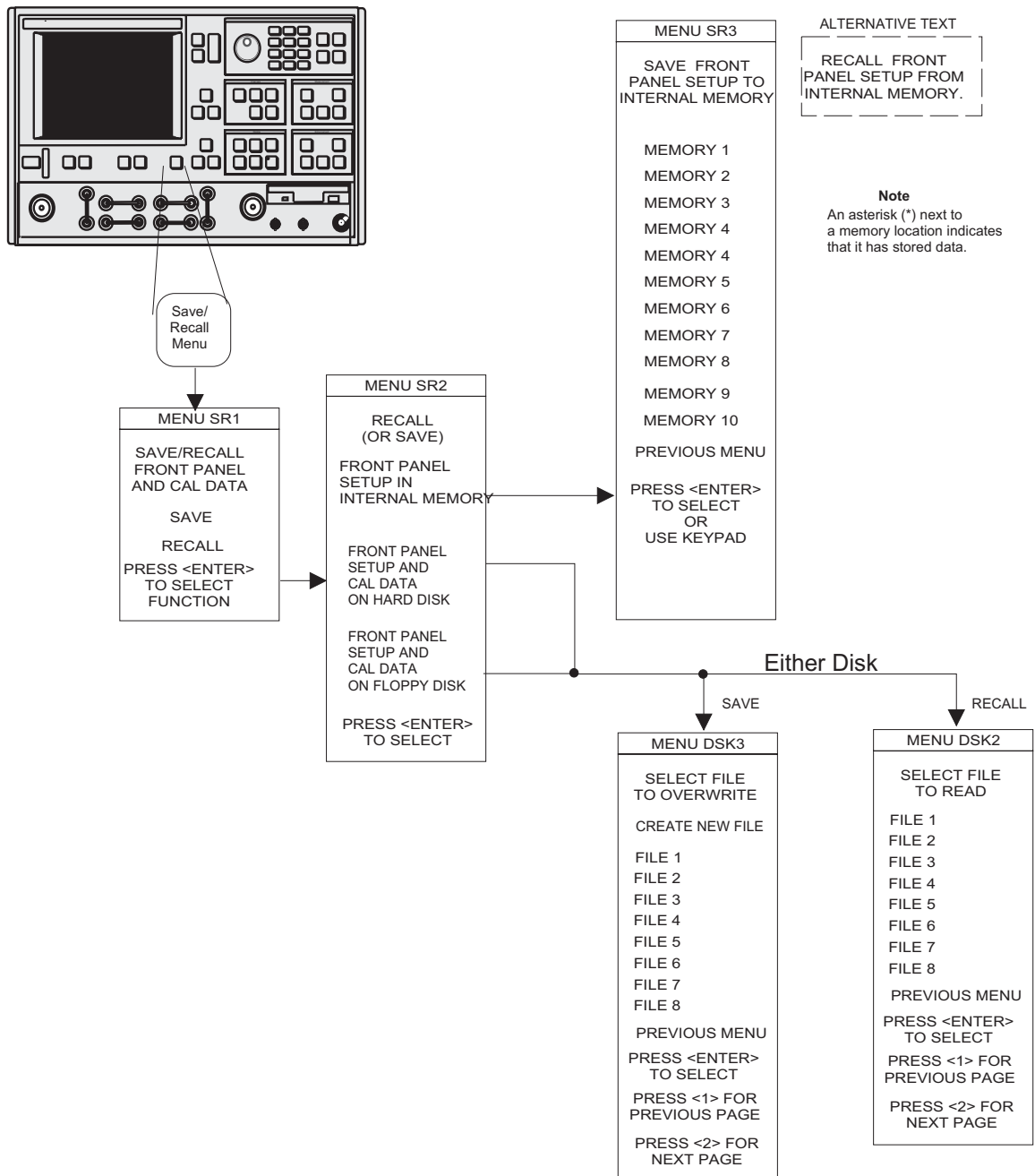


Figure 4-6. Calibration Sequence Menus

**4-4** SAVE/RECALL MENU KEY

Pressing this key displays the first of a menu set (below) that lets you save or recall control panel setups and calibration data. Full menu descriptions can be found in the alphabetically ordered Appendix A under the menu's call letters (SR1, SR2, SR3, etc).



**Figure 4-7** Save/Recall Key-Group Menus

## 4-5 MEASUREMENT KEY-GROUP

The individual keys within the Measurement key-group are described below. Flowcharts of the Setup Key and Data Points key menus are shown in Figure 4-8. As described for the calibration menus, the flow is left-to-right and the double arrowhead lines indicate that the flow returns to the calling menu once a selection has been made. Full menu descriptions can be found in the alphabetically ordered Appendix A under the menu's call letters (SU1, SU2, DF, etc).

**Setup Menu Key:** Pressing this key calls Sweep Setup Menu SU1 or SU3. Depending upon which menu items you select, additional menus may also be called.

**Data Points Key:** Pressing this key calls Menu SU9 or SU9A. Menu SU9 provides for data point selection. Menu SU9A is called if the C.W. MODE selection in Menu SU1 is on.

**Hold Key:** If the instrument is sweeping, pressing this key results in an immediate halt of the sweep at the current data point. The LED on the button lights, indicating that the Hold Mode is active.

If you restart the sweep after performing any recall-from-disk operations in the Hold Mode (sweep stopped at some data point), the sweep restarts from the beginning. The instrument may be taken out of the hold mode as follows:

- By pressing the Default Program key. This causes the 37XXXD to revert to a predefined state
- By pressing the Begin Cal key. This causes the 37XXXD to resume sweeping and begin the Calibration Menu sequence

### **NOTE**

See the description for Menu SU4 for a discussion of the interaction between the Hold Mode and the selection of "Single Sweep" or "Restart Sweep."

**Domain Key:** This key function is fully described in paragraph 4-2 (page 4-8). Additionally, if the Time Domain option is installed, making a selection other than "Frequency Domain" lets you display measured data in the time domain. It also calls a further sequence of Time Domain Menus. Refer to section 9-2 for additional details.

**Appl:** Pressing this key calls a menu that lets you select the following applications: Adapter Removal, Swept Frequency Gain Compression, or Swept Power Gain Compression.

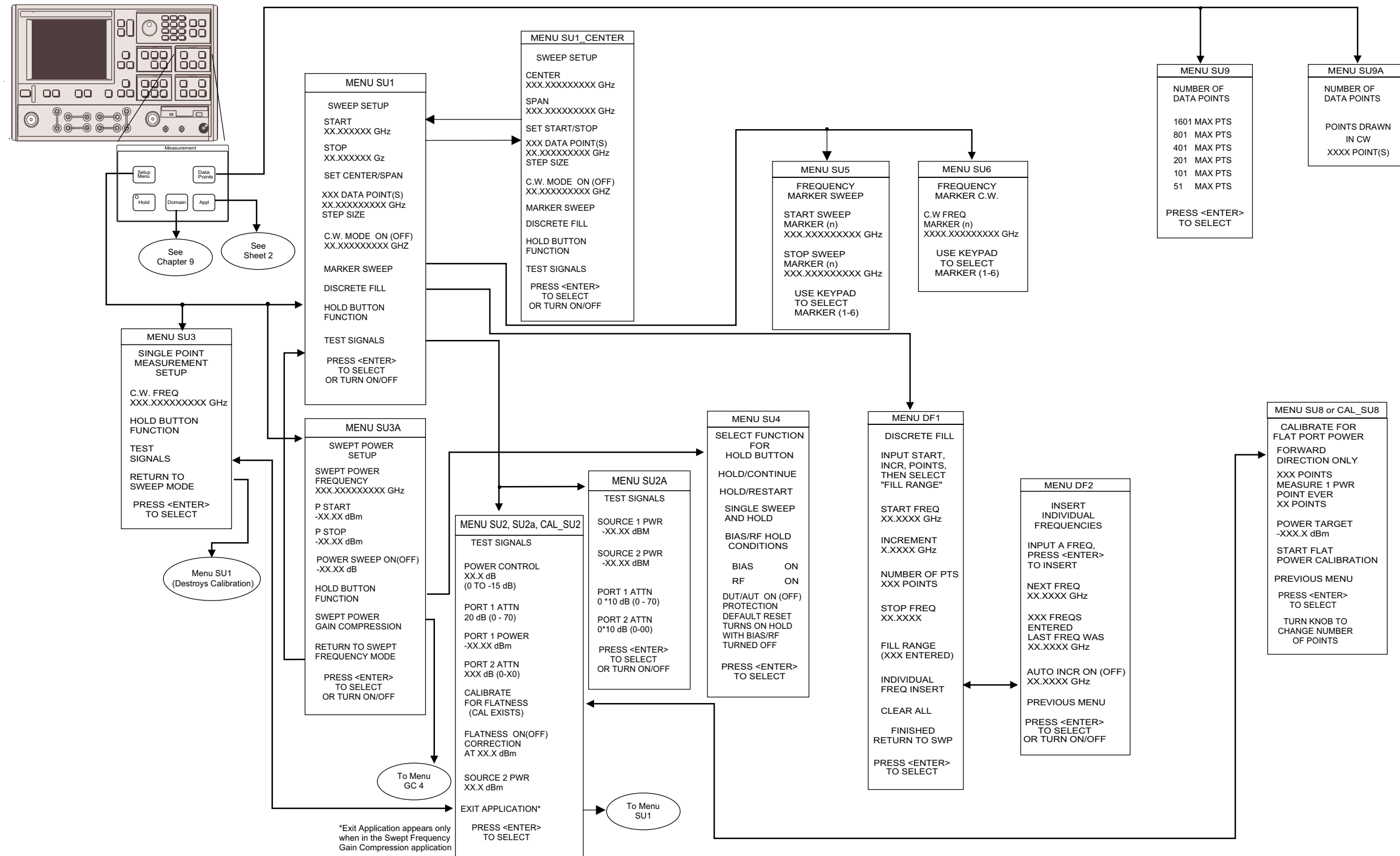


Figure 4-8. Measurement Key-Group Menus Menu Flow (Sheet 1 of 2)



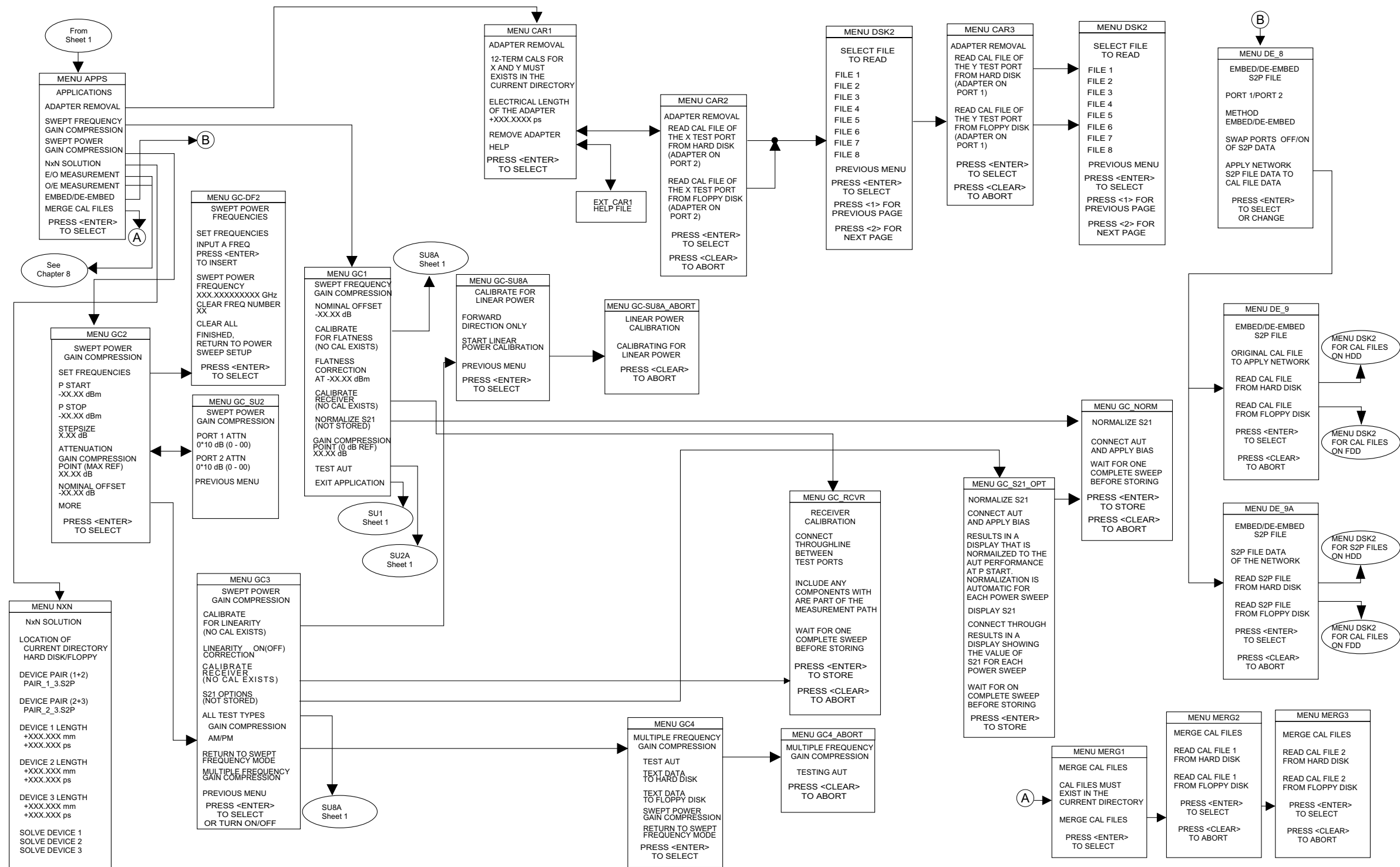


Figure 4-8. Measurement Key-Group Menus Menu Flow (Sheet 2 of 2)

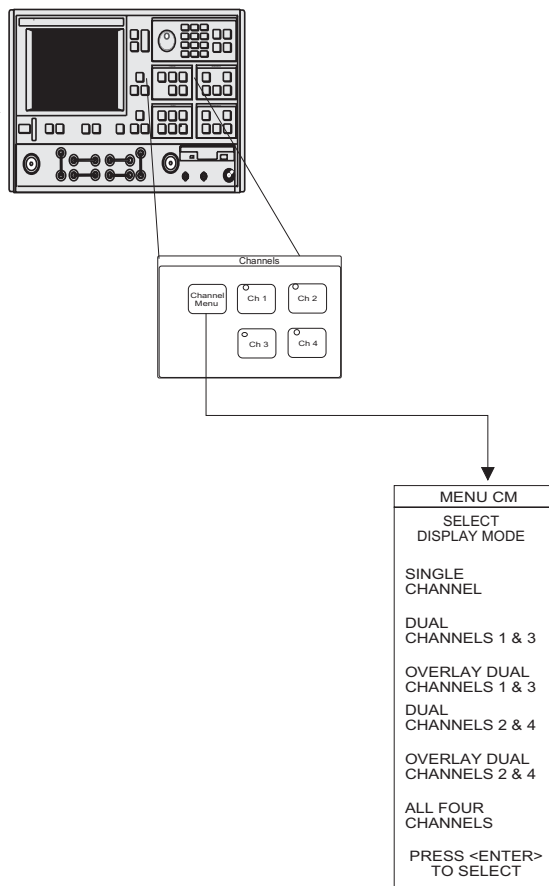
**4-6 CHANNELS KEY-GROUP**

The individual keys within the Channels key-group are described below:

**Ch 1-4 Keys:** These keys (below) define the active channel. One (and only one) must always be active as indicated by the associated LED. Pressing a button makes the indicated channel active. If channel indicated by the key is already active, pressing the key has no effect.

The active channel will be the channel acted upon by the S Params, Graph Type, Ref Plane, Trace Memory, Set Scale, Auto Scale, Markers/Limits and Domain keys. When in the single channel display mode, the active channel will be the one displayed.

**Channel Menu:** Pressing this key calls menu CM (below). Here, you select the number of channels to be displayed. When in the single display mode, only the active channel will be displayed. Full menu description can be found in the alphabetical listing (Appendix A) under the menu's call letters (CM).



**Figure 4-9.** Channel Key-Group Menu

**4-7 DISPLAY KEY-GROUP**

The individual keys within the Display key-group are described below. Menu flow diagrams are shown in Figure 4-10. Full menu description(s) for menu SP and all others mentioned below can be found in the Appendix A alphabetical listing under the menu's call letters (SP, GT1, RD1, etc.).

**Graph Type Key:** Pressing this key calls menu GT1 or GT2. These menus let you select the type of display to appear on the active channel for the selected S-Parameter.

**Set Scale Key:** Pressing this key calls the appropriate scaling menu (SS1, SS2, SS3, etc.) depending upon the graph type being displayed on the active channel for the selected S-Parameter.

**Auto Scale Key:** Pressing this key autoscales the trace or traces for the active channel. The new scaling values are then displayed on the menu (if it is displayed) and graticule. The resolution will be selected from the normal sequence of values you have available using the knob. When the active channel has a Real and Imaginary type display, the larger of the two signals will be used to autoscale both the real and imaginary graphs. Both graphs will be displayed at the same resolution.

**S Params Key:** Pressing this key calls menu SP. This menu allows you to select the S-Parameter to be displayed by the active channel for the selected S-Parameter.

**Ref Plane Key:** Pressing this key calls menu RD1. This menu lets you input the reference plane in time or distance. You do this by selecting the appropriate menu item. For a correct distance readout, the dielectric constant must be set to the correct value. This is accomplished by selecting SET DIELECTRIC, which calls menu RD2.

On menu RD1, selecting AUTO automatically adjusts the reference delay to unwind the phase for the active channel.

The 37XXXD unwinds the phase as follows:

- ❑ First, it sums the phase increments between each pair of measured data points, then it takes the average “Pdelta” over the entire set of points
- ❑ Next, it corrects the phase data by applying the following formula:

$$P_{correct} = P_{measured} - NxP_{delta}$$

Where P = phase

Assuming there are fewer than 360 degrees of phase rotation between each data point, the operation described above removes any net phase offset. The endpoints of the phase display then fall at the same phase value.

**Trace Memory Key:** Pressing this key brings up menu NO1. This menu—which relates to the active channel—allows you to store data to memory, view memory, perform operations with the stored memory, and view both data and memory simultaneously. Four memories exist, one for each channel. This allows each channel to be stored and normalized independent of the other channels. Data from the trace memory may be stored on the disk or recalled from it.

**NOTE**

Trace memory will automatically be set to VIEW DATA (that is, turned off), if a sweep with a greater number of points is selected while operating on a stored trace.

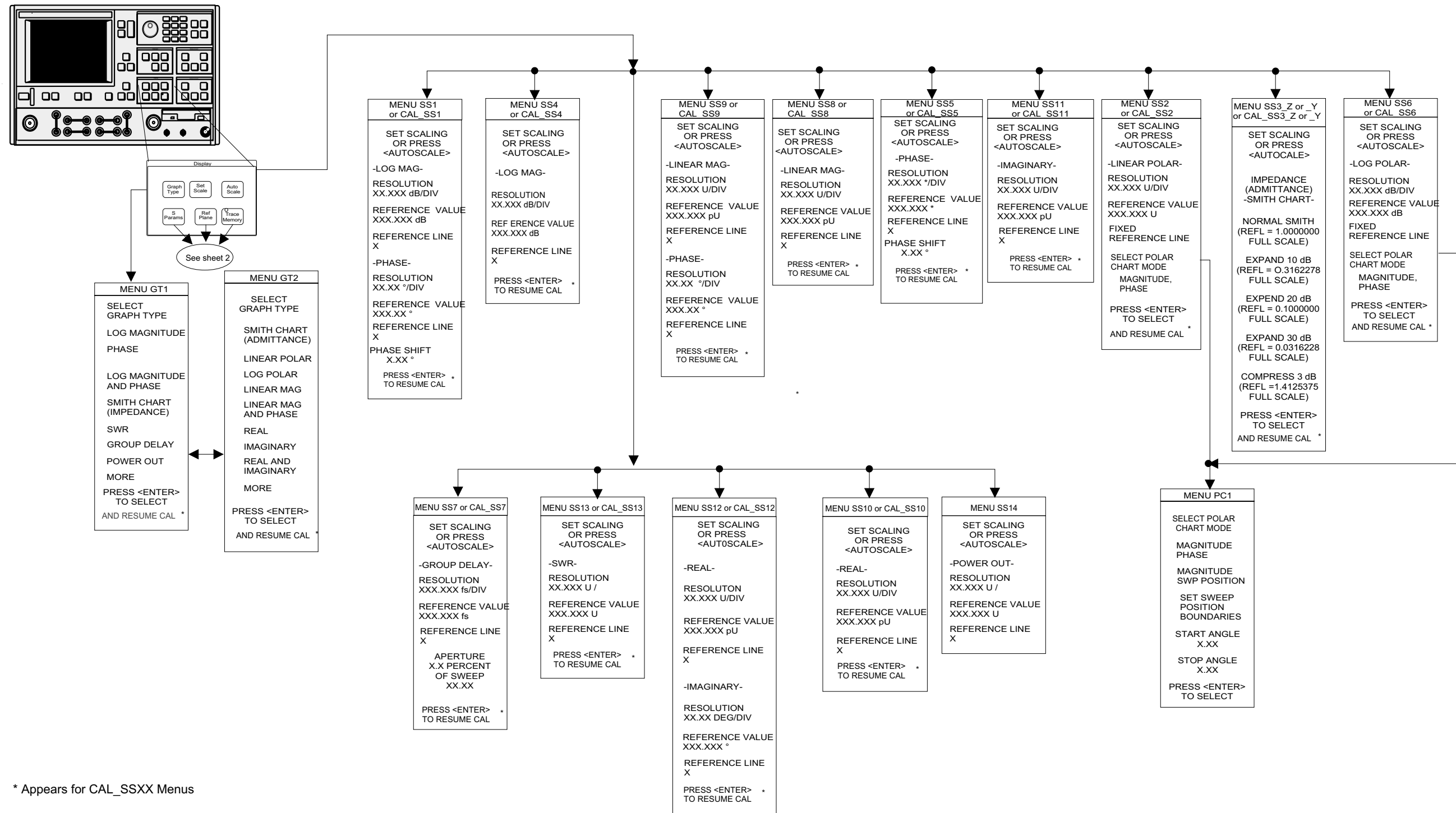


Figure 4-10. Display Key-Group Menus (1 of 2)

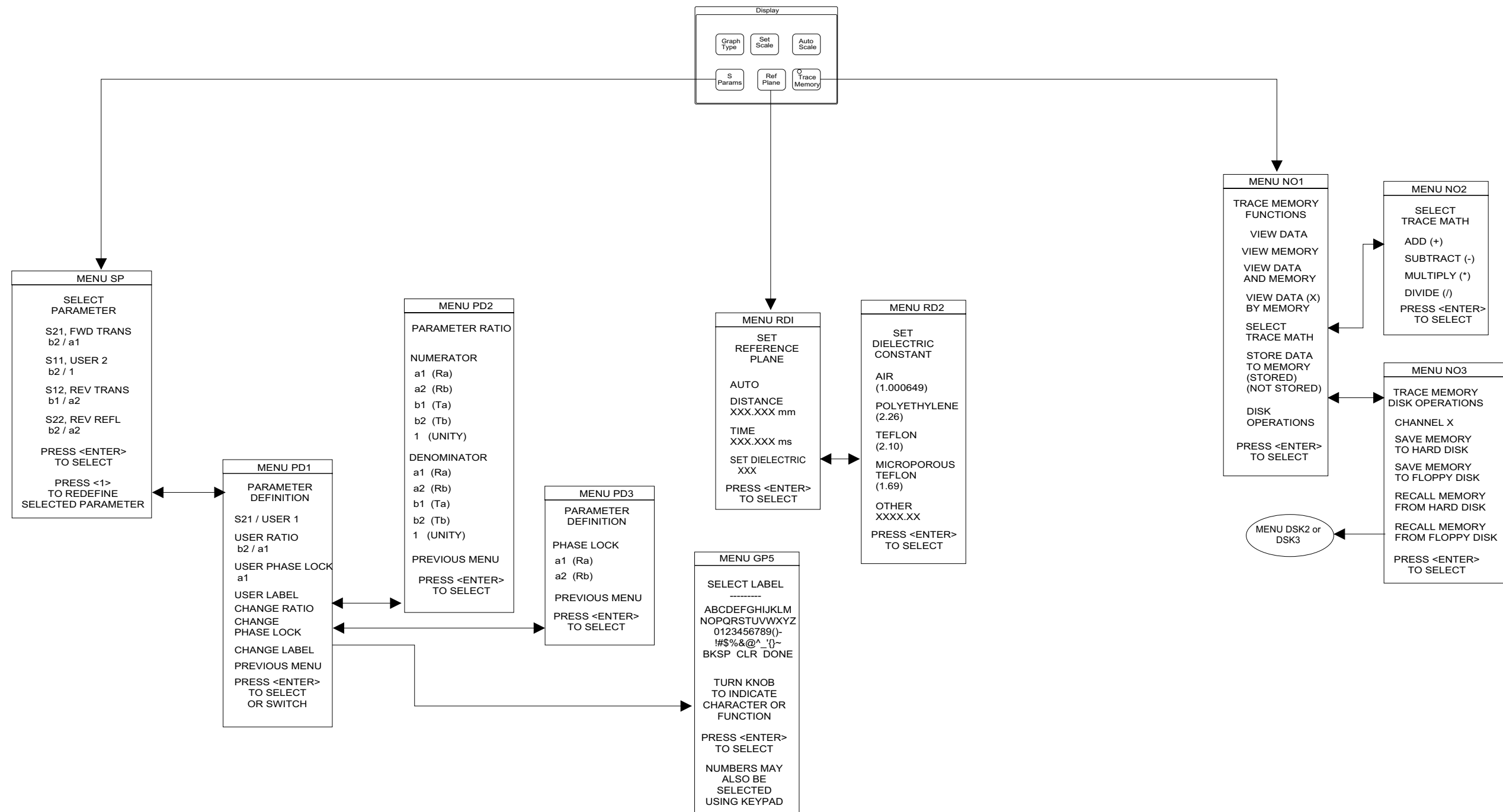


Figure 4-10. Display Key-Group Menus (2 of 2)

**4-8 ENHANCEMENT KEY-GROUP**

The individual keys within the Enhancement key-group are described below. Full menu description(s) for menu OPTNS and all others mentioned below can be found in the Appendix A alphabetical listing under the menu's call letters (OPTNS, EM, CAL\_BW, etc).

**Option Menu Key:** This key brings up the OPTNS menu. Depending on choices selected, this menu causes other menus to appear. A menu flow diagram for this key is shown in Figure 4-12 on the following page.

**Video IF BW Key:** Pressing this produces a menu that lets you choose between four different IF bandwidths. This menu is shown below.

**Avg/Smooth Menu Key:** Pressing this key brings up the EM Menu (Figure 4-11). When pressed during the calibration sequence, it brings up the EM Cal Menu instead. These menus are shown below.

**Trace Smooth and Average Keys:** The Average and Trace Smooth keys set their respective functions on and off with the appropriate LED indicating when the function is selected.

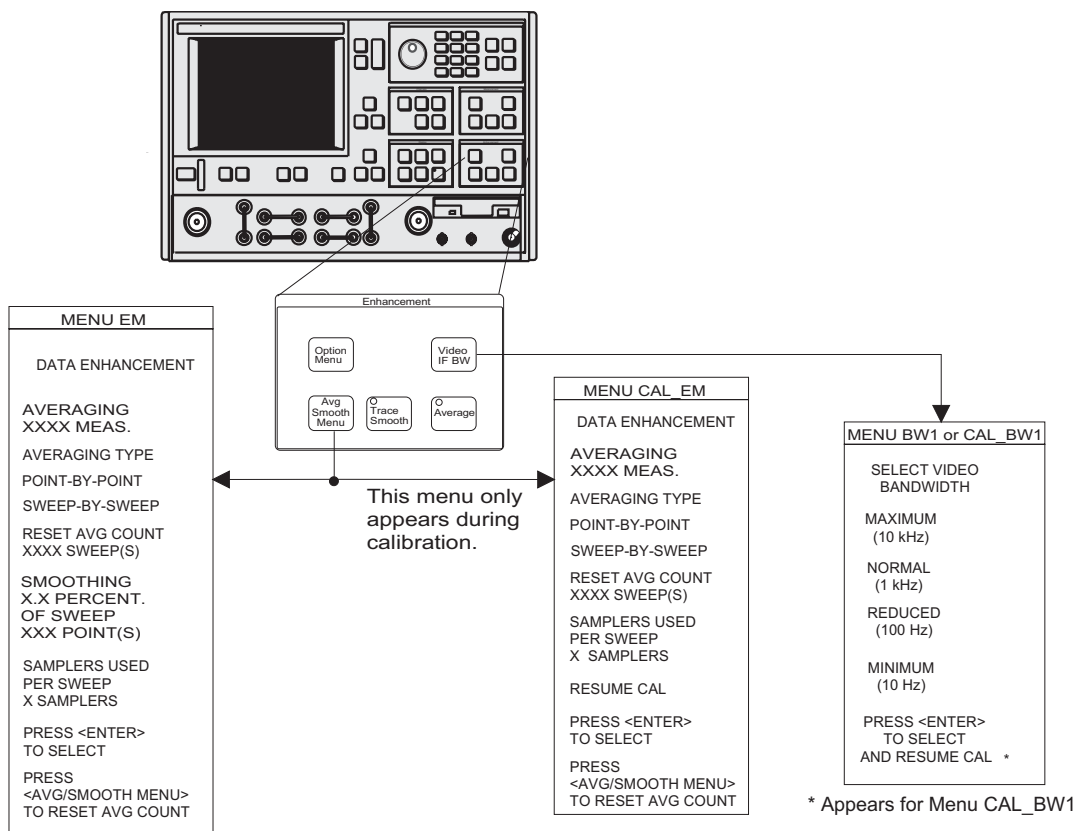


Figure 4-11. Enhancement Key-Group Menus

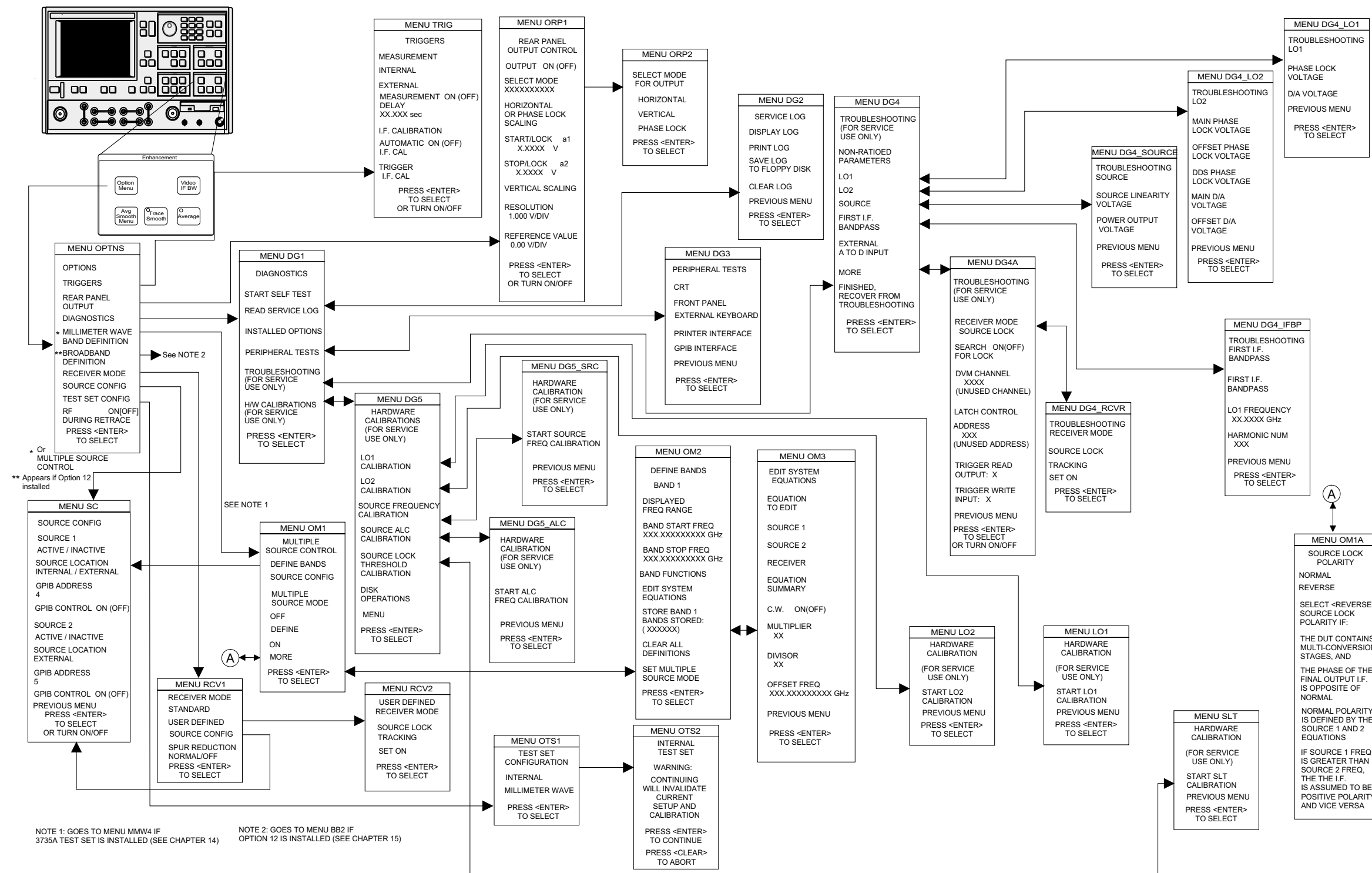


Figure 4-12. Enhancement Key-Group (Options Menu Key)



**4-9 HARD COPY KEY-GROUP**

The individual keys within the Hard Copy key-group are described below. Full descriptions for menus can be found in the alphabetical listing (Appendix A) under the menu's call letters (PM1, PM2, PM3, etc.)

**Menu Key:** Pressing this key brings up menu PM1. This menu allows you to define what will happen every time you press the Start Print key. A menu flow diagram is shown in Figure 4-13.

**Start Print Key:** Pressing this key starts outputting the measured data as defined by the setup defined by the selected MENU key.

**Stop Print Key:** Pressing this key can result in any of the following actions if the printer is selected:

- If the printer is active, the key aborts the printing and sends a form feed command to the printer. Aborting the printing clears the print buffer
- If the printer is not active and another form of output is active, pressing this key aborts printing, but does not send a form feed to the printer

**Plotting Functions:** The 37XXXD can plot an image of either the entire screen or subsets of it. Plots can be either full size or they can be quarter size and located in any of the four quadrants. You can select different pens for plotting different parts of the screen. You cannot, however, plot tabular data.

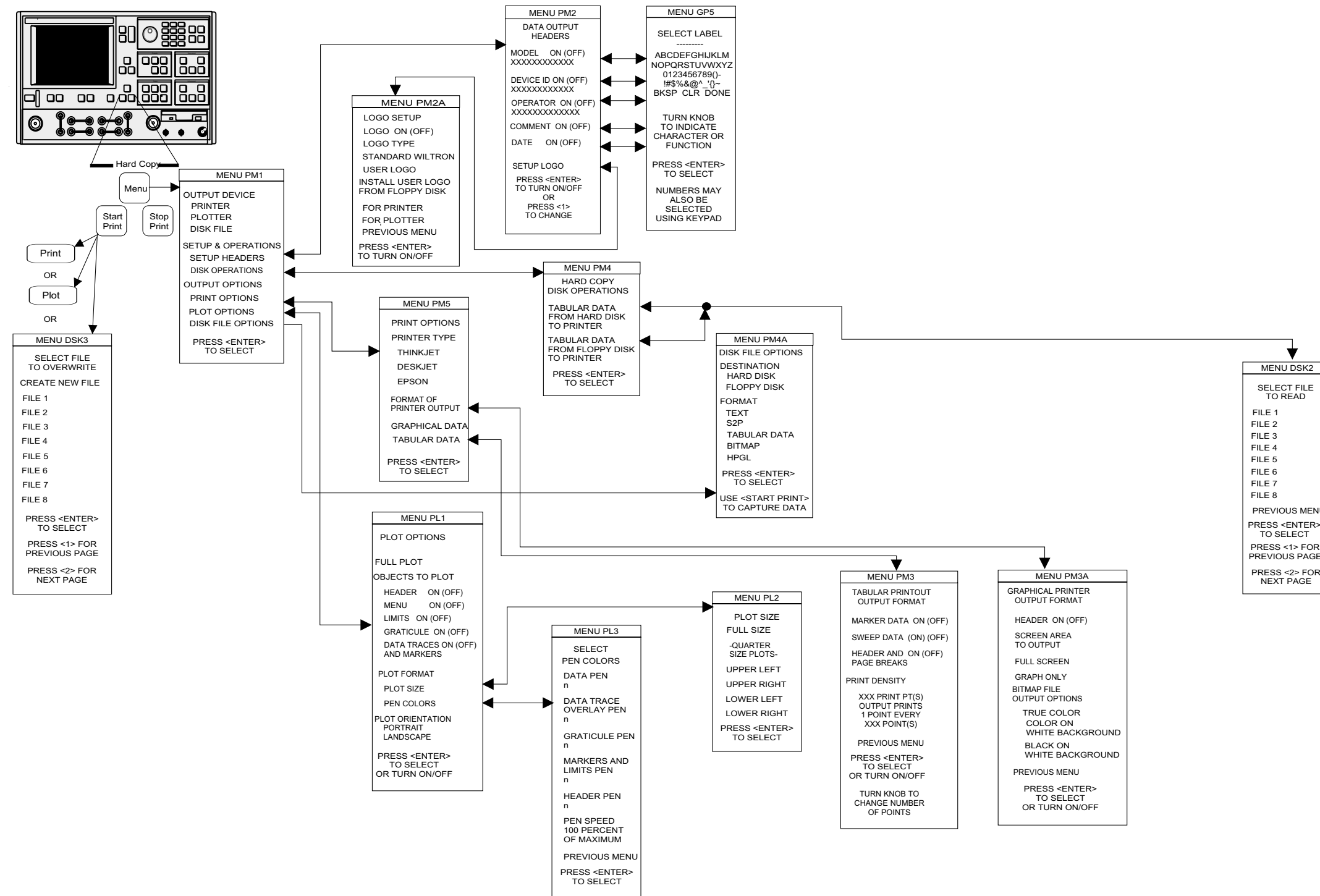


Figure 4-13. Hard Copy Key-Group Menus

**4-10 SYSTEM STATE  
KEY-GROUP**

The individual keys within the System State key-group are described below. The menu flow for the Utility Menu key is shown in Figure 4-14 on page 4-35. Full descriptions for menus can be found in the alphabetical listing (Appendix 1) under the menu's call letters (U1, U2, U3, etc.)

**Default Program Key:** Pressing this key brings up the default menu. If pressed again, it recalls the factory selected default values for the control panel controls. The values are defined in Table 4-2 on the following page.

Pressing this key then the 1 key resets front panel key states and internal memories 1 through 4.

Pressing this key then the 0 key resets front panel key states, internal memories 1 through 10, and certain hardware settings.

**NOTE**

Use of this key will destroy control panel and calibration setup data, unless they have been saved to disk.

**Utility Menu Key:** Pressing this key calls menu U1. This menu accesses subordinate menus to perform system, disk, and system utilities. The only functions performed directly from the U1 Menu are "Blank Frequency Information." and "Data Drawing."

**Table 4-2.** *Default Settings*

<b>Function</b>	<b>Default Setting</b>
Instrument State	Measurement Setup Menu Displayed
Measurement	Maximum sweep range of source and test set <i>Source Power:</i> Model Dependent <i>Resolution:</i> Normal (401 points)
Channel	Quad (four-channel) display Channel 1 active
Display	<i>Channel 1:</i> S11, 1:1 Smith Chart <i>Channel 2:</i> S12, Log Magnitude and Phase <i>Channel 3:</i> S21, Log Magnitude and Phase <i>Channel 4:</i> S22, 1:1 Smith Chart <i>Scale:</i> 10 dB/Division or 90/Division <i>Offset:</i> 0.000dB or 0.00 degree <i>Reference Position:</i> Midscale <i>Electrical Delay:</i> 0.00 seconds <i>Dielectric:</i> Air (1.000649) <i>Normalization:</i> Off <i>Normalization Sets:</i> Erased
Enhancement	<i>Video IF Bandwidth:</i> Normal <i>Averaging:</i> Off <i>Smoothing:</i> Off
Calibration	<i>Correction:</i> Off and Calibration erased <i>Connector:</i> K Connector <i>Load:</i> Broadband
Markers/Limits	<i>Markers On/Off:</i> All off <i>Markers Enabled/Disabled:</i> All enabled Marker Frequency: All set to the start-sweep frequency (or start -time distance) $\Delta$ <i>Reference:</i> Off <i>Limits:</i> All set to reference position value (all off all enabled)
System State	<i>GPIB Addresses:</i> Unchanged <i>Frequency Blanking :</i> Disengaged, <i>Error(s): GPIB SRQ errors are cleared, Service Log errors are not cleared</i> <i>Measurement:</i> Restarted

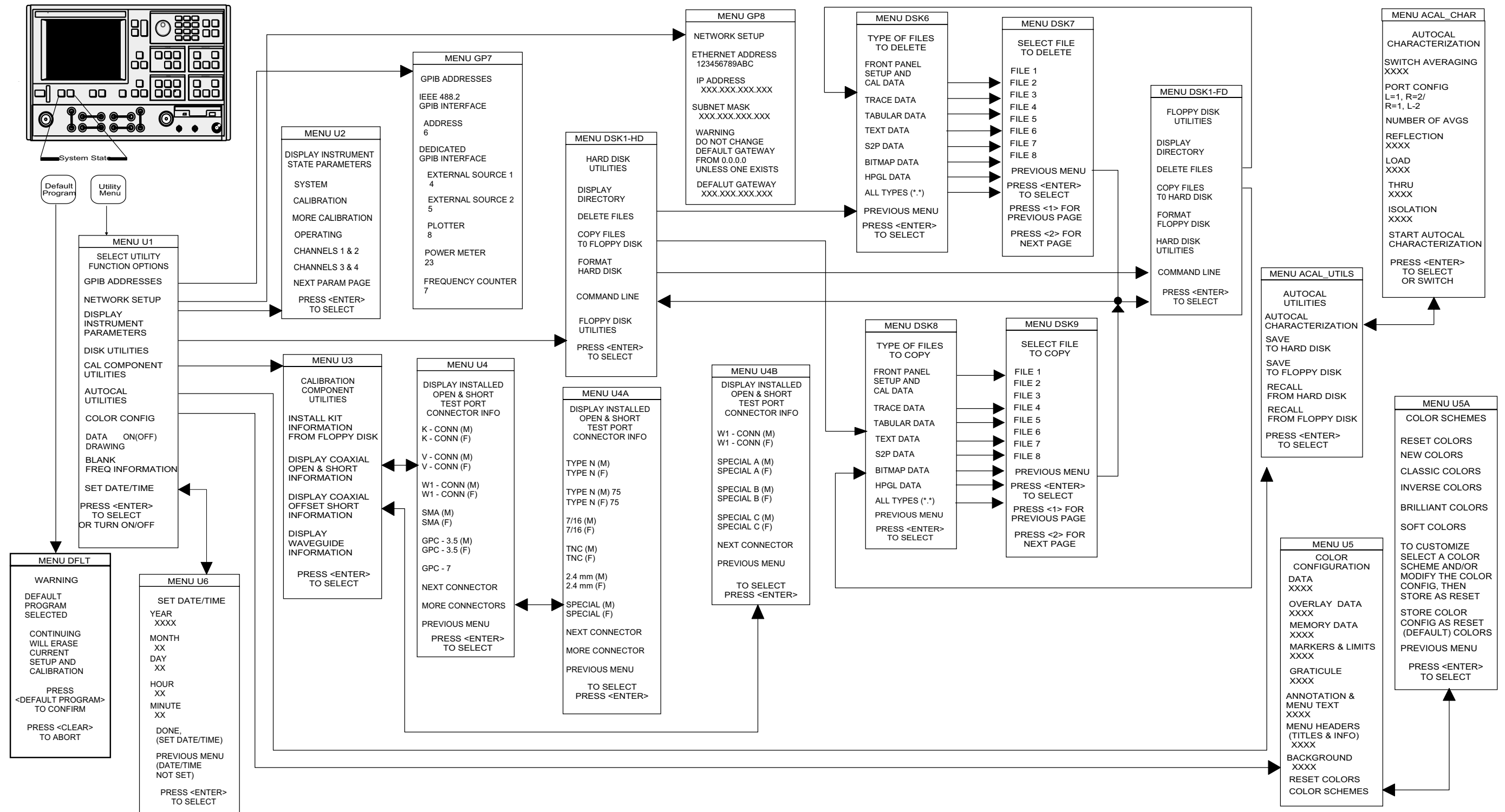


Figure 4-14. System State Key-Group Menus

**4-11 MARKERS/LIMITS  
KEY-GROUP**

The individual keys within the Markers/Limits key-group are described below. The menu flow for the Marker Menu key is shown in Figure 4-15 on the following page. Full descriptions for these menus can be found in the alphabetical listing (Appendix A) under the menu's call letters (M1, M2, M3, etc.)

**Marker Menu Key:** Pressing the Marker Menu key calls Menu M1. This menu lets you toggle markers on and off and set marker frequencies, times, or distances.

**Readout Marker Key:** Pressing this key calls different menus, depending upon front panel key selections, as described below:

- It calls menu M1 if there are no markers available within the selected frequency range
- It calls menu M3 if no Delta ref marker has been selected
- It calls menu M4 if the DReference mode is off and the selected marker is in the current sweep range (or time/distance)
- It calls menu M5 if the DReference mode and marker are both on and the DReference marker is in the selected sweep range (or time/distance)
- It calls menu M6 if ACTIVE MARKER ON ALL CHANNELS has been previously selected in menu M9
- It calls menu M7 if SEARCH has been previously selected in menu M9
- It calls menu M8 if FILTER PARAMETER has been previously selected in menu M9

**Limits Key:** Pressing this key calls the appropriate Limit menu based on the graph type selected using the Graph Type key and menu.

**Marker Readout Functions:** This menu choice, which appears on several marker menus, provides for several filter-related measurements. It also allows for performing a marker-value search and for reading the active marker value on all displayed channels.

**Limit Frequency Readout Function:** The 37XXXD has a Limit-Frequency Readout function. This function allows frequency values to be read at a specified level (such as the 3 dB point) on the data trace. This function is available for all rectilinear graph-types.

The graph-type and their menu call letters are listed below:

- |   |  |
|---|--|
| <input type="checkbox"/> Log Magnitude, Menu LF1    | <input type="checkbox"/> Imaginary, Menu LF7 |
| <input type="checkbox"/> Phase, Menu LF2            | <input type="checkbox"/> Power Out, Menu LF8 |
| <input type="checkbox"/> Group Delay, Menu LF3      | <input type="checkbox"/> Real, Menu LF6      |
| <input type="checkbox"/> Linear Magnitude, Menu LF4 | <input type="checkbox"/> Imaginary, Menu LF7 |
| <input type="checkbox"/> SWR, Menu LF5              | <input type="checkbox"/> Power Out, Menu LF8 |
| <input type="checkbox"/> Real, Menu LF6             |  |

**NOTE**

Full menu descriptions can be found in the alphabetical listing (Appendix A) under the menu call letters (LF1, LF2, LF3, etc.)

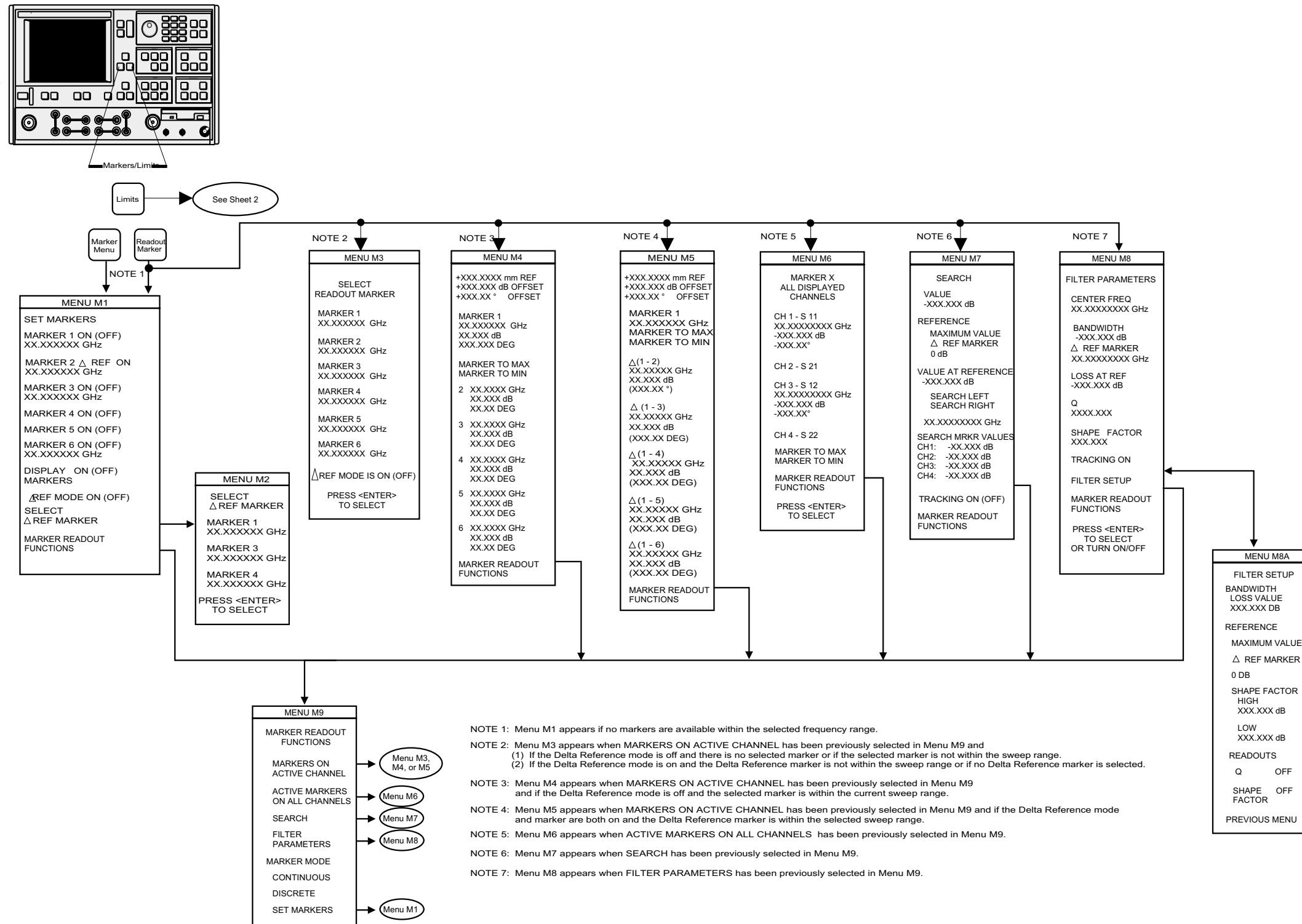
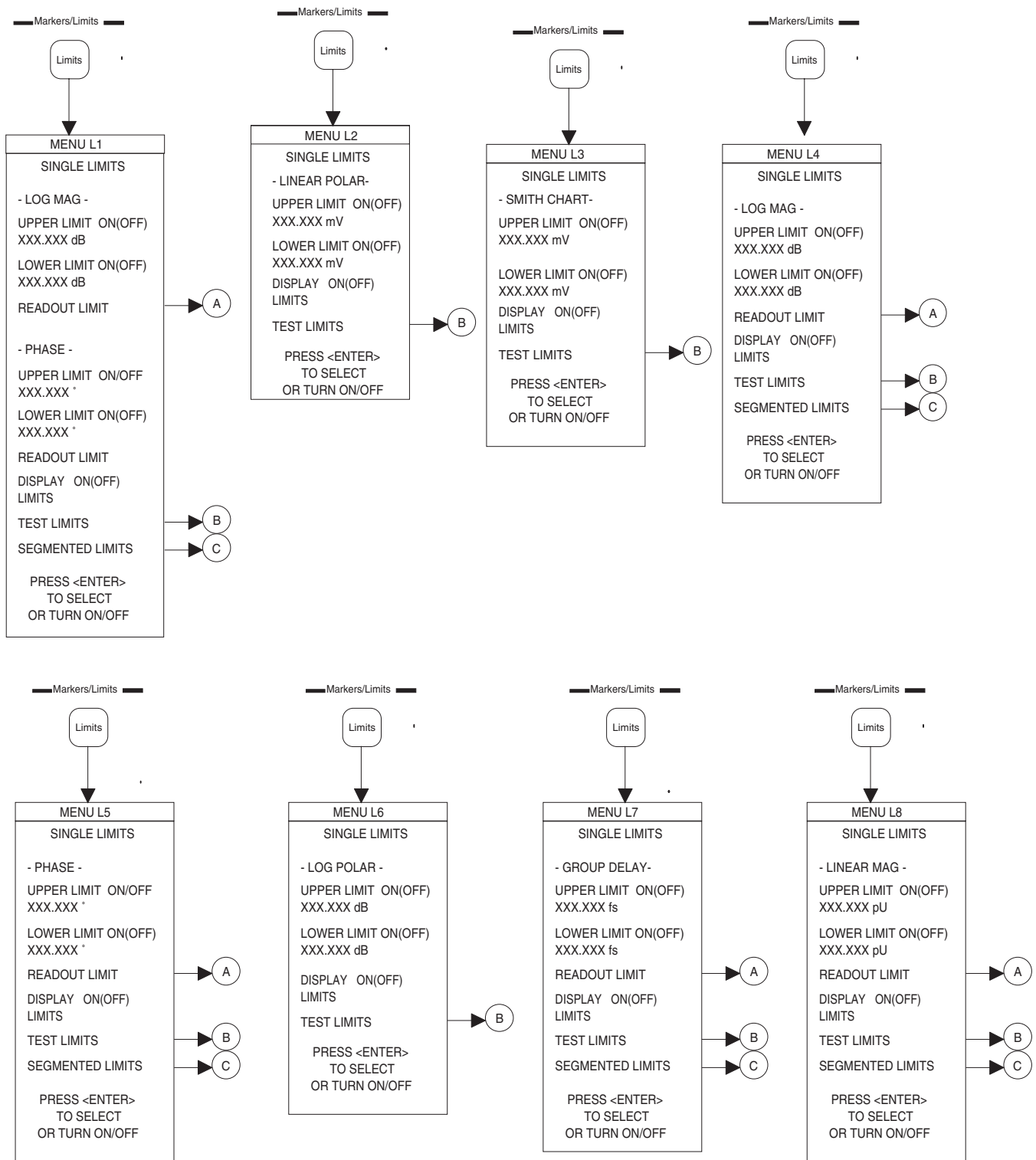


Figure 4-15. Markers Menus (1 of 3)



**Figure 4-15.** Markers/Limits Key-Group Menus (2 of 3)



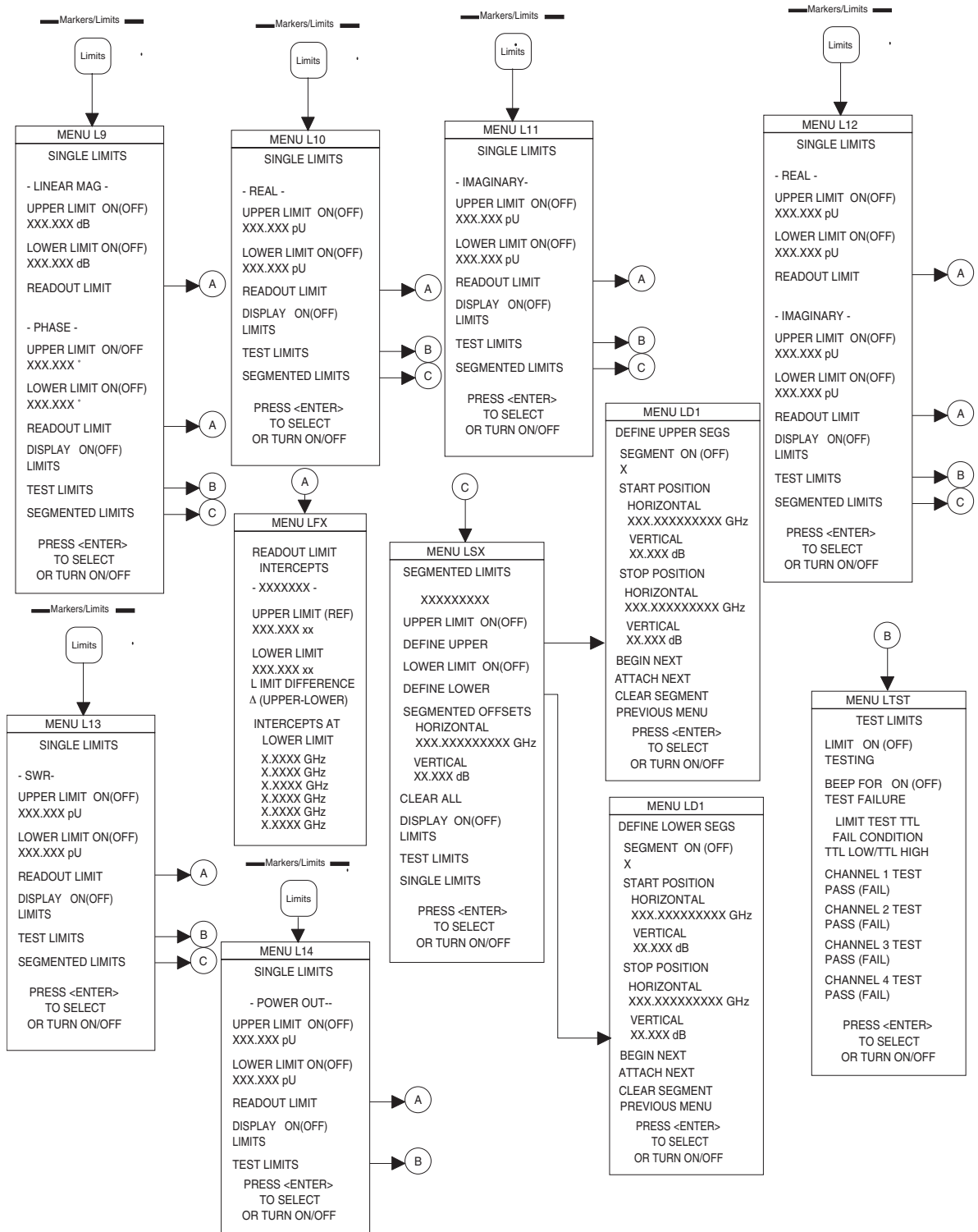


Figure 4-15. Markers/Limits Key-Group Menus (3 of 3)

## 4-12 DISK STORAGE INTERFACE

The 37XXXD has two internally mounted disk drives: an 80 MB hard disk and a 3.5 inch floppy. The format, files, and directory are compatible with MS-DOS, Version 5.0 and above.

### **Disk Format**

Floppy diskettes are MS-DOS compatible and have a 1.44 MByte capacity.

### **Disk Files**

You may find any of the following file-types on the 37XXXD disk:

- Program Files: These are binary files used to load the operating program. They are provided on the hard drive, and a backup copy is provided on floppy diskettes. Application programs cannot read them
- Calibration Data Files: These are binary files used to store and retrieve calibration and other data. Application programs cannot read them. File size depends on calibration type
- Text Files: These are tab-delimited ASCII files with the "txt" file extension. They can be read by application programs
- S2P Parameter Data Files: These files define a 2-port file format that includes all four S parameters. They can be read by applications programs. They have a file extension of "S2P"
- Tabular Measurement Data Files: These are ASCII files used to store actual measurement data. They can be read by applications programs. File size depends on selected options
- Trace Memory Files: These are binary files used to store trace data. Applications programs cannot read them. You use them to perform trace math operations on data
- Cal Kit File for Coax or Waveguide
- AutoCal Characterization file

#### **NOTE**

File names must begin with alphabetical, not numeric characters.

***Disk File Output Device***

You can select the output drive destination for the disk file as either the hard disk (C:) or the floppy drive (A:). The format of the disk file is also selected. The default condition is text disk file to the hard disk.

You may then proceed with normal measurements. The Start Print key may then be used at the instant you intend to capture the data. Menu DISK 3 then appears and allows the creation of a new file or to overwrite an existing file in the current directory.

Note that the output for text and S2P files have predefined formats. Tabular data format is configured via the Print Options (Menu PM5) or Tabular Data (Menu PM3). Bitmap format is configured via the Print Options (Menu PM5), Options (Menu PM5, or Graphical Data (Menu PM3A). HPGL format is configured via the Plot Options (Menu PL1).

You are able to direct hard copy output to the HDD or floppy, in addition to the printer and plotter. In addition to text (\*.txt), S2P (\*.s2p), and tabular (\*.dat) files, bitmaps (\*.bmp) and HPGL (\*.hgl) files are offered to satisfy your desktop publishing requirements. Specifically, color bitmaps and graphic language files can be imported into Windows applications, such as Cap3700.

***Formatting a Data File Disk***

You may format additional diskettes to hold calibration, tabular measurement, and trace-memory data files. Do this using the FORMAT DISK selection on the "Floppy Disk Utilities" menu. Using this selection will format the target disk and overwrite any existing data it contains.

A format hard disk utility is provided in case of hard disk failure. Using this feature overwrites your system software and requires booting from the backup floppy diskettes.

***Copying Data Files From Disk to Disk***

Use the COPY FILES selection on the "Floppy Disk Utilities" and "Hard Disk Utilities" menus to copy data files between hard and floppy diskettes.

***Recovering From Disk Write/Read Errors***

If you experience a read or write error during a disk operation, you should:

- Verify first character of filename is alphabetical and not numeric
- Verify that the diskette has been properly formatted
- Verify that the diskette is high density (1.44 MB). Low density (720 KB) diskettes are not supported
- Verify that the write-protect tab on the disk is engaged
- Retry the disk operation

Repeated disk errors may indicate a defective diskette and format.

**4-13** COMMAND LINE

The Command Line menu choice provides several DOS compatible commands. Command line options are:

- CREATE DIRECTORY (MD)
- LIST DIRECTORY (DIR)
- CHANGE DIRECTORY (CD)
- DELETE FILES (DEL)
- REMOVE DIRECTORY (RD)
- COPY FILES (COPY)

These options are NOT case sensitive.

**Create Directory**

This command is performed by: MD c:\pat-h\dir\_name or MD a:\path\dir\_name. The c: is used to refer to the hard disk, and a: is for the floppy disk.

**List Directory**

This command is performed by "DIR" command. This may be used as DIR c:\path or without any path specified. The syntax is:

DIR c:\path or DIR a:\path.

If c: or a: is not used, the default is the current hard disk directory. You may use wild cards as follows:

- DIR \*.cal
- DIR filter?.cal

**Change Directory**

This command is performed by CD c:\path or CD a:\path. Both of these options do not require a device name. The device name is referred to by c: or a:.

If you choose to do CD dir\_name, this implies the current Hard disk directory.

**Delete Files**

This command is used to delete a particular file(s) in a directory, or delete the entire contents of the directory by using the wild card option. The command line is:

- DEL filename
- DEL c:\path\filename
- DEL a:\path\\*

***Remove Directory***

This command is used to delete a particular directory. The command is only valid when the entire directory is empty:

- RD c:\path\directory
- RD a:\path\directory

***Copy Files***

This command is performed by the command line COPY source: destination:

COPY c:\path\name a:\path\name

Any combination of the drive is allowed, except for the same directory, and the same name.


Once the COMMAND LINE is selected, the system will prompt a one line dialog box to allow command entry. The dialog box remains open only for the user interface.


***Conventions***

Be aware of the following conventions when using the Command Line choice. There is a limitation of five sublevel directories in the 37XXXD models:

- Any directory change will force the system to use that as the current directory for other menus that deal with the file system. For example, if the user changes the directory to c:\lib\junk, then any activity for saving hard copy or calibration files will be saved on the junk directory.
- The default directory is the root directory.
- GPIB support: GPIB mnemonics will provide functionality for each of the above operations. The format is shown below:

Function	Path
List directory	DIR "[device:]"
Make directory	MD "[device:][path]name"
Change directory	CD "[device:][path]nopath]nameme"
Delete File(s)	DEL "[device:][path]name"
Remove directory	RD "[device:][path]name"
Copy files	COPY "[device:][path/][source]" "[device:][path/][destination]"

 Vector Network Analyzer Clear/Ret Loc _____ Esc Start Print _____ Print Screen, F12 Hold _____ Pause <small>Copyright (c) 1994-98 by Anritsu Company</small>	Default Program Avg/Smooth Menu	Trace Smooth	Utility Menu	Options Menu	<i>Ctrl</i>	Command Line	Recall	Recall CAL from HDD	Recall NRM from HDD	<i>Ctrl</i>	Save TXT to Floppy	Save S2P to Floppy	Save DAT to Floppy	Hardcopy Menu
	Channel Menu	Marker Menu	Average Readout Marker	Video IF BW Limits	<i>Alt</i>	S Params	Save	Save CAL to HDD	Save NRM to HDD	<i>Alt</i>	Save TXT to HDD	Save S2P to HDD	Save DAT to HDD	
	Ch 1	Ch 2	Ch 3	Ch 4	<i>Shift</i>	Graph Type	Set Scale	Ref Plane	Trace Memory	<i>Shift</i>	Domain	Applications	Begin Cal	Stop Print
							Auto Scale	Auto Ref Plane	Store Data to Memory		Setup Menu	Data Points	Apply Cal	Start Print
	F1	F2	F3	F4		F5	F6	F7	F8		F9	F10	F11	F12

 Vector Network Analyzer Clear/Ret Loc _____ Esc Start Print _____ Print Screen, F12 Hold _____ Pause <small>Copyright (c) 1994-98 by Anritsu Company</small>	<i>Ctrl</i>	Default Program Avg/Smooth Menu	Trace Smooth	Utility Menu	Options Menu	Command Line	Recall	Recall CAL from HDD	Recall NRM from HDD	Save TXT to Floppy	Save S2P to Floppy	Save DAT to Floppy	Hardcopy Menu	<i>Ctrl</i>
	<i>Alt</i>	Channel Menu	Marker Menu	Average Readout Marker	Video IF BW Limits	S Params	Save	Save CAL to HDD	Save NRM to HDD	Save TXT to HDD	Save S2P to HDD	Save DAT to HDD		
	<i>Shift</i>	Ch 1	Ch 2	Ch 3	Ch 4	Graph Type	Set Scale	Ref Plane	Trace Memory	Domain	Applications	Begin Cal	Stop Print	<i>Alt</i>
							Auto Scale	Auto Ref Plane	Store Data to Memory	Setup Menu	Data Points	Apply Cal	Start Print	<i>Shift</i>
		F1	F2	F3	F4	F5	F6	F7	F8	F9	F10	F11	F12	

Actual-Size Keyboard Templates for 37XXXD

# **Chapter 5**

## **Error and Status**

### **Table of Contents**

---

5-1	INTRODUCTION . . . . .	5-3
5-2	ERROR MESSAGES. . . . .	5-3





# Chapter 5

## Error and Status Messages

### 5-1 INTRODUCTION

This chapter lists, describes, and provides corrective action for the error messages that point to problems that the operator can correct. Any error messages that appear on the display but do not appear in this chapter will require action by a qualified service representative.

### 5-2 ERROR MESSAGES

Error messages are provided in Tables 5-1 and 5-2.

**Table 5-1.** General Error Messages (1 of 3)

Error Message	Description	Corrective Action
ATTENUATOR UNAVAILABLE	Option 6 Port 2 Test Step Attenuator is not installed.	Install Option 6 Step Attenuator,
BANDS MUST SEQUENCE	Frequency bands in Multiple Source mode must sequence in a 1-2-3-4-5 order.	None, no skipping is allowed.
BOTH LIMITS MUST BE ON	Must have both limits activated.	Turn on limits.
DIFFERENT H/W SETUP. RECALL ABORTED	Source is different from the recalled setup.	Reconfigure system to duplicate the hardware setup that was used to store the saved data.
DIFFERENT S/W VERSION, RECALL ABORTED	Saved state not compatible with hardware or software version.	Load compatible software (S/W) version and retry.
DISCRETE FREQS LOST	Change in frequency caused discrete fill frequencies to be lost.	None.
DISPERSIVE MEDIUM, ONLY TIME USED	Distance does not apply for dispersive media.	None.
FREQUENCIES HAVE REACHED UPPER LIMIT	Frequencies being defined in Multiple Source mode have reached upper limits of Sources.	Redefine frequencies to not exceed limits of Sources.
ILLEGAL IN C.W. MODE	Attempted to readout limit frequency.	None, no limit lines are permitted in CW mode.
ILLEGAL IN TIME DOMAIN	Attempted to readout limit frequency	None.
LOGO FILE NOT FOUND	Attempted to read a non-existent logo file from disk.	Create user-defined logo using application on external controller.
MEAS DATA NOT AVAILABLE FOR STORAGE	Measurement data is not available for storage on floppy or hard disk.	None.
MEMORY LOCATION CORRUPTED	Requested memory location is corrupted.	None. If problem reoccurs after storing a new setup, contact Anritsu Customer Service.
NO BANDS ARE STORED	No frequency bands have been defined and stored.	Need to define and store frequency bands to turn on Multiple Source mode.

**Table 5-1.** *General Error Messages (2 of 3)*

<b>Error Message</b>	<b>Description</b>	<b>Corrective Action</b>
NO STORED MEMORY DATA	No data is stored in floppy or hard disk memory.	None.
OPTION NOT INSTALLED	Selected an option that is not installed.	None.
OUT OF CAL RANGE	Entered values out of the selected calibration range.	Change calibration range or re-enter values that are within the current range.
OUT OF H/W RANGE	Entered value is out of the instrument's hardware range.	Re-enter values that are within range.
OUT OF RANGE	Entered value is out of range.	Re-enter values that are within range.
OUT OF RANGE, 10 PERCENT MIN	Entered value is out of the instrument's range by greater than 10 percent.	Re-enter frequency or power value.
OUT OF RANGE, 20 PERCENT MAX	Entered smoothing or group delay value exceeds the range by greater than 20 percent.	Re-enter values that are within range, 0 to 20%.
OUT OF SWEEP RANGE	Entered a frequency that is out of the instrument sweep range.	Re-enter frequency.
OUT OF WINDOW RANGE	Attempted to set marker outside start to stop range.	Redefine marker to be within frequency start/stop range.
POWER OUT OF CALIBRATED RANGE	Power range has been changed to be outside the range of the active linearity calibration. Linearity calibration is turned off.	Perform linearity calibration over new power range.
POWER RESTORED TO CAL RANGE	Power range is outside of the linearity calibration range when the calibration was turned on. The power range is changed to the calibration range.	If new power range is desired, perform new linearity calibration over new power range.
RECEIVER OUT OF RANGE BY EQUATION	Equation defined in Multiple Source mode places receiver frequency out of range when attempting to store band.	Redefine frequency.
SOURCE 1 OUT OF RANGE BY EQUATION	Equation defined in Multiple Source mode places Source 1 frequency out of range when attempting to store band.	Redefine frequency.
SOURCE 2 OUT OF RANGE BY EQUATION	Equation defined in Multiple Source mode places Source 2 frequency out of range when attempting to store band.	Redefine frequency.
STANDARD CAL NOT VALID FOR WAVEGUIDE	Cannot use waveguide when calibrating with the standard method.	Use the Offset Short method with waveguide.
START F FOLLOWS PREVIOUS STOP F	Start frequency of current band immediately follows stop frequency of previous band. Cannot be modified.	None.
START GREATER THAN STOP	Entered start frequency is greater than the stop frequency.	Re-enter frequency values such that the start frequency is lower than the stop frequency.
START MUST BE LESS THAN STOP	Entered start frequency is greater than the stop frequency.	Re-enter frequency values such that the start frequency is lower than the stop frequency.
STEP IS TOO LARGE	Entered discrete fill step extends the stop fill out of range.	Re-enter so that step is within range.

**Table 5-1.** *General Error Messages (3 of 3)*

<b>Error Message</b>	<b>Description</b>	<b>Corrective Action</b>
STOP IS OVER RANGE	Entered value exceeds the instrument's stop frequency.	Re-enter stop frequency.
SYSTEM BUS ADDRESSES MUST BE UNIQUE	GPIB address is being used by another bus instrument.	Select a different, unique GPIB address.
SYSTEM UNCALIBRATED	37XXXD is uncalibrated for the selected measurement values.	Perform a measurement calibration.
TOO FEW POINTS, 2 MINIMUM	Entered too few discrete file points, 2 is minimum.	Re-enter data points.
TOO MANY POINTS, 1601 MAXIMUM	Entered too many discrete file points, 1601 points are the maximum allowed.	Re-enter data points.
UNDEFINED DIVIDE BY ZERO	Denominator cannot be zero in equation.	Make denominator a value other than zero.
WARNING: NO GPIB CONTROL OF SOURCE SWEEP	Neither Source power nor flat-port power can be modified when receiver mode is user-defined with NO Source GPIB control.	None.
WARNING: SET ON RECEIVER MODE	Phase-lock setting is undefined when VNA is Set-On Receiver mode.	None.
WARNING: SOURCE 2 DOES NOT EXIST	2nd, external, frequency source is not present.	Connect frequency source.
WINDOW TOO SMALL	Attempted to set start greater than or equal to stop.	Re-enter frequency values.

**Table 5-2.** *Disk Error Messages*

<b>Error Message</b>	<b>Description</b>	<b>Corrective Action</b>
7140: FLOPPY DISK GENERAL ERROR	Invalid disk media or format.	Use 1.44 MB diskette and format in the 37XXXD.
7142: FLOPPY DISK READ ERROR	Read error when accessing disk file.	Use 1.44 MB diskette and format in the 37XXXD.
7143: DISK WRITE ERROR	Error in writing to disk file.	Use 1.44 MB diskette and format in the 37XXXD.
7147: FLOPPY DISK UNAVAILABLE	Floppy disk is not available.	Install floppy diskette or floppy disk drive.
7170: HARD DISK GENERAL ERROR	General error in accessing hard disk.	Retry and if still fails, reformat the hard disk drive.
7172: HARD DISK READ ERROR	Read error when accessing disk file.	Retry and if still fails, reformat the hard disk drive.
7173: HARD DISK WRITE ERROR	Error in writing to disk file.	Retry and if still fails, reformat the hard disk drive.
7177: HARD DISK UNAVAILABLE	Hard disk is not available.	Install hard disk drive circuit board.
8140: GENERAL DISK BUFFER ERROR	Out of RAM.	Press the System State, Default Program key and retry.
FILE NOT FOUND	Disk file not found.	None.
FLOPPY DISK HAS NO ROOM FOR FILE	Floppy diskette is full.	Delete files or install new diskette.
FLOPPY DISK NOT READY	Floppy disk is not ready (or not installed.).	Install diskette in floppy drive.
FLOPPY DISK WRITE PROTECTED	Write protect tab in place on floppy diskette.	Remove write-protect tab.
HARD DISK HAS NO ROOM FOR FILE, DELETE EXISTING FILES(S) TO CREATE SPACE	Hard disk is full.	Delete files.

# Chapter 6

## Data Displays

### Table of Contents

---

6-1	INTRODUCTION . . . . .	6-3
6-2	DISPLAY MODES AND TYPES . . . . .	6-3
	Single Channel Display: Ch 1, 2, 3, 4. . . . .	6-3
	Dual Channel Display: Ch 1 and 3 or Ch 2 and 4 . . . . .	6-4
	Four Channel Display: Ch 1, 2, 3, 4 . . . . .	6-5
	Dual Trace Overlay . . . . .	6-6
	Graph Data Types. . . . .	6-7
6-3	FREQUENCY MARKERS . . . . .	6-11
	Marker Designation . . . . .	6-11
6-4	LIMITS . . . . .	6-11
6-5	STATUS DISPLAY . . . . .	6-12
	Reference Position Marker . . . . .	6-12
	Scale Resolution . . . . .	6-12
	Frequency Range . . . . .	6-12
	Analog Instrument Status. . . . .	6-12
	Measurement Status . . . . .	6-13
	Sweep Indicator Marker. . . . .	6-13
6-6	DATA DISPLAY CONTROL . . . . .	6-13
	S-parameter Selection . . . . .	6-14
	Data Display Update . . . . .	6-14
	Display of Markers. . . . .	6-14
6-7	HARD COPY AND DISK OUTPUT . . . . .	6-15
	Tabular Printout . . . . .	6-15
	Screen-Image Printout . . . . .	6-15
	Plotter Output . . . . .	6-15
	Disk Output . . . . .	6-15



# Chapter 6

## Data Displays

### 6-1 INTRODUCTION

This chapter provides discussion and examples of the various types of data displays.

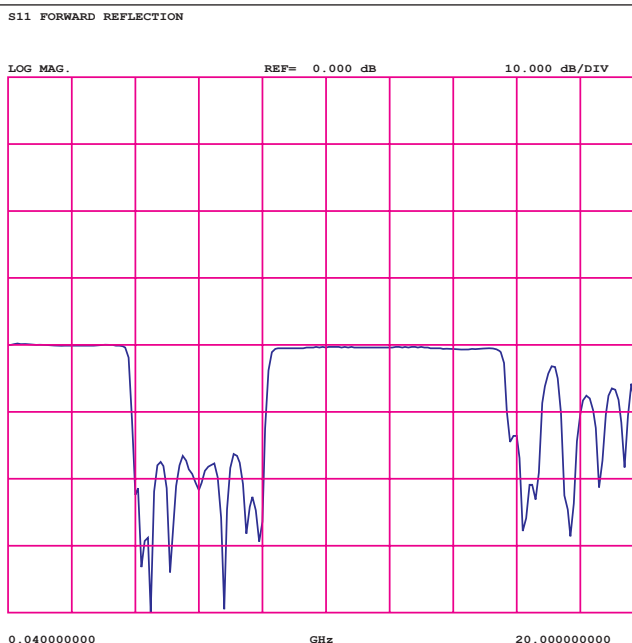
### 6-2 DISPLAY MODES AND TYPES

The 37XXXD displays measurement data using a “Channel Concept.” This means that each channel can display both a different S-Parameter and a different graph type. As you select each channel, the graph type, scaling, reference delay, S-Parameter, etc., associated with that channel appears on the screen. You can display the same S-Parameter on two or more channels.

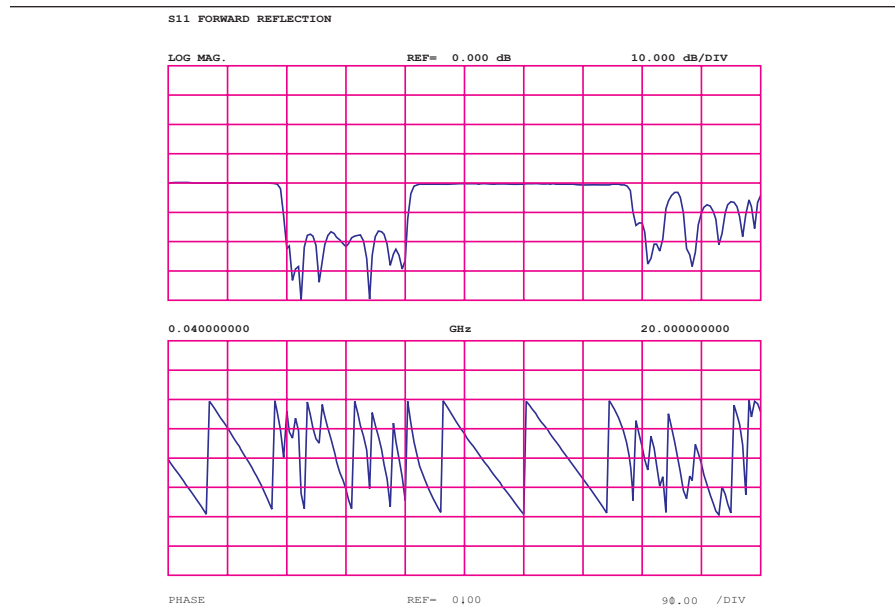
Several graph-types are possible: polar, rectilinear, or Smith chart. The rectilinear graph-type may be magnitude, phase, magnitude and phase, SWR, group delay, real, imaginary, and real and imaginary. The Smith chart graph-type is specifically designed to plot complex impedances.

#### *Single Channel Display: Ch 1, 2, 3, 4*

You select this display type (Figures 6-1 and 6-2) by choosing “Single Display” on Menu CM (Appendix A). Possible graph types are Smith, polar, rectilinear, or dual (split) rectilinear (magnitude and phase).



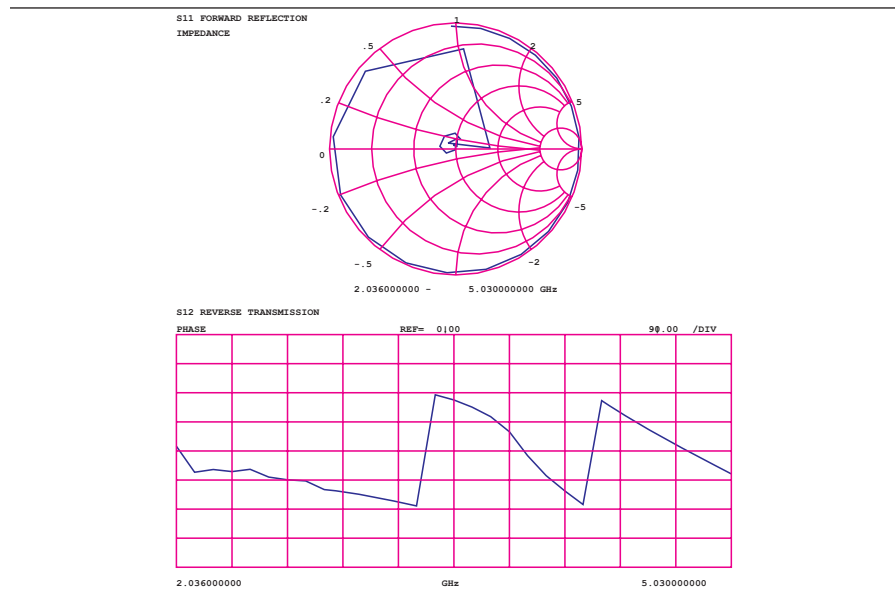
**Figure 6-1.** Single Channel Display, Log Magnitude



**Figure 6-2.** Single Channel Display, Magnitude and Phase

**Dual Channel Display:  
Ch 1 and 3 or Ch 2 and 4**

If you have chosen a dual display of magnitude and phase, the affected area of the LCD screen is subdivided into two smaller portions (Figure 6-3). You select this display type by choosing “Dual Display” in Menu CM (Appendix A).

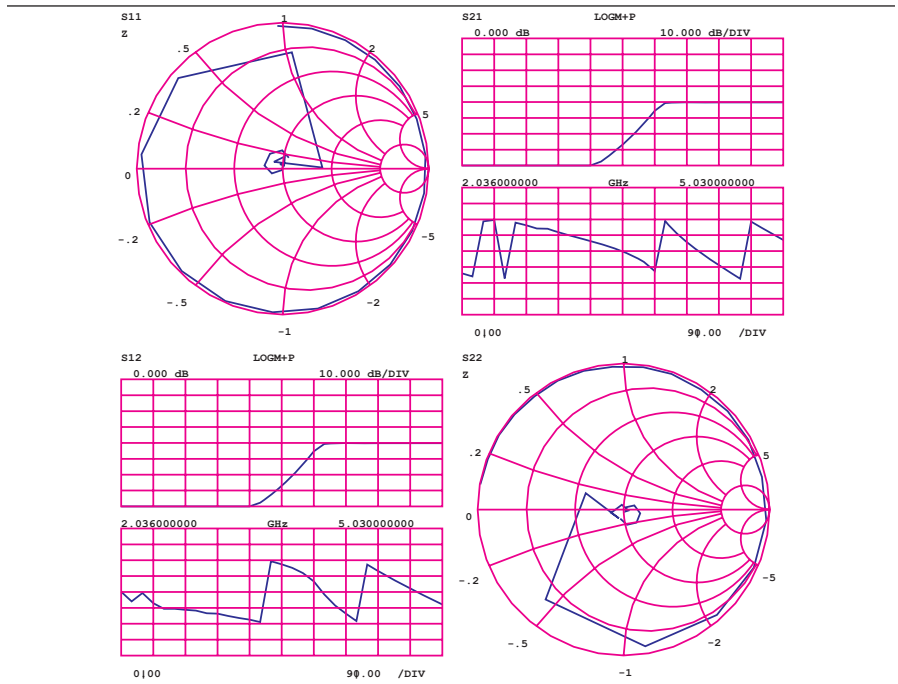


**Figure 6-3.** Dual Channel Display



**Four Channel Display:  
Ch 1, 2, 3, 4**

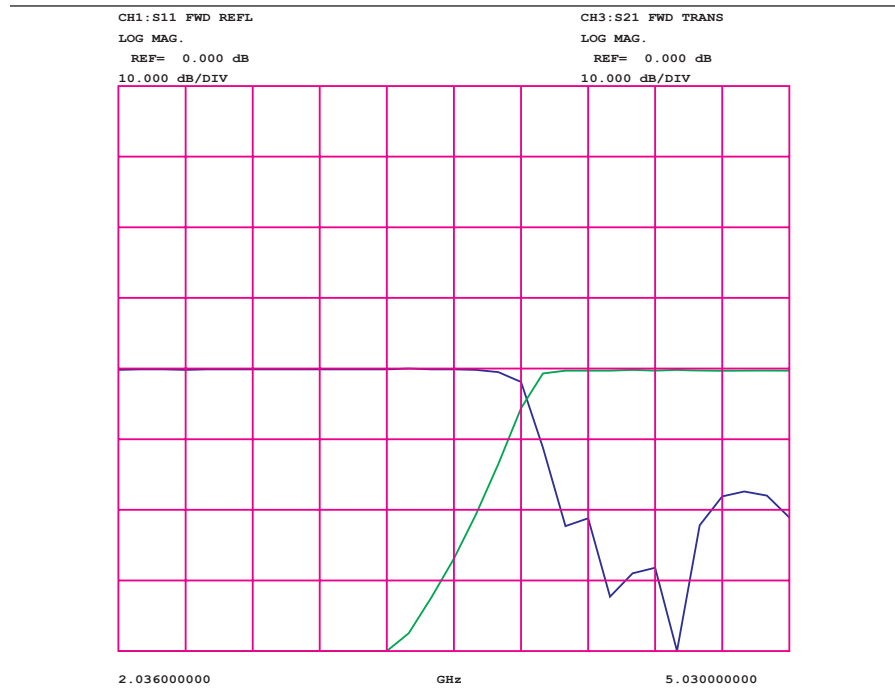
From four-to-eight graph types are displayed. In each quadrant, the graph type can be any of the possible choices listed in the GT menu (Appendix A). If you have chosen to display magnitude and phase on a channel, the quadrant displaying that channel is further subdivided as described above. You select this display type by choosing "All Four Channels" in Menu CM. An example of a four-channel display appears in Figure 6-4, below.



**Figure 6-4.** Four-Channel Display

**Dual Trace Overlay**

For rectilinear graph types, two traces can be displayed, one overlaid (superimposed) on the other (Figure 6-5). By menu selection, the two traces can be Channel 1 overlaid on Channel 3 or Channel 2 overlaid on Channel 4. Each trace is in a different color. Channels 1 and 2 are displayed in red, while Channels 3 and 4 are displayed in yellow.



**Figure 6-5.** Dual Trace Overlay

***Graph Data Types***

The data types (real, imaginary, magnitude, phase) used in the displayed graph-types reflect the possible ways in which S-Parameter data can be represented in polar, Smith, or rectilinear graphs. For example: Complex data—that is, data in which both phase and magnitude are graphed—may be represented and displayed in any of the ways described below:

- Complex Impedance—displayed on a Smith chart graph
- Real and imaginary—displayed on a real and imaginary graph
- Phase and magnitude components—displayed on a rectilinear (Cartesian) or polar graph
- Group delay plot—group-delay measurement units are time, those of the associated aperture are frequency and SWR

The quantity group delay is displayed using a modified rectilinear-magnitude format. In this format the vertical scale is in linear units of time (ps-ns- $\mu$ s). With one exception, the reference value and reference line functions operate the same as they do with a normal magnitude display. The exception is that they appear in units of time instead of magnitude.

Examples of graph-data types are shown in Figure 6-6 through 6-11, on the following pages.

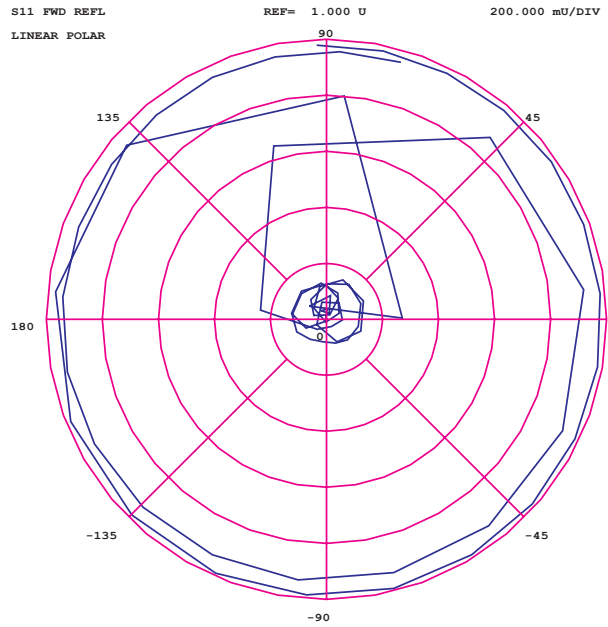


Figure 6-6. Linear Polar Graticule

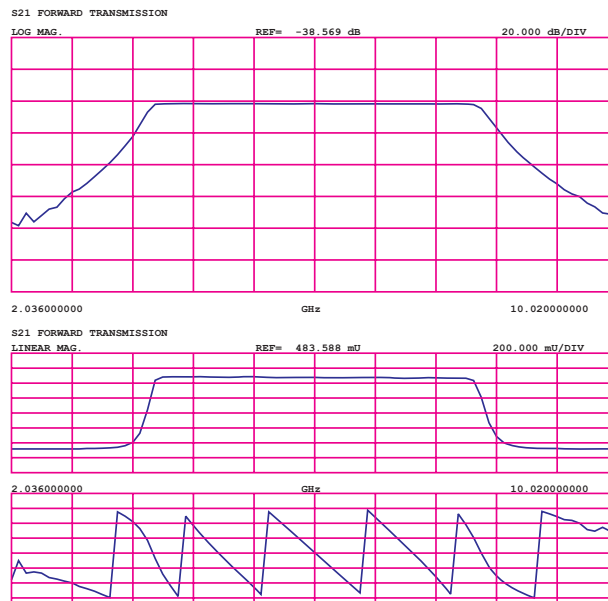


Figure 6-7. Dual Channel Rectilinear Graticule

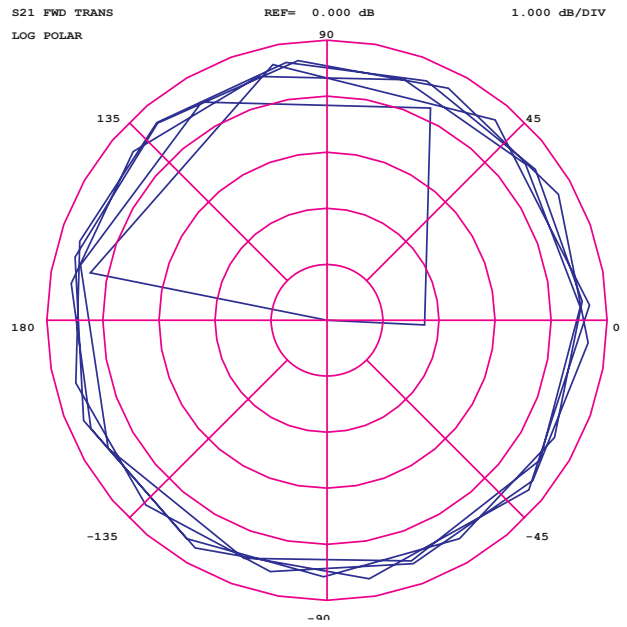


Figure 6-8. Log Polar Graticule

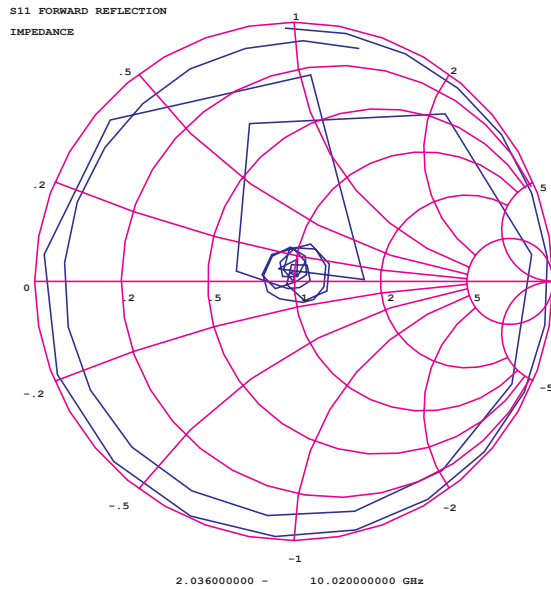


Figure 6-9. Normal Smith Chart

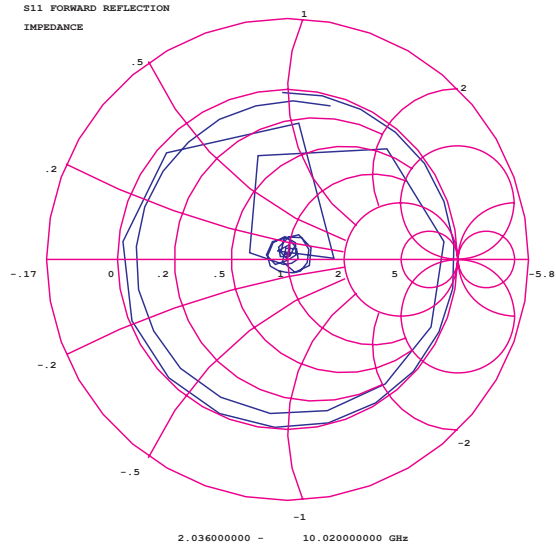


Figure 6-10. 3 dB Compressed Smith Chart

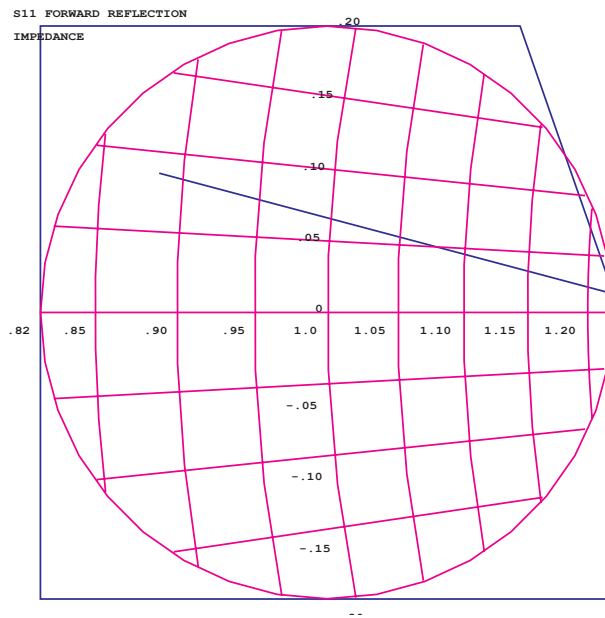
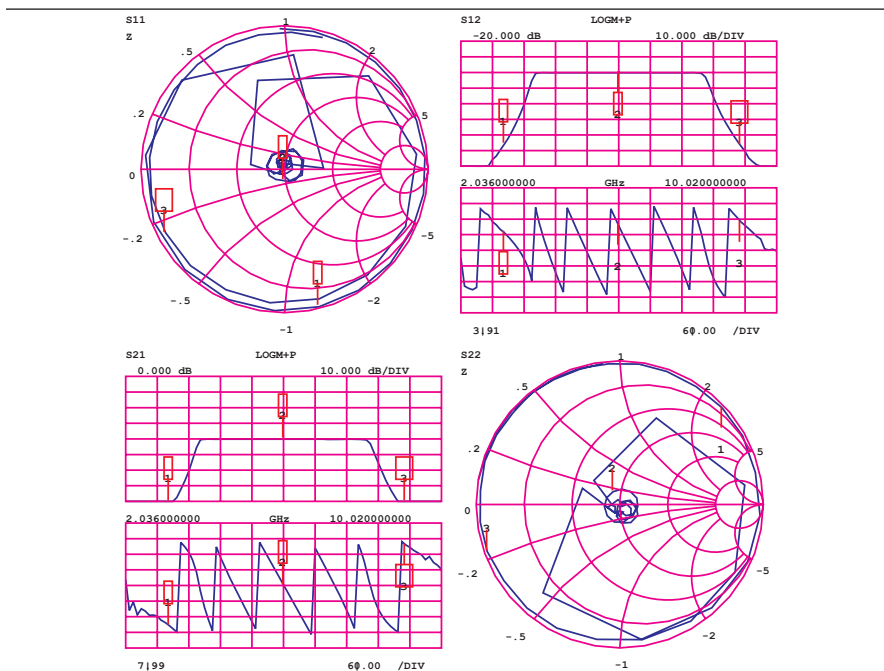


Figure 6-11. 20 dB Compressed Smith Chart

### 6-3 FREQUENCY MARKERS

The example below shows how the 37XXXD annotates markers for the different graph-types. Each marker is identified with its own number. When a marker reaches the top of its graticule, it will flip over and its number will appear below the symbol. When markers approach the same frequency, they will overlap. Their number will appear as close to the marker as possible without overlapping.



**Figure 6-12.** Marker Annotation

#### Marker Designation

Depending on menu selection, you may designate a marker as the “active” or the “delta reference” marker. If you choose a marker to be active—indicated by its number being enclosed in a square box—you may change its frequency or time (distance) (or point number in CW Draw) with the Data Entry keypad or knob. If you have chosen it to be the delta-reference marker, a delta symbol ( $\Delta$ ) appears one character space above the marker number (or one character space below a “flipped” marker). If the marker is both active and the delta reference marker, the number and the delta symbol appear above (below) the marker. The delta symbol appears above (below) the number.

### 6-4 LIMITS

Limit lines function as settable maximum and minimum indicators for the value of displayed data. These lines are settable in the basic units of the measurement on a channel-by-channel basis. If the display is rescaled, the limit line(s) will move automatically and thereby maintain their correct value(s).

Each channel has two limit lines (four for dual displays), each of which may take on any value. Limit lines are either horizontal lines in rectangular displays or concentric circles around the origin in Smith and polar displays.

Each channel can produce segmented limits. They allow different upper and lower limit values to be set at up to ten segments across the measurement range.

## **6-5 STATUS DISPLAY**

In addition to the graticules, data, markers, and marker annotation, the 37XXXD displays certain instrument status information in the data display area. This information is described below.

### ***Reference Position Marker***

The Reference Position Marker indicates the location of the reference value. It is displayed at the left edge of each rectangular graph-type. It consists of a green triangular symbol similar to the cursor displayed in the menu area. You can center this symbol on one of the vertical graticule divisions and move it up or down using the “Reference Position” option. When you do this, the data trace moves accordingly. If you also select the reference value option, the marker will remain stationary and the trace will move with the maximum allowable resolution. When changing from a full-screen display to half- or quarter-screen display, the marker will stay as close to the same position as possible.

### ***Scale Resolution***

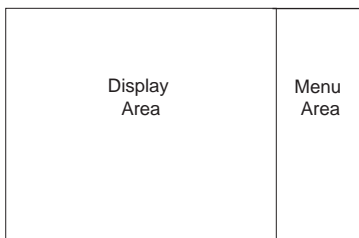
Each measurement display is annotated with the scale resolution. For log-magnitude displays resolution ranges from 0.001 to 50 dB per division. Linear displays of magnitude range from 0.001 to 50 units per division. Cartesian phase displays can range from 0.01 to 90 degrees per division. The polar display is 45 degrees per display graticule.

### ***Frequency Range***

Each measurement display is annotated with the frequency range of the measurement.

### ***Analog Instrument Status***

The 37XXXD displays analog-instrument-status messages (in red when appropriate) in the upper right corner of the data-display area (left). They appear at the same vertical position as line 2 of the menu area. If more than one message appears, they stack up below that line.



*Display screen  
showing the data*



**Measurement Status**

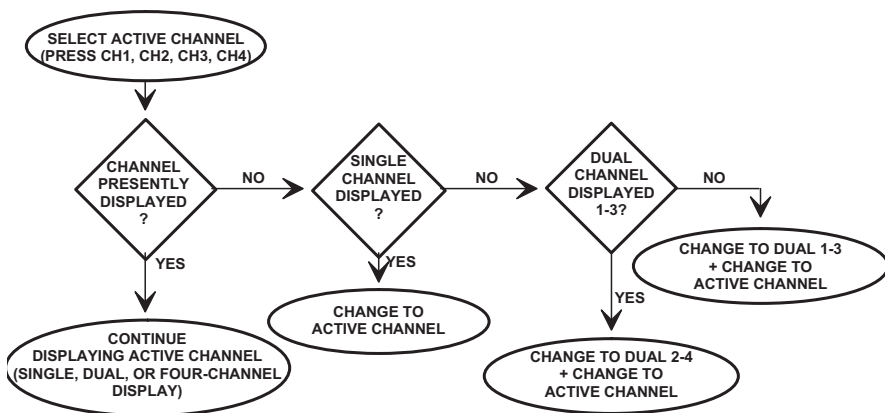
The 37XXXD displays measurement-status messages (in red when appropriate) in the upper-right corner of the graticule (channel) to which they apply.

**Sweep Indicator Marker**

A blue sweep-indicator marker appears at the bottom of each displayed graph-type. It indicates the progress of the current sweep. When measuring quiet data—that is, data having few or no perturbations—this indicator assures that the instrument is indeed sweeping. Its position is proportional to the number of data points measured in the current sweep. If the sweep should stop for any reason, the position of the indicator will stop changing until the sweep resumes.

**6-6 DATA DISPLAY CONTROL**

The following figure shows the algorithm that the 37XXXD uses to display the active channel.



**Figure 6-13.** Active Channel Algorithm

***S-parameter Selection***

If you select a new S-parameter using Menu SP (Appendix A), it appears on the then-active channel in the same graph-type in which it was last displayed. The following table shows the displayable S-parameters based on the correction type you have in place. If you attempt to display other S-parameters, an error message appears. In cases when there is no last-displayed S-parameter stored, the display will default as shown. If an S-parameter is selected for which there was no last-displayed graph-type, the display defaults to S<sub>21</sub>, S<sub>12</sub> Log Magnitude and Phase and S<sub>11</sub>, S<sub>22</sub> Smith.

***Data Display Update***

When you change a control panel parameter that affects the appearance of the display, the entire display changes immediately to reflect that change. For example, if you press Autoscale, the entire display rescales immediately. You do not have to wait for the next sweep to see the results of the change. The following parameters are supported for this feature: Reference Delay, Offset, Scaling, Auto Scale, Auto Reference Delay, Trace Math, IF BW, and Smoothing. In the case of Averaging, the sweep restarts.

Correction Type	Displayable S-parameters	Default Display Position			
		CH1	CH2	CH3	CH4
<i>None</i>	All	S11	S12	S21	S22
<i>Frequency Response</i>					
Reverse Transmission	S12		S12		
Forward Transmission	S21			S21	
Both	S12, S21		S12	S21	
<i>Port 1 Reflection Only</i>	S11	S11			
<i>Port 2 Reflection Only</i>	S22				S22
<i>Reflection Only, Both</i>	S11, S22	S11			S22
<i>Forward 1-Path 2-Port</i>	S11, S21	S11		S21	
<i>Reverse 1-Path 2-Port</i>	S12, S22		S12		S22
<i>12-Term</i>	All	S11	S12	S21	S22

If the knob is used to vary any of the above parameters, the change occurs as the measurement progresses—that is, the continuing trace will reflect the new setting(s).

When you change a marker frequency or time (distance), the readout parameters will change. This change reflects the changes in measurement data at the marker’s new frequency, using data stored from the previous sweep.

***Display of Markers***

Once you have selected a marker to display, it will appear on the screen. It does not matter what resolution you have selected. When you set a marker to another calibrated frequency and then lower the

resolution, that frequency and the marker will continue to display. It will display even if its frequency is not consistent with the data points in the lower-resolution sweep.

## **6-7** HARD COPY AND DISK OUTPUT

In addition to the LCD screen, the Model 37XXXD is capable of outputting measured data as a:

- Tabular Printout
- Screen-Image Printout
- Pen Plot
- Disk Image of the Tabular Data Values

The selection and initiation of this output is controlled by the Hard Copy keys.

### ***Tabular Printout***

An example of a tabular format is shown in Figure 6-14 (page 6-16). The tabular formats are used as follows:

- Tabular Printout Format*: Used when printing three or four channels.
- Alternate Data Format*: Used when printing one or two channels.

In tabular printouts, the 37XXXD shifts the data columns to the left when an S-Parameter is omitted. Leading zeroes are always suppressed. The heading (Model, Device ID, Date, Operator, Page) appears on each page.

### ***Screen-Image Printout***

In a Screen-Image Printout, the exact data displayed on the screen is dumped to the printer. The dump is in the graphics mode, on a pixel-by-pixel basis.

### ***Plotter Output***

The protocol used to control plotters is "HP-GL (Hewlett-Packard Graphics Language). HP-GL contains a comprehensive set of vector graphics type commands. These commands are explained in the Interfacing and Programming Manual for any current model Hewlett-Packard plotter, such as the 7470A.

When the plotter is selected as the output device, it is capable of drawing the graph shown on the screen or of drawing only the data trace(s). Multiple traces may be drawn on a single sheet of paper (in different colors, if needed).

### ***Disk Output***

The 37XXXD can write-to or read-from the disk all measured data. This data is stored as an ASCII file in the exact same format as that shown for the tabular printout in Figure 6-14 (page 6-16). If read back from the disk, the data is output to the printer. There, it prints as tabular data.

37247A

MODEL:  
DEVICE ID:

DATE:  
OPERATOR:

SWEEP DATA

START: 0.040000000 GHz GATE START: -  
STOP: 20.000000000 GHz GATE STOP: -  
STEP: 0.099800000 GHz GATE: -  
WINDOW: -

-----CH1-----  
PARAMETER: -S11-  
NORMALIZATION: OFF  
REFERENCE PLANE: 0.0000 mm  
SMOOTHING: 0.0 PERCENT  
DELAY APERTURE: -

MARKERS:

MKR #	FREQ GHz	MAGNITUDE dB
-------	----------	--------------

FREQUENCY POINTS:

PNT #	FREQ GHz	MAGNITUDE dB
1	0.040000000	-54.881
2	0.139800000	-60.875
3	0.239600000	-59.163
4	0.339400000	-55.751
5	0.439200000	-53.856
6	0.539000000	-53.139
7	0.638800000	-51.019
8	0.738600000	-49.457
9	0.838400000	-48.807
10	0.938200000	-48.195

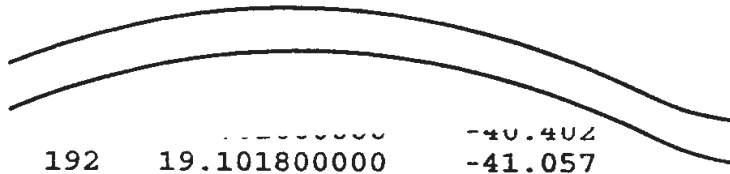


Figure 6-14. Example of a Tabular Printout

# **Chapter 7**

## **Measurement Calibration**

### **Table of Contents**

---

7-1	INTRODUCTION . . . . .	7-3
7-2	DISCUSSION . . . . .	7-3
	Establishing the Test Ports . . . . .	7-3
	Understanding the Calibration System . . . . .	7-5
	Calibrating for a Measurement . . . . .	7-9
	Evaluating the Calibration . . . . .	7-11
	Verification Kits . . . . .	7-11
7-3	SLIDING TERMINATION . . . . .	7-13
7-4	SOLT CALIBRATION . . . . .	7-19
7-5	OFFSET-SHORT CALIBRATION (SSLT) . . . . .	7-28
7-6	TRIPLE OFFSET-SHORT CALIBRATION (SSST) . . . . .	7-32
7-7	LRL/LRM CALIBRATION . . . . .	7-36
7-8	TRM CALIBRATION . . . . .	7-46
7-9	MERGE CAL FILES APPLICATION . . . . .	7-47



# Chapter 7

## Measurement Calibration

### 7-1 INTRODUCTION

This section provides discussion and examples for performing a measurement calibration. It also provides a detailed procedure for calibrating with a sliding termination.

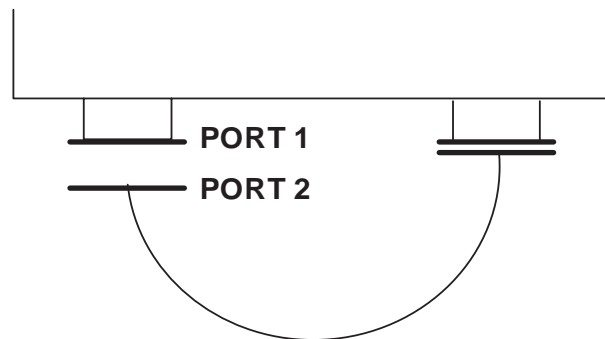
### 7-2 DISCUSSION

Measurements always include a degree of uncertainty due to imperfections in the measurement system. The measured value is always a combination of the actual value plus the systematic measurement errors. Calibration, as it applies to network analysis, characterizes the systematic measurement errors and subtracts them from the measured value to obtain the actual value.

The calibration process requires that you establish the test ports, perform the calibration, and confirm its quality. Let us examine each of these steps.

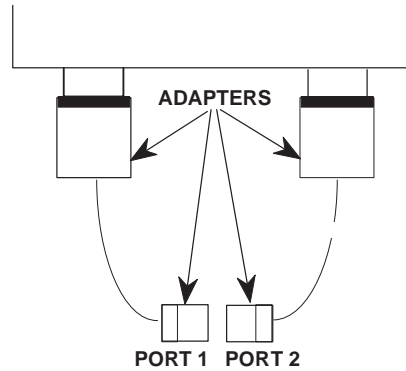
#### *Establishing the Test Ports*

Figures 7-1 and 7-2 are two of the most common approaches used to make measurements on two-port devices. In many cases, you may need adapters to change between connector types (N, SMA, GPC-7, etc.) or between genders (male [M] or female [F]).



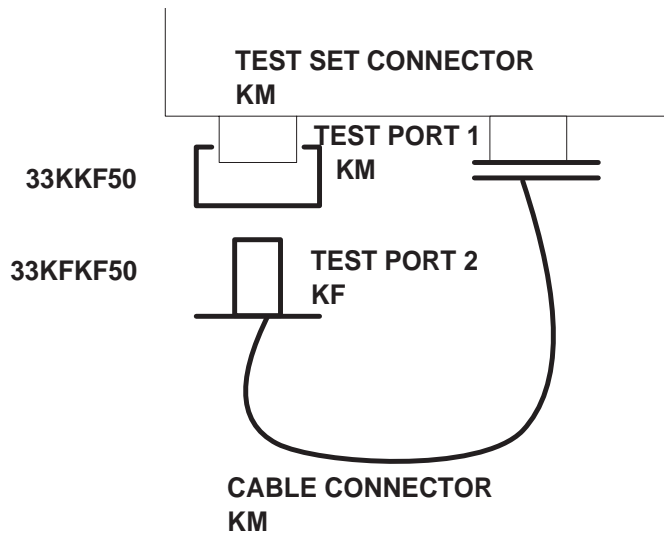
**Figure 7-1.** *Establishing the Test Port*

The use of cables and/or adapters does not effect the final measurement result, if they were in place for the calibration process. The vector error corrections established during the calibration process eliminates cable and/or adapter effects as long as the ports used are stable and exhibit good repeatability. Figure 7-2 shows such a configuration.



**Figure 7-2.** Using Adapters on the Test Port

Many calibration kits include adapters that are designed to have equal phase length. These parts are called phase equal adapters (PEA). Anritsu designs in-series adapters (e.g., K Connector M-M, M-F, F-F) to be phase insertable when technically possible. When available, it is good practice to use PEAs to establish test ports (Figure 7-3).



**Figure 7-3.** Use of PEAs to Establish Test Ports



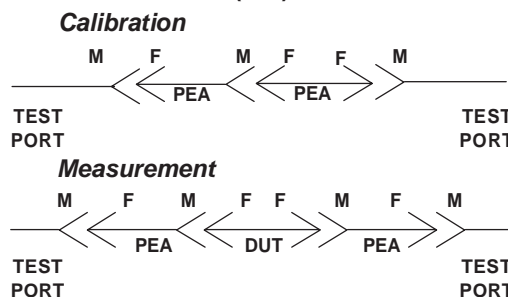
This approach offers two advantages:

- ❑ It minimizes wear on the more expensive test set and cable connectors
- ❑ It provides a simple solution to measuring non-insertable devices (e.g., a filter with K female input and output connectors) by merely swapping PEAs after calibration. See Figure 7-4

**NOTE**

In this and other discussions, we will talk about “insertable” and “non-insertable” devices. Insertable devices have an insertable connector pair (i.e., male input and female output connectors) and can be measured after a through calibration. A non-insertable device has a non-insertable pair of connectors. This would be the case if it included female connectors on both ports or different connector types on each port. Therefore, “non-insertables” cannot be connected directly into the measurement path without an adapter.

**USING THE PHASE-EQUAL INSERTABLE (PEI)**



**Figure 7-4.** Using Phase-Equal Insertables

**Understanding the Calibration System**

Measurement errors must be reduced by a process that uses calibration standards. The standards most commonly used are Opens, Shorts, and  $Z_0$  (Characteristic Impedance) Loads. In conjunction with a through connection, these standards can correct for the major errors in a microwave test system. These errors are Directivity, Source Match, Load Match, Isolation, and Frequency Tracking (reflection and transmission).

Calibration also corrects for many internal system errors, such as RF leakage, IF leakage, and system component interaction.

Random errors such as noise, temperature, connector repeatability, DUT sensitive leakages, frequency repeatability, and calibration variables are not completely correctable. However, some of them can be minimized by careful control. For instance: temperature effects can be reduced by room temperature control, calibration variables can be re-

**ERRORS REDUCED BY CALIBRATION**

- Directivity
- Source Match
- Load Match
- Frequency Sensitivity (Tracking)
- Isolation

**INTERNAL SYSTEM ERRORS**

- RF Leakage
- IF Leakage
- System Interaction

**RANDOM ERRORS**

- Frequency
- Repeatability
- Noise
- Connector Repeatability
- Temperature/Environmental Changes
- Calibration Variables

**TRANSMISSION MEASUREMENT ERRORS**

- Source Match
- Load Match
- Tracking

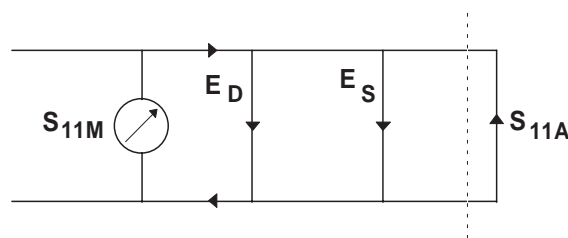
duced through improved technique and training, and frequency errors can be virtually eliminated by the fully synthesized internal source.

We know that adapters and cables degrade the basic directivity of the system, but these errors are compensated by vector error correction.

In general, transmission measurement errors are source match, load match, and tracking; while reflection measurement errors are source match, directivity, and tracking.

Error modeling and flow graphs are techniques used to analyze the errors in a system. Error models describe the errors, while flow graphs show how these errors influence the system. Error models (Figure 7-5) can become quite complex.

**DIRECTIVITY, SOURCE MATCH,  
AND TRACKING ERRORS  
DISTORTED MEASUREMENT**



**Figure 7-5.** Example of Error Modeling

The 37XXXD offers a selection of calibration possibilities depending on the user's needs. These possibilities are as follows:

- Frequency Response
- Reflection Only—1 Port
- 1 Path, 2 Port
- 12-Term—2 Port, Both Directions

These calibration types are described below.

**Frequency Response:** Corrects for one or both of the transmission error terms associated with measurements of  $S_{21}$ ,  $S_{12}$ , or both.

---

**REFLECTION MEASUREMENT ERRORS**

- Source Match
  - Directivity
  - Tracking
- 

**Reflection Only:** Corrects for the three error terms associated with an S11 measurement (EDF, ESF, and ERF), an S22 measurement (EDR, ESR, and ERR), or both.

**1 Path, 2 Port:** Corrects for the four forward-direction error terms (EDF, ESF, ERF, and ETF), or the four reverse-direction error terms (EDR, ESR, ERR, and ETR).

**Full 12-Term:** Corrects for all twelve error terms associated with a two-port measurement. A 12-Term error model is shown in Figure 7-6.

Measurement calibration using the 37XXXD is straightforward and menu directed. A short time spent in preparation and preplanning will make the process simple and routine. (Example: Adjusting the coaxial cables used in the measurement setup such that insertion of the DUT causes minimal flexing of these cables).

---

**CALIBRATION TYPES**

- Frequency Response
  - Reflection Only—1 Port
  - 1 Path, 2 Port
  - 12 Term—2 Port, Both Directions
- 

The screen prompts on the 37XXXD guide you through the calibration process—a process that consists of connecting and disconnecting connectors and moving the slide on a sliding load (if one is used).

The most critical part of the calibration process is properly seating and torquing the connectors. Also, you will notice that the calibration takes longer when the ports are terminated with a load. This is intentional. It allows for more averaging during the isolation measurement.

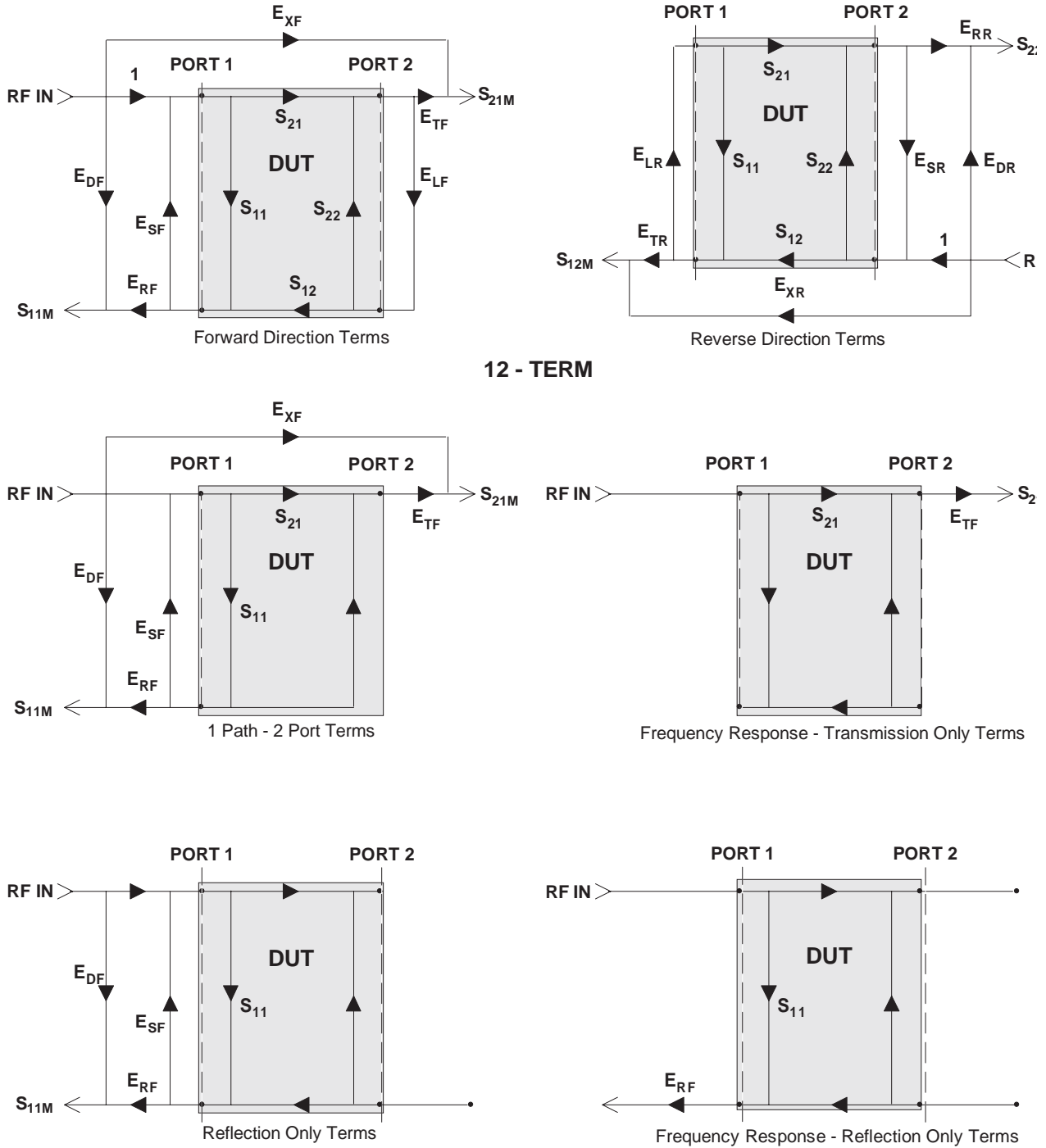


Figure 7-6. Error Models

***Calibrating for a Measurement***

---

**CALIBRATING FOR A REFLECTION MEASUREMENT USES THREE STANDARDS:**

- Short
- Open
- Termination

---

**IDEAL TERMINATIONS**

- Reflectionless
- Perfect Connector
- Infinite-Length, Dimensionally Exact, Reflectionless Transmission Line

---

**PRACTICAL  $Z_0$  TERMINATIONS**

- Broadband Load
  - Sliding Termination
- 

Let us assume that we want to correct for three errors in the reflection measurement: source match, directivity, and tracking. We accomplish this using three standards.

Shorts are the easiest to visualize. They totally reflect all of the incident RF energy output at a precise phase. The terms zero-ohms impedance, voltage null, and 180° phase all define an RF Short.

Opens are similar to Shorts, but their response is more complex. The terms voltage maximum, infinite impedance, and 0° phase all define a perfect Open. A perfect Open, however, is only a concept. In reality Opens always have a small fringing capacitance.

To account for the fact that the Open will not predictably reflect impedance at an exact 0° phase reference, we alter its response using coefficients that accurately characterize the fringing capacitance. The coefficients are different for each coaxial line size, since each size has a different fringing capacitance. To maximize accuracy, ensure that these coefficients are installed prior to the calibration (Menu U3).

As Opens and Shorts provide two references for a full reflection,  $Z_0$  terminations provide a zero-reflection reference.

Ideal  $Z_0$  terminations must consist of two parts, a perfect connector and an infinite-length perfect transmission line that absorbs all of the RF energy that enters it (no reflections).

Infinite length transmission lines are unwieldy at best, so you must use less-than-ideal terminations. For calibration purposes there are two common types: broadband loads and sliding terminations.

---

**BROADBAND LOAD**

- Easy to Use
  - Inexpensive
  - Adequate for Most Applications
- 

---

**SLIDING LOAD**

- Connector
  - Long Transmission Line
  - Movable Microwave Load
- 

Broadband loads are widely used. An example is the Anritsu 28 Series Termination. These terminations are easy to use as calibration tools, and they are adequate for most applications.

Sliding Loads are the traditional vector network analyzer  $Z_0$  calibration reference. They provide the best performance when the application requires high-precision return loss measurements. Sliding loads consist of a connector, a long section of precision transmission line, and a microwave load that is movable within the transmission line. One thing to remember with sliding loads is that they have a low-frequency limit and must be used with a fixed load below this cutoff frequency for full frequency coverage. Anritsu sliding loads cut off at 2 GHz. (V-connector sliding loads cut off at 4 GHz).

Pin depth—the relationship between the interface positions of the outer and center conductors—is the most critical parameter under your control in a sliding load. An example of its criticality is that an incorrect pin depth of 0.001 inch can cause a reflection return loss of 44 dB. And, since we are trying to calibrate to accurately measure a 40 dB return loss, correct pin depth makes a big difference!

Cables in the measurement system are another cause for concern. The main criteria for a cable are stability and repeatability. Anritsu offers two types of cables that meet these criteria: semi-rigid and flexible. Our semi-rigid cables provide maximum stability with limited flexibility of movement. Our flexible cables allow more freedom of movement and provide good phase stability.

***Evaluating the Calibration***

The 37XXXD provides an accurate representation of complex data. However, it can only provide accuracy to the extent of the supplied calibration data. For this reason, it is necessary to periodically verify the calibration data and the 37XXXD system performance.

Calibration verification reveals problems such as a poor contact with one of the calibration components, improper torquing, or a test port out of specification. Problems like these can easily occur during a calibration procedure. Anyone who has experienced one of these problems and stored bad data—after having performed a complete calibration procedure—knows the frustration it can cause. Additionally, it can be very costly to use incorrectly taken measurement data for design or quality assurance purposes.

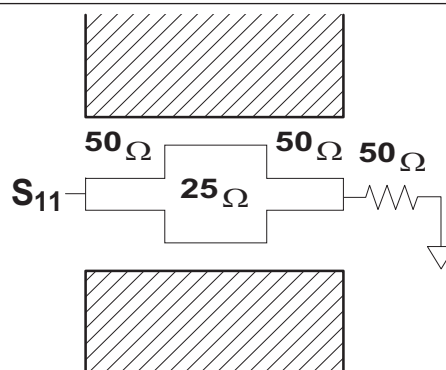
The best way to confirm a calibration is to measure a precision, known-good device and confirm its specifications.

***Verification Kits***

Anritsu has developed several precision-component kits: for 3.5 mm connectors, for GPC-7 connectors, K Connectors® and V Connectors®. These are, respectively, the Models 3666, 3667, and 3668 and 3669 Verification Kits.

Each of the kits contain 20 dB and 50 dB attenuators, an airline, and a Beatty Standard. A Beatty Standard is a two-port mismatch similar to a beadless airline. It consists of a center conductor with a discontinuity in the middle providing the mismatch (Figure 7-7).

Typically, these verification kits will be used by calibration or metrology labs. Each of the kits contain several precision components, all of which have been characterized at specified frequencies. The data on these components is stored on a disk provided with the verification kit.



**Figure 7-7.** The Beatty Standard

The verification of the kit components is straight forward. The components are first measured with the 37XXXD, then they are compared with the data recorded on the disk. If the measured data compares favorably with the recorded data (taking tolerances into consideration), then the system is known to be operating properly and providing accurate data.

There is one caution that you need to observe when using Verification Kits. Because the verification components have been characterized, you must handle them carefully so that you do not change their known characteristics. Consequently, you should not have them available for daily use. Rather, you should only use them for the accuracy verification checks taken every 6-to-12 months (or at any other time the system's integrity is in doubt).

This completes the discussion on calibration. Refer to paragraph 7-3 for a procedure showing how to calibrate the sliding load.



### 7-3 SLIDING TERMINATION

Sliding terminations (loads) are the traditional  $Z_0$  calibration-reference devices for vector network analyzer calibration. When correctly used and perfectly aligned, they can be more accurate than precision fixed loads. However, sliding terminations have a 2 GHz (4 GHz for V-Connector sliding loads) low-frequency limit and must be used with a fixed load for full frequency-range coverage.

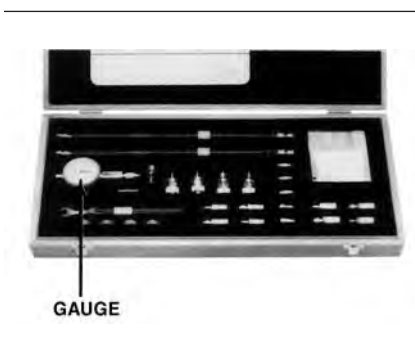
Sliding terminations consist of a connector, a long section of precision transmission line, and a microwave load that is movable within the transmission line. Pin depth—the relationship between the interface positions of the outer and center conductors—is the most critical parameter that you can control in a sliding termination. An example of its criticality is that an incorrect pin depth of 0.001 inch can cause a reflection return loss of 44 dB. Since you are usually calibrating to accurately measure a greater than 40 dB return loss, correct pin depth is essential.

Since setting an accurate pin depth is so important, this discussion centers on describing how to set the pin depth for male and female sliding terminations. Calibration with the sliding termination is essentially the same as described below for the broadband load.

The procedure below uses the Model 3652 Calibration Kit and its 17KF50 and 17K50 Sliding Terminations. Calibration is similar for the Model 3650 SMA/3.5mm, Model 3651 GPC-7 and Model 3654 V connector kits. For the 3651, the procedure is simpler because the GPC-7 connector is genderless, there are no male and female versions.

#### Procedure

- Step 1.** Remove the Pin Depth Gauge from the kit, place it on the bench top.



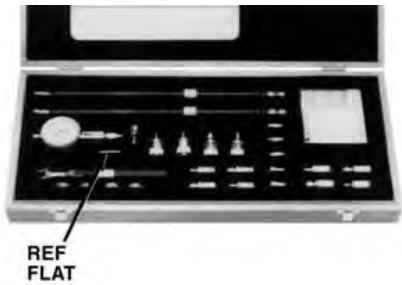
#### NOTE

The gauge is convertible between male and female. The following procedure describes the zeroing process for the female fitting. The procedure for the male fitting begins with Step 16.



**Step 2.**

Push the outer locking ring towards the gauge to expose the center pin.



**Step 3.**

Take the 01-210 Ref Flat from the kit.



**Step 4.**

While holding the gauge as shown, press the Ref Flat firmly against the end of the exposed center pin.

**Step 5.**

While pressing the Ref Flat against the center pin, check that the pointer aligns with the “0” mark. If it does not, loosen the bezel lockscrew and rotate the bezel to align the pointer with the “0” mark. Tighten the bezel lock screw.

**NOTE**

Gently rock the Ref Flat against the center pin to ensure that it is fully depressed and you have accurately set the gauge for zero.

**Step 6.**

Remove the sliding termination with the female-connector (17KF50, for this example) from the kit, and slide the load all the way toward the end closest to the connector.

**Step 7.**

With either hand, pick up the sliding termination near its connector end.

**Step 8.**

Cup the sliding termination in your palm, and support the barrel between your body and crooked elbow.

**Step 9.**

Remove the flush short by holding its body and unscrewing its connector.

**Step 10.**

Install the gauge onto the end of the sliding termination.

**Step 11.**

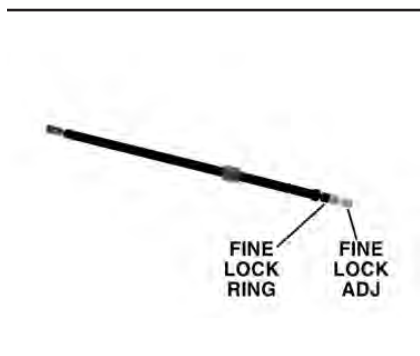
If the COARSE SET adjustment—which has been set at the factory—has not moved, the inner dial on the gauge will read “0.” If it doesn’t, perform the Coarse Set Adjustment in Step 15.

**Step 12.**

Place the sliding termination, with the gauge attached, on the bench top.

**Step 13.**

Loosen the FINE LOCK ring and turn the FINE ADJ ring to position the gauge pointer 2-3 small divisions on the “-” side of zero.



**Step 14.**

Turn the FINE LOCK ring clockwise to both tighten the adjustment and place the pointer exactly to “0.” The Sliding Termination is now ready to use.

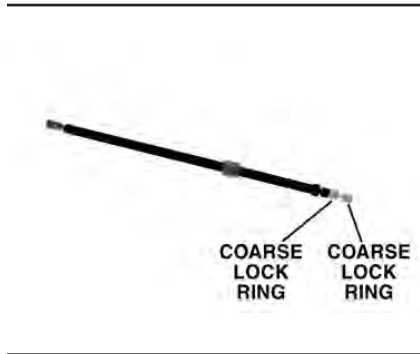


**NOTES**

Ensure that the inner dial reads “0.”  
The following step is not normally necessary. It needs to be done only if the adjustment has changed since it was set at the factory.

**Step 15.**

With the 01-211 Flush Short installed, loosen the COARSE LOCK and gently push the COARSE SET adjustment rod in as far as it will go. This coarsely sets the center conductor to be flush against the attached short. Return to Step 2.

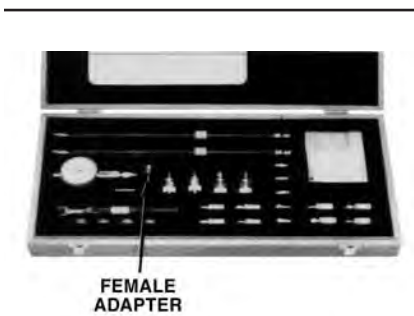


**Step 16.**

The procedure for adjusting the male-connector sliding termination is essentially the same as that described above. The only difference is that you must install the female adapter on the end of the gauge shaft, over the center conductor. To install this adapter, proceed as follows:



- Zero-set the gauge as described in Steps 2 through 5.
- Push the outer locking ring back toward the gauge and turn it clockwise onto the exposed threads.
- Loosen the lock ring one turn in a counterclockwise direction.

**Step 17.**

Remove the 01-223 Female Adapter ("F ADAPTER FOR PIN GAUGE") from the kit.

**Step 18.**

Install the female adapter over the center pin and screw it into the locking ring, and tighten the outer ring until it is snug against the housing.

**Step 19.**

Inspect the end of the adapter, you should see no more than two exposed threads. If so, repeat Steps 7 through 10.

**Step 20.**

Connect the gauge to the sliding termination and zero set the center pin using the FINE ADJ as previously described in Steps 2 through 5.

---

**7-4 SOLT CALIBRATION**

The SOLT calibration for the 37XXXD Vector Network Analyzer system uses a Short, Open, Load, and a Thru line connection to categorize the inherent errors in the measurement system. These errors include those caused by connectors as well as internal system errors such as RF leakage, IF leakage, and component interaction. For maximum accuracy, install the capacitive coefficients (for the open device) using Menu U3.

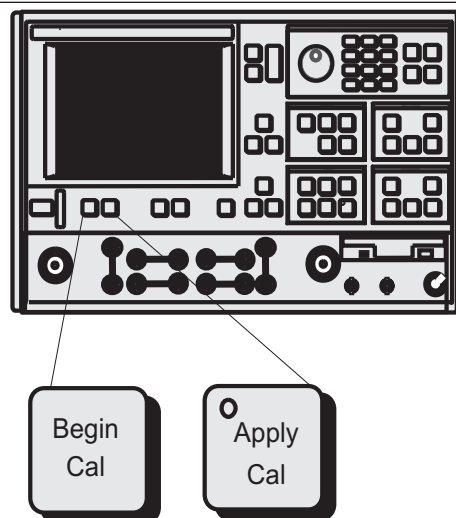
**NOTE**

The SOLT calibration, in conjunction with the SSST calibration, are merged to create a continuous, single sweep broadband calibration on the ME7808C system. Refer to Chapter 15 for details about the broadband mode of operation.

**Calibration Procedure**

A detailed, step-by-step procedure for performing a Short-Open-Load-Throughline calibration is given below.

**Step 1.** Press the Begin Cal key.



MENU C11
BEGIN CALIBRATION
KEEP EXISTING CAL DATA
REPEAT PREVIOUS CAL
AUTOCAL
CAL METHOD STANDARD
TRANSMISSION LINE TYPE: XXXXXXXX
CHANGE CAL METHOD AND LINE TYPE
NEXT CAL STEP
PRESS <ENTER> TO SELECT

**Step 2.** Select **CHANGE CAL METHOD AND LINE TYPE**, in menu C11 (left). (This assumes SOLT and COAXIAL are not presently shown in blue as being selected.)

MENU C11A
CHANGE CAL METHOD AND LINE TYPE
NEXT CAL STEP
CAL METHOD
SOLT (STANDARD)
SSLT (DOUBLE OFFSET SHORT WITH LOAD)
SSST (TRIPLE OFFSET SHORT)
LRL/LRM
TRM
TRANSMISSION LINE TYPE
COAXIAL
WAVE GUIDE
MICROSTRIP
PRESS <ENTER> TO SELECT

**Step 3.**

When menu C11A (left) appears, move the cursor to the following:

- a. **SOLT (STANDARD)**, then press the Enter key. This selects Standard (SOLT) as the calibration method.
- b. **COAXIAL**, then press the Enter key. This selects coaxial transmission line media.
- c. **NEXT CAL STEP**, then press the Enter key. This causes menu C11 to return to the screen.

**Step 4.**

When menu C11 reappears, confirm that the **SOLT** calibration method and **COAXIAL** line type have been selected. Select **NEXT CAL STEP** and press the Enter key to proceed. This brings up menu C5.

**Step 5.**

Menu C5 (left) lets you select the type of calibration. For this example, move the cursor to **FULL 12-TERM** and press the Enter key. This selection calibrates for all twelve error terms.

**Step 6.**

The next menu, C5D, lets you choose whether to include or exclude the error terms associated with leakage between measurement channels. For a normal calibration, you would choose to include these error terms. Therefore, move the cursor to **INCLUDE ISOLATION ( STANDARD )** and press the Enter key.

MENU C5
CALIBRATION TYPE
FULL 12-TERM
1 PATH
2 PORT
TRANSMISSION FREQUENCY RESPONSE
REFLECTION ONLY
PRESS <ENTER> TO SELECT

MENU C5D
SELECT USE OF ISOLATION IN CALIBRATION
INCLUDE ISOLATION (STANDARD)
EXCLUDE ISOLATION
PRESS <ENTER> TO SELECT



MENU C1
SELECT CALIBRATION DATA POINTS
<b>NORMAL</b> (1601 POINTS MAXIMUM)
C.W. (1 POINT)
N-DISCRETE FREQUENCIES (2 TO 1601 POINTS)
TIME DOMAIN (HARMONIC)
PRESS <ENTER> TO SELECT

**Step 7.**

Next, menu C1 appears. It lets you select the number of frequency points at which calibration data is to be taken. The choices are:

- a. **NORMAL:** Data is taken at up to 1601 equally spaced frequencies across the calibration frequency range. *Use this selection for this example.*
- b. **C.W.:** Data is taken at one point. This choice brings up menu C2B (below) that lets you select the single CW frequency point.

MENU C2B
SINGLE POINT CALIBRATION
C.W. FREQ XX.XXXX GHz
FINISHED ENTRY, NEXT CAL STEP
INPUT FREQ AND PRESS <ENTER> TO SELECT

MENU C2
FREQ RANGE OF CALIBRATION
<b>START</b> 0.0400000000GHz
<b>STOP</b> 20.000000000 GHz
201 DATA PTS 0.099800000 GHz STEP SIZE
MAXIMUM NUMBER OF DATA POINTS
1601 MAX PTS
801 MAX PTS
401 MAX PTS
<b>201 MAX PTS</b>
101 MAX PTS
51 MAX PTS
<b>NEXT CAL STEP</b>
PRESS <ENTER> TO SELECT

**Step 8.**

The next menu, C2 (left), lets you set your start and stop frequencies. For this example, move the cursor to **START**, press 40 on the keypad, and hit the MHz terminator key. Perform like operations for the **STOP** choice, except make entry read 20 GHz. After setting the frequencies, select **NEXT CAL STEP** and press the Enter key.

- c. **N-DISCRETE FREQUENCIES:** This selection lets you specify a discrete number of frequency points, from 2 to 1601.
- d. **TIME DOMAIN:** This selection is the calibration mode for low-pass time-domain processing. It lets you select frequencies at integer (harmonic) multiples of the start frequency.

MENU C3
CONFIRM CALIBRATION PARAMETERS
PORT 1 CONN K CONN (M)
PORT 2 CONN SMA (M)
REFLECTION PAIRING MIXED
LOAD TYPE SLIDING
THROUGHLINE PARAMETERS
REFERENCE IMPEDANCE
TEST SIGNALS
START CAL
PRESS <ENTER> TO SELECT OR CHANGE

**Step 9.**

When menu C3 (left) appears, if you want to change any of the parameters shown in blue letters, place the cursor on that parameter and press the Enter key. For this example, we will change them all, starting with the top one. Move the cursor to **PORT 1 CONN** and press the Enter key.

**Step 10.**

In menu C4 (below), which appears next, move the cursor to **K CONN (M)** and then press the Enter key. This choice presumes that you have a K-Female connector on the device-under-test (DUT). Remember, in this menu you choose the connector type on the test port, or the connector type that *mates* with the DUT connector. When menu C3 returns, observe that **K CONN (M)** is now shown in blue for the **PORT 1 CONN** choice.

MENU C4
SELECT PORT 1 CONNECTOR TYPE
K-CONN (M)
K-CONN (F)
V-CONN (M)
V-CONN (F)
W1-CONN (M)
W1-CONN (F)
SMA (M)
SMA (F)
GPC-3.5 (M)
GPC-3.5 (F)
GPC-7
USER DEFINED
MORE
PRESS <ENTER> TO SELECT

---

MENU C3
CONFIRM CALIBRATION PARAMETERS
PORT 1 CONN K CONN (M)
PORT 2 CONN K CONN (M)
REFLECTION PAIRING MIXED
LOAD TYPE SLIDING
THROUGH PARAMETERS
REFERENCE IMPEDANCE
TEST SIGNALS
START CAL
PRESS <ENTER> TO SELECT OR CHANGE

---

**Step 11.**

With menu C3 (left) displayed, move the cursor to **PORT 2 CONN** and press the Enter key. Following the procedure in Step 10, select **K CONN (M)** for the Port 2 connector.

**Step 12.**

When menu C3 returns:

- a. Observe that **PORT 2 CONN** now reflects **K CONN (M)**.
- b. Move the cursor to **REFLECTION PAIRING** and press the Enter key. This brings up menu C13 (below).

---

MENU C13
SELECT REFLECTION PAIRING
MIXED (OPEN–SHORT SHORT–OPEN)
MATCHED (OPEN–OPEN SHORT–SHORT)
PRESS <ENTER> TO SELECT

---

Reflection Pairing lets you mix or match the Open and Short reflection devices in the Calibration Sequence menus. The **MIXED** choice lets you calibrate using first an Open on one port and a Short on the other, then a Short on one port and an Open on the other. Conversely, **MATCHED** lets you calibrate first using an Open on both ports then using a Short on both ports. For this example, choose **MIXED** and press the Enter key.

**Step 13.**

When menu C3 returns:

MENU C3
CONFIRM CALIBRATION PARAMETERS
PORT 1 CONN TYPE N (M)
PORT 2 CONN TYPE N (F)
REFLECTION PARING MIXED
LOAD TYPE BROADBAND
THROUGH PARAMETERS
REFERENCE IMPEDANCE
TEST SIGNALS
START CAL
PRESS <ENTER> TO SELECT

- Observe that **REFLECTION PARING** now reflects **MIXED**.
- Move cursor to **LOAD TYPE** and press the Enter key. This brings up menu C6 (below).

MENU C6
SELECT TYPE OF LOAD
BROADBAND FIXED LOAD
SLIDING LOAD (MAY ALSO REQUIRE BROADBAND FIXED LOAD)
PRESS <ENTER> TO SELECT

This menu lets you select either of two load types, broadband or sliding. Broadband loads are adequate for all but the most demanding reflection measurements. They are easier to use and less expensive than sliding loads. If you choose a sliding load, refer to paragraph 7-3 for a procedure on setting pin depth.

For this example, select **BROADBAND LOAD** and press the Enter key.

MENU C6A
ENTER BROADBAND LOAD IMPEDANCE
BROADBAND LOAD IMPEDANCE 50.000 $\Omega$
PRESS <ENTER> TO SELECT

- The next menu to appear, C6A (left), prompts you to enter an impedance value. For this example, use the rotary knob to change the displayed value to 50 $\Omega$ . Alternatively, you can key in 50 ohms. That is, press 50 on the keypad and the X1 terminator key. If the value is 1  $\mu\Omega$ , key in .001 and press the 10<sup>-3</sup> terminator key. Conversely, if the value is 1 M $\Omega$ , key in 1000 and press the 10<sup>3</sup> terminator key.

---

<b>MENU C20</b>
ENTER THROUGH LINE PARAMETERS
OFFSET LENGTH 0.0000 mm
THROUGHLINE IMPEDANCE 50.000 Ω
PRESS <ENTER> WHEN COMPLETE

---

**Step 14.**

When menu C3 again returns:

- a. Observe that **LOAD TYPE** now shows **BROADBAND**.
- b. Move cursor to **THROUGH PARAMETERS** and press the Enter key.

**Step 15.**

Menu C20 (left) appears next. It lets you define the length of the offset and the impedance of the throughline. For this example, enter 0 mm for length and 50 ohms for impedance.

**Step 16.**

When menu C3 reappears, move the cursor to **REFERENCE IMPEDANCE** and press the Enter key. This brings up menu C17 (left).

---

<b>MENU C17</b>
ENTER REFERENCE IMPEDANCE
REFERENCE IMPEDANCE 50.000 Ω
PRESS <ENTER> WHEN COMPLETE

---

**Step 17.**

Move cursor to **REFERENCE IMPEDANCE** and use the rotary knob to change the displayed value to 50Ω.

Press the Enter key when you have completed your value entry.

MENU SU2
TEST SIGNALS
POWER CONTROL 0.0 dB (0 TO -20)
PORT 1 ATTN 20 dB (0 - 70)
PORT 1 POWER XX.XX dBm
PORT 2 ATTN X0 dB (0-40)
CALIBRATE FOR FLATNESS (CAL EXISTS)
FLATNESS CORRECTION AT XX.X dBm
SOURCE 2 PWR XX.X dBm
PREVIOUS MENU PRESS <ENTER> TO SELECT

**Step 18.**

When menu C3 returns, select **TEST SIGNALS** to bring up menu SU2 (left).

**Step 19.**

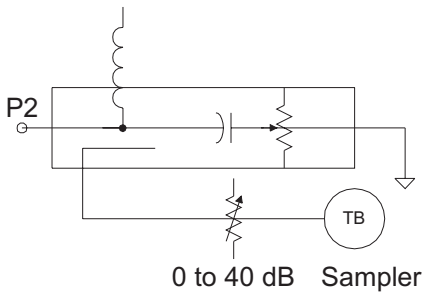
Menu SU2 lets you define the power level of the signals at the two test ports. Power delivered to the DUT by the test set must be such that the measured signals are well above the noise floor but below the 0.1 dB compression level of the Test Set samplers. (Noise floor and maximum signal into Port 2 levels are specified in Appendix C.)

For measuring high power signals, a Port 2 attenuator in the forward transmission path allows up to 1 Watt of power (30 dBm) before 0.1 dB compression occurs.

Determine the required input power level and the expected output RF power level from the DUT. Ideally, the Port 2 step attenuator should be set so that the input to the test sampler (left) is less than -10 dBm. For example, if the input to the DUT is set for -20 dBm and the device gain is 40 dB, set the **PORT 2 ATTN** menu option for 20 dB.

(If you needed to calibrate the test port for power flatness, you would move the cursor to **FLATNESS CORRECTION** and press the Enter key.)

Finally, move the cursor to **PREVIOUS MENU** and press the Enter key. This returns you to menu SU1. When you get there, press the Enter key to return to menu C3.



**Step 20.**

When menu C3 reappears, select **START CAL** and press the Enter key to begin the calibration procedure.

Continue the calibration sequence by following the prompts as they appear. Connect the appropriate Isolation Devices, Broadband Loads, Opens, Shorts, and Throughlines, when requested in the calibration sequence.

---

MENU C3
CONFIRM CALIBRATION PARAMETERS
PORT 1 CONN TYPE N (M)
PORT 2 CONN SMA (M)
REFLECTION PAIRING MIXED
LOAD TYPE SLIDING
THROUGH PARAMETERS
REFERENCE IMPEDANCE
TEST SIGNALS
<b>START CAL</b>
PRESS <ENTER> TO SELECT OR CHANGE

---

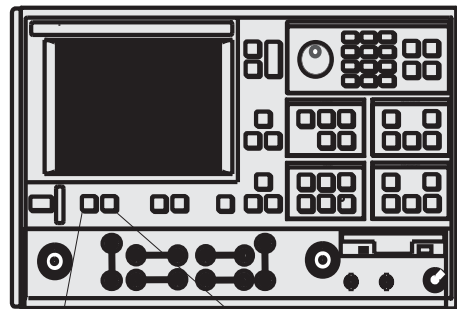
**7-5 OFFSET-SHORT CALIBRATION (SSLT)**

The Offset-Short calibration, now also referred to as the Double Offset-Short Calibration, is the standard technique for waveguide; however, this method can be used for the coaxial and microstrip line types as well. It uses two shorts, two loads, and a thru line to categorize the inherent errors in the waveguide measurement system. These errors include those caused by connectors as well as internal system errors such as RF leakage, IF leakage, and component interaction.

**Calibration Procedure**

A detailed, step-by-step procedure for performing an Offset-Short calibration for waveguide is given below.

**Step 1.** Press the Begin Cal key.



MENU C11
BEGIN CALIBRATION
KEEP EXISTING CAL DATA
REPEAT PREVIOUS CAL
AUTOCAL
CAL METHOD XXXXXXX
TRANSMISSION LINE TYPE: XXXXXXX
<b>CHANGE CAL METHOD AND LINE TYPE</b>
NEXT CAL STEP
PRESS <ENTER> TO SELECT

**Step 2.** Select **CHANGE CAL METHOD AND LINE TYPE**, in menu C11 (left). (This assumes OFFSET SHORT and WAVEGUIDE are not presently shown in blue as being selected.)



MENU C11A
CHANGE CAL METHOD AND LINE TYPE
NEXT CAL STEP
CAL METHOD
SOLT (STANDARD)
SSLT (DOUBLE OFFSET SHORT WITH LOAD)
SSST (TRIPLE OFFSET SHORT)
LRL/LRM
TRM
TRANSMISSION LINE TYPE
COAXIAL
WAVEGUIDE
MICROSTRIP
PRESS <ENTER> TO SELECT

**Step 3.**

When menu C11A (left) appears, move cursor to the following:

- a. **SSLT (DOUBLE OFFSET SHORT)**, then press the Enter key. This selects Offset Short as the calibration method.
- b. **WAVEGUIDE**, then press the Enter key. This brings menu C5 (bottom left) to the screen.
- c. **NEXT CAL STEP**, then press the Enter key. This causes menu C11 to return to the screen.

**Step 4.**

When menu C11 reappears, confirm that the **OFFSET SHORT** calibration method and **WAVEGUIDE** line-type have been selected. Select **NEXT CAL STEP** and press the Enter key to proceed.

**Step 5.**

Menu C5 appears next. This menu (bottom left) lets you select the type of calibration. For this example, move the cursor to **FULL 12-TERM** and press the Enter key.

**Step 6.**

The next menu, C5D (below), lets you choose whether to include or exclude the error terms associated with leakage between measurement channels. For a normal calibration, you would choose to include these error terms. Therefore, move the cursor to **INCLUDE ISOLATION (STANDARD)** and press the Enter key.

MENU C5
SELECT CALIBRATION TYPE
FULL 12-TERM
1 PATH
2 PORT
TRANSMISSION FREQUENCY RESPONSE
REFLECTION ONLY
PRESS <ENTER> TO SELECT

MENU C5D
SELECT USE OF ISOLATION IN CALIBRATION
INCLUDE ISOLATION (STANDARD)
EXCLUDE ISOLATION
PRESS <ENTER> TO SELECT

MENU C1
SELECT CALIBRATION DATA POINTS
<b>NORMAL</b> (1601 POINTS MAXIMUM)
C.W. (1 POINT)
N-DISCRETE FREQUENCIES (2 TO 1601 POINTS)
TIME DOMAIN (HARMONIC)
PRESS <ENTER> TO SELECT

**Step 7.**

Menu C1 (left), which appears next, lets you select the number of frequency points at which calibration data is to be taken. Of these choices, which were described in paragraph 7-4, choose **NORMAL (1601 POINTS MAXIMUM)** for this example.

**Step 8.**

The next menu, C2 (below), lets you set your start and stop frequencies. For this example, move cursor to **START**, press 40 on keypad, and press the MHz terminator key. Perform like operations for the **STOP** choice, except make entry read 20 GHz. After setting the frequencies, select **NEXT CAL STEP** and press the Enter key.

MENU C2
FREQ RANGE OF CALIBRATION
<b>START</b> 0.0400000000GHz
<b>STOP</b> 20.000000000 GHz
201 DATA PTS 0.099800000 GHz STEP SIZE
MAXIMUM NUMBER OF DATA POINTS
1601 MAX PTS
801 MAX PTS
401 MAX PTS
<b>201 MAX PTS</b>
101 MAX PTS
51 MAX PTS
<b>NEXT CAL STEP</b>
PRESS <ENTER> TO SELECT

MENU C3B
CONFIRM CALIBRATION PARAMETERS
<b>WAVEGUIDE</b> PARAMETERS INSTALLED
REFLECTION PAIRING XXXXXXXX
LOAD TYPE BROADBAND
THROUGH LINE PARAMETERS
TEST SIGNALS
<b>START CAL</b>
PRESS <ENTER> TO SELECT OR CHANGE

**Step 9.**

When menu C3B (bottom left) appears, if you want to change any of the parameters shown in blue letters, place the cursor on that parameter and press the Enter key. (These choices operate the same as was described for menu C3 in section 7-4.) For this example, we change the waveguide parameters. Move the cursor to **WAVEGUIDE PARAMETERS** and press the Enter key.

**Step 10.**

When menu C15 (left) appears, move cursor to one of the two available choices and press the Enter key. These choices are described below.

```
MENU C15
-----
SELECT
WAVEGUIDE
KIT TO USE
-INSTALLED KIT-
IDENTIFIER
  XXXX
CUTOFF FREQ:
XXX.XXXXXXXXXX GHz
SHORT 1
  XX.XXXX mm
SHORT 2
  XX.XXXX mm
USE INSTALLED
WAVEGUIDE KIT
USER DEFINED
PRESS <ENTER>
  TO SELECT
```

- a. **USE INSTALLED WAVEGUIDE KIT:** Selecting this choice uses the values shown in blue for IDENTIFIER, CUTOFF FREQ, SHORT 1, and SHORT 2. Select this choice, for this example.
- b. **USER DEFINED:** Selecting this choice brings up menu C15A (below), which lets you specify waveguide parameters. After defining your waveguide parameters, you are returned to menu C3B.

```
MENU C15A
-----
ENTER
WAVEGUIDE
PARAMETERS
WAVEGUIDE
CUTOFF FREQ:
XXX.XXXXXXXXXX GHz
OFFSET LENGTH
OF SHORT 1
  XX.XXXX mm
OFFSET LENGTH
OF SHORT 2
  XX.XXXX mm
PRESS <ENTER>
  WHEN COMPLETE
```

**Step 11.**

Continue the calibration sequence by following the prompts as they appear. Connect the appropriate Isolation Devices, Broadband Loads, Shorts, and Throughlines, when requested in the calibration sequence.

**7-6 TRIPLE OFFSET-SHORT  
CALIBRATION (SSST)**

The Triple Offset-Short calibration method can be used in coax, waveguide, and microstrip line types, and is most accurate when used over narrower frequency ranges. As the name implies, this method uses three offset-shorts to categorize the inherent errors in the measurement system. These errors include those caused by connectors as well as internal system errors such as RF leakage, IF leakage, and component interaction.

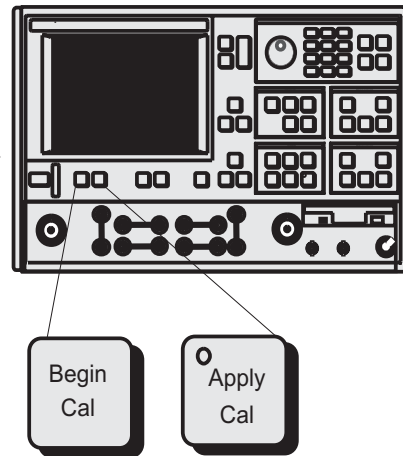
**NOTE**

A continuous single sweep broadband calibration from 40 MHz to 110 GHz can be created by merging a 40 MHz to 65 GHz SOLT calibration with a 65 GHz to 110 GHz SSST calibration. For more information, refer to section 7-9, Merge Cal Files, and to Chapter 15 for details about the broadband mode of operation.

**Calibration Procedure**

A detailed, step-by-step procedure for performing a Triple Offset-Short calibration is given below:

**Step 1.** Press the Begin Cal key.



MENU C11
BEGIN CALIBRATION
KEEP EXISTING CAL DATA
REPEAT PREVIOUS CAL
AUTOCAL
CAL METHOD STANDARD
TRANSMISSION LINE TYPE: XXXXXXXX
CHANGE CAL METHOD AND LINE TYPE
NEXT CAL STEP
PRESS <ENTER> TO SELECT

**Step 2.** Select **CHANGE CAL METHOD AND LINE TYPE**, in menu C11 (left). (This assumes that OFF-SET SHORT and WAVEGUIDE are not presently shown in blue as being selected.)

**Step 3.**

When menu C11A (left) appears, move cursor to the following:

MENU C11A
CHANGE CAL METHOD AND LINE TYPE
NEXT CAL STEP
CAL METHOD
SOLT (STANDARD)
SSLT (DOUBLE OFF- SET SHORT WITH LOAD)
SSST (TRIPLE OFFSET SHORT)
LRL/LRM
TRM
TRANSMISSION LINE TYPE
COAXIAL
WAVEGUIDE
MICROSTRIP
PRESS <ENTER> TO SELECT

- a. **SSST (TRIPLE OFFSET SHORT)**, then press the Enter key. This selects Triple Offset-Short as the calibration method.
- b. **COAXIAL**, then press the Enter key. This brings menu C5 (left) to the screen.
- c. **NEXT CAL STEP**, then press the Enter key. This causes menu C11 to return to the screen.

**Step 4.**

When menu C11 reappears, confirm that the SSST calibration method and COAXIAL line-type have been selected. Select **NEXT CAL STEP** and press the Enter key to proceed.

**Step 5.**

Menu C5 appears next (lower left). This menu lets you select the type of calibration. For this example, move the cursor to **FULL 12-TERM** and press the Enter key.

**Step 6.**

The next menu, C5D (below), lets you choose whether to include or exclude the error terms associated with leakage between measurement channels. For a normal calibration, you would choose to include these error terms. Therefore, move the cursor to **INCLUDE ISOLATION (STANDARD)** and press the Enter key.

Menu C5
CALIBRATION TYPE
FULL 12-TERM
1 PATH
2 PORT
TRANSMISSION FREQUENCY RESPONSE
REFLECTION ONLY
PRESS <ENTER> TO SELECT

Menu C5D
SELECT USE OF ISLOATION IN CALIBRATION
INCLUDE ISOLATION (STANDARD)
EXCLUDE ISOLATION
PRESS <ENTER> TO SELECT

**Step 7.**

Menu C1 appears next (left) and lets you select the number of frequency points for which calibration data is to be taken. Select **NORMAL (1601 POINTS MAXIMUM)** (refer to section 7-4 for a description).

MENU C1
SELECT CALIBRATION DATA POINTS
<b>NORMAL (1601 POINTS MAXIMUM)</b>
C.W. (1 POINT)
N-DISCRETE FREQUENCIES (2 TO 1601 POINTS)
TIME DOMAIN (HARMONIC)
PRESS <ENTER> TO SELECT

**Step 8.**

The next menu, C2 (below), lets you set your start and stop frequencies. For this example, move the cursor to **START**, press 65 on the keypad, then press the GHz terminator key. Perform like operations for the **STOP** choice, except make the entry read 110 GHz. After setting the frequencies, select **NEXT CAL STEP** and press the Enter key.

MENU C2
FREQ RANGE OF CALIBRATION
<b>START</b> 0.0400000000GHz
<b>STOP</b> 20.000000000 GHz
201 DATA PTS 0.099800000 GHz STEP SIZE
MAXIMUM NUMBER OF DATA POINTS
1601 MAX PTS
801 MAX PTS
401 MAX PTS
<b>201 MAX PTS</b>
101 MAX PTS
51 MAX PTS
<b>NEXT CAL STEP</b>
PRESS <ENTER> TO SELECT

**Step 9.**

This brings up the Menu C14 (lower left) for selecting the connector types on ports 1 and 2. Select the **W1-CONN** connectors with the appropriate sex for a W1 (1mm) calibration.

Menu C14
SELECT PORT n OFFSET SHORT CONNECTOR TYPE
W1-CONN (M)
W1-CONN (F)
SPECIAL A (M)
SPECIAL A (F)
SPECIAL B (M)
SPECIAL B (F)
SPECIAL C (M)
SPECIAL C (F)
USER DEFINED
PRESS <ENTER> TO SELECT

MENU C3B
CONFIRM CALIBRATION PARAMETERS
WAVEGUIDE PARAMETERS INSTALLED
REFLECTION PAIRING MIXED
LOAD TYPE BROADBAND
THROUGH LINE PARAMETERS
TEST SIGNALS
<b>START CAL</b>
PRESS <ENTER> TO SELECT OR CHANGE

**Step 10.**

When menu C3B (left) appears, if you want to change any of the parameters shown in blue letters, place the cursor on that parameter and press the Enter key.

**Step 11.**

When menu C3 (lower left) returns:

- a. Observe that PORT 1 CONN and PORT 2 CONN now reflects W1 CONN (M).
- b. Move the cursor to **REFLECTION PAIRING** and press the Enter key. This brings up menu C13 (below).

MENU C3
CONFIRM CALIBRATION PARAMETERS
<b>PORT 1 CONN</b> W1-CONN (M)
<b>PORT 2 CONN</b> W1-CONN (M)
<b>REFLECTION PAIRING</b> XXXXXXXX
LOAD TYPE BROADBAND
THROUGH LINE PARAMETERS
REFERENCE IMPEDANCE
TEST SIGNALS
<b>START CAL</b>
PRESS <ENTER> TO SELECT OR CHANGE

MENU C13
SELECT REFLECTION PAIRING
<b>MIXED</b> (SHORT1-SHORT2, SHORT2-SHORT3, SHORT3-SHORT1)
MATCHED (SHORT1-SHORT1, SHORT2-SHORT2, SHORT3-SHORT3)
PRESS <ENTER> TO SELECT OR CHANGE

**Step 12.**

Reflection Pairing lets you mix or match Offset Short devices in the Calibration Sequence menus, as per the kit available. Generally, on-wafer calibration substrates have matched components; however, it is more convenient, on a coaxial calibration, to use MIXED pairing in the case of the same connector types on both ports. The MIXED choice lets you calibrate using different offset shorts on the two ports. Conversely, MATCHED pairing lets you calibrate in sequence using one offset short type in each step. For this example, choose **MIXED** and press the Enter key.

**Step 13.**

When menu C3 reappears, confirm the calibration parameters selected for the calibration, then select **START CAL** and continue the calibration sequence by following the prompts as they appear.

**Step 14.**

Connect the appropriate Isolation Devices, the three Offset Shorts, and the Throughlines when requested in the calibration sequence.

**7-7 LRL/LRM CALIBRATION**

The LRL/LRM (line-reflect-line/line-reflect-match) calibration\* feature provides an enhanced capability for error compensation when making measurements in coaxial, microstrip and waveguide transmission media. Instead of using the standard Open, Short, and Load, the LRL/LRM calibration method uses two lines and a reflection or match. The difference in length between line 1 and line 2 creates the measurements necessary for the error solutions.

The LRL/LRM calibration technique uses the characteristic impedance of a length of transmission line or a precision match as the calibration standard. A full LRL/LRM calibration consists of two transmission line measurements, a high reflection measurement, and an isolation measurement. Using this technique full 12-term error correction can be performed with the 37XXXD.

Three-line LRL/LRM calibration can also be selected. In a two-line LRL measurement, the difference in length between line one and line two is necessary for calibration but limits the frequency range to a 9:1 span. The use of three lines in the calibration extends the frequency range to an 81:1 span. A combination of LRL and LRM can accommodate any broadband measurement.

1. Through the use of LRL/LRM calibration and an external computer, in conjunction with ANACAT software, multiple-level de-embedding is possible. This calibration allows you to make semiconductor chip measurements up to 40 GHz with a single test fixture.
2. In addition, any non-coaxial transmission media, including mixed media interconnects, can be accommodated. For example, a test device with a waveguide input and a coplanar microstrip output can be measured. Software automatically compensates for the microstrip dispersion.

A detailed procedure for calibrating for a measurement using the LRL/LRM method is provided in the following pages.

---

\*LRM Calibration Method of Rhode & Scharwz, Germany



**LRL/LRM Calibration  
(Microstrip)**

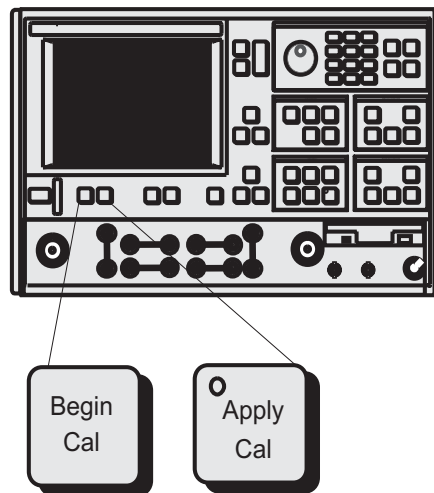
Microstrip is a dispersive media. The 37XXXD applies dispersion compensation during calibration for microstrip measurements. Because the 37XXXD must know the specific microstrip parameters, during the calibration procedure menus are available for entering the:

- width of the strip
- thickness of the substrate
- substrate dielectric constant
- effective dielectric constant  $Z_c$
- characteristic impedance (reference)

When testing microstrip devices it is necessary to launch from coax to microstrip. In production testing this launching must be temporary, so that the device can easily be installed in and be removed from the fixture. The requirement for launching to 65 GHz is met by the Anritsu Universal Test Fixture (UTF). The UTF provides accurate, repeatable launch to substrates from 5 to 70 mils thick, and from 0.15 to 2 inches long. Offset connections and right angles can be configured. DC bias probes can be mounted to the UTF to inject bias onto the substrate. UTF calibration/verification kits are available for alumina in 10 mil, 15 mil, and 25 mil microstrip, and for 25 mil coplanar waveguide. Although a UTF is not essential, the following calibration procedures presume its use.

**Step 1.** Select the desired LRL line substrates from the appropriate microstrip calibration kit. When called for in the calibration sequence, mount the LRL line substrates on the UTF following the procedure given in the 3680 OMM.

**Step 2.** Press the Begin Cal key.



MENU C11
BEGIN CALIBRATION
KEEP EXISTING CAL DATA
REPEAT PREVIOUS CAL
AUTOCAL
CAL METHOD XXXXXXXX
TRANSMISSION LINE TYPE: XXXXXXXX
CHANGE CAL METHOD AND LINE TYPE
NEXT CAL STEP
PRESS <ENTER> TO SELECT

**Step 3.**

Select **CHANGE CAL METHOD AND LINE TYPE**, in menu C11 (left). (This assumes LRL and MICROSTRIP are not presently shown in blue as being selected.)

**Step 4.**

When menu C11A (bottom left) appears, highlight the following selections.

- a. **LRL/LRM** and press the Enter key.
- b. **MICROSTRIP** and press the Enter key.
- c. **NEXT CAL STEP** and press the Enter key.

**Step 5.**

When menu C11 reappears, confirm that the **LRL/LRM** calibration method and **MICROSTRIP** line-type have been selected. Select **NEXT CAL STEP** and press the Enter key to proceed.

**Step 6.**

Continue through the calibration sequence, and make the following selections from the menus that appear:

**INCLUDE ISOLATION (STANDARD)** (Menu C5D)

**NORMAL (1601 POINTS MAXIMUM)** (Menu C1)

**START** (Your start frequency) (Menu C2)

**STOP** (Your stop frequency) (Menu C2)

MENU C11A
CHANGE CAL METHOD AND LINE TYPE
NEXT CAL STEP
CAL METHOD
SOLT (STANDARD)
SSLT (DOUBLE OFF-SET SHORT WITH LOAD)
SSST (TRIPLE OFF-SET SHORT)
LRL/LRM
TRM
TRANSMISSION LINE TYPE
COAXIAL
WAVEGUIDE
MICROSTRIP
PRESS <ENTER> TO SELECT

MENU C5D
SELECT USE OF ISOLATION IN CALIBRATION
INCLUDE ISOLATION (STANDARD)
EXCLUDE ISOLATION
PRESS <ENTER> TO SELECT

MENU C1
SELECT CALIBRATION DATA POINTS
NORMAL (1601 POINTS MAXIMUM)
C.W. (1 POINT)
N-DISCRETE FREQUENCIES (2 TO 1601 POINTS)
TIME DOMAIN (HARMONIC)
PRESS <ENTER> TO SELECT

MENU C2
FREQ RANGE OF CALIBRATION
START 0.0400000000GHz
STOP 20.000000000 GHz
201 DATA PTS 0.099800000 GHz STEP SIZE
MAXIMUM NUMBER OF DATA POINTS 1601 MAX PTS 801 MAX PTS 401 MAX PTS <b>201 MAX PTS</b> 101 MAX PTS 51 MAX PTS
NEXT CAL STEP
PRESS <ENTER> TO SELECT

**Step 7.**

When menu C3G appears, if you want to change microstrip parameters to be different from those shown in blue, place the cursor on **MICROSTRIP PARAMETERS** and press the Enter key.

<b>MENU C3G</b>
CONFIRM CALIBRATION PARAMETERS
LRL/LRM PARAMETERS
MICROSTRIP PARAMETERS
USER DEFINED
TEST SIGNALS
START CAL
PRESS <ENTER> TO SELECT OR CHANGE

**Step 8.**

When menu C16 (left) appears, move the cursor to the Anritsu 3680 UTF calibration kit you wish to use or to **USER DEFINED**; then press the Enter key.

The calibration kit selections shown in menu C16 are for the following 3680 Connection Substrate Kits:

- 10 MIL KIT — 36804B-10M
- 15 MIL KIT — 36804B-15M
- 25 MIL KIT — 36804B-25M

If you choose **USER DEFINED**, the next menu that appears (C16A), lets you characterize your parameters. Move the cursor to each selection, key in a value, then press the Enter key to return to menu C16.

<b>MENU C16</b>
SELECT MICROSTRIP KIT TO USE
10 MIL KIT
15 MIL KIT
25 MIL KIT
USER DEFINED
PRESS <ENTER> WHEN COMPLETE

<b>MENU C16A</b>
ENTER MICROSTRIP PARAMETERS
WIDTH OF STRIP XX.XXXX mm
THICKNESS OF SUBSTRATE XXXX.XXXX mm
Zc XXX.XXX pΩ
SUBSTRATE DIELECTRIC XX.XX
EFFECTIVE DIELECTRIC XX.XX (RECOMMENDED 0.00)
PRESS <ENTER> WHEN COMPLETE

---

<b>MENU C3G</b>
CONFIRM CALIBRATION PARAMETERS
LRL/LRM PARAMETERS
CHANGE MICROSTRIP PARAMETERS XXXXXXXXXX
START CAL
PRESS <ENTER> TO SELECT

---

**Step 9.**

Select **LRL/LRM PARAMETERS**, when menu C3G returns.

**Step 10.**

When menu C18 appears, you have two choices to make: whether your calibration is to be two-line or three-line, and where you want to have your reference plane.

- a. *Select the reference plane:* Highlight **MIDDLE OF LINE 1 (REF)** or **ENDS OF LINE 1 (REF)** and press the Enter key.
- b. *Select the type of LRL/LRM calibration:* Highlight **ONE BAND** for a two-line calibration or **TWO BANDS** for a three-line calibration.

As mentioned earlier in a two-line measurement, the difference in length between line 1 and line 2 is necessary for calibration, but limits the frequency range to a 9:1 span. By using three lines in the calibration, you extend the frequency range to an 81:1 span.

If you select **TWO BANDS**, skip to Step 12.

---

<b>MENU C18</b>
CHANGE LRL/LRM PARAMETERS
NEXT CAL STEP
NUMBER OF BANDS USED
ONE BAND
TWO BANDS
LOCATION OF REFERENCE PLANES
MIDDLE OF LINE 1 (REF)
ENDS OF LINE 1 (REF)
PRESS <ENTER> TO SELECT

---

**Step 11.**

When menu C18A (left) appears, make the following selections (for 2-line):

---

<b>MENU C18A</b>
CHANGE LRL/LRM PARAMETERS
<b>NEXT CAL STEP</b>
CHARACTERIZE CAL DEVICES
DEVICE 1 LINE 1 (REF) X.XXXX mm
DEVICE 2 LINE /MATCH X.XXXX mm
PRESS <ENTER> TO SELECT OR SWITCH

---

- a. Move the cursor to **DEVICE 1 LINE 1 (REF)** and key in the value.
- b. Move the cursor to **DEVICE 2 LINE/MATCH**. Here you have another decision to make: whether your calibration is to be LRL or LRM. For this selection, the Enter key acts as a toggle.
- c. If you toggle such that **LINE** turns red, then key in the value for line 2. This value depends on your frequency range.
- d. If you toggle **MATCH** red, observe that **FULLBAND** appears. This indicates that your reflective device covers the full calibration range.
- e. When you have made both selections, move the cursor to **NEXT CAL STEP** and press the Enter key to produce the next menu. Skip to Step 13.

**Step 12.**

<b>MENU C18B</b>
CHANGE LRL/LRM PARAMETERS
<b>NEXT CAL STEP</b>
CHARACTERIZE CAL DEVICES
DEVICE 1 LINE 1 (REF) XX.XXXX
DEVICE 2 LINE/MATCH XX.XXXX/LOWBAND
DEVICE 3 LINE/MATCH XX.XXXX/HIGHBAND
FREQ AFTER WHICH THE USE OF DEVICE 2 AND DEVICE 3 IS EXCHANGED
<b>BREAKPOINT</b> XXX.XXXXXXXXXXGHZ
PRESS <ENTER> TO SELECT OR SWITCH

When menu C18B (left) appears, make the following selections (for 3-line):

- a. Move the cursor to **DEVICE 1 LINE 1 (REF)** and key in the value (typically 1.00 cm). Press the Enter key to select.
- b. Move the cursor to **DEVICE 2 LINE/MATCH**. Both here, and for the next choice, you have another decision to make: whether your calibration is to be LRL or LRM. For this selection, the Enter key acts as a toggle.
- c. If you toggle such that **LINE** turns red, then key in the value for line 2. This value depends on your frequency range.
- d. If you toggle **MATCH** red, observe that **LOWBAND** appears. This indicates that your reflection device is a low-band load. This load must have a passband such that it passes all frequencies from the start to the breakpoint (see below).
- e. Move the cursor to **DEVICE 3 LINE/MATCH**. If device 3 is a line, key in the value. If it is a match, the term **HIGHBAND** will appear. This indicates that your match is a high-band load. This load must have a passband such that it passes all frequencies from the breakpoint to the stop frequency.
- f. Move the cursor to **BREAKPOINT** and enter your breakpoint frequency. For two-line LRL calibrations, select a breakpoint equal to the upper frequency of the low frequency LRL line. For a combined LRL and LRM calibration, select a breakpoint equal to the top frequency of the calibration divided by six; for instance, to cover the frequency range 0.04 to 60 GHz, select 10 GHz as the breakpoint.
- g. When you have made all selections, move the cursor to **NEXT CAL STEP** and press Enter to produce the next menu.

<b>MENU C19</b>
CHANGE LRL/LRM PARAMETERS
NEXT CAL STEP
REFLECTION OFFSET LENGTH +XXX.XXXX mm
REFLECTION TYPE
GREATER THAN $Z_0$
LESS THAN $Z_0$
MATCH PARAMETERS
MATCH IMPEDANCE +XXX.XXX $\Omega$
MATCH INDUCTANCE +XXXX.XXXX pH
PRESS <ENTER> TO SELECT

**Step 13.**

The next menu, C19, gives you choices for your reflective device.

- a. Move the cursor to **REFLECTION OFFSET LENGTH** and key in a value (typically 0.0000 mm).
- b. Move the cursor to **GREATER THAN  $Z_0$**  or **LESS THAN  $Z_0$** , depending on whether your reflective device is an Open or a Short. Press the Enter key to select.

**NOTE**

Choose **GREATER THAN  $Z_0$**  for an Open and **LESS THAN  $Z_0$**  for a Short.

- c. When you complete your choices, move the cursor to **NEXT CAL STEP** and press the Enter key.

**Step 14.**

When menu C3G reappears, move cursor to **START CAL** and press Enter.

**Step 15.**

Continue the calibration sequence by following the prompts as they appear. Mount the appropriate LRL line substrates when requested in the calibration sequence.

For the **REFLECTIVE DEVICE** and **BROADBAND LOAD** prompts, remove all substrates from the UTF and allow the lower jaws to short the center conductor. Separate the connector blocks by at least an inch. (The **BROADBAND LOAD** prompt only appears if you selected to include isolation in menu C5B.)

<b>MENU C3G</b>
CONFIRM CALIBRATION PARAMETERS
CHANGE LRL/LRM PARAMETERS
CHANGE MICROSTRIP PARAMETERS XXXXXXXXXX
START CAL
PRESS <ENTER> TO SELECT

**Step 16.**

Store the calibration.

**LRL/LRM Calibration  
(Coaxial)**

An LRL cal kit is necessary to perform the coaxial calibration. Calibration kits for GPC-7 are available from Maury Microwave and Hewlett Packard.

Two line lengths are used as the impedance standard. The calibration frequency range is limited by the difference in the lengths of the two lines. Their length must be different by approximately 90 degrees at the mid-band frequency. A good calibration can be achieved over the range of 18 degrees to 162 degrees making it possible to calibrate LRL over a 9:1 frequency range.

LRL calibration is very sensitive to uncalibrated source match. If some padding is placed at the test ports, the directivity and source match will be improved. If the goal is high level measurements, then padding should be included. If low level measurements are being performed, then the padding must be left out.

<b>MENU C3E</b>
CONFIRM CALIBRATION PARAMETERS
LRL/LRM PARAMETERS
REFERENCE IMPEDANCE
TEST SIGNALS
START CAL
PRESS <ENTER> TO SELECT OR CHANGE

**Step 1.** Same as Steps 1 through 6 in the Microstrip procedure, except choose **COAXIAL** in menu C11A.

**Step 2.** When menu C3E (left) appears, if you want to change line impedance, place cursor on **REFERENCE IMPEDANCE** and press the Enter key.

**Step 3.** When menu C17 (left) appears, move cursor to **REFERENCE IMPEDANCE**, key in the value, then press the Enter key.

**Step 4.** Same as Steps 9 through 16 in the microstrip procedure.

In the coaxial, three-line calibration there are factors you need to be aware of. Note that it is the line length *differences* that are important to the LRL calibration, namely (L2-L1) and (L3-L1) where L1 is the length of line 1, L2 is the length of line 2, and L3 is the length of line 3.

Longer length differences are used for longer wavelengths (lower frequencies). For frequencies up to and including the breakpoint frequency, the larger absolute value of the (L2-L1) and (L3-L1) differences is used. At frequencies above the breakpoint, the smaller absolute value of the (L2-L1) and (L3-L1) differences is used.

<b>MENU C17</b>
ENTER REFERENCE IMPEDANCE
REFERENCE IMPEDANCE 50.000 Ω
PRESS <ENTER> WHEN COMPLETE



Consideration must also be given to selecting the breakpoint frequency. Divide the frequency range to satisfy the 9:1 rule for any given pair of lines. The range is thus divided by the frequency breakpoint into the intervals [f1, f2] and [f2, f3]. Based on these intervals, next determine the appropriate length differences; the longer difference is associated with the lower interval [f1, f2]. Note that if the differences are equal to each other, concurrent frequency ranges are implied and only two lines need be used.

Select a line 1 reference (L1) around which to place these two differences. Use any combination of positive or negative differences around line 1. The software selects which interval is associated with either of line 2 or line 3 by comparing the absolute values of the differences with line 1. Data from the two lines, which make up the larger absolute difference, are used for the interval [f1, f2]. Data from the two lines, which make up the smaller absolute difference, are used for the interval [f2, f3].

**LRL/LRM Calibration  
(Waveguide)**

The waveguide procedure is very similar to the coaxial and microstrip procedures already described.

---

<b>MENU C3F</b>
CONFIRM CALIBRATION PARAMETERS
LRL/LRM PARAMETERS
WAVEGUIDE CUTOFF FREQ
TEST SIGNALS
START CAL
PRESS <ENTER> TO SELECT OR CHANGE

---

**Step 1.**

Follow Steps 1 through 6 in the Microstrip procedure, page 7-37, except choose **WAVEGUIDE** in menu C11A.

The only difference is with menu C3F (left). For a waveguide calibration, move the cursor to **WAVEGUIDE CUTOFF FREQ** and press Enter. This action calls menu C15B, which lets you enter the waveguide cutoff frequency. After doing so, you are returned to menu C3F.

**Step 2.**

When menu C3F reappears, place cursor on **CHANGE LRL/LRM PARAMETERS** and press the Enter key.

**Step 3.**

Follow Steps 9 through 13, page 7-40, in the Microstrip procedure.

---

<b>MENU C15B</b>
ENTER WAVEGUIDE CUTOFF FREQUENCY
WAVEGUIDE CUTOFF FREQ XX.XXXX GHz
PRESS <ENTER> WHEN COMPLETE

---

**7-8 TRM CALIBRATION**

The TRM Calibration procedure is the same as the LRL/LRM procedure, previous page, except that certain parameters have been set by default so that the calibration is simpler to perform (e.g., the L-parameter in the LRM calibration has been set to equal a length of 0 mm for a through, and the R-parameter is set for a short).

## 7-9 MERGE CAL FILES APPLICATION

The Merge Cal Files application allows the user to combine two or more calibrations that were performed on the VNA, but having differing frequency ranges. This is of particular importance when a wide band RF calibration cannot be performed because wide band calibration components, such as loads and shorts, are not available. Such a case exists when using Anritsu's 37X97D wideband VNAs. Here, the preferred calibration method would be to perform a standard method (SOLT) coaxial calibration in the 0.04 to 65 GHz bands, a triple offset-short (SSST) coaxial calibration in the 65 to 110 GHz band, then combine the calibrations to yield a wideband 0.04 to 110 GHz calibration that can be saved and recalled.

The resultant calibration file setup will be the first calibration file setup except that the frequency points and RF correction values of the second calibration file will be intermingled with the frequency points and RF correction values of the first. The start and stop frequencies will be adjusted to reflect the lowest and highest frequencies in the intermingling. If there are frequency points in common, then the correction values of the first file will be used and that frequency and data point in the second file will be discarded.

Both RF calibration files must be the same type, that is, full 12 Term, 1 Path 2 Port Forward, 1 Path 2 Port Reverse, etc., and the total number of frequency points of the first and second files added together cannot exceed 1601.

In most cases, it doesn't matter which calibration file is chosen as the first calibration file; however, if the VNA is a 37397C used in a Broadband setup that crosses the 65 GHz switchpoint, it is advised that the first calibration data be from the lower frequency band and the second calibration data be from the higher frequency band. Additionally, if the higher frequency band calibration starts at 65.0 GHz, the lower frequency band calibration must end at 65.0 GHz. This will prevent a spike at the 65.0 GHz band switch point.

### **NOTE**

Refer to Appendix A, Front Panel Menus, for descriptions of menus MRG1, EXT\_MRG1, MRG2, and MRG3 that relate to this application.



# Chapter 8

## Measurements

### Table of Contents

---

8-1	INTRODUCTION . . . . .	8-3
8-2	TRANSMISSION AND REFLECTION . . . . .	8-3
8-3	LOW LEVEL AND GAIN . . . . .	8-12
8-4	GROUP DELAY . . . . .	8-20
8-5	ACTIVE DEVICE . . . . .	8-24
8-6	MULTIPLE SOURCE CONTROL . . . . .	8-29
	Control Formula . . . . .	8-29
8-7	ADAPTER REMOVAL . . . . .	8-34
8-8	GAIN COMPRESSION . . . . .	8-39
	Power and VNAs . . . . .	8-39
	Swept Power Gain Compression . . . . .	8-41
	Swept Frequency Gain Compression . . . . .	8-41
8-9	RECEIVER MODE . . . . .	8-58
	Source Lock Mode . . . . .	8-58
	Tracking Mode . . . . .	8-58
	Set-on Mode . . . . .	8-58
	Receiver Mode Block Diagram . . . . .	8-59
	Receiver Mode Menus . . . . .	8-59
	Procedure, Receiver Mode Operation . . . . .	8-59
8-10	EMBEDDING/ DE-EMBEDDING . . . . .	8-62
	Embedding . . . . .	8-63
	De-embedding . . . . .	8-64
8-11	OPTICAL APPLICATION . . . . .	8-65
	E/O Measurements . . . . .	8-65
	O/E Measurements . . . . .	8-68
	Creating a Characterization (*.S2P) File for E/O and O/E Measurements . . . . .	8-74



# Chapter 8

## Measurements

### **8-1** INTRODUCTION

This section discusses typical measurements that can be made with the Model 37XXXD Vector Network Analyzer.

### **8-2** TRANSMISSION AND REFLECTION

This discussion provides information on general measurement considerations and transmission and reflection measurements using the 37XXXD.

#### **Setup and Calibration**

To get started, apply power to the system.

After turning on the power, allow the system to warm up for at least 60 minutes before operation.

In normal operation, the system comes on line in the state that it was in when last turned off. If you want to return the system to its default state, you can do so by pressing the Default Program key twice.

The default parameters provide a known starting point. For example, they reset the start and stop frequencies for maximum sweep width, the source control to 0 dB, and the display resolution to 401 data points.

The Sweep Setup menu should now appear on the display (it also can be displayed using the Setup Menu key). If you like, you can select a new start frequency, stop frequency, or source power.

You can further reduce the power level at Ports 1 and 2 with the built-in attenuators. Using the Reduced Test Signals option in the Sweep Setup menu, you can change the setting of the Port 1 source attenuator over a range of from 0 to 70 dB. The Port 2 test attenuator has a range of from 0 to 40 dB (in 10 dB steps) (if Option 6 is installed).

Install the calibration kit devices to the test ports as instructed by the U3 menu. Both the capacitance coefficients for the Open and the offset lengths for the Open and Short can be modified or defined.

Selecting the Begin Cal key starts the calibration process. The Calibration menus step you through the calibration process, as follows:

Select the type of calibration desired.

Select the frequency range of calibration. Using the Data Points key, you can choose from 51 up to 1601 measurement data points.

When the calibration is completed, you can store the calibration data on a disk. You are now ready to install the test device and proceed with the measurement. At this point you have a number of measurement options to consider such as displays, markers, limits, outputs, sweeps, and enhancements.

You can select any of the available graph types and display them for any calibrated parameter on any of the four channels (if a 12-term calibration was performed).

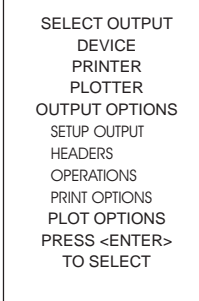


Up to six markers are available. Using the Marker Menu, you can set the frequency of each one, you can set each one in the delta marker mode, and you can set each marker's level to maximum or minimum.

In some cases—such as in a production environment—limit lines are desirable. Options within the menu called up using the Limits key, provide for one or two flat, sloped, or single-point-segmented limit lines for each channel. These limit lines function with all of the graph types, including Smith and admittance. The color of the limit lines (blue) differs from that of the measurement trace. This allows for easy analysis of results.

The Hard Copy Menu key menu (Figure 8-1) gives you a choice between a printer and a colored-pen plotter. It also lets you select menus from which you may chose from a variety of print or plot options. To output the display, press the Start Print key. The default setting provides for a full display printout from the associated printer.

---

A rectangular box containing the text of the 'Output Menu' screen. The text is centered and lists various options for outputting the display.

```
SELECT OUTPUT
DEVICE
PRINTER
PLOTTER
OUTPUT OPTIONS
SETUP OUTPUT
HEADERS
OPERATIONS
PRINT OPTIONS
PLOT OPTIONS
PRESS <ENTER>
TO SELECT
```

---

**Figure 8-1.** *Output Menu*

To label the output, select Setup Output Headers in the Output Menu or press the Device ID key.

On the output to the printer, plotter, or disk, a menu then appears that lets you specify the device name/serial number, the date, the operator's name, and user comments (Figure 8-2).

DATA OUTPUT HEADERS MODEL ON FILTER DEVICE ID ON 870124 DATE ON 28- JUNE_87 Á OPERATOR ON MIKE COMMENTS	SELECT NAME FILTER_#2— ABCDEFGHIJKLM NOPQRSTUVWXYZ 0123456788-_/# DEL CLEAR DONE  TURN KNOB TO INDICATE CHARACTER OR FUNCTION  PRESS <ENTER> TO SELECT  NUMBERS MAY ALSO BE SELECTED USING KEYPAD
--	---

**Figure 8-2.** Label Menus

Sweep frequencies can be changed with the calibration applied as long as the frequencies are between the calibration start and stop frequencies.

Additionally, a marker sweep can be selected from the Setup Menu. This allows you to sweep between any two active markers as long as the frequency of each falls between the calibrated start and stop frequencies.

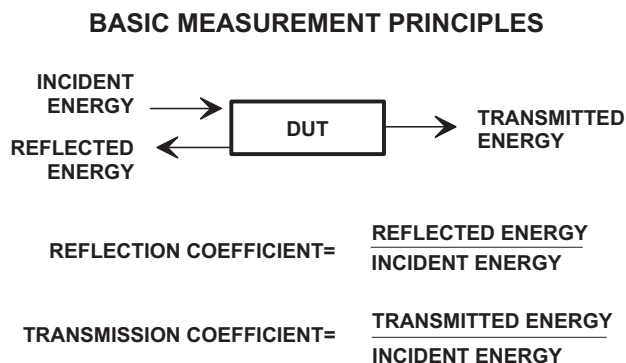
Using the Data Points key, you can select the number of data points for optimal resolution-vs-speed.

Finally, you can enhance the measurement data by reducing the IF bandwidth and using averaging and/or smoothing.

- ❑ Change the IF bandwidth by selecting the Video IF BW key
- ❑ Set the averaging and smoothing values by selecting the Avg/Smooth Menu key
- ❑ Turn on the averaging and smoothing using the Trace Smooth and Average keys, which have LED's to let you know that the enhancement is being applied

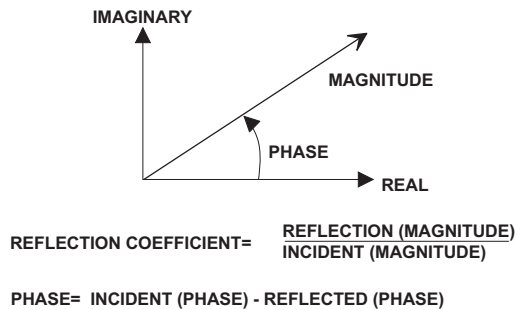
### Measurement Discussion

Before going any further, let us take a few moments to review some basic principles of network measurements. First, we apply incident energy to the input of a test device. If the device's input impedance differs from the measurement system's impedance, some of that energy is reflected. The remainder is transmitted through the device. We call the ratio of reflected-to-incident energy the reflection coefficient. The ratio of transmitted-to-incident energy we call the transmission coefficient (Figure 8-3).



**Figure 8-3.** Basic Measurement Principles

These ratios are complex quantities that have magnitude and phase components. Using vector representation, the vector magnitude is the ratio of reflected-to-incident magnitude (or transmitted-to-incident magnitude), while the vector phase is the difference in phase between the incident energy and the reflected/transmitted energy (Figure 8-4).

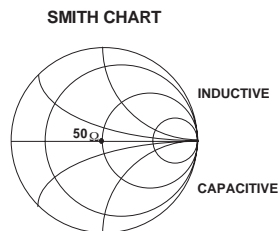


**Figure 8-4.** *Magnitude/Phase Vector*

The measurement reference for the incident energy is the point at which the device connects to the measurement system. We call this point the reference plane. The incident energy at the reference plane is defined as having a magnitude of 1 and a phase of 0 degrees. We establish this during the calibration.

- ❑ The ratio of reflected and transmitted energy to the incident energy can be represented by a number of different measurements and units, as shown below.
- ❑ The default display for reflection measurements is the Smith chart. The default display for transmission measurements is the Log Magnitude and Phase graph.

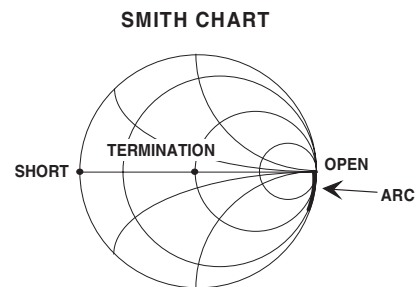
The Smith chart is a convenient way to display device impedance and is a useful aid for the graphical design and analysis of microwave circuits (Figure 8-5).



**Figure 8-5** *Smith Chart Display 1*

Let us assume both that our system is already calibrated and that we have equalized the system for the test port in use. We would then

1. *Connect the Short:* A Short always appears as a dot at the left-most edge of the Smith chart's horizontal axis.
2. *Connect a Termination:* Now you will see another dot located at the center ( $1+j0$ ) of the chart (this assumes a 50-ohm load).
3. *Connect the Open:* An Open appears as an arc on the chart's right edge. This is due to the fringing capacitance of the Open standard (Figure 8-6).



**Figure 8-6.** *Smith Chart Display 2*

Now let's perform a reflection measurement on a 20 dB attenuator over the 1 to 18 GHz range.

We need to determine the setup, calibration, and measurement requirements.

A known good starting point is to reset with Default Program parameters. Since our measurement lies between 1 and 18 GHz, set the Start and Stop frequencies using the Sweep Setup menu that appears on the display following system reset.

Let's perform a simple *Reflection Only* calibration, which uses an open, a short, and a broadband load. To do this, press the Begin Cal key and follow the directions in the menu area.

When you complete the calibration, the "CHANNEL 1 WITH S11" Smith chart appears on the display. Now:

1. Select the Log Magnitude display and install the attenuator.
2. Select Auto Scale to optimize the display data.
3. Use Markers 1 and 2 to find the maximum and minimum impedance.

Now let us perform a transmission measurement on the same 20 dB attenuator over the same frequency range. We will follow the same steps as before, but this time we will use additional features.

Once again, reset the system using the Default Program key.

In this calibration we will select the N-Discrete Frequencies menu option and step all frequencies in increments of 50 MHz.

When the calibration is complete, Channel 1 will display "S21 FORWARD TRANSMISSION WITH LOG MAGNITUDE AND PHASE." You can use Markers 1 and 2 to find the maximum and minimum values of the attenuators insertion loss.

**8-3** LOW LEVEL AND GAIN

This discussion provides methods and techniques for making gain and low-signal-level measurements. It is divided into 37XXXD system considerations and test device considerations.

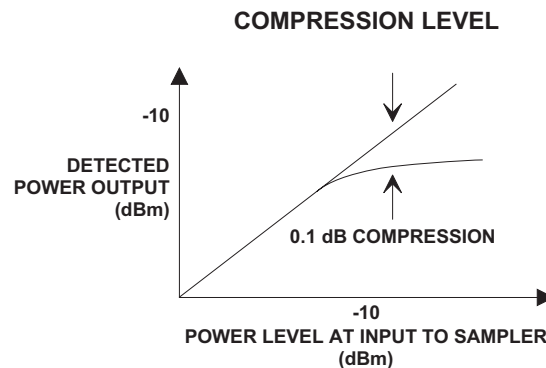
**37XXXD System Considerations**

The 37XXXD system is limited in its ability to test low-signal levels by its dynamic range and signal-to-noise-power ratio. First we will discuss receiver dynamic range, which is the difference between the maximum and minimum acceptable signal levels (Receiver Dynamic Range =  $P_{max} - P_{min}$ ).

**Receiver Dynamic Range**

The dynamic range of the 37XXXD is limited by the 0.1 dB compression level of the samplers at high signal levels. It is further limited at low signal levels by leakage signals and noise.

Figure 8-7 shows the detected output signal as a function of the power level at the sampler. The 0.1 dB compression level is on the order of -10 dBm. The 37XXXD is designed such that all other conversions compress at a much greater level, which leaves the samplers as the main source of nonlinearity.



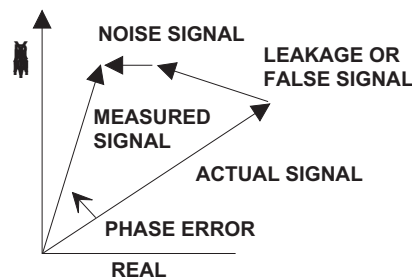
**Figure 8-7.** Compression at 0.1 dB

The small signal response is limited by errors due to noise and leakage signals. The leakage signals are both from within the 37XXXD and at the device-under-test (DUT) connectors.



The detected signal is the vector sum of the desired signals, the noise signals, and the leakage signals. These signals introduce an error or uncertainty (Figure 8-8).

**DETECTED OUTPUT SIGNAL  
UNCERTAINTY**



**Figure 8-8.** Amplitude and Phase Uncertainty

Some of the possible leakage paths for the 37XXXD are the transfer switch, the frequency conversion module, and the DUT. The system limits these leakages to greater than 100 dB. The 12-term error correction can reduce this leakage to better than 110 dB at 18 GHz and 90 dB at 40 GHz.

**NOTE**

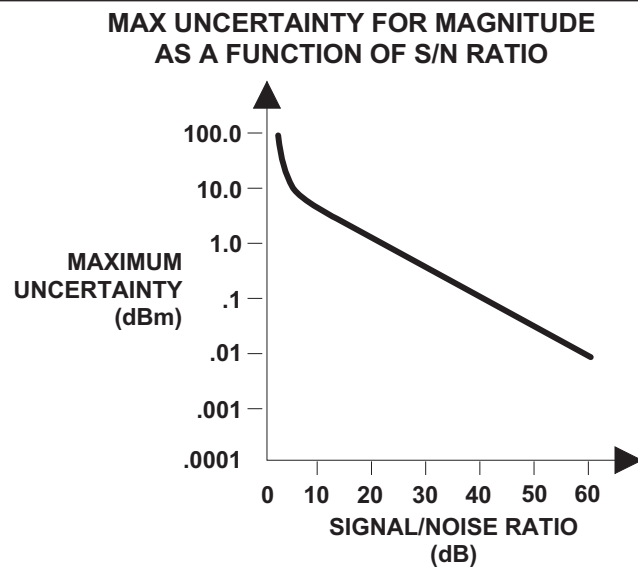
We recommend using an isolation cell to decrease leakage signals for sensitive measurements. For best results, increase the default averaging value and decrease the default IF bandwidth setting during calibration and measurement. Using higher enhancement during the measurement than the calibration will not result in any accuracy improvements.

The DUT connectors should have internally captivated center pins. Those connectors which use external pins to captivate the center conductor should have silver loaded epoxy on the pins to reduce radiation to better than 80 dB.

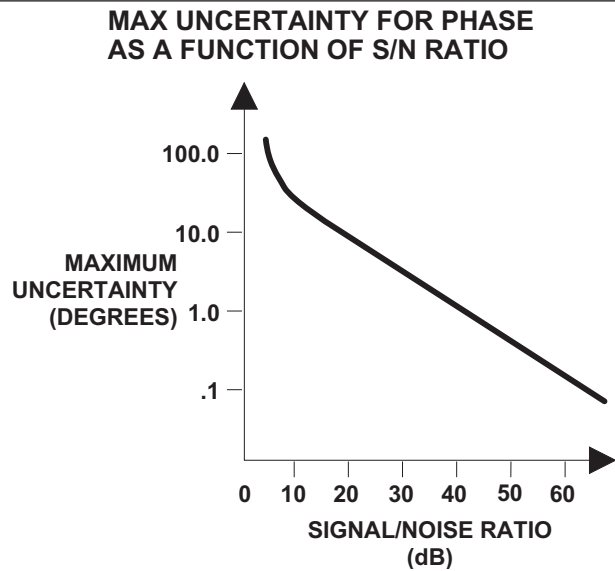
**Signal-to-Noise-Power Ratio**

The signal-to-noise-power ratio for each of the test or reference channels is as shown. The “signal power” is the power level of the 80 kHz IF signal at the internal synchronous detectors, and the “noise power” is the total power contained within the bandwidth of the bandpass filter at 80 kHz.

The uncertainty, or error, in a measurement is a function of the amplitude of leakage signals and of the noise level. The uncertainty in the measurement of magnitude and phase of the S-parameters are calculable and shown in Figures 8-9 and 8-10.

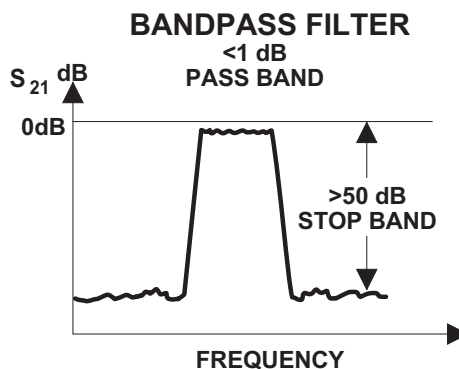


**Figure 8-9.** *The Effect of S/N Ratio On Magnitude Measurements (Noise Only)*



**Figure 8-10.** *The Effect of S/N Ratio On Phase Measurements (Noise Only)*

The most difficult types of measurements are those that exercise the full dynamic range of the 37XXXD, such as filters (Figure 8-11. Filter measurements are examples of where one must observe both low-insertion loss (in the passband) and high attenuation (in the stop band).



**Figure 8-11.** Filter Measurements

There are two techniques that you can use to optimize the signal-to-noise ratio. They are (1) maximizing the RF signal level and (2) using signal enhancement.

To maximize the RF signal level, use the default settings of the 37XXXD.

The 37XXXD provides two enhancements for improving the signal-to-noise ratio: IF bandwidth reduction and averaging.

Reducing the IF bandwidth is a primary method for enhancing accuracy. The 37XXXD has a choice of four bandwidths available from the front panel: Maximum (10 kHz), Normal (1 kHz), Reduced (100 Hz), and Minimum (10 Hz). The noise level should decrease by a factor equal to the square root of the IF bandwidth. Using IF Bandwidth reduction makes for faster measurements than with the use of an equivalent amount of averaging.

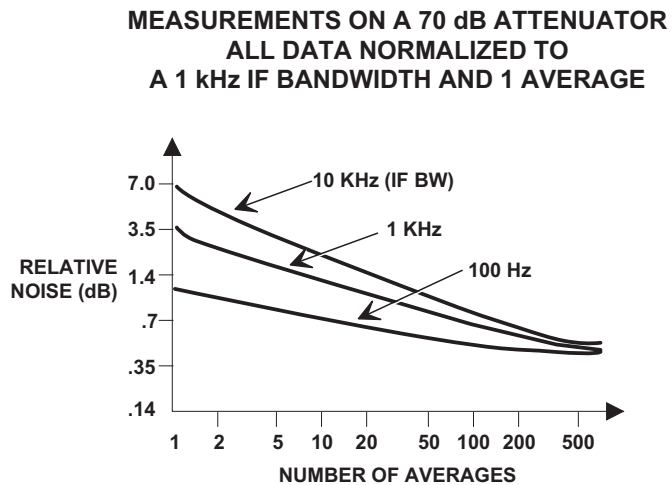
Averaging is another way to improve accuracy. The improvement is proportional to the square root of the number of averages. Two types of averaging are supported: Sweep-by-sweep and point-by-point.

Point-by-point averaging works by collecting multiple measurements while at each frequency point and then averaging them together. Sweep-by-sweep averaging works by performing multiple complete sweeps and averaging the individual the individual frequency points by taking data from the different sweeps. The primary difference is the amount of time between samples at a given frequency point (short for point-by-point, longer for sweep-by-sweep).

Sweep-by-sweep averaging may produce lower trace noise because the averaging time is more likely to exceed the coherence time of the noise source. The disadvantage is that any slow drift or transient response of the device under test will be lost in the averaging process. Sweep-by-sweep is hence less suitable for use during device tuning.

Conversely, point-by-point averaging will better preserve device tuning response or device drift. It may, however, result in slightly elevated trace noise (relative to sweep-by-sweep) since the measurement time may be less than the coherence time of the noise source.

Figure 8-12 shows the measured reduction in noise due to bandwidth and averaging.



**Figure 8-12.** Reduction in Noise Using Averaging

*Example:* Using 1 kHz BW reduction and 10 averages, you would increase the signal-to-noise ratio by 7.6 dB but would lengthen the time required for the measurement by a factor of 4.3. This example assumes a constant signal power.

**Test Device (DUT) Considerations**

In order to test a device, the required input RF level and the expected device output RF level must be determined.

The RF level at Port 1 must be set for the device input RF power level required. Attenuation can be added in steps of 10 dB up to 70 dB using the built-in source attenuator. Amplification can be added by removing the front panel loop and adding an external amplifier.

Before calibration, ensure that the test setup is correct by setting the power level and adding attenuation as needed.

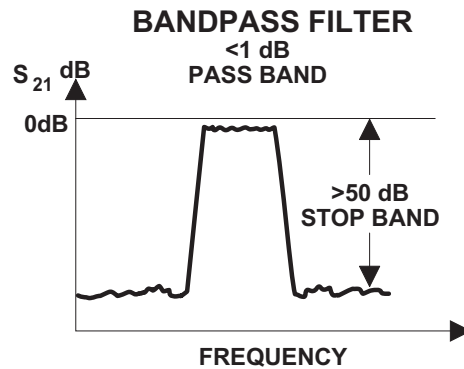
The 37XXXD uses enhancements in the calibration to ensure a wide dynamic range. It automatically selects 1 kHz IF bandwidth and varies the number of averages with the calibration device. Terminations require the most averages.

If desired, the Video IF bandwidth and number of averages can be specified for the calibration measurements. Using 100 averages (Avg = 100) appears to be sufficient for most measurements.

To obtain the maximum performance from the 37XXXD for measurements of attenuation, you can use the capability of the N discrete frequency calibration to spot check measurements in the frequency band of interest.

**Wide Dynamic Range Device - Filter**

Since you do both low-insertion-loss and high-attenuation measurements simultaneously, use the maximum RF signal level and no attenuation. Selecting the 1 kHz Video IF BW setting and 100 averages will likely suffice for this kind of measurement (Figure 8-13).



**Figure 8-13.** Filter Measurements

**High Gain Device - FET**

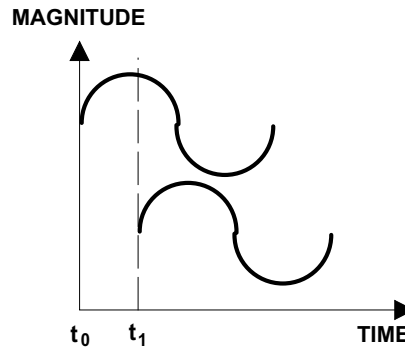
This device has a typical 15 dB gain and requires an input level of about  $-30$  dBm. Set the Port 1 Source Attenuator to 30 dB. Since the device RF output level is  $-15$  dBm ( $-30$  dBm + 15 dB[*gain*] =  $-15$  dBm) no attenuation is needed at Port 2.

**Medium Power Device - Amplifier**

Measure the small signal parameters of a 10 dB gain device that requires an input power level of 0 dBm. Here, Port 1 will have no attenuation. The device RF output level is 10 dBm. This level equals 10 dBm ( $0$  dBm + 10 dB[*gain*] = 10 dBm) into Port 2 and will cause compression in the measurement. At least 10 dB of test attenuation will be needed at Port 2, which will reduce the Port 2 RF level to 0 dB.

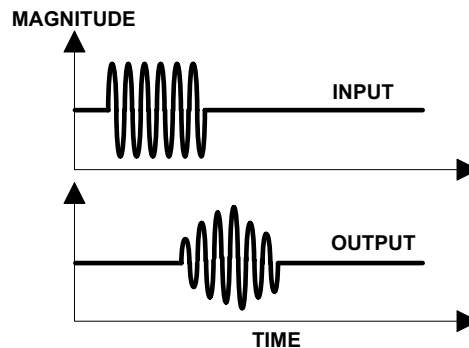
**8-4** GROUP DELAY

Group delay is the measure of transit time through a device at a particular frequency. Ideally, we want to measure a constant—or relatively constant—transit time over frequency. The top waveform shown in Figure 8-14 is measured at one frequency. The bottom waveform is identical to the first, simply delayed in time.



**Figure 8-14.** Two Waveforms Delayed in Time

Referring to Figure 8-15, the first waveform shown is the original waveform. It is made up of many frequency components. After traveling through a device the signal is delayed in time. Some frequencies are delayed more than others and thus our waveform does not have exactly the same shape as before.



**Figure 8-15.** Waveform with Frequency Differences

When delay is nonlinear, as shown above, distortion occurs. By measuring group delay with a network analyzer you can characterize the distortion that occurs from a signal traveling through your test device.



When designing components it is important to measure group delay so that you can compensate for any distortion caused by the component. You may be able to tune the device so as to optimize the performance of group delay over the frequency range of interest. Outside of the specified frequency range, the group delay may or may not be linear.

So how is group delay measured? Signals travel too fast to enable measuring the input and output times of each frequency component. Consequently, we must use mathematical calculations to derive the group delay from the phase slope.

Group delay is mathematically represented by the following equations:

$$\tau = -\frac{d\theta}{d\omega} = \frac{-1}{2\pi} \frac{d\theta}{df} = \frac{-1}{360} \frac{d\theta}{df} = \frac{1}{2\pi} \frac{\Delta\theta}{\Delta f}$$

What this equation shows is that group delay is a measure of the change in phase with relation to the change in frequency.

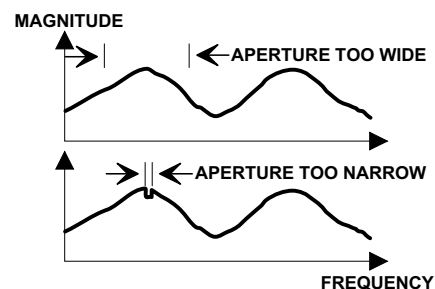
The change in frequency is referred to as an aperture.

$$\Delta f = \text{Aperture}$$

To measure group delay the frequency aperture must be selected. Depending on the size of aperture, different levels of precision can result for the measurement of group delay.

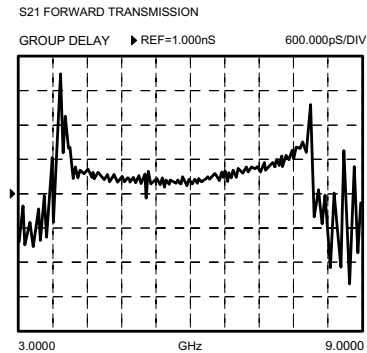
$$\text{Aperture} = \frac{\text{Frequency Range}}{\# \text{ Of Data Points}}$$

A wide aperture results in a loss of fine-grain variations but gives more sensitivity in the measurement of time delay. A small aperture gives better frequency resolution, but at the cost of lost sensitivity. Thus, for any comparison of group delay data you must know the aperture used to make the measurement (Figure 8-16).



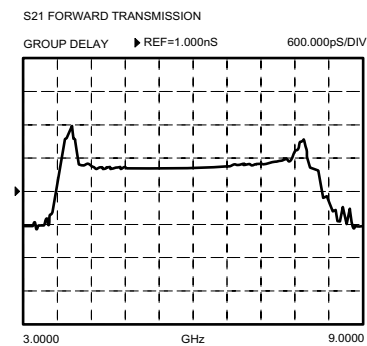
**Figure 8-16.** Waveforms With Aperture Differences

Let us take a look at a group delay measurement made on the Anritsu 37347D Vector Network Analyzer. Group delay, as a measurement option, can be found in the Graph Type menu. After selecting the option, the VNA displays the data in a time-vs-frequency graph, or to be more exact, a group-delay-vs-frequency graph (Figure 8-17).



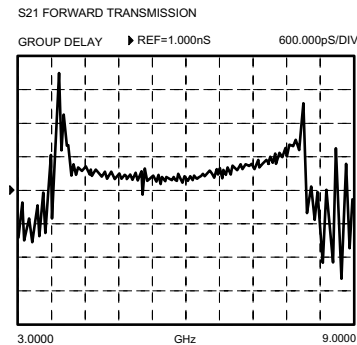
**Figure 8-17.** Group Delay-vs-Frequency Graph

The 37XXXD automatically selects the frequency spacing between data points—that is, the aperture. Notice that this value is displayed on the screen with the measurement (Figure 8-18).



**Figure 8-18.** Group Delay Screen Showing Aperture

The aperture defaults to the smallest setting for the frequency range and number of data points selected. This value is displayed in the Set Scale key menu when measuring group delay (Figure 8-19).



**Figure 8-19.** 37XXXD Aperture

Group delay applications are found throughout the microwave industry, although the majority of such measurements are made in the telecommunications area.

One occurrence of group delay that you may have experienced is with a long-distance telephone call. Occasionally a phone call can be disturbing because of the delay in time from when you speak and when the other person responds. If there is simply a delay, then time delay—or linear group delay—has occurred. But if the voices are also distorted, then non-linear group delay has occurred. It is this distortion that we must avoid. We can avoid linear group delay by measuring group delay both during the design and development stages and during recalibration in the field.

One final group-delay application is found in the development of components. In this application, group delay is measured for the transit time of a signal through the device. When time is of the essence in a fast switching system, as in a modern computer, the travel time through a device is critical.

**8-5** ACTIVE DEVICE

Active devices are key components in microwave systems.

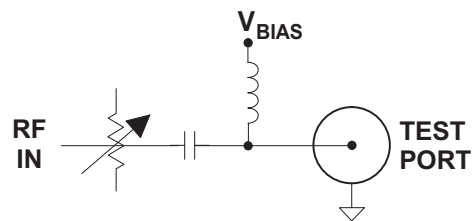
The measurements that are made on active devices are similar to those made on passive devices.

Active devices come in many shapes and sizes. In most cases we are going to have to develop a fixture in which to mount the device.

Active devices require bias voltages, and in many cases they are easily damaged. High gain amplifiers may saturate with input signals of  $-50$  dBm. With active devices, we have a new set of measurement requirements.

The 373XXD has been designed to help you make these types of measurements. It includes one 70 dB step attenuator (60 dB for 37377D and 37397D) used to adjust the Port 1 power level. A second 40 dB step attenuator is also included (with Option 6) in the forward transmission path to allow measurement of high gain devices without sacrificing reverse transmission and reflection measurements ( $S_{12}$ ,  $S_{22}$ ). Bias tees on each port are used to bias the device via the test port center conductor. This approach to bias is useful for testing transistors; however, MMIC's usually require bias injection at other points (Figure 8-20).

### Bias Tees



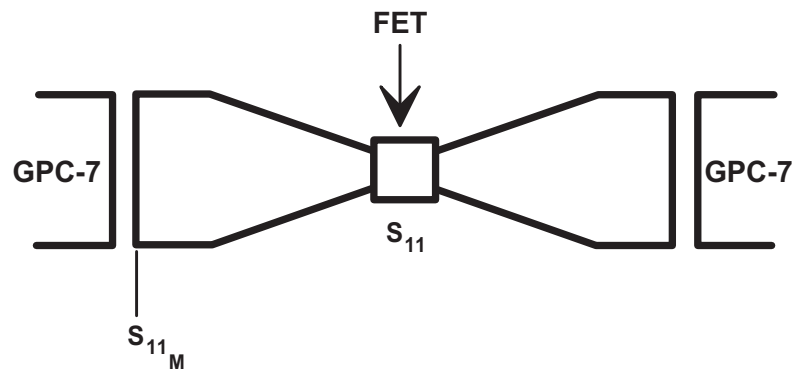
**Figure 8-20.** Bias Tee

Test fixtures are necessary for mounting the device so that it can be measured in our coaxial (or waveguide) measuring system (Figure 8-21).



**Figure 8-21.** Active Device Test Fixture

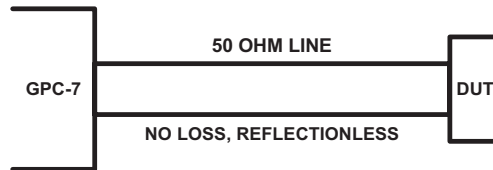
Now we have an interesting situation. While we can measure the performance at the connector—which is the calibration plane—what we really want to know is how our device performs (Figure 8-22).



**Figure 8-22.** View of a Test Device

You can consider the device embedded in the fixture and can measure the S-parameters of the fixture with the device installed.

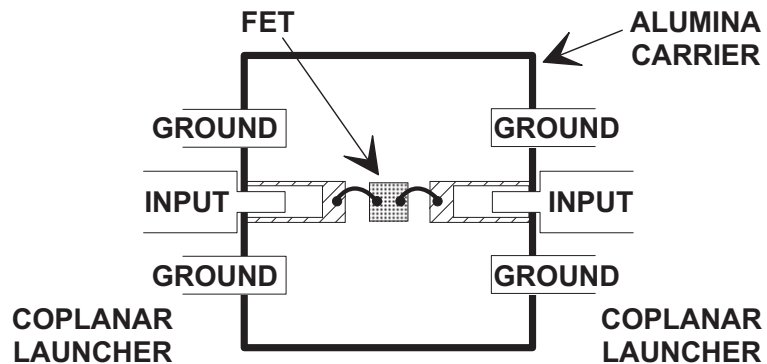
The most elementary situation is a system in which the test fixture is electrically ideal or transparent. In this case, the solution is simple—merely move the reference plane out to the device (Figure 8-23).



**Figure 8-23.** Simple Example of De-Embedding

In some cases—depending on the fixture or the device being measured—this is satisfactory. But when it is not, we need to employ other techniques.

One of the reasons that moving the reference plane out to the device does not always work, is that the test fixture includes a transition from coax to a structure such as microstrip, coplanar waveguide, or stripline (Figure 8-24).



**Figure 8-24.** Coax-to-Substrate Transition

Engineers have come to grips with the general problem. However, there is no established standard approach. Two of the more common approaches are to calibrate the fixture as a part of the analyzer, and to characterize the fixture and compute the desired result.

In the discussion on calibration we saw that the calibration components establish the reference plane and determine the quality of the measurement. If we have a good Open, Short and  $Z_0$  load to place at the end of a microstrip line, we can calibrate the system at the point of measurement.

Figure 8-25 shows some of the special test-fixture calibration standards that are available.

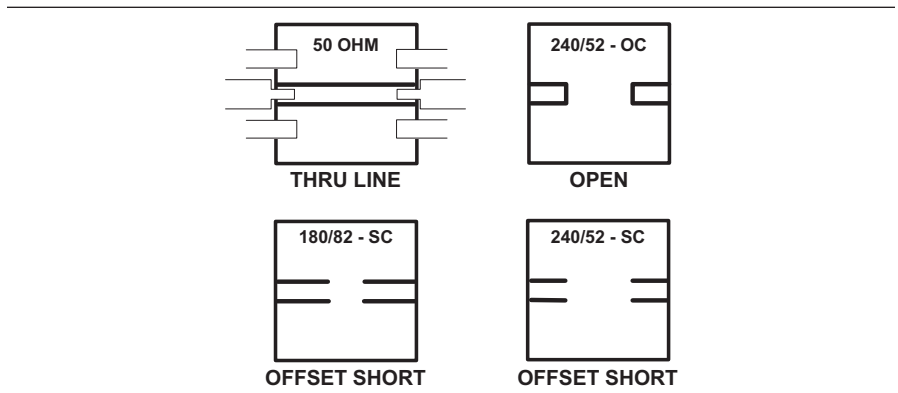


Figure 8-25. Special Test Fixtures

These special calibration kits are far from perfect, but they are superior to our perfect transmission line assumption.

You may also have heard of the probe stations built to permit on-wafer calibration measurements.

The Open, Short, termination approach provides three known standards that permit the analyzer to solve for three unknowns (Figure 8-26).

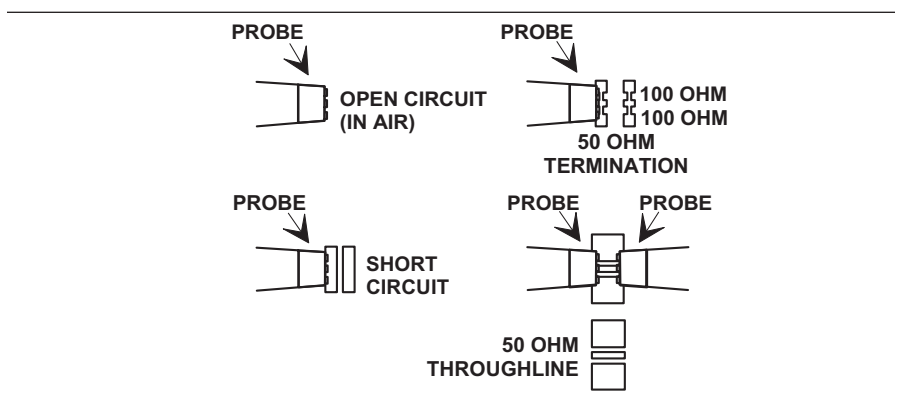


Figure 8-26. Solving for Unknowns

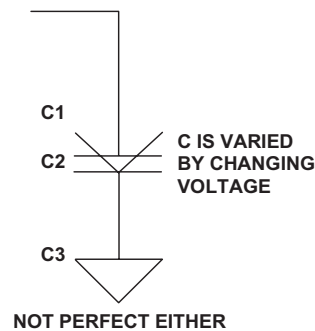
CAUTION 

## CAUTION

You should turn off or disconnect the bias supplies during the calibration, since you are using a Short as the calibration standard.

It is also possible to use three known impedances. For instance, a varactor with three voltages applied (Figure 8-27).

## SPECIAL CALIBRATION KITS



**Figure 8-27.** *Three Known Impedances*

The second approach is to model the fixture. Modeling is elegant but of limited use due to the non-ideal characteristics of the fixture. Modeling can be accomplished in a CAD system.

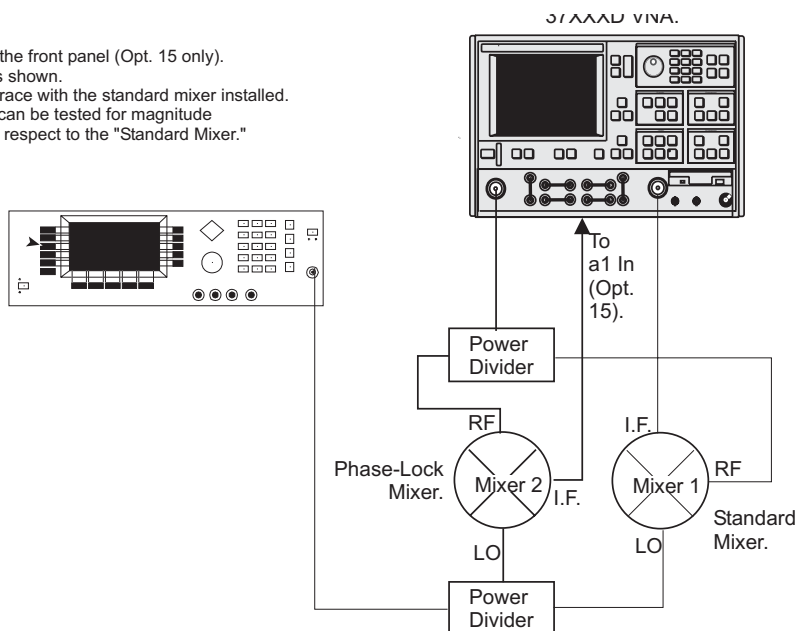
In summary, there are quite a variety of approaches—all with their own characteristic pitfalls. Engineers try to choose the most appropriate technique for their application.



## 8-6 MULTIPLE SOURCE CONTROL

The Multiple Source Control mode permits independent control of the 37XXXD source, receiver, and an external Anritsu synthesizer (67XXB, 68XXXB, MG36XXA/B), without the need of an external controller (Figure 8-28).

1. Remove a1 loop on the front panel (Opt. 15 only).
2. Set up equipment as shown.
3. Normalize the data trace with the standard mixer installed.
4. Subsequent mixers can be tested for magnitude or phase match with respect to the "Standard Mixer."



**Figure 8-28.** Test Setup for Mixer Measurement Using Multiple Source Control Operation

Operation in this mode requires Option 15. Removing the reference loop lets you isolate the receiver from the source. This permits testing of frequency converters such as mixers.

The software lets the frequency ranges and output powers of the two sources be specified. A frequency sweep can comprise up to five separate bands, each with independent source and receiver settings for convenient testing of frequency translation devices such as mixers. Up to five sub-bands (harmonics) can be tested in one sweep.

### Control Formula

Multiple Source control is specified as a displayed frequency range partitioned into from one-to-five consecutive bands. For each band Source 1, Source 2, and receiver frequencies may be interdependently specified per the formula:

$$\text{Source 1} = (1/1) * (F + 0.000000000 \text{ GHz})$$

$$\text{Source 2} = (1/1) * (F + 0.000000000 \text{ GHz})$$

$$\text{Receiver} = (1/1) * (F + 0.000000000 \text{ GHz})$$

where, the multiplier, divisor and frequency offset can be entered specific to the DUT.

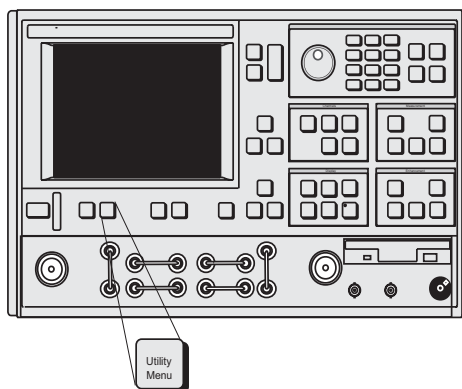
MENU U1
SELECT UTILITY FUNCTION OPTIONS
<b>GPIB ADDRESSES</b>
DISPLAY
INSTRUMENT
STATE PARAMS
GENERAL DISK UTILITIES
CAL COMPONENT UTILITIES
AUTOCAL UTILITIES
COLOR CONFIGURATION
DATA ON(OFF) DRAWING
BLANKING
FREQUENCY INFORMATION
SET DATA/TIME
PRESS <ENTER> TO SELECT OR TURN ON/OFF

**Multiple Source Control Pre-operational Setup**

The two sources receive control information from the 37XXXD VNA. The GPIB address assigned to the external source must be identical to the address contained in the data directed to the source by the 37XXXD VNA. Assure source/VNA address compatibility as follows:

**Step 1.** Install Sources 1 and 2 on the Dedicated GPIB bus.

**Step 2.** Press the Utility Menu key.



**Step 3.** Move cursor to **GPIB ADDRESSES** and press Enter, when menu U1 (left) appears.

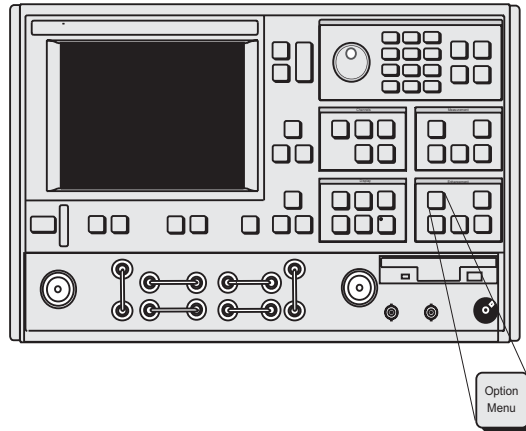
**Step 4.** When menu GP7 (left) appears, observe that the address number is correct. If necessary, use the keypad to enter a new address.

MENU 7
GPIB ADDRESSES
IEEE 488.2 GPIB INTERFACE
ADDRESS 6
DEDICATED GPIB INTERFACE
EXTERNAL SOURCE 1 4
EXTERNAL SOURCE 2 5
PLOTTER 8
POWER METER 23
FREQUENCY COUNTER 7

**Multiple Source Control Operation**

**Step 5.** Press the Option Menu key.

MENU OPTNS
OPTIONS
TRIGGERS
REAR PANEL OUTPUT
DIAGNOSTICS
MULTIPLE SOURCE CONTROL
RECEIVER MODE
SOURCE CONFIG
RF ON/OFF DURING RETRACE
PRESS <ENTER> TO SELECT



**Step 6.** When menu OPTIONS (left) appears, move cursor to **MULTIPLE SOURCE CONTROL** and press the Enter key.

**Step 7.** When menu OM1(left) appears, move cursor to **DEFINE BANDS** and press the Enter key. This brings menu OM 1 to the screen.

MENU OM1
MULTIPLE SOURCE CONTROL
DEFINE BANDS
SOURCE CONFIG
MULTIPLE SOURCE MODE
OFF
STANDBY
ON
MORE
PRESS <ENTER> TO SELECT

MENU OM2
DEFINE BANDS
BAND 1
DISPLAYED FREQ RANGE
BAND START F XXX.XXXXXX XXX GHz
BAND STOP F XXX.XXXXXXXXX GHz
BAND FUNCTIONS
EDIT SYSTEM EQUATIONS
STORE BAND 1 BANDS STORED: ( 1 2 3 4 5 )
CLEAR ALL DEFINITIONS
SET MULTIPLE SOURCE MODE
PRESS <ENTER> TO SELECT

**Step 8.**

Coincident with menu OM2 (left), the data display area of the screen presents a chart entitled "RANGES OF BANDS STORED." This chart shows the band start and band stop frequencies that have been stored for each of five bands.

Using menu OM2, the displayed frequency range can be divided into one to five bands.

Band 1 must start at the beginning of the frequency range and end at either the user-specified stop frequency or the end of the frequency range.

Band 2 must begin at the next point after band 1 ends and end at either the user-specified stop frequency or the end of the frequency range.

**Step 9.**

Move cursor to **BAND**; select **BAND 1** by entering "1" using the keypad or rotary knob.

**Step 10.**

Move cursor to **BAND START F**, and use keypad or rotary knob to enter the band 1 start frequency.

**Step 11.**

Move cursor to **BAND STOP F**, and enter the band 1 stop frequency.

**Step 12.**

Move cursor to **EDIT SYSTEM EQUATIONS** and press the Enter key.

**Step 13.**

When menu OM3 (left) appears, select **SOURCE 1**.

**Step 14.**

Move cursor to **MULTIPLIER** and use keypad or rotary knob to enter desired multiplier for Source 1. This is the multiplier term in the following equation:

$$Freq = (Multiplier/Divisor) X (F + Offset Frequency)$$

**Step 15.**

Move cursor to **DIVISOR** and use keypad or rotary knob to enter desired **DIVISOR** for source 1. This is the divisor term given in the above equation.

**Step 16.**

Move cursor to either **OFFSET FREQUENCY**, and use keypad or rotary knob to enter desired offset frequency for Source 1; or **C.W.**, and press Enter to toggle C.W. to OFF.

The Offset Frequency choice is the offset frequency given in the above equation. The C.W. choice removes F from the equation and places Source 1 in the CW mode.

MENU OM3
EDIT SYSTEM EQUATIONS
EQUATION TO EDIT
SOURCE 1
SOURCE 2
RECEIVER
EQUATION SUMMARY
C.W. OFF
MULTIPLIER XX
DIVISOR XX
OFFSET FREQ XXX.XXXXXXXXX GHz
PREVIOUS MENU
PRESS <ENTER> TO SELECT

<b>MENU OM2</b>
DEFINE BANDS
<b>BAND 2</b>
DISPLAYED FREQ RANGE
BAND START F XX.XXXXXX GHz
BAND STOP F XX.XXXXXX GHz
BAND FUNCTIONS
EDIT SYSTEM EQUATIONS
<b>STORE BAND 1</b>
BANDS STORED: ( NONE )
CLEAR ALL DEFINITIONS
SET MULTIPLE SOURCE STATE
PRESS <ENTER> TO SELECT

- Step 17.** Move the cursor to **PREVIOUS MENU** and press the Enter key. This returns you to menu OM2 (left).
- Step 18.** Move cursor to **STORE BAND 1** and press the Enter key. This stores the band start frequency, the band stop frequency and the Source 1, Source 2 and Receiver equations.
- Step 19.** Note that the **BAND** number has incremented to 2.
- Step 20.** Repeat the above steps to define the start and stop frequencies for bands 2 through 5. Set up the system equations for each band.

**NOTE**

Except for band 1, the system software constrains all start frequencies to follow the previous band's stop frequency. However, while frequency bands are being defined or the system equations are being edited, the system is automatically placed in the standby mode. In this mode, frequencies that may be entered are not supervised by the system software; any frequency can be entered and displayed. When the mode is switched to **ON** (in menu OM1, left), the system software restricts the frequencies to band limits. When the mode is switched to **OFF**, the frequencies are restricted to system limits.

<b>MENU OM1</b>
MULTIPLE SOURCE CONTROL
<b>DEFINE BANDS</b>
SOURCE CONFIG
MULTIPLE SOURCE MODE
OFF
STANDBY
ON
MORE
PRESS <ENTER> TO SELECT

**Source Lock Polarity: Normal/Reverse**

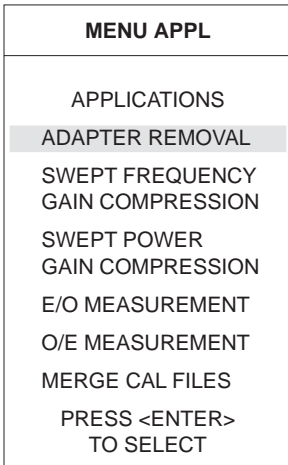
When making frequency translated devices measurements using the Multiple Source Control mode, enter the RF (source 1) and LO (source 2) frequencies. If the LO frequency is lower than the RF frequency, no phase inversion is expected by the VNA. The opposite is true if the LO frequency is higher than the RF frequency. These determinations may be wrong if the DUT is a cascaded multiple conversion device. In that case, determine if the final phase polarity is inverse of what is assumed by the VNA, and set the Source Lock Polarity to Reverse. Failure to do so may cause the RF source to be erroneously locked at a 5 MHz offset.

**8-7 ADAPTER REMOVAL**

Using adapters in VNA measurement applications can introduce complex errors that add to measurement uncertainty. The VNA Adapter Removal procedure provides for adapter compensation. This on-screen, menu-driven procedure allows the use of a through-line device or adapter with different connector types (non-insertables) on either end to be used for measurement calibration. The electrical effects are subsequently compensated for. The Adapter Removal procedure is described below.

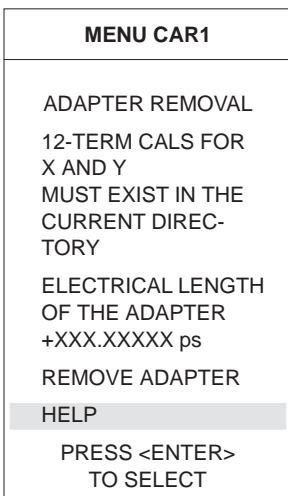
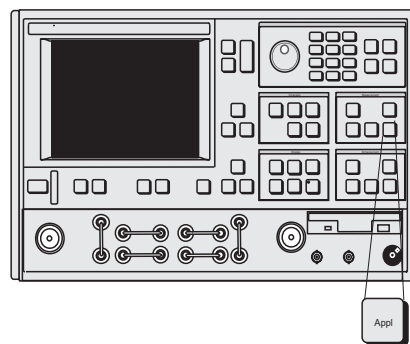
**NOTE**

For purposes of explanation, assume that the adapter to be used is a length of rigid coax with a type N male connector on one end and an SMA male connector on the other end. Further assume that the Test Port 1 connector is a type N female and that the Test Port 2 connector is an SMA female (below).



**Procedure:**

**Step 1.** Press the Appl key (below) to display the APPLICATIONS menu (top left).



**Step 2.** Move the cursor to **ADAPTER REMOVAL** and press the Enter key.

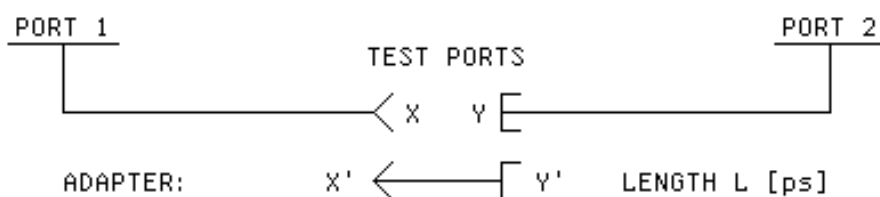
**Step 3.** Select **HELP** in the next menu (bottom left) to produce the step-by-step procedure shown in Figure 8-29 (next page).

**Step 4.**

Follow the on-line procedure and connect the Adapter's N male connector (X) to the N female connector on the VNA's Test Port 1.

## - ADAPTER REMOVAL -

THE ADAPTER REMOVAL APPLICATION PERMITS THE USER TO ACCURATELY MEASURE NON-INSERTABLE DEVICES. THE PROCESS INVOLVES USING AN ADAPTER OF KNOWN ELECTRICAL LENGTH AND PERFORMING TWO FULL 12-TERM CALIBRATIONS.



X AND Y ARE COAXIAL OR WAVEGUIDE CONNECTOR TYPES.  
L IS THE LENGTH OF THE ADAPTER [ps].

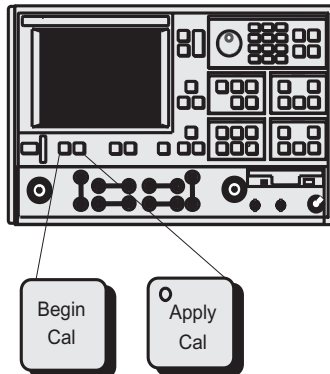
## - INSTRUCTIONS -

1. CONNECT ADAPTER TO PORT 1. PERFORM A FULL 12-TERM CALIBRATION USING Y' AND Y AS THE TEST PORTS AND STORE CALIBRATION TO DISK (e.g. YPRIME\_Y.CAL).
2. CONNECT ADAPTER TO PORT 2. PERFORM A FULL 12-TERM CALIBRATION USING X AND X' AS THE TEST PORTS AND STORE CALIBRATION TO DISK (e.g. X-XPIME.CAL).
3. BOTH X AND Y CAL FILES MUST BE PLACED IN THE CURRENT DIRECTORY OF THE HARD OR FLOPPY DISK.
4. ENTER THE ELECTRICAL LENGTH OF THE ADAPTER.
5. SELECT <REMOVE ADAPTER> TO READ THE X AND Y CAL FILES AND CALCULATE THE NEW SET OF 12-TERM ERROR COEFFICIENTS. IF DESIRED, SAVE RESULTS.

**Figure 8-29.** Adapter Removal Help Screen

MENU SR1
SAVE/RECALL FRONT PANEL AND CAL DATA
SAVE
RECALL
SET UP OUTPUT HEADERS
PRESS <ENTER> TO SELECT FUNCTION

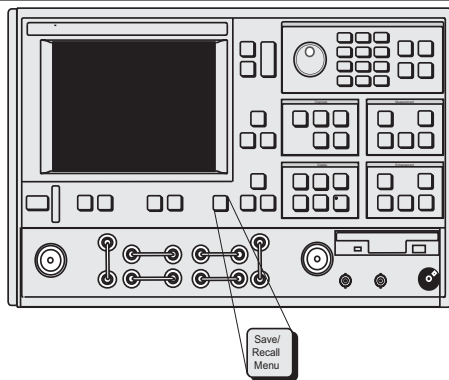
**Step 5.** Press the Begin Cal key (below).



**Step 6.** Follow the menu prompts and choose to perform a full 12-term calibration. Use the Adapter's SMA male connector (Y) as Test Port 1 and the VNA's Test Port 2 connector as Test Port Y (Figure 8-27).

MENU SR2
SAVE
FRONT PANEL SETUP IN INTERNAL MEMORY
FRONT PANEL SETUP AND CAL DATA ON HARD DISK
FRONT PANEL SETUP AND CAL DATA ON FLOPPY DISK
PRESS <ENTER> TO SELECT

**Step 7.** Press the Save/Recall Menu key (below).



**Step 8.** Choose **SAVE** from the displayed menu (top left).

**Step 9.** Choose the appropriate hard or floppy disk location, based on individual preference (Menu SR2, bottom left).

**Step 10.** When prompted, select CREATE NEW FILE and enter a conventional DOS filename, such as YP-RIME\_Y.CAL. (Store this file in the current directory.)

**Step 11.** Now connect the Adapter's SMA male end to the VNA's Test Port 2 SMA female connector.



MENU CAR1

ADAPTER REMOVAL  
12-TERM CALS FOR  
X AND Y  
MUST EXIST IN THE  
CURRENT DIREC-  
TORY

ELECTRICAL LENGTH  
OF THE ADAPTER  
**+170.0000 ps**

REMOVE ADAPTER

HELP

PRESS <ENTER>  
TO SELECT

**Step 12.**

Press the Begin Cal key again.

**Step 13.**

Follow the menu prompts; again choose to perform a full 12-term calibration. Now use the Adapter's Type N male connector (X') as Test Port 2. Use the VNA's Test Port 1 connector as Test Port X.

**Step 14.**

Save the calibration as described in Steps 7 and 8, above. Give this file a unique filename, such as X\_XPRIME.CAL. (Store this file in the current directory.)

**Step 15.**

Press the Appl key and chose **ADAPTER REMOVAL** to return to Menu CAR1 (top left).

**Step 16.**

Enter the electrical length of the Adapter (170 ps for the test adapter) in the appropriate place in Menu CAR1.

**NOTE**

Electrical length does not have to be precise. Plus or minus 5 ps is adequate for this procedure.

MENU CAR2

ADAPTER REMOVAL  
READ CAL FILE OF  
THE X TEST PORT  
FROM HARD DISK  
(ADAPTER ON  
PORT 2)

READ CAL FILE OF  
THE X TEST PORT  
FROM FLOPPY DISK  
(ADAPTER ON  
PORT 2)

PRESS <ENTER>  
TO SELECT

PRESS <CLEAR>  
TO ABORT

**Step 17.**

Move the cursor to **REMOVE ADAPTER**, and press the Enter key.

**Step 18.**

Move the cursor to the appropriate **READ CAL FILE OF THE X TEST PORT . . .**, depending on where the calibration data is stored (hard or floppy disk). Press the Enter key.

**NOTE**

At this juncture, the "X" calibration file is marked for reading, but not actually read. Both the "X" and "Y" files will be read into the VNA together in the next step.

## MENU CAR3

ADAPTER REMOVAL  
 READ CAL FILE OF  
 THE Y TEST PORT  
 FROM HARD DISK  
 (ADAPTER ON  
 PORT 2)

READ CAL FILE OF  
 THE Y TEST PORT  
 FROM FLOPPY DISK  
 (ADAPTER ON  
 PORT 2)

PRESS <ENTER>  
 TO SELECT

PRESS <CLEAR>  
 TO ABORT

**Step 19.**

Move the cursor to the appropriate **READ CAL FILE OF THE Y TEST PORT...** choice (top left) and press the Enter key.

**Step 20.**

Observe that the text **READING... FROM DISK** appears in the menu area.

**Step 21.**

When the file has finished reading, the procedure is complete and the program returns to the **SWEEP SETUP** menu (below).

If the adapter is still connected, the display will show the S-parameters of the adapter. Any device to be measured with that same connector configuration will be measured in an absolute sense.

Also, you may wish to store the resulting Adapter Removal calibration for later use.

## MENU SU1

## SWEEP SETUP

START  
 XX.XXXXXXXXXX GHz

STOP  
 XX.XXXXXXXXXX GHz

SET CENTER/SPAN  
 XXX DATA POINT(S)  
 XX.XXXXXXXXXX GHz  
 STEP SIZE

C.W. MODE ON (OFF)  
 XX.XXXXXXXXXX GHz

MARKER SWEEP

DISCRETE FILL

HOLD BUTTON  
 FUNCTION

TEST SIGNALS

PRESS <ENTER>  
 TO SELECT  
 OR TURN/OFF

## 8-8 GAIN COMPRESSION

There are a number of ways to measure Gain Compression. With a VNA two approaches are possible: Swept Frequency Gain Compression (SFGC) and Swept Power Gain Compression (SPGC). The 37XXXD offers a very straightforward approach to each of these measurements.

It is normally desirable to make S-parameter measurements in the linear operating region of an amplifier and then observe Compression or amplitude-modulation/phase-modulation (AM/PM) characteristics by increasing the input power to drive the amplifier into its nonlinear region. The characteristics of the amplifier-under-test (AUT) dictate the operating power levels required for the tests. Prior to making measurements on a specific amplifier the user must determine the desired operating levels. A recommended level for linear region operation is:

$$P = PG - \text{Gain} - 15\text{dB} \quad (PG = \text{Nominal } 1 \text{ dB compression of the AUT})$$

The actual level is constrained by the power available from the VNA and the built in 70 dB step attenuator. (In the case of the 37XXXD, available power is easily supplemented by the addition of an external amplifier/attenuator combination.) Power input to Port 2 must also be considered as the test should not drive the VNA into nonlinear operation. Typical specifications show 0.1dB compression at a VNA receiver input level of -10 dBm. The receiver signal is derived through a 13 dB coupler from the Port 2 signal. The 37XXXD also includes a 40 dB step attenuator in this path that enables linear operation with input signals as high as 30 dBm (1 watt), the maximum signal level that should be input to Port 2. Higher power levels can be measured by attenuating the signal prior to Port 2.

A typical power configuration example that will also be used throughout this section is included in Figure 8-28. A 10 dB pad has been used at both Port 1 and Port 2 to minimize mismatch errors.

### ***Power and VNAs***

It is necessary to measure absolute power to determine Gain Compression. VNA receiver channels are typically down-converters and do not measure power directly. They are, however, linear so that an accurate power calibration at one level will result in a receiver channel that will accurately indicate power in dBm.

The 37XXXD firmware supports calibration with the following power meters: Anritsu ML2430A, HP437B, HP438, and Gigatronics 8541C/8542C. These meters differ in the way they handle sensor efficiency (consult the power meter manual), and the 37XXXD does expect to receive corrected data from the power meter.

**Gain Compression Power Configuration**

**Amplifier Specifications:**

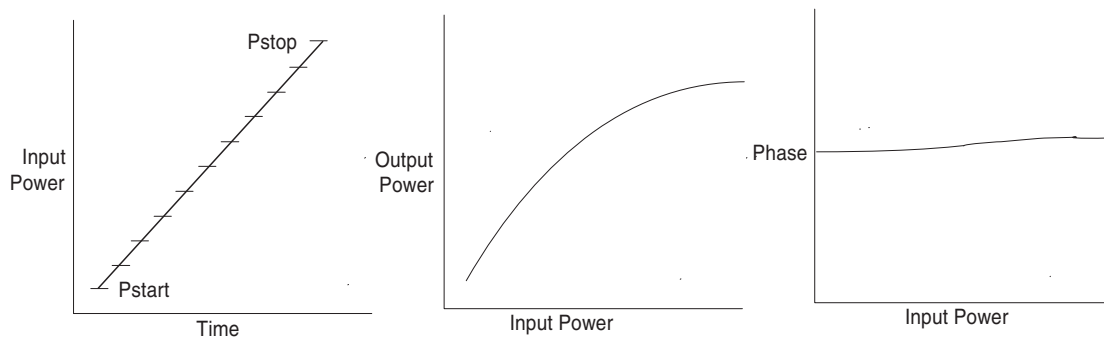
Frequency Range:	8 to 12 GHz
Gain	25 dB nominal
1 dB Gain Compression (GC)	12 dBm minimum

Gain Compression Formula:  $P = 12 - 25 - 15 = -28 \text{ dBm}$

**37369C Setup**

Default Power:	-7 dBm
Power Control:	-8 dB
Port 1 Attenuator:	0 dB
External Port 1 Attenuator:	10 dB
The above setting result in	
Port 1 Power:	-25 dBm
Maximum Amplifier Output	≈15 dBm
Coupler Loss:	≈13 dB
Port 2 Attenuator:	10 dB

**Figure 8-28.** Gain Compression Measurement Plan (Example)



**Figure 8-29.** Power In ( $P_i$ ) versus Power Out ( $P_o$ ) Graphical Example

Errors can result if the proper correction factor is not applied by the power meter, as shown below.

Correction Factor (%)	Error (dB)
1	0.043
3	0.128
5	0.212
10	0.414

It is desirable to set the power control at or near the minimum (this varies from -20 to -30 dB, depending upon model) when establishing P, as this provides the full ALC range for a power sweep.

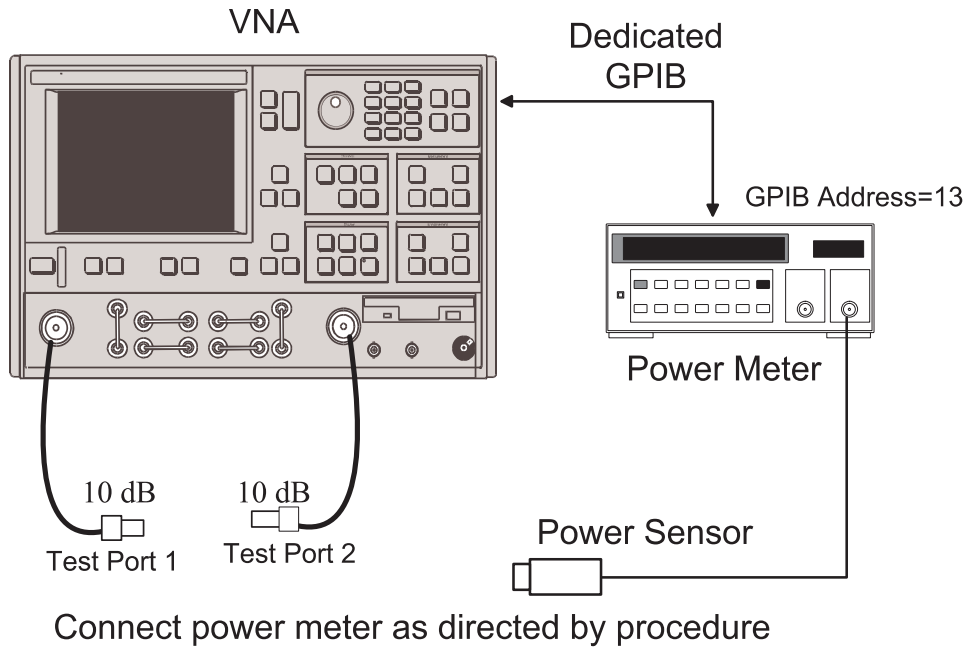
The vector error correction available in VNAs is dependent upon ratioed S-parameter measurements. Power is measured using a single, unratioed channel; therefore, when power is being measured error correction is turned off.

#### ***Swept Power Gain Compression***

A swept power test is done at a CW frequency. The input power will be increased with a step sweep starting at  $P_{start}$  and ending at  $P_{stop}$ . The step increment is also user defined. This lets you observe the conventional  $P_o$  vs.  $P_i$  presentation or a display of *Phase* vs.  $P_i$ . Figure 8-29 (previous page) illustrates this process. The SPGC process is implemented in the 37XXXD by following the procedure that begins on page 8-43. The test setup required for this procedure is shown in Figure 8-30 (page 8-42).

#### ***Swept Frequency Gain Compression***

This is a manual procedure that provides a normalized amplifier response as a function of frequency at  $P_{start}$  and manually increases the input power while observing the decrease in gain as the amplifier goes into compression. This lets you easily observe the most critical compression frequency of a broadband amplifier. The SFGC process is implemented in the 37XXXD by following the procedure that begins on page 8-52. The test setup required for this procedure is shown in Figure 8-30 (following page).



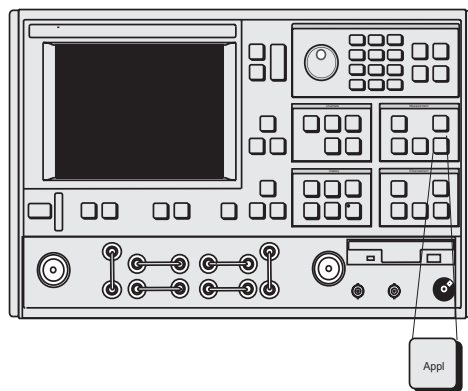
**Figure 8-30.** Test Setup for Gain Compression Measurements

**Swept Power Gain Compression Measurement**

The following procedures describes the Swept Power Gain Compression Measurement.

**Step 1.** Press the Appl key.

MENU APPL
ADAPTER REMOVAL
SWEPT FREQUENCY
GAIN COMPRESSION
<b>SWEPT POWER</b>
<b>GAIN COMPRESSION</b>
E/O MEASUREMENTS
O/E MEASUREMENTS
MERGE CAL FILES
PRESS <ENTER>
TO SELECT



**NOTE**

A 12-Term S-parameter calibration is not necessary for gain compression calibration and measurement. If such a calibration is in place, it will be disabled during the gain compression operation.

MENU GC2
SWEPT POWER
GAIN COMPRESSION
SET FREQUENCIES
P START
-25.00 dBm
P STOP
-5.00 dBm
STEP SIZE
1.00 dB
ATTENUATION
GAIN COMPRESSION
POINT (MAX REF)
1.00 dB
NOMINAL OFFSET
0.00 dB
MORE
PRESS <ENTER>
TO SELECT

**Step 2.** Move cursor to **SWEPT POWER GAIN COMPRESSION** and press Enter, when menu Appl (top left) appears.

**Step 3.** When menu GC2 (bottom left) appears, follow the directions that appear adjacent to the menu, as described below:

Move cursor to **SET FREQUENCIES**, press Enter and select from 1 to 10 frequencies.

*Enter the frequency value, press a terminator key (e.g. GHz/10<sup>3</sup>/μs/m), then Enter to add the frequency to the list.*

**NOTE**

The number of frequencies and step size, that is entered later, directly affect the time required for Linear Power Calibration, in a later step.

**MENU GC\_DF2**

SWEPT POWER  
FREQUENCIES  
INPUT A FREQ,  
PRESS <ENTER>  
TO INSERT  
SWEPT POWER  
FREQUENCY  
12.000000000 GHz  
CLEAR FREQ NUMBER  
1  
CLEAR ALL  
FINISHED, RETURN TO  
POWER SWEEP SETUP  
PRESS <ENTER>  
TO SELECT

**MENU GC\_DF2**

SWEPT POWER  
GAIN COMPRESSION  
PORT 1 ATTN  
0\*10 dB (0 - 70)  
PORT 2 ATTN  
2\*10 dB (0 - 40)  
PREVIOUS MENU  
PRESS <ENTER>  
TO SELECT

Move cursor to **FINISHED, RETURN TO POWER SWEEP SETUP** and press Enter.

Move cursor to **P START** (previous page), set per power plan (Figure 8-28), and press Enter.

Move cursor to **P STOP** (previous page), set per power plan, and press Enter.

Move cursor to **STEP SIZE** (previous page), enter a value, and press Enter.

*The 1 dB default value is reasonable. This value, along with the number of frequencies entered in a previous step, directly affect the time required for Linear Power Calibration, in a later step.*

Move cursor to **ATTENUATION** (previous page) and press Enter. Set power values (bottom left) per power plan. Move cursor to **PREVIOUS MENU** and press Enter when finished.

Move cursor to **GAIN COMPRESSION** (previous page), enter the desired value (1 dB is typical), and press Enter.

Move cursor to **NOMINAL OFFSET** (previous page), enter the value of any external device(s) connected between the front panel Input and Output connectors. Press Enter when done. In the example use -10 dB.

*A setting of 0.00 dB is normal when no external devices are connected.*

Move cursor to **MORE** (previous page) and press Enter to proceed to the next menu (GC3) (next page).



MENU GC3
SWEPT POWER GAIN COMPRESSION
CALIBRATE FOR LINEARITY ([NO] CAL EXIST)
LINEARITY ON [OFF] CORRECTION
CALIBRATE RECEIVER ([NO] CAL EXISTS)
S21 OPTIONS ([NOT] STORED)
AUT TEST TYPES
GAIN COMPRESSION
AM/PM
MULTIPLE FREQ GAIN COMPRESSION
RETURN TO SWEPT FREQUENCY MODE
PREVIOUS MENU

**Step 4.**

Move the cursor to **CALIBRATE FOR LINEARITY**, press Enter, and follow the instructions that (1) appear adjacent to the follow-on menu and (2) are described below.

*If a calibration already exists, the menu choice will indicate CAL EXIST in blue letters.*

**NOTE**

This step is not required for a successful gain compression measurement; however, linearizing the power from Port 1 (which is what this step does) provides increased accuracy.

Prepare the power meter as described in the following instructions:

- a. Preset, zero, and calibrate the power meter.
- b. Set power meter offset, if required.
- c. Connect the power meter to the dedicated GPIB interface and the power sensor to the test port.
- d. Select <START LINEAR POWER CALIBRATION>.

Connect the power sensor to Test Port 1.

With **START LINEAR POWER CALIBRATION** highlighted (bottom left), press Enter to begin the calibration.

**Step 5.**

Observe **LINEARITY CORRECTION** choice (top left). If a linearity correction has been performed, it will indicate ON in blue letters.

**Step 6.**

Move cursor to **CALIBRATE RECEIVER** and follow the instructions, as follows:

Connect a through line between Test Port 1 and Test Port 2. Be sure to include all components that are part of the measurement path.

MENU GC_SU8A
CALIBRATE FOR LINEAR POWER
FORWARD DIRECTION ONLY
START LINEAR POWER CALIBRATION
PREVIOUS MENU
PRESS <ENTER> TO SELECT

MENU GC3
SWEPT POWER GAIN COMPRESSION
CALIBRATE FOR LINEARITY ([NO] CAL EXIST)
LINEARITY ON [OFF] CORRECTION
CALIBRATE RECEIVER ([NO] CAL EXISTS)
S21 OPTIONS ([NOT] STORED)
AUT TEST TYPES
GAIN COMPRESSION
AM/PM
MULTIPLE FREQ GAIN COMPRESSION
RETURN TO SWEPT FREQUENCY MODE
PREVIOUS MENU

**Step 7.**

Wait until one complete sweep has completed, then press Enter to store the calibration.

**NOTE**

It is likely that the trace will be off screen at the bottom of the display. If so, press Autoscale to obtain a discernable trace. If this trace shows vertical instability, then do the following:

1. Press Video IF BW and select **REDUCED (100 Hz)** from the menu.

2. Press Avg/Smooth Menu and select **AVERAGING 100 MEAS. PER POINT** from the menu.

3. Press Average to turn averaging on.

Press Appl to return to the gain compression menu set, and follow the prompts to return to Menu GC3. Repeat Step 6.

**Step 8.**

Move the cursor to **S21 OPTIONS** (top left), select **NORMALIZE S21** in the next menu (not shown), then **NORMALIZE S21** again (bottom left); then press Enter and follow the menu instructions:

Remove the through line and connect the amplifier-under-test (AUT) between Port 1 and Port 2.

Apply bias to the AUT.

Wait until one complete sweep has completed, then press Enter to store the normalization measurement.

**Step 9.**

Move the cursor to the desired test and press Enter. The steps that follow presume that gain compression has been selected.

MENU GC_NORM
NORMALIZE S21
CONNECT AUT AND APPLY BIAS .
WAIT FOR ONE COMPLETE SWEEP BEFORE STORING
PRESS <ENTER> TO STORE
PRESS <CLEAR> TO ABORT

**MENU SU3A**

SWEPT POWER SETUP

SWEPT POWER FREQUENCY  
9.00000000 GHz

P START  
-25.00 dBm

P STOP  
-5.00 dBm

STEP SIZE  
1.00 dB

POWER SWEEP ON

HOLD BUTTON FUNCTION

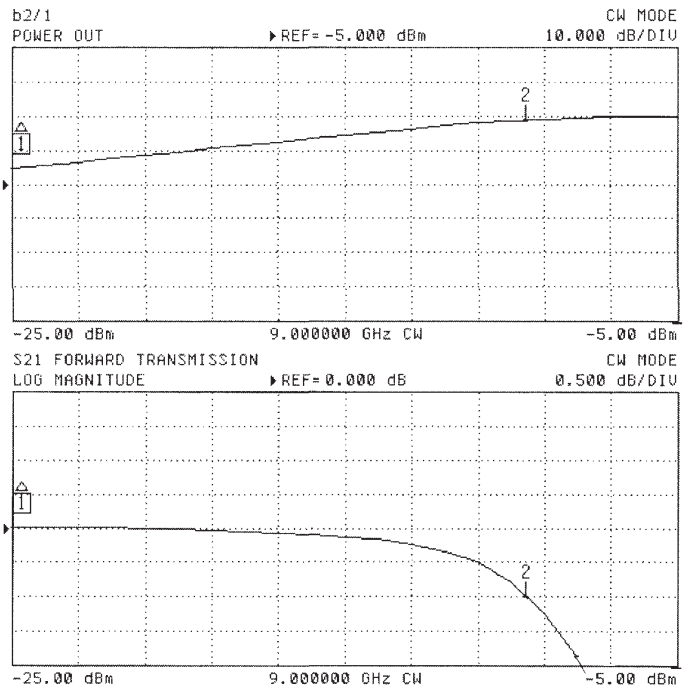
MULTIPLE FREQ GAIN COMPRESSION

RETURN TO SWEPT FREQUENCY MODE

PRESS <ENTER> TO SELECT OR TURN ON/OFF

**Step 10.**

Observe that the SWEPT POWER SETUP menu and the dual-trace display resembles that shown below.



**MENU M7**

SEARCH

VALUE  
-1.000dB

REFERENCE  
MAXIMUM VALUE  
ΔREF MARKER  
0 dB

VALUE AT REFERENCE  
-0.000 dB

SEARCH LEFT  
SEARCH RIGHT  
-9.56 dBm

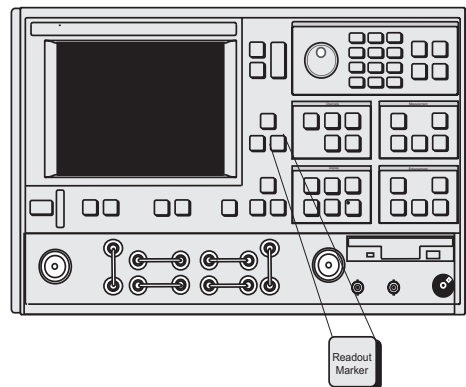
SEARCH MRKR VALUES  
**CH1: 13.753dBm**  
CH2:  
CH3: -1.000 dB  
CH4:

TRACKING ON

MARKER READOUT FUNCTIONS

**Step 11.**

Press Readout Marker (below) for a display of gain compression at the marker frequency.

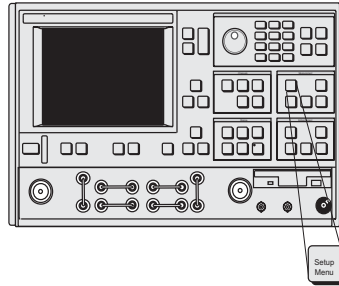


**Step 12.**

Observe the readout marker values from the displayed menu (left).

MENU SU3A
SWEPT POWER SETUP
SWEPT POWER FREQUENCY 9.00000000 GHz
P START -25.00 dBm
P STOP -5.00 dBm
STEP SIZE 1.00 dB
POWER SWEEP ON
HOLD BUTTON FUNCTION
MULTIPLE FREQ GAIN COMPRESSION
RETURN TO SWEPT FREQUENCY MODE PRESS <ENTER> TO SELECT OR TURN ON/OFF

**Step 13.** Press Setup Menu (below) to return to SWEPT POWER SETUP menu.



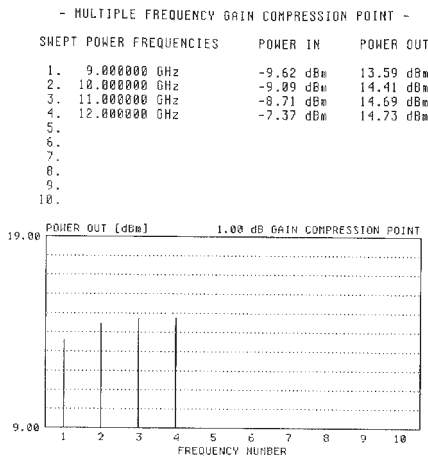
**Step 14.** Move cursor to **SWEPT POWER FREQUENCY** (top left), select the next frequency from the SET FREQUENCY list, and press Enter.

**Step 15.** Repeat Steps 11 through 13.

**Step 16.** Repeat Steps 14 and 15 until all frequencies have been observed.

**Step 17.** To examine the phase performance for a swept input power, **AM/PM** should be selected. This leads to the two channel display (Channels 2 and 4) with Channel 4 active shown below. The sweep mode is continuous to facilitate tuning, Markers are set to the  $\Delta$ Reference mode on the active channel.

MENU
CH2 - 21
REFERENCE PLANE 0.0000mm
MARKER 1 -25.00 dBm
MARKER TO MAX
MARKER TO MIN
$\Delta(1-2)$ -15.44 dBm 4.17°
MARKER READOUT FUNCTIONS



<b>MENU GC4</b>
MULTIPLE FREQUENCY GAIN COMPRESSION
TEST AUT
TEXT DATA TO HARD DISK
TEXT DATA TO FLOPPY DISK
SWEPT POWER GAIN COMPRESSION
RETURN TO SWEPT FREQUENCY MODE
PRESS <ENTER> TO SELECT

**Step 18.**

Repeat Steps 13 through 16 until all desired frequencies have been observed.

**Step 19.**

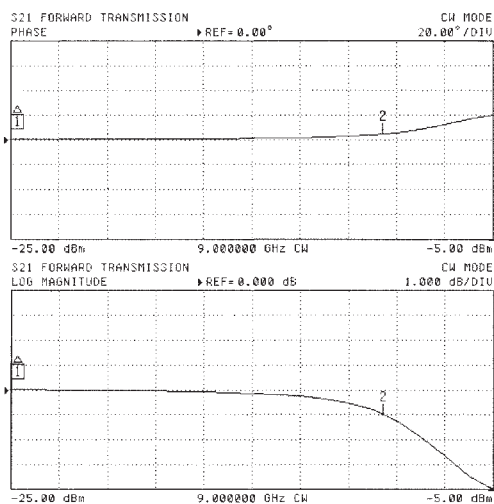
If desired, a multiple frequency gain compression display can be obtained by selecting **MULTIPLE FREQUENCY GAIN COMPRESSION** (left) and pressing Enter.

**Step 20.**

Move cursor to **TEST AUT** (top left) and press Enter.

**Step 21.**

Observe that the Multiple Frequency Gain Compression display resembles that shown below.



**Step 22.**

Make desired selection from menu to copy text and data to hard or floppy disk (top left).

**Step 23.**

The power linearity calibration, receiver calibration, and DUT normalized data exists in volatile memory. At this time, the data can be stored for subsequent recall using the SAVE function.

**NOTE**

It is prudent to save this calibration; otherwise, it will be destroyed if you move anywhere in the program except between this calibration and the S-parameters menu.

**Step 24.** Move cursor to **RETURN TO SWEEP FREQUENCY MODE** and press Enter to exit the gain compression mode.

**NOTE**

When exiting the Swept Frequency Power Gain Compression mode, the DUT should be turned off, unless the user has selected the proper attenuator settings for standard swept frequency (S-parameter) operation.

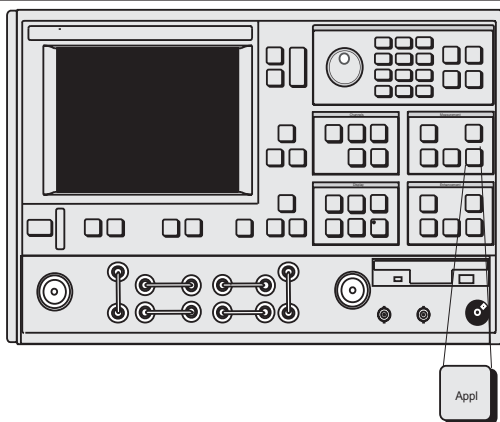
**Swept Frequency Gain Compression Measurement**

The following procedure describes the Swept Frequency Gain Compression Measurement.

*Preliminary:* Refer to Figure 8-28 and set the Power Control and Port 1 Attenuator for the values shown in the power plan for the example, or in the power plan constructed for measurement of a test device. These power plan values should also be used in the S-parameter calibration that may be performed using the Begin Cal key and menus.

MENU APPL
ADAPTER REMOVAL
SWEPT FREQUENCY GAIN COMPRESSION
SWEPT POWER GAIN COMPRESSION
E/O MEASUREMENTS
O/E MEASUREMENTS
MERGE CAL FILES
PRESS <ENTER> TO SELECT

**Step 1.** Press the Appl key.



MENU GC3
SWEPT FREQUENCY GAIN COMPRESSION
NOMINAL OFFSET 0.00 dB
CALIBRATE FOR FLATNESS (NO CAL EXISTS)
FLATNESS OFF CORRECTION
CALIBRATE RECEIVER (NO CAL EXISTS)
NORMALIZE S21 (NOT STORED)
GAIN COMPRESSION POINT (0 dB REF) 1.00 dB
TEST AUT
EXIT APPLICATION

**Step 2.** Move cursor to **SWEPT FREQUENCY GAIN COMPRESSION** and press Enter, when menu APPL (top left) appears.

**Step 3.** When menu GC3 (bottom left) appears, follow the directions that appear adjacent to the menu, as described below:

Move the cursor to **NOMINAL OFFSET**, enter the value of any external device(s) connected between the front panel Input and Output connectors. Press the Enter key when done.

Optionally, move the cursor to **CALIBRATE FOR FLATNESS**, press Enter and follow the instruction menu as described on the following page.

If a calibration already exists, the menu choice will indicate CAL EXIST in blue letters.

**NOTE**

This step is not required for a successful gain compression measurement; however, calibrating the power from Port 1 (which is what this step does) provides increased accuracy.

Prepare the power meter as described in the following instructions:

- a. Preset, zero, and calibrate the power meter.
- b. Set power meter offset, if required.
- c. Connect the power meter to the dedicated GPIB interface and the power sensor to the test port.
- d. Select <START LINEAR POWER CALIBRATION>.

Connect the power sensor to Port 1.

Set the number of power calibration points.

If, in a previous menu, data points had been set to 401 points, entering 8 provides 50 power points (every 8th point); entering 4 provides 100 power point (every 4th point)s, and entering 1 provides 401 power points. The VNA interpolates between power calibration frequencies.

Enter a POWER TARGET value.

Make this value the same as resulting Port 1 power value shown in Figure 8-28 (page 8-40). -25 dBm for the example.

With **START FLAT POWER CALIBRATION** highlighted (bottom left), press Enter to begin the calibration.

**NOTE**

When the above calibration finishes, the source power will have been accurately calibrated. In the next step, this power calibration will be transferred via the through line to the receiver.

MENU GC_SU8A
CALIBRATE FOR FLAT PORT POWER
FORWARD DIRECTION ONLY
101 POINTS MEASURE 1 PWR POINT EVERY 1 POINT(S)
POWER TARGET -25.00 dBm
<b>START FLAT POWER CALIBRATION</b>
PREVIOUS MENU
PRESS <ENTER> TO SELECT
TURN KNOW TO CHANGE NUMBER OF POINTS



MENU GC1
SWEPT FREQUENCY GAIN COMPRESSION
NOMINAL OFFSET -10.00 dB
CALIBRATE FOR FLATNESS (JCAL EXISTS)
FLATNESS CORRECTION AT -25.00 dBm
CALIBRATE RECEIVER (CAL EXISTS)
NORMALIZE S21 ([NOT]STORED)
GAIN COMPRESSION POINT (0 dB REF) 1.00 dB
TEST AUT
EXIT APPLICATION

**Step 4.**

Move cursor to **CALIBRATE RECEIVER** and follow the instructions, as follows:

Connect a through line between Test Port 1 and Test Port 2. Be sure to include all components that are part of the measurement path.

Wait until one complete sweep has completed, then press Enter to store the calibration.

**NOTE**

It is likely that the trace will be off screen at the bottom of the display. If so, press Autoscale to obtain a discernable trace. If this trace shows vertical instability,

- Press Video IF BW and select **REDUCED (100 Hz)** from the menu
- Press Avg/Smooth Menu and select **AV-ERAGING 100 MEAS. PER POINT** from the menu
- Press Average to turn averaging on

**Step 5.**

Press Appl to return to the gain compression menu, and follow the prompts to return to Menu GC1. Repeat Step 4.

**Step 6.**

Move the cursor to **NORMALIZE S21** (top left), press Enter, and follow the menu instructions (bottom left):

Remove the through line and connect the amplifier-under-test (AUT) between Port 1 and Port 2.

Apply bias to the AUT.

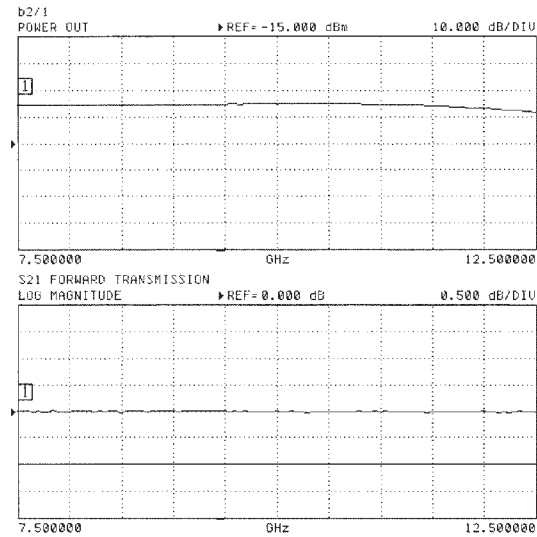
Wait until one complete sweep has completed, then press Enter to store the normalization measurement.

**Step 7.**

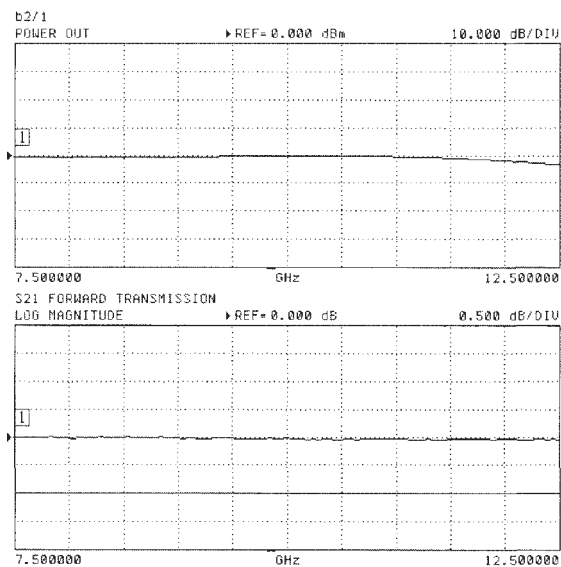
Move the cursor to **TEST AUT** (top left) and press Enter.

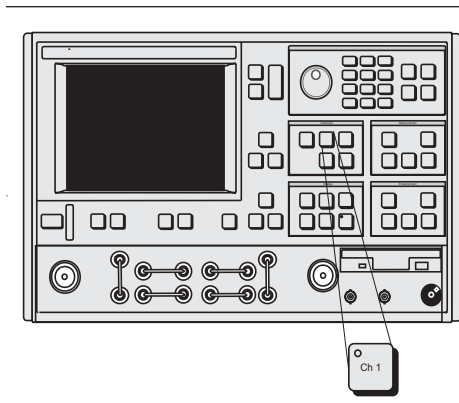
MENU GC_SU8A
RECEIVER CALIBRATION
CONNECT THROUGHLINE BETWEEN TEST PORTS
INCLUDE ANY COMPONENTS WHICH ARE PART OF THE MEASUREMENT PATH
WAIT FOR ONE COMPLETE SWEEP BEFORE STORING
PRESS <ENTER> TO STORE
PRESS <CLEAR> TO ABORT

**Step 8.** Observe that the dual-trace display resembles that shown below.



**Step 9.** Note that the top display (Channel 1), shows the power out from the AUT. For the example test device, the nominal output power is about 0 dBm with the input at -25 dBm. To better evaluate this device, turn on markers and set the Channel 1 reference to 0 dB, as shown below.



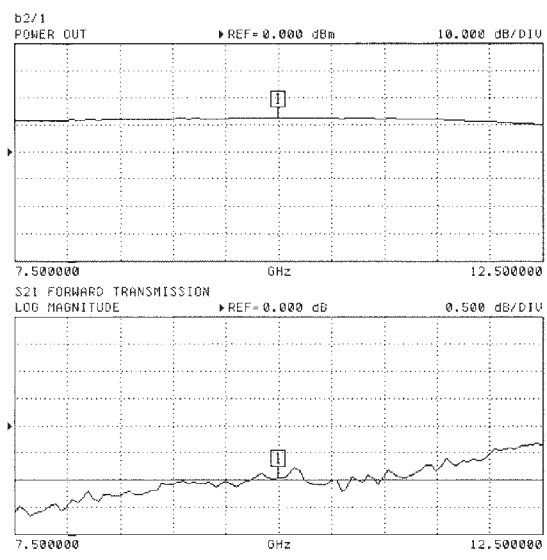
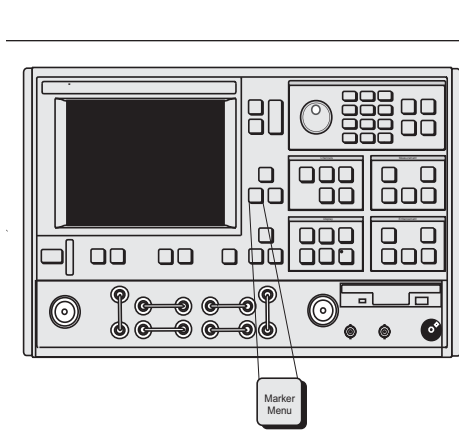


**Step 10.**

Press the Ch1 key (top left) to make channel 1 active.

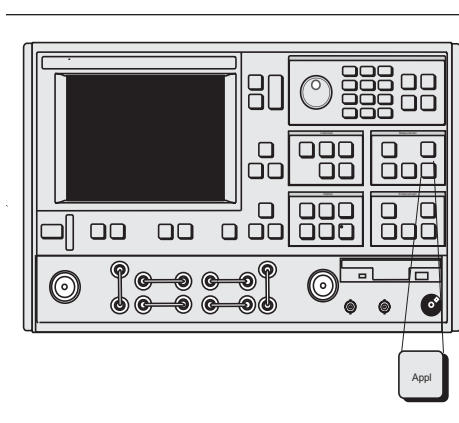
**Step 11.**

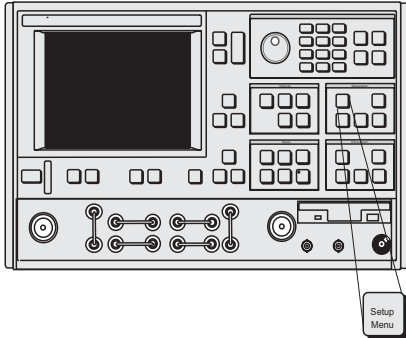
Press the Marker Menu key (middle left), turn on marker 1, and position it to a desired point on the trace (below). (Press the Readout Marker key for frequency and amplitude information.)



**Step 12.**

Press the Appl key to return to the TEST SIGNALS menu (Menu SU2, next page).





**Step 13.**

Press the Setup Menu key (top left), select **POWER CONTROL** (bottom left) and increase the value while observing compression in channel 3 (S<sub>21</sub>).

**NOTE**

The rotary knob or the keypad can be used to set the POWER CONTROL value. In using the rotary knob, the displayed value does not change in real time with movement of the control. Change occurs after the rotation of the knob is complete.

**Step 14.**

Press the Marker Menu key again, and observe the displayed Ch 3 trace and the marker values from the displayed menu (below).

MENU SU2
TEST SIGNALS
POWER CONTROL 5.47 dB 0 TO -20.00 dB
PORT 1 ATTN 0 * 10 dB (0 - 70)
PORT 1 POWER -1.53 dBm
PORT 2 ATTN 0 * 10 dB (0 -40)
CALIBRATE FOR FLATNESS (CAL EXISTS)
FLATNESS CORRECTION AT -11.53 dBm
PORT 2 POWER 0.00 dBm
EXIT APPLICATION PRESS <ENTER> TO SELECT OR TURN ON/OFF

MENU SU2
MARKER 1 ALL DISPLAYED CHANNELS
CH 1 - S11 USER 10.000000 GHz 12.06 dBm
CH 2 - S12
CH 3 - S21 10.000000 GHz -0.992 dB
CH 4 - S21
MARKER TO MAX MARKER TO MIN
MARKER READOUT FUNCTIONS
PRESS <ENTER> TO SELECT

**Step 15.**

The power linearity calibration, receiver calibration, and DUT normalized data exists in volatile memory. At this time, the data can be stored for subsequent recall using the SAVE function.

**NOTE**

It is prudent to save this calibration; otherwise, it will be destroyed if you move anywhere in the program except between this calibration and the S-parameters menu.

MENU SU2
TEST SIGNALS
POWER CONTROL 5.47 dB 0 TO -20.00 dB
PORT 1 ATTN 0 * 10 dB (0 - 70)
PORT 1 POWER -1.53 dBm
PORT 2 ATTN 0 * 10 dB (0 -40)
CALIBRATE FOR FLATNESS (CAL EXISTS)
FLATNESS CORRECTION AT -11.53 dBm
PORT 2 POWER 0.00 dBm
<b>EXIT APPLICATION</b>
PRESS <ENTER> TO SELECT OR TURN ON/OFF

**Step 16.**

Move cursor to **RETURN TO SWEPT FREQUENCY MODE** and press Enter to exit the gain compression mode.

**Step 17.**

Press the Appl key to return to the TEST SIGNALS menu (left), highlight **EXIT APPLICATION** and press Enter to exit the gain compression measurement area.

**CAUTION**

When exiting the Swept Frequency Power Gain Compression mode, the DUT should be turned off, unless the user has selected the proper attenuator settings for standard swept frequency (S-parameter) operation.

**8-9** RECEIVER MODE

The Receiver Mode provides three distinct modes of operation:

- Sweep/Source Lock mode, phase locks the internal source
- Synthesizer/Tracking mode, lets the receiver track a 67XXB, 68XXB, or 69XXA synthesizer
- Set-On mode, lets the VNA operate as a tuned receiver

**Source Lock Mode**

The Source Lock mode enables the 37XXD to phase lock to its internal source.

**Tracking Mode**

In the Tracking Mode, the 37XXD steers its second local oscillator frequency and phase signal so as to phase-lock itself to the reference signal. Typically the source is a synthesizer, since it must be accurate to better than  $\pm 10$  MHz for the 37XXD to achieve lock. Due to the inherent resolution of the 37XXD, frequency resolution is limited to 1 kHz intervals. If Option 3 is installed frequency resolution is limited to 1 Hz.

For receive frequencies outside the indicated test set range, the use of external mixers and a synthesizer is required. Dual Source Control is required in this case.

**Set-on Mode**

In the Set-On mode, the source lock circuitry of the 37XXD is completely by-passed. Reference signals are no longer necessary for system operation. This allows all of the 37XXD samplers to operate over their full dynamic range. As a result, the source and the 37XXD must be locked to the same 10 MHz time base, otherwise coherent detection is not possible. Only synthesized sources may be used in this mode. Dual source control is required.

Due to the inherent resolution of the 37XXD local oscillators, frequency resolution is limited to 1 kHz intervals over the frequency range of the VNA. If Option 3 is installed, frequency resolution is limited to 1 Hz.

**Receiver Mode Block Diagram**

The block diagram shown in Figure 8-31 shows how the system is configured for all of the possible modes of operation. With the switches set as shown, the system operates in the Set-On mode. LO1 and LO2 are pre-set to allow only a prescribed signal to be detected by the synchronous detector. With the switch in SOURCE LOCK position the system is operating in the internal source-lock mode. With the switch in the TRACKING position, the system is in the synthesizer tracking mode.

**Receiver Mode Menus**

The menus associated with the Receiver Mode are described in the alphabetical listing (Appendix A) under their call sign: RCV1, RCV2, RCV3, etc.

**Procedure, Receiver Mode Operation**

A detailed procedure for operation using the Receiver Mode option is provided in the following pages.

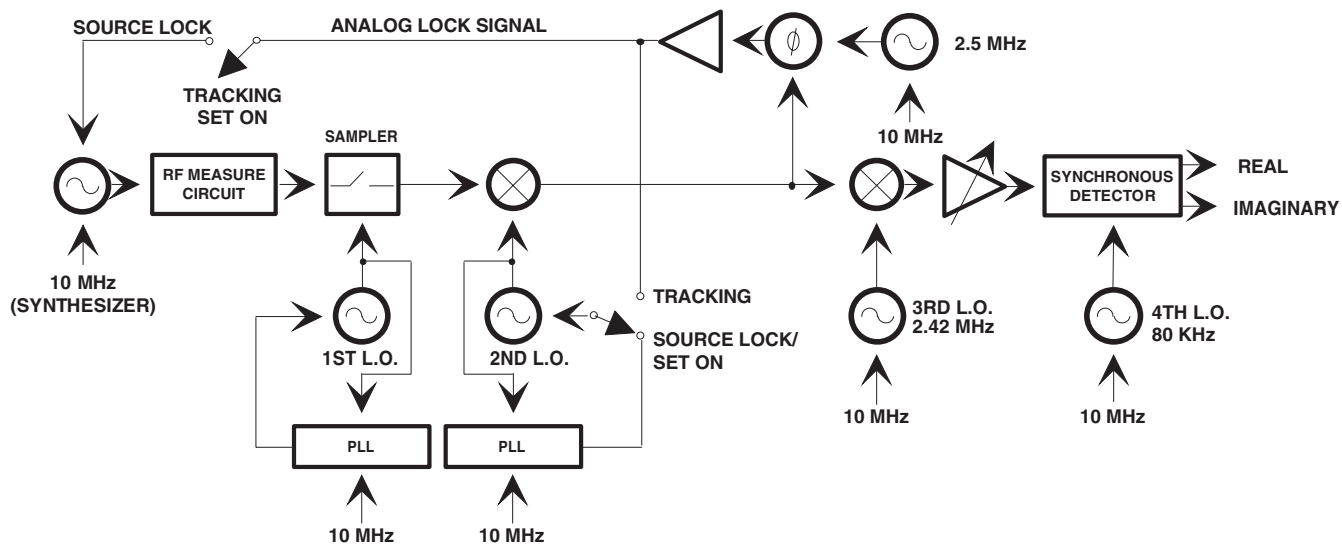


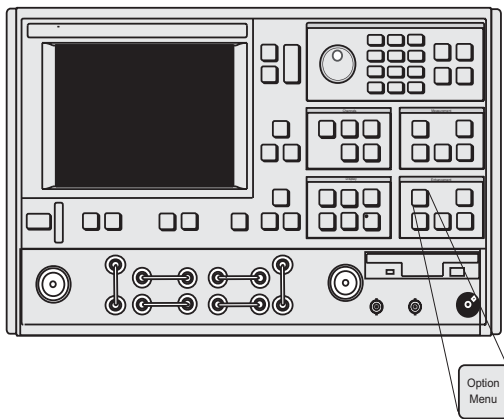
Figure 8-31. 37XXXD Phase Lock Modes

MENU OPTNS	
OPTIONS	
TRIGGERS	
REAR PANEL OUTPUT	
DIAGNOSTICS	
MULTIPLE SOURCE CONTROL	
RECEIVER MODE	
SOURCE CONFIG	
RF	ON/OFF
DURING RETRACE	
PRESS <ENTER> TO SELECT	

**Operating Procedure, Receiver Mode**

The three operational modes that comprise the Receiver Mode can be set up as follows:

**Step 1.** Press the Option Menu key (below).



MENU RCV1	
RECEIVER MODE	
STANDARD	
USER DEFINED	
SOURCE CONFIG	
SPUR REDUCTION NORMAL/OFF	
PRESS <ENTER> TO SELECT	

**Step 2.** When menu OPTNS (top left) appears, select **RECEIVER MODE**.

**Step 3.** When menu RCV1 (middle left) appears, select either **STANDARD** (Step 4) or **USER DEFINED** (Step 5). Your selection depends on the application.

**Step 4.** The Standard mode uses the Source Lock mode for operation with the internal source. The user has no control over selections within the Standard Mode.

Because entering the standard mode from the User Defined Mode erases the current stored calibration data, a warning menu (RCV3, bottom left) appears when **STANDARD** is selected. Press Enter to enter into the Standard mode or press Clear to abort.

MENU RCV3	
STANDARD RECEIVER MODE	
WARNING:	
CONTINUING MAY INVALIDATE CURRENT SETUP AND CALIBRATION	
PRESS <ENTER> TO CONTINUE	
PRESS <CLEAR> TO ABORT	

**NOTE**

*Spur Reduction: Normal/OFF:* Spur Reduction Off may be selected when making non-ratioed measurements or using the Set-On Receiver mode. Under those measurement conditions, it may reduce high level noise. In normal S-parameter measurement mode, Spur Reduction should remain "Normal," as the noise level is not affected.



**Step 5.**

Selecting **USER DEFINED RECEIVER MODE** in menu RCV1 brings menu RCV 2 to the screen. When menu RCV 2 appears, the last mode selected is highlighted in red. The default selection is **SOURCE LOCK**.

Source Lock, Tracking or Set-On modes can be selected from this menu. When a mode is selected, information about that mode is displayed on the screen. This information describes the mode and the capabilities required of the RF source.

---

MENU RCV1
RECEIVER MODE
STANDARD
<b>USER DEFINED</b>
SOURCE CONFIG
SPUR REDUCTION NORMAL/OFF
PRESS <ENTER> TO SELECT

---

---

MENU RCV2
USER DEFINED RECEIVER MODE
<b>SOURCE LOCK</b>
TRACKING
SET ON
PRESS ENTER TO SELECT

---

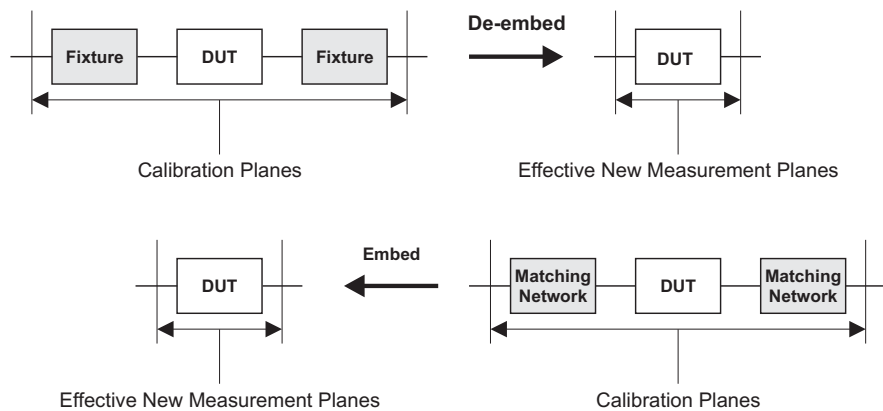
---

MENU RCV4
USER DEFINED RECEIVER MODE
WARNING:
CONTINUING MAY INVALIDATE CURRENT SETUP AND CALIBRATION
PRESS <ENTER> TO CONTINUE
PRESS <CLEAR> TO ABORT

---

**8-10** EMBEDDING/  
DE-EMBEDDING

In many S-parameter measurements, the measurement of the DUT may also include other set-up components that affect the overall measurement result. For example, there may be a test fixture required between the normal coaxial calibration planes and the DUT. It may be useful to see the DUT performance with a certain matching network in place or it may be desired to see what the subsystem performance would be when the given DUT is inserted, etc. The classical purposes of embedding and de-embedding are shown in Figure 8-32, below.



**Figure 8-32.** Classic Embedding and De-embedding

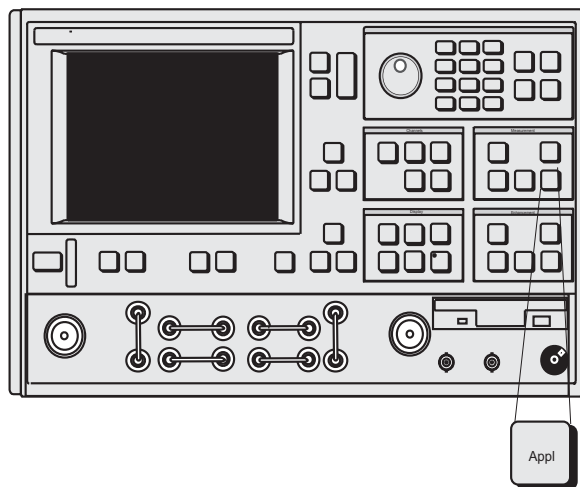
One way of handling these chores within the instrument itself is through embedding and de-embedding: the process of mathematically adding or subtracting networks to or from the measured result. This feature is available in all 37XXXD VNAs as shown in the following paragraphs.

**Embedding**

Embedding of Matching Networks, or other components, can be done as follows:

**MENU DE8**  
 EMBED/DE-EMBED  
 S2P FILE  
 PORT 1/PORT 2  
 METHOD  
 EMBED/DE-EMBED  
 SWAP PORTS OFF  
 OF S2P DATA  
 APPLY NETWORK  
 S2P FILE DATA TO  
 CAL FILE DATA  
 PRESS <ENTER>  
 TO SELECT  
 OR CHANGE

**Step 1.** Press the APPL menu key on the instrument's front panel.



**MENU DE9**  
 EMBED/DE-EMBED  
 S2P FILE  
 ORIGINAL CAL FILE  
 TO APPLY NETWORK  
 READ CAL FILE  
 FROM HARD DISK  
 READ CAL FILE  
 FROM FLOPPY DISK  
 PRESS <ENTER>  
 TO SELECT  
 PRESS <CLEAR>  
 TO ABORT

**Step 2.** Select the VNA test port where the network will be embedded, then select the **EMBED** function under the EMBED/DE-EMBED S2P FILE menu (menu DE8, top left).

**Step 3.** Select **APPLY NETWORK S2P FILE TO CAL FILE DATA**. This will take you to the EMBED/DE-EMBED S2P FILE menu (menu DE9, middle left).

**Step 4.** Select where to read the calibration file from.

The calibration file to be embedded can be stored on either the floppy or the hard disk. Once the calibration file is recalled, the EMBED/DE-EMBED S2P FILE menu (menu DE9A, bottom left) is displayed.

**MENU DE9A**  
 EMBED/DE-EMBED  
 S2P FILE  
 S2P FILE DATA  
 OF THE NETWORK  
 READ S2P FILE  
 FROM HARD DISK  
 READ S2P FILE  
 FROM FLOPPY DISK  
 PRESS <ENTER>  
 TO SELECT  
 PRESS <CLEAR>  
 TO ABORT

**Step 5.** Menu DE9A allows you to choose the .S2P file to be embedded from either the floppy or hard disk. Select the .S2P file to read.

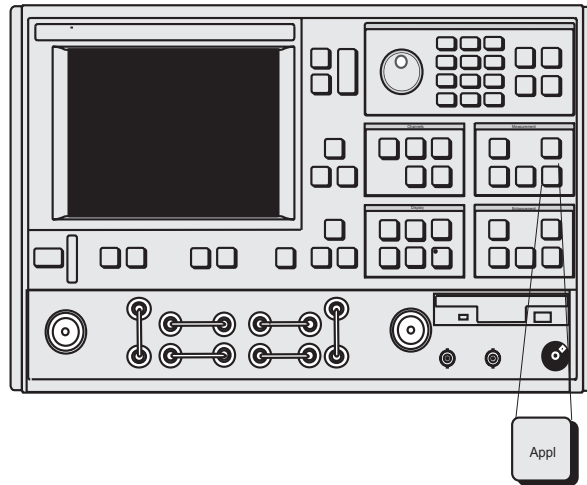
Once the .S2P file is selected, it is embedded with the calibration file. To embed additional files, save the calibration along with the embedded .S2P file onto the hard disk or floppy disk for later recall upon the next embedding operation.

**De-embedding**

De-embedding is a common technique for removing test fixture effects from a calibration, generally of microstrip or on-wafer devices. This is performed by the following:

**MENU DE8**  
 EMBED/DE-EMBED  
 S2P FILE  
 PORT 1/PORT 2  
 METHOD  
 EMBED/DE-EMBED  
 SWAP PORTS OFF  
 OF S2P DATA  
 APPLY NETWORK  
 S2P FILE DATA TO  
 CAL FILE DATA  
 PRESS <ENTER>  
 TO SELECT  
 OR CHANGE

**Step 1.** Press the APPL key on the instrument's front panel.



**MENU DE9**  
 EMBED/DE-EMBED  
 S2P FILE  
 ORIGINAL CAL FILE  
 TO APPLY NETWORK  
 READ CAL FILE  
 FROM HARD DISK  
 READ CAL FILE  
 FROM FLOPPY DISK  
 PRESS <ENTER>  
 TO SELECT  
 PRESS <CLEAR>  
 TO ABORT

**Step 2.** Select the VNA test port where the network will be embedded, then select the **DE-EMBED** function under the EMBED/DE-EMBED S2P FILE menu (menu DE8, top left).

**Step 3.** Select **APPLY NETWORK S2P FILE TO CAL FILE DATA**. This will take you to the EMBED/DE-EMBED S2P FILE menu (menu DE9, middle left).

**Step 4.** Select where to read the calibration file from.

The calibration file to be embedded can be stored on either the floppy or the hard disk. Once the calibration file is recalled, the EMBED/DE-EMBED S2P FILE menu (menu DE9A, bottom left) is displayed.

**MENU DE9A**  
 EMBED/DE-EMBED  
 S2P FILE  
 S2P FILE DATA  
 OF THE NETWORK  
 READ S2P FILE  
 FROM HARD DISK  
 READ S2P FILE  
 FROM FLOPPY DISK  
 PRESS <ENTER>  
 TO SELECT  
 PRESS <CLEAR>  
 TO ABORT

**Step 5.** Menu DE9A allows you to choose the .S2P file to be de-embedded from either the floppy or hard disk. Select the .S2P file to read.

Once the .S2P file is selected, it is de-embedded with the calibration file. To de-embed additional files, save the calibration along with the de-embedded .S2P file onto the hard disk or floppy disk for later recall upon the next de-embedding operation.

## 8-11 OPTICAL APPLICATION

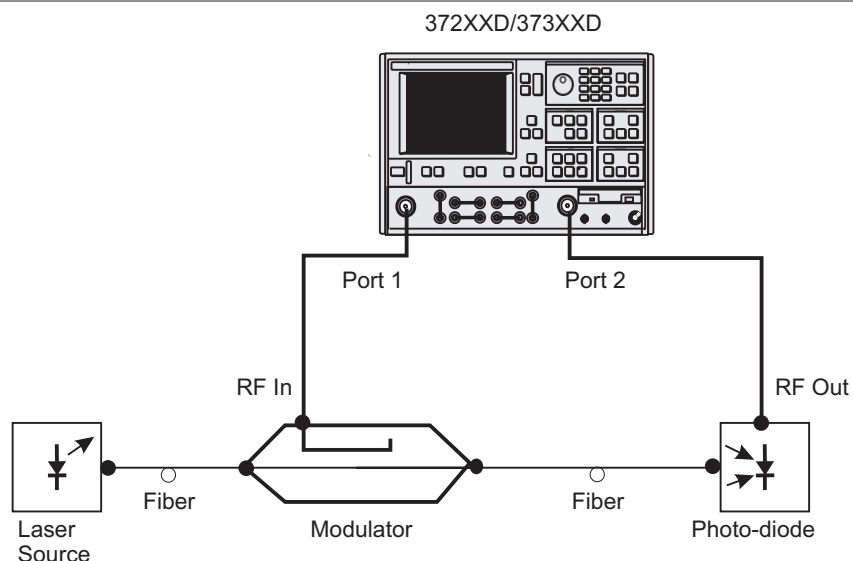
Optical applications are divided into two measurement categories, electro-optical (E/O) and opto-electrical (O/E).

E/O measurements can be performed with the 372XXD/373XXD series VNAs using the built-in E/O measurement application. On-screen menu-driven procedures guide you through the set-up and calibration required for E/O measurements of optical modulators such as bandwidth, flatness, and group delay.

O/E measurements of a photo-diode or photo-receiver can be performed with the 372XXD/373XXD series VNAs by using the built-in O/E measurement application. On-screen-menu-driven procedures guide you through the set-up and calibration required for O/E measurements such as bandwidth, flatness, and group delay.

### *E/O Measurements*

Optical modulators modulate digital data signals over a light wave carrier and send it over fiber optic networks. Since a VNA is only capable of generating and measuring electrical signals, a laser source is required to provide optical input to the modulator DUT and a photo-diode/photo-receiver is required to convert the modulator output back to an electrical signal that can be measured by the VNA. The MN4765A (65 GHz characterized photo-diode) is used with the following procedure. The equipment set up for an E/O measurement is shown in Figure 8-33, below.



**Figure 8-33.** E/O Measurement Setup

The E/O measurement application de-embeds the response of the photo-diode/photo-receiver transfer standard from a 12-term calibration to enable measurements of a modulator DUT.

**E/O Measurement Procedure**

The following procedure will explain ways of using the MN4765A photo-diode to make an E/O measurement of a modulator DUT. The same set up can be used for a user characterized photo-diode as well.

**Step 1.** Set-up the measurement as shown in Figure 8-33.

**Step 2.** Perform a 12-term calibration on the VNA over the frequency range of interest with reference planes at the DUT input and the photo-diode output. (Refer to section 7-4 for the 12-term calibration steps.)

**Step 3.** Press Save/Recall to save the calibration and set-up to the hard disk or a floppy disk.

**Step 4.** Press the Appl key to display the applications menu (left).

**Step 5.** Move the cursor to **E/O MEASUREMENT** and press Enter.

This brings up menu DE1 (left) and the step-by-step procedure, Figure 8-34, for making the measurement.

<b>MENU APPL</b>
APPLICATIONS
ADAPTER REMOVAL
SWEPT FREQUENCY
GAIN COMPRESSION
SWEPT POWER
GAIN COMPRESSION
<b>E/O MEASUREMENT</b>
O/E MEASUREMENT
MERGE CAL FILES
PRESS <ENTER> TO SELECT

<b>MENU DE1</b>
E/O MEASUREMENT
<b>MEASURE E/O DUT MODULATOR</b>
DE-EMBED TRANSFER FUNCTION OF A GENERIC NETWORK
PRESS <ENTER> TO SELECT

```

- E/O MEASUREMENT -

E/O MEASUREMENTS CAN BE REALIZED BY DE-EMBEDDING THE
CHARACTERISTICS OF A TRANSFER STANDARD (DETECTOR STD).
SIMILARLY, THE FORWARD TRANSFER FUNCTION OF A GENERIC
NETWORK CAN BE DE-EMBEDDED.

- REQUIREMENTS -

- PERFORM A RF CALIBRATION WITH FORWARD TRANSMISSION
CORRECTION - EITHER FULL 12-TERM, 1-PATH 2-PORT FWD,
OR FREQUENCY RESPONSE (FWD OR BOTH). STORE THE CAL
AND FRONT PANEL SETUP TO DISK (e.g. ORIG-E-E.CAL).
E/O MEASUREMENT
▶MEASURE E/O DUT
(MODULATOR)

- THE CHARACTERIZATION OF THE DEVICE TO DE-EMBED
SHOULD BE IN A FILE USING THE S2P FORMAT (e.g.
O-E-DET.S2P). USE AS MANY POINTS AS POSSIBLE TO
IMPROVE INTERPOLATION ACCURACY.
DE-EMBED TRANSFER
FUNCTION OF A
GENERIC NETWORK

- CAL FILES AND S2P CHARACTERIZATION FILES MUST BE
PLACED IN THE CURRENT DIRECTORY OF THE DISK.
PRESS <ENTER>
TO SELECT

- INSTRUCTIONS -

1. TO MEASURE E/O DEVICES (e.g. MODULATORS), DE-EMBED
A DETECTOR TRANSFER STANDARD (e.g. O-E-DET.S2P
FROM ORIG-E-E.CAL). IF DESIRED, SAVE RESULTS.

2. TO DE-EMBED THE FORWARD TRANSFER FUNCTION OF A
GENERIC NETWORK, SELECT A CAL FILE AND A S2P FILE.
    
```

**Figure 8-34.** E/O Measurement Menu

**Step 6.** Select **MEASURE E/O DUT (MODULATOR)** and press Enter.

MENU DE3
E/O MEASUREMENT ORIGINAL CAL FILE WITH FWD TRANS CORRECTION
READ CAL FILE FROM HARD DISK
READ CAL FILE FROM FLOPPY DISK
PRESS <ENTER> TO SELECT
PRESS <CLEAR> TO ABORT

This brings up menu DE3 (top left).

**Step 7.**

Select **READ CAL FILE FROM HARD DISK** or **READ CAL FILE FROM FLOPPY DISK** depending on where the 12-term calibration was saved in Step 3.

This bring up menu DSK2 (middle left).

**Step 8.**

Select the calibration file and press Enter.

**Step 9.**

Read the S2P file (characterization data file) for the photo-diode transfer standard. This will de-embed the photo-diode for an E/O measurement (menu DE3A, bottom left).

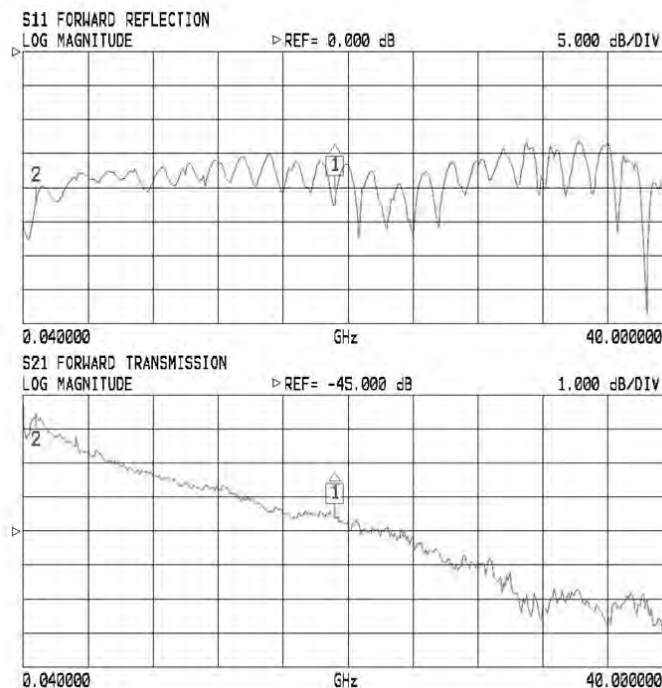
MENU DSK2
SELECT FILE TO READ
TESTCAL      CAL
PREVIOUS MENU
PRESS <ENTER> TO SELECT
PRESS <1> FOR PREVIOUS PAGE
PRESS <2> FOR NEXT PAGE

**NOTE**

If an S2P file is not available, it can be generated from the characterization data provided by the vendor. This is explained on page 8-74.

The VNA now displays the measurement of the modulator DUT. An example measurement of a 40 Gb/s NRZ modulator is shown in Figure 8-35 below.

MENU DE3A
E/O MEASUREMENT
TRANSFER STANDARD TO BE DE-EMBEDDED (DETECTOR STD)
READ S2P FILE FROM HARD DISK
READ S2P FILE FROM FLOPPY DISK
PRESS <ENTER> TO SELECT
PRESS <CLEAR> TO ABORT



**Figure 8-35.** E/O Measurement of a 40 Gb/s NRZ Modulator

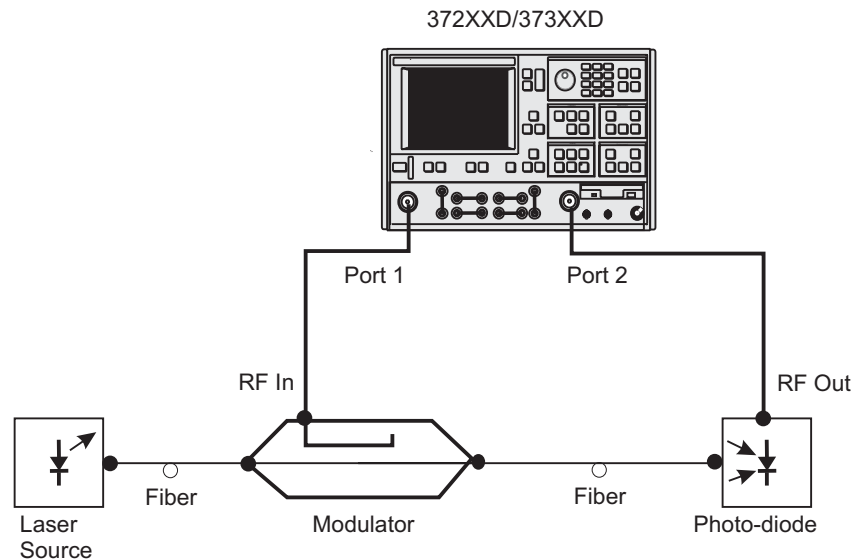
**Step 10.** Press Save/Recall and save this de-embedded calibration to the hard disk or the floppy disk.

**NOTE**

Observe that the S11 graph displays the electrical return loss (port match) of the modulator and S21 represents the transfer function of the modulator. The bandwidth of the modulator can be calculated from the S21 data by setting the delta markers or using the marker search function to find the 3 dB change in magnitude. The 3 dB bandwidth of the modulator measured in this example is 24 GHz.

**O/E Measurements**

Photo-diodes/photo-receivers convert an optical signal into an electrical signal. Bandwidth measurements can be made on a photo-diode/photo-receiver by stimulating its input with a modulated optical signal and measuring the output signal. A laser and a characterized modulator are required, in addition to the VNA, to make O/E measurements. See Figure 8-36, below, for the equipment set-up.



**Figure 8-36.** O/E Measurement Set-up

The O/E measurement application de-embeds the response of the modulator transfer standard from a 12-term calibration to enable measurements of the photo-diode DUT.

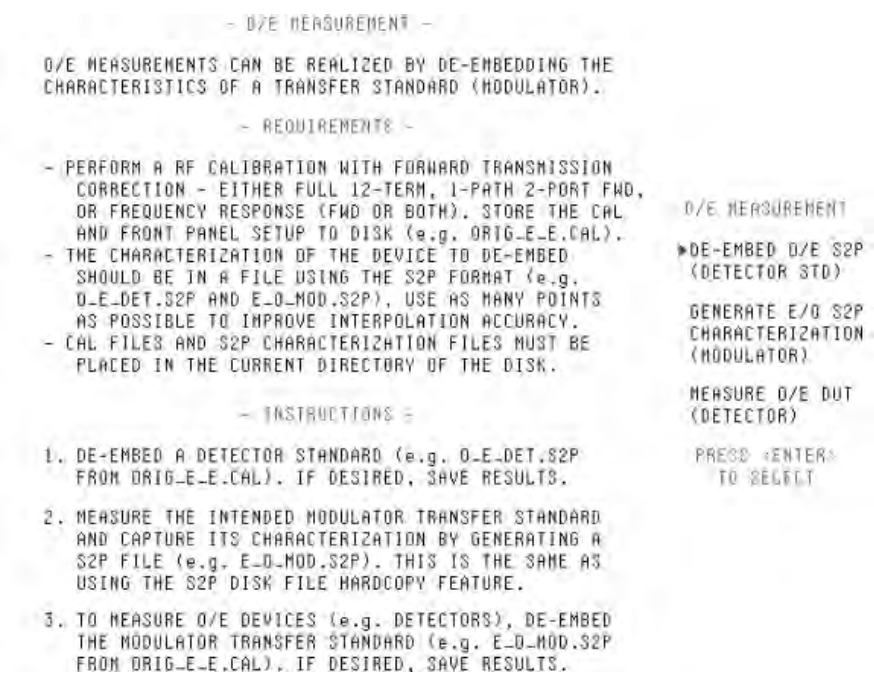
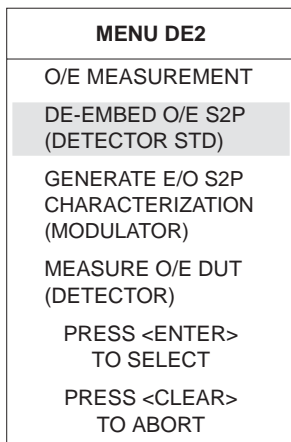
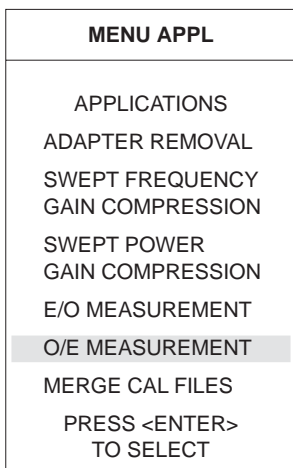
**O/E Measurement Procedure**

The following procedure will explain ways of obtaining characterization data for a modulator and then how to use it to make an O/E measurement of a photo-receiver.



- Step 1.** Set-up the measurement as shown in Figure 8-36, previous page.
- Step 2.** Perform a 12-term calibration on the VNA over the frequency range of interest with reference planes at the modulator input and the photo-receiver DUT output. (Refer to section 7-4 for the 12-term calibration steps.)
- Step 3.** Press Save/Recall to save the calibration and set up to the hard disk or a floppy disk.
- Step 4.** Press the Appl key to display the applications menu (left).
- Step 5.** Move the cursor to **O/E MEASUREMENT** and press Enter.

This brings up menu DE2 (bottom left) and the step-by-step procedure for making the measurement as shown in Figure 8-37, below.



**Figure 8-37.** O/E Measurement Menu

MENU DE5
DE-EMBED O/E S2P
ORIGINAL CAL FILE WITH FWD TRANS CORRECTION
READ CAL FILE FROM HARD DISK
READ CAL FILE FROM FLOPPY DISK
PRESS <ENTER> TO SELECT
PRESS <CLEAR> TO ABORT

**Step 6.**

The measurement of the photo-receiver DUT relies on a characterized modulator standard. If a characterized modulator is not available, an S2P file can be created by using a characterized photo-diode and de-embedding it from the 12-term calibration performed in Step 2.

With the measurement set-up as shown in Figure 8-36, select **DE-EMBED O/E S2P (DETECTOR STD)** (menu DE2, previous page).

This brings up menu DE5 (top left).

**Step 7.**

Select **READ CAL FILE FROM HARD DISK** or **READ CAL FILE FROM FLOPPY DISK** depending on where the 12-term calibration was saved in Step 3.

This brings up menu DSK2 (middle left).

MENU DSK2
SELECT FILE TO READ
TESTCAL      CAL
PREVIOUS MENU
PRESS <ENTER> TO SELECT
PRESS <1> FOR PREVIOUS PAGE
PRESS <2> FOR NEXT PAGE

**Step 8.**

Select the calibration file and press Enter.

**Step 9.**

Select **READ THE S2P FILE FROM HARD DISK** or **READ THE S2P FILE FROM FLOPPY DISK** (menu DE5A, bottom left). This is the characterization data file for the photo-diode transfer standard. This will de-embed the photo-diode for an O/E measurement.

**Step 10.**

Press the Appl key, select **O/E MEASUREMENT**. Again, then press Enter. This recalls menu DE2 (left).

MENU DE5A
DE-EMBED E/O S2P TRANSFER STANDARD TO BE DE-EMBEDDED (DETECTOR STD)
READ S2P FILE FROM HARD DISK
READ S2P FILE FROM FLOPPY DISK
PRESS <ENTER> TO SELECT
PRESS <CLEAR> TO ABORT

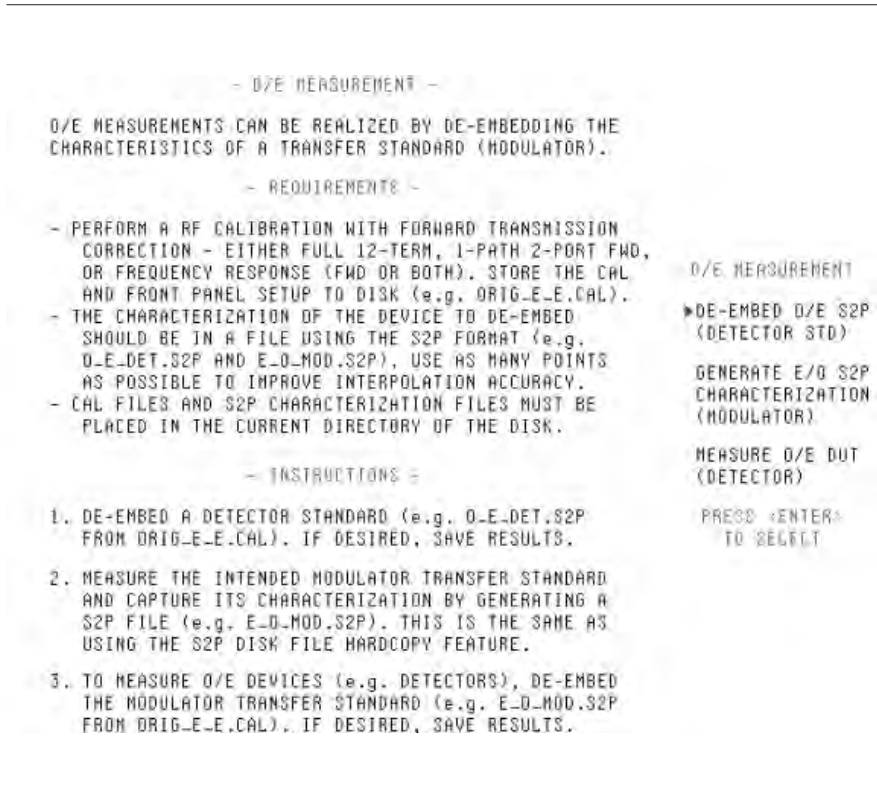
MENU DE2
O/E MEASUREMENT
DE-EMBED O/E S2P (DETECTOR STD)
GENERATE E/O S2P CHARACTERIZATION (MODULATOR)
MEASURE O/E DUT (DETECTOR)
PRESS <ENTER> TO SELECT
PRESS <CLEAR> TO ABORT

**Step 11.**

Move the cursor to **GENERATE E/O S2P CHARACTERIZATION (MODULATOR STD)** (menu DE2, left) and press Enter. This will generate an S2P characterization file for the modulator.

Once the modulator characterization S2P file has been generated, it can be used as a transfer standard for the photo-receiver DUT measurement.

After the characterization file has been saved, the VNA returns to the O/E measurement menu shown in Figure 8-38, below.



**Figure 8-38.** O/E Measurement Menu

**Step 12.**

Press the Appl key, select **O/E MEASUREMENT**. Again, then press Enter. This recalls menu DE2 (top left).

**Step 13.**

Move the cursor to **MEASURE O/E DUT (DETECTOR)** (menu DE2, top left) and press Enter.

This brings up menu DE7 (middle left).

**Step 14.**

Select **READ CAL FILE FROM HARD DISK** or **READ CAL FILE FROM FLOPPY DISK** depending on where the original 12-term calibration was saved in Step 3.

This brings up menu DSK2 (bottom left).

MENU DE2
O/E MEASUREMENT
DE-EMBED O/E S2P (DETECTOR STD)
GENERATE E/O S2P CHARACTERIZATION (MODULATOR)
MEASURE O/E DUT (DETECTOR)
PRESS <ENTER> TO SELECT
PRESS <CLEAR> TO ABORT

MENU DE7
O/E MEASUREMENT
ORIGINAL CAL FILE WITH FWD TRANS CORRECTION
READ CAL FILE FROM HARD DISK
READ CAL FILE FROM FLOPPY DISK
PRESS <ENTER> TO SELECT
PRESS <CLEAR> TO ABORT

MENU DSK2
SELECT FILE TO READ
TESTCAL      CAL
PREVIOUS MENU
PRESS <ENTER> TO SELECT
PRESS <1> FOR PREVIOUS PAGE
PRESS <2> FOR NEXT PAGE

MENU DE7A
O/E MEASUREMENT TRANSFER STANDARD TO BE DE-EMBEDDED (MODULATOR)
READ S2P FILE FROM HARD DISK
READ S2P FILE FROM FLOPPY DISK
PRESS <ENTER> TO SELECT
PRESS <CLEAR> TO ABORT

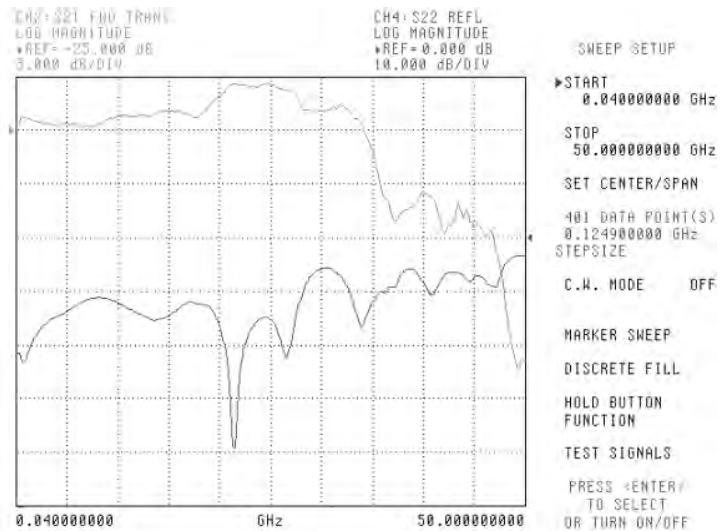
**Step 15.**

Read the S2P file for the modulator that was generated in Step 10 from the hard drive or floppy drive (menu DE7A, left). This will de-embed the modulator response from the set-up for an O/E measurement.

**NOTE**

If an S2P file is not available, it can be generated from the characterization data provided by the vendor. This is explained on page 8-74.

An O/E measurement of a photo-receiver is shown in Figure 8-39 below. The S21 measurement represents the transfer function of the photo-receiver and S22 represents the electrical return loss.



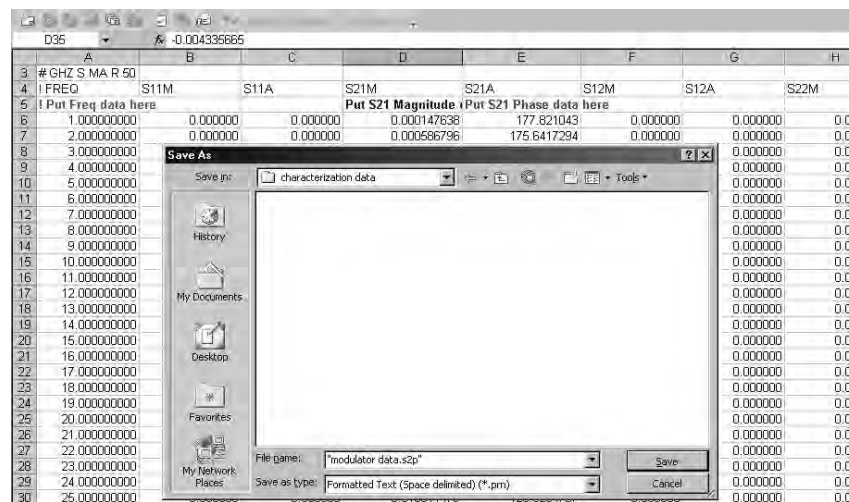
**Figure 8-39.** O/E Measurement of a Photo-receiver

### Creating a Characterization (\*S2P) File for E/O and O/E Measurements

This section guides you through the process of creating an S2P file from vendor supplied characterization data. The S2P file can then be read into the VNA for de-embedding the response of the transfer standard used for either a modulator or photo-diode.

Microsoft Excel is the recommended application for creating and storing the S2P file containing the characterization data. A sample S2P file is available for reference (contact Anritsu MMD Customer Service for a copy).

The file format is the standard S2P format that includes the four S-parameters (see the section below for details on the S2P format). The transfer function data supplied by the vendor should be copied into the columns designated for S21 data and the frequencies into the FREQ column. Once the data has been entered, the file should be saved as an S2P file (as shown in Figure 8-40 below).



**Figure 8-40.** Saving the S2P File in Excel

### S2P File Format

S2P data files are ASCII text files in which data appears line by line, one line per data point, in increasing order of frequency. Each line of data consists of a frequency value and one or more pairs of values for the magnitude and phase of each S-parameter at that frequency.

Values are separated by one or more spaces, tabs, or commands. Comments are preceded by an exclamation mark (!). Comments can appear on separate lines or after the data on any line.

The standard S2P file format consists of:

- Option Lines
- Data Lines
- Comments

The option line contains the specifications of the data, for example, the frequency units, the normalizing impedance, and the measured parameter (S, Y, Z, etc.).

The option line format is:

# <frequency unit> <parameter> <format> <Rn>

where:

#	The delimiter that tells the program you are specifying these parameters
frequency unit	The set of units desired (GHz, MHz, KHz, Hz)
parameter	The parameter desired (S, Y or Z for S1P components; S, Y, Z, G, or H for S2P components; S for S3P or S4P components)
format	The format desired (DB for dB-angle, MA for magnitude-angle, or RI for real-imaginary)
R n	The reference resistance in ohms, where n is a positive number of ohms (the real impedance to which the parameters are normalized)

The default option line for a component data files is:

# GHZ S MA R 50

For Y-parameters with real imaginary data, the option line header will change to:

# GHz Y RI R 50

The data lines contain the data of interest. Data for all four S-parameters will be listed on a single line for a particular frequency point. The format is:

Frequency S11 S21 S12 S22

**Data Line Examples:**

Frequency S11 (magnitude) S11 (angle)

0.040000000 1.426492E-04 18.642

0.139900000 2.840961E-03 22.262

Finally, the comment lines begin with an exclamation point “ ! .” They can be inserted at any point in an S2P file and are ignored by the application program. An S2P file example appears in Figure 8-41 below.

---

```

! Anritsu Company
! DATE 04/11/2002 13:16 PAGE 1
! Photo-diode receiver characterization – NRZ-40G
# GHz S MA R 50.00

```

!FREQ	S11M	S11A	S21M	S21A	S12M	S12A	S22M	S22A
0.040000000	1.426492E-04	18.642	3.008963E-04	87.040	1.618370E-04	27.317	2.708149E-04	129.056
0.139900000	2.840961E-03	22.262	6.185992E-03	-114.026	2.539190E-03	125.940	5.977178E-03	-7.691
0.239800000	3.072268E-03	97.851	7.423908E-03	109.019	3.147963E-03	-88.205	7.634960E-03	-75.071
0.339700000	1.887820E-02	81.836	3.814256E-02	-135.753	1.632677E-02	-27.669	3.348942E-02	117.818
0.439600000	2.173782E-02	142.412	4.595363E-02	72.973	1.962434E-02	107.429	3.946349E-02	40.979
0.539500000	2.634556E-02	-62.971	5.206176E-02	31.589	2.257828E-02	-22.787	4.638838E-02	70.663
0.639400000	3.060178E-02	-103.325	6.416773E-02	120.463	2.732290E-02	5.656	5.685493E-02	-124.645

---

**Figure 8-41.** S2P File Example



# **Chapter 9**

## **Time Domain**

### **Table of Contents**

---

9-1	INTRODUCTION . . . . .	9-3
9-2	TIME DOMAIN MEASUREMENTS . . . . .	9-3
9-3	OPERATING TIME DOMAIN . . . . .	9-8
9-4	WINDOWING. . . . .	9-11
9-5	GATING. . . . .	9-12
9-6	ANTI-GATING . . . . .	9-14
9-7	EXAMPLES, GATING AND ANTI-GATING . . . . .	9-14
9-8	TIME DOMAIN MENUS. . . . .	9-14



# Chapter 9

## Time Domain

### **9-1** INTRODUCTION

This chapter describes the optional Time Domain feature.

### **9-2** TIME DOMAIN MEASUREMENTS

The Option 2, Time Domain feature provides a useful measurement tool for determining the location of impedance discontinuities. Some typical applications are identifying and analyzing circuit elements, isolating and analyzing a desired response, locating faults in cables, and measuring antennas.

The relationship between the frequency-domain response and the time-domain response of a network is described mathematically by the Fourier transform.

The 37XXXD makes measurements in the frequency domain then calculates the inverse Fourier transform to give the time-domain response. The time-domain response is displayed as a function of time (or distance). This computational technique benefits from the wide dynamic range and the error correction of the frequency-domain data.

Let us examine the time-domain capabilities. Two measurement modes are available: lowpass and bandpass.

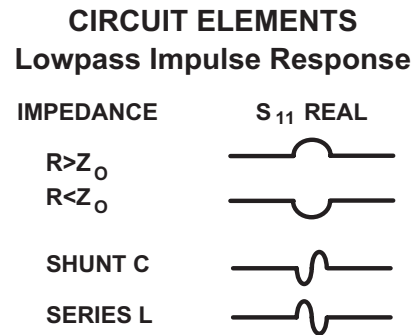
We use the lowpass mode with devices that have a dc or low-frequency response. In the lowpass mode two responses to the device-under-test (DUT) are available: impulse or step response.

The frequencies used for the test must be harmonically related (integer multiples) to the start frequency. The simplest way to calculate this relationship is to divide the highest frequency in the calibration by 1600 (the default number-of-points available); this is the start frequency. For example, if the highest frequency is 40 GHz, the calculated start frequency is 0.025 GHz (40/1600). If the highest frequency is 65 GHz, the calculated start frequency is 0.040625 GHz (65/1600).

The lowpass impulse response displays the location of discontinuities as well as information useful in determining the impedance (R, L, or C) of each discontinuity.

The impulse response is a peak that goes positive for  $R > Z_0$  and negative for  $R < Z_0$ . The height of the response is equal to the reflection coefficient:

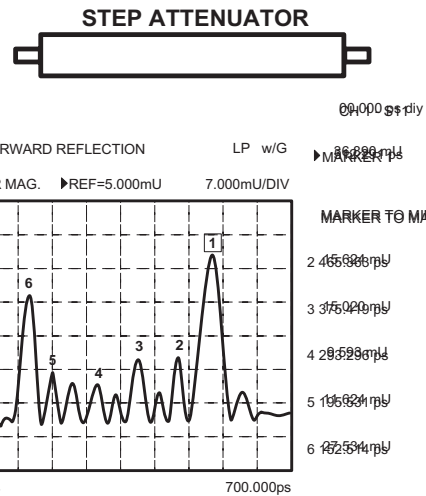
$$\rho = \frac{R - Z_0}{R + Z_0}$$



The impulse response for a shunt capacitance is a negative-then-positive peak and for a series inductance is a positive-then-negative peak (Figure 9-1).

An example of using an impulse response is a circuit impedance analysis. With an impulse response we can observe the circuit response of a passive device, such as a multi-element step attenuator (Figure 9-2), and make final, realtime adjustments during the test.

**Figure 9-1.** Lowpass Impulse Response



**Figure 9-2.** Example of Lowpass Impulse Response

In the above example, the connectors at each end have been gated out (page 9-12), which lets you better observe the internal circuit response. Each displayed marker has been manually set to the peak of the response at each adjustable circuit element. In this way, the data display lets you make the adjustment in realtime, while the marker menu shows the magnitude of the response at each marker.

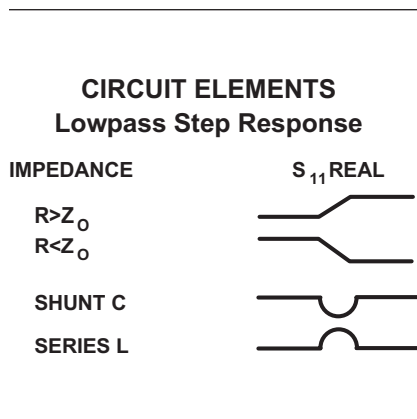
The lowpass step response displays the location of discontinuities as well as information useful in determining the impedance (R, L, or C) of each discontinuity. If you are familiar with time-domain reflectometry (TDR) you may feel more comfortable with step response, as the displays are similar.

The lowpass step response for a resistive impedance is a positive level shift for  $R > Z_0$  and a negative level shift for  $R < Z_0$ . The height of the response is equal to the reflection coefficient

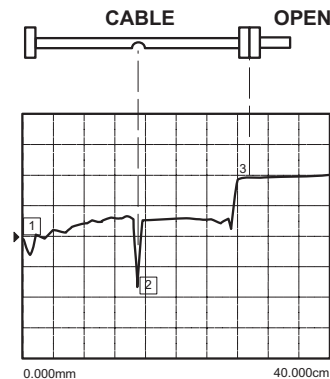
$$\rho = \frac{R - Z_0}{R + Z_0}$$

The step response for a shunt capacitance is a negative peak, and for a series inductance it is a positive peak (Figure 9-3).

An example of using the lowpass step response is cable-fault location. In the frequency domain a cable with a fault exhibits a much worse



**Figure 9-3.** Lowpass Step Response



**Figure 9-4.** Example of Lowpass Step Response

match than a good cable. Using lowpass step response, both the location of the discontinuity and the information about its type are available (Figure 9-4).

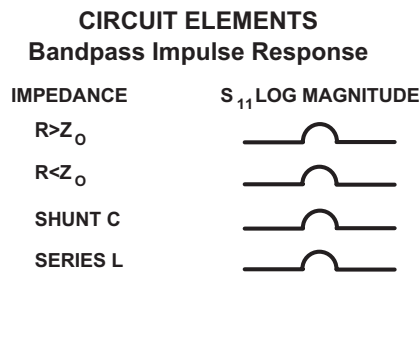
In the above example, the dip in the display shows the shunt-capacitive response caused by a crimp in the cable. The response at the end of the cable shows the step-up that is typical of an open (Figure 9-3, left).

The 37XXXD bandpass mode gives the response of the DUT to an RF-burst stimulus. Two types of response are available: impulse and phasor-impulse. An advantage of the bandpass mode is that any frequency range can be used. Use this mode with devices that do not have a dc or low-frequency path.

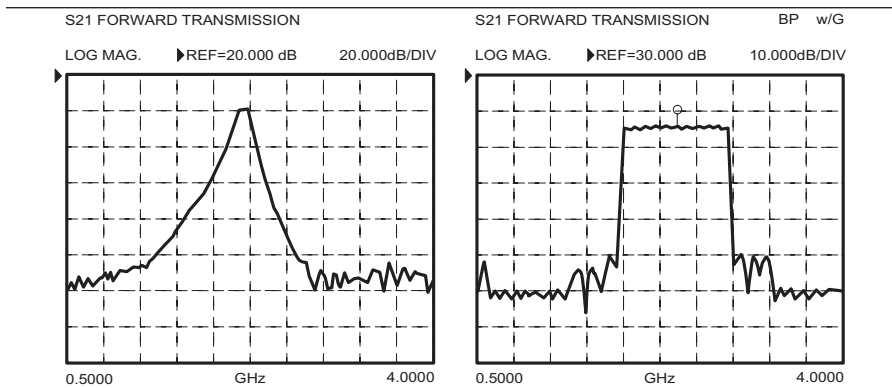
Use the bandpass-impulse response to show the location of a discontinuity in time or distance, as indicated by changes in its magnitude. Unlike the lowpass mode, no information as to the type of the discontinuity is available. A typical use for this mode is to measure devices—such as, filters, waveguide, high-pass networks, bandpass networks—where a low-frequency response is not available.

The bandpass-impulse response for various impedance discontinuities is shown in Figure 9-5. As we can see, no information about the type of discontinuity is available.

An example of using the bandpass-impulse response, is the pulse height, ringing, and pulse envelope of a bandpass filter (Figure 9-6). Use the phasor-impulse response with bandpass response to determine the type of an isolated impedance discontinuity.

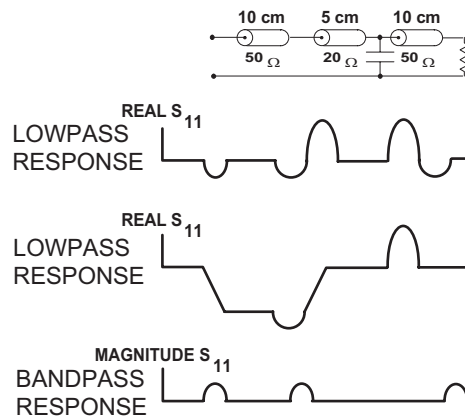


**Figure 9-5.** Bandpass Impulse Response



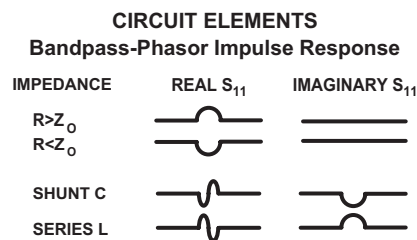
**Figure 9-6.** Example of Bandpass-Impulse Response

After the bandpass-impulse response has been isolated, the phasor-impulse response for a resistive-impedance-level change is a peak that goes positive ( $R > Z_0$ ) for the real part of  $S_{11}$  and negative for  $R < Z_0$ . The imaginary part remains relatively constant. In each case the peak is proportional to the reflection coefficient. The phasor-impulse response for a shunt capacitance is a negative-going peak in the imaginary part of  $S_{11}$ . For a series inductance, it is a positive going peak (Figure 9-7).



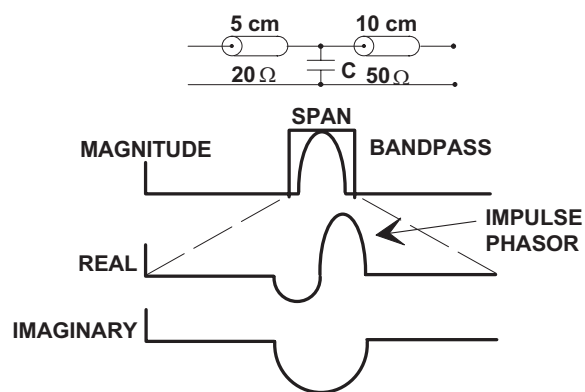
**Figure 9-7.** Complex Impedances

Next, let us look at a complex circuit. A resistive impedance change  $R < Z_0$  and a shunt capacitance and series inductance. These impedance changes are shown in the time domain for the lowpass-impulse response, lowpass-step response, and bandpass-impulse response (Figure 9-8).



**Figure 9-8.** Bandpass Phasor Response

The 37XXXD processes bandpass-impulse-response data to obtain phasor-impulse response. This becomes most advantageous where both a reactive reflection and an impedance change occur at the same location. The real part of the time-domain response shows the location of impedance level changes, while the imaginary part shows the type of reactive discontinuity. Phasor-impulse response displays one discontinuity at a time (Figure 9-9).

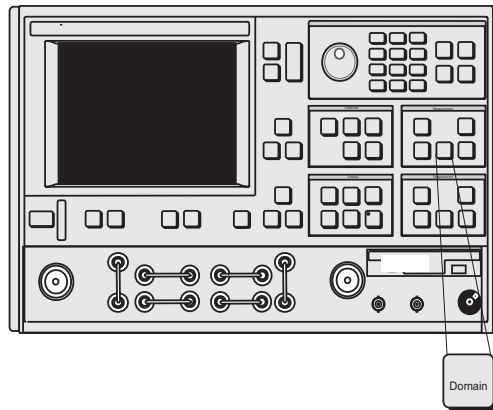


**Figure 9-9.** Phasor-Impulse Response Data

**9-3 OPERATING TIME DOMAIN**

To operate in the time domain mode, press the Domain key (below). A domain menu (Figure 9-10) lets you select the frequency- or time-domain modes by simple cursor selection. The 37XXXD defaults to the frequency domain.

Select time or distance for the horizontal axis. The 37XXXD defaults to time axis.



SET  
DIELECTRIC  
CONSTANT  
AIR  
(1.000649)  
POLYETHYLENE  
(2.26)  
TEFLON  
(2.10)  
MICROPOROUS  
TEFLON  
(1.69)  
OTHER  
XXXX.XX  
PRESS <ENTER>  
TO SELECT

**NOTE**

If you select distance, be sure to set the dielectric constant in the Reference Delay menu (Figure 9-11).

DOMAIN  
FREQUENCY  
FREQUENCY  
WITH TIME  
GATE  
TIME  
LOWPASS MODE  
TIME  
BANDPASS  
MODE  
DISPLAY  
TIME/DISTANCE  
SET RANGE  
SET GATE  
GATE ON/OFF  
HELP  
PRESS <ENTER>  
TO SELECT  
OR SWITCH

DOMAIN  
FREQUENCY  
FREQUENCY  
WITH TIME  
GATE  
TIME  
LOWPASS MODE  
TIME  
BANDPASS  
MODE  
DISPLAY  
TIME/DISTANCE  
SET RANGE  
SET GATE  
GATE ON/OFF  
HELP  
PRESS <ENTER>  
TO SELECT  
OR SWITCH

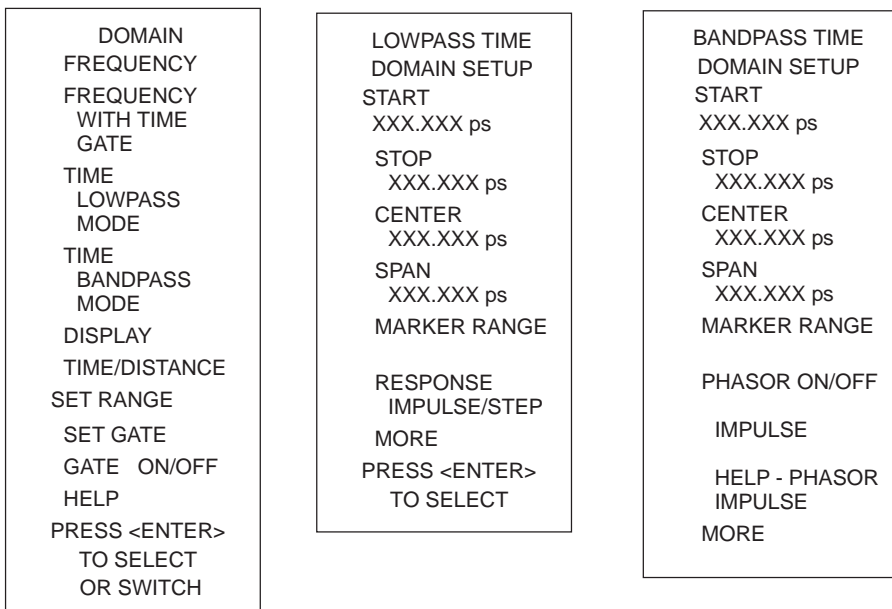
DOMAIN  
FREQUENCY  
FREQUENCY  
WITH TIME  
GATE  
TIME  
LOWPASS MODE  
TIME  
BANDPASS MODE  
DISPLAY  
TIME/DISTANCE  
SET RANGE  
SET GATE  
GATE ON/OFF  
HELP  
PRESS <ENTER>  
TO SELECT  
OR SWITCH

**Figure 9-11.** Reference Delay Menu

**Figure 9-10.** Domain Menu



Select SET RANGE and use the START/STOP or GATE/SPAN selections to set the range (Figure 9-12).

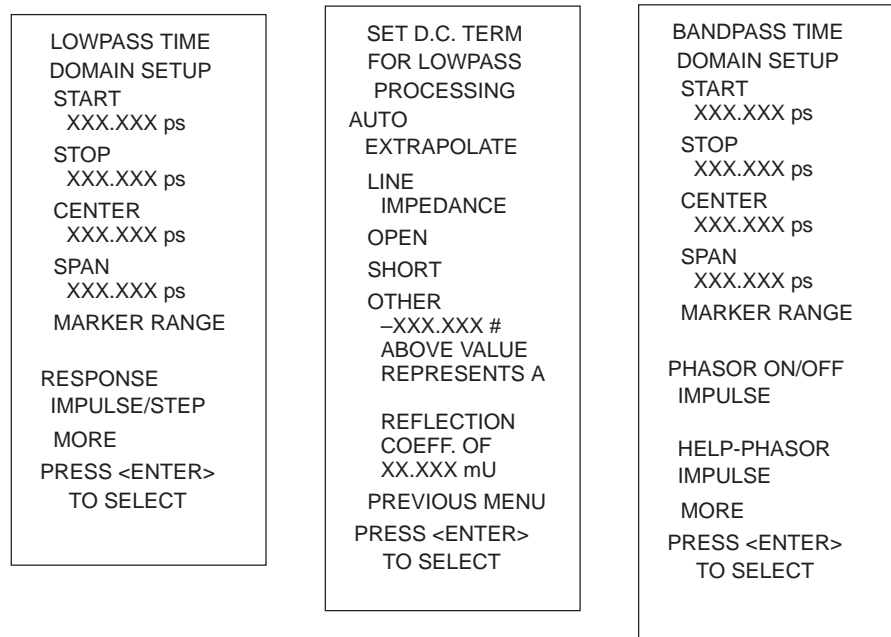


**Figure 9-12.** Set Range Menu

For the lowpass mode select either IMPULSE or STEP Response and set the DC term. The 37XXXD defaults to the IMPULSE Response and the AUTO EXTRAPOLATE mode for the DC term (Figure 9-13).

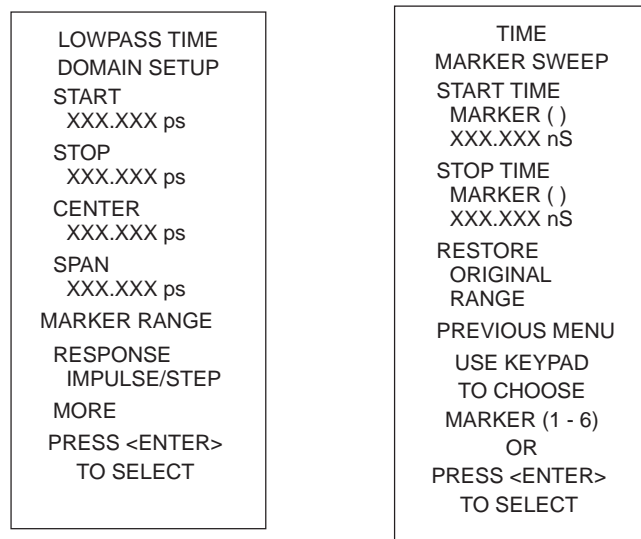
**NOTE**

The bandpass mode displays Bandpass Impulse Response unless we select Phasor Impulse Response.



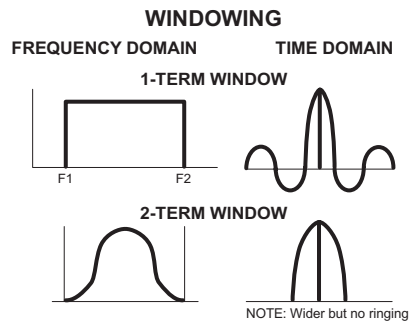
**Figure 9-13.** Response Menus

The Marker Range menu allows us to zoom in and display the range between two selected markers (Figure 9-14).



**Figure 9-14.** Marker Range Menus

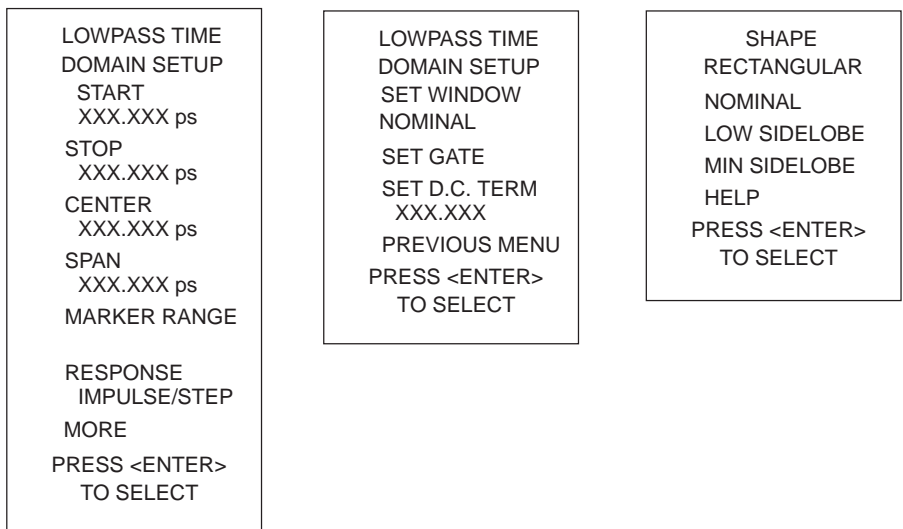
**9-4 WINDOWING**



**Figure 9-15.** Windowing

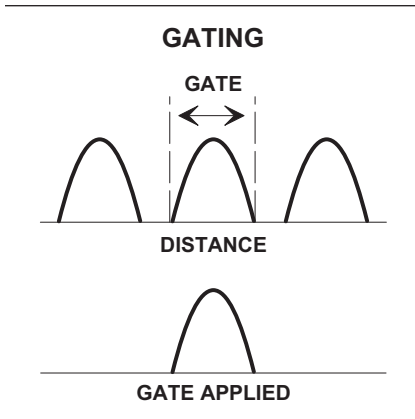
Windowing is a frequency filter that we apply to the frequency-domain data when we convert it to time-domain data. This filtering rolls off the abrupt transition at F1 and F2. This effectively produces a time-domain response with lower sidelobes. Windowing allows a limited degree of control over the pulse shape, trading off ringing (sidelobes) for pulse width (Figure 9-15).

We select windowing from the Time Domain Setup menu. Four different windows are available: RECTANGLE, NOMINAL, LOW SIDELOBE, and MIN SIDELOBE. The RECTANGLE option provides the narrowest pulse width, while the MIN SIDELOBE option provides the least ringing (fewest sidelobes). The 37XXXD defaults to the NOMINAL option, which is acceptable for most measurements. Windowing menus are shown in Figure 9-16.



**Figure 9-16.** Window Shape Menus

**9-5 GATING**

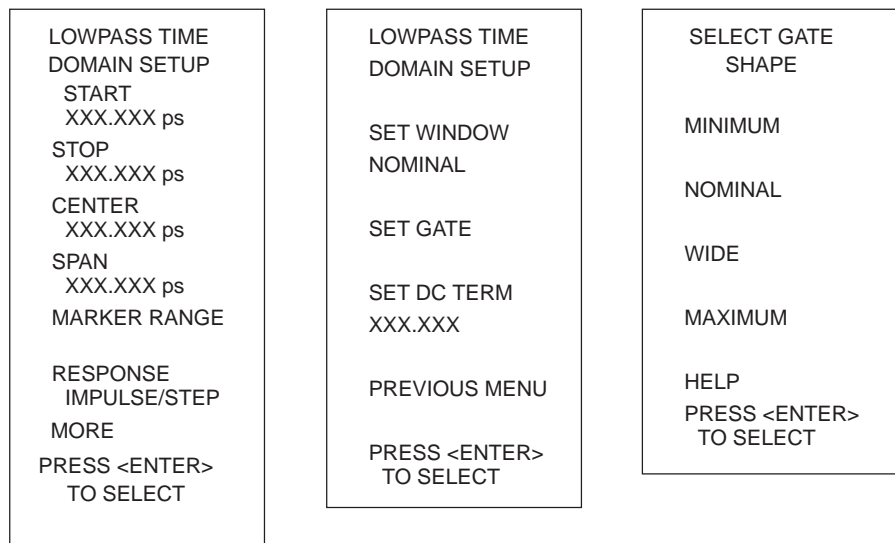


**Figure 9-17.** Gating

Gating is a time filter that allows for removing unwanted time-domain responses by gating the desired response. We can view the isolated response in both time domain—and in the frequency domain—using the FREQUENCY WITH TIME GATE selection (Figure 9-17).

There are four different gate shapes available: MINIMUM, NOMINAL, WIDE, and MAXIMUM (Figure 9-18). The 37XXXD defaults to the NOMINAL gate. To specify a different shape simply enter the Gate menu and select the desired gating shape. The MINIMUM has the sharpest rolloff and some frequency domain ripple, while MAXIMUM has the least rolloff and best residual ripple. Figures 9-18A through 9-18D, on the next page, show gating shapes.

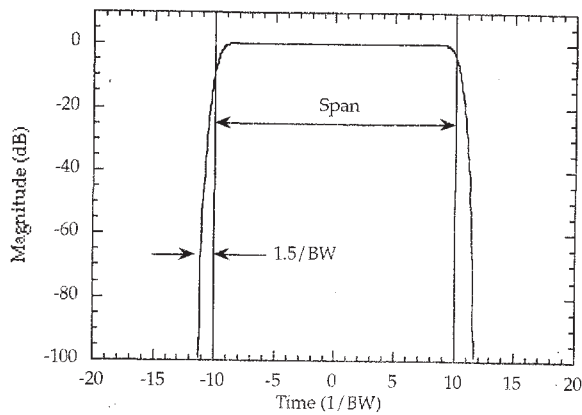
The combinations of gate/window shapes will be restricted. For the MINIMUM gate shape, the LOW and MIN SIDELOBE window shape will not be allowed. For the NOMINAL gate shape, the MIN SIDELOBE window will not be allowed. If the user has set the window shape to MIN or LOW SIDELOBE and changes the-gate shape to MINIMUM, the window will be reset to NOMINAL. If the user has set the window to MIN SIDELOBE and changes the gate shape to NOMINAL, the window will be reset to LOW SIDELOBE. Gate shapes will be adjusted in a similar manner.



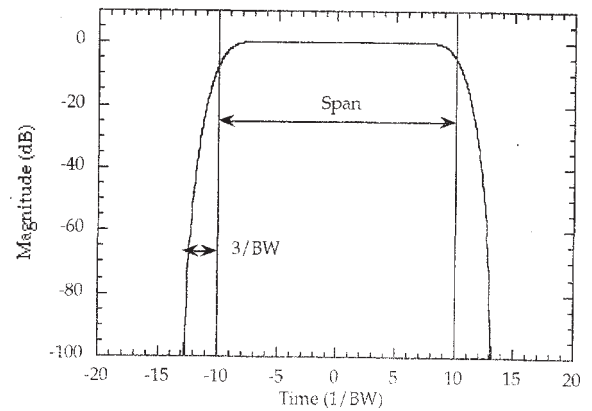
**Figure 9-18.** Gating Menus

An informational message will be displayed in the data area when the window or gate shape reset in this way. The message will last two sweeps and will say:

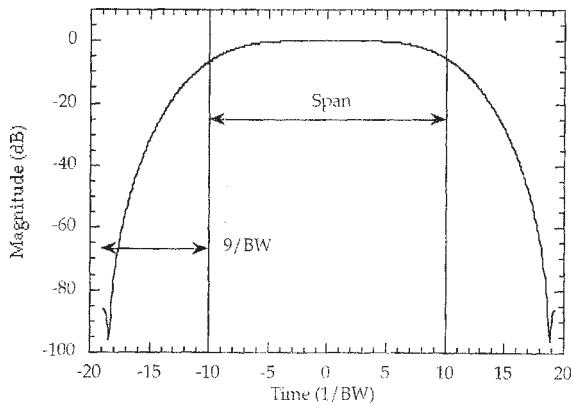
“GATE SHAPE ADJUSTED” or “WINDOW SHAPE ADJUSTED” depending on which was changed by the software.



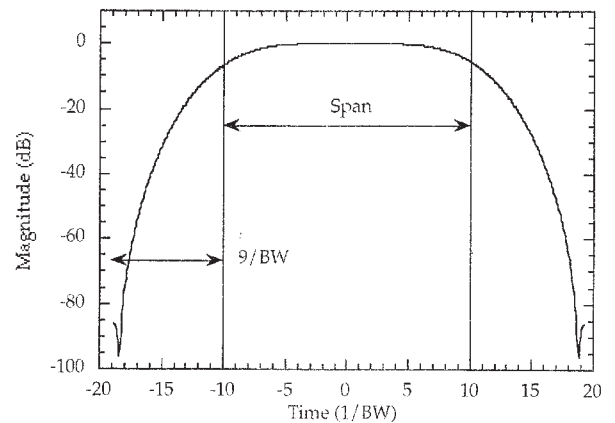
**Figure 9-18A.** Minimum Gate Shape



**Figure 9-18B.** Nominal Gate Shape



**Figure 9-18C.** Wide Gate Shape



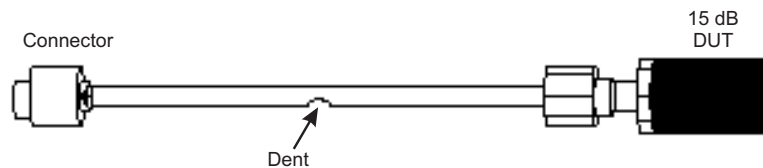
**Figure 9-18D.** Maximum Gate Shape

**9-6 ANTI-GATING**

Anti-gating is the opposite of gating. Whereby, gating provides for removing all but the desired response, anti-gating displays all but the desired response. To provide anti-gating, gate in the normal manner, except use a minus value for the SPAN width.

**9-7 EXAMPLES, GATING AND ANTI-GATING**

Examples of anti-gating are shown in Figures 9-19 through 9-24. The figures, all captured from an actual VNA display, show a sequence of measurements using gating and anti-gating to enhance measurement technique and accuracy. The examples use a dented length of semi-rigid cable having a connector on one end and a connector-DUT on the other end, as shown below. The DUT has a smoothly varying 15 dB return loss.

**9-8 TIME DOMAIN MENUS**

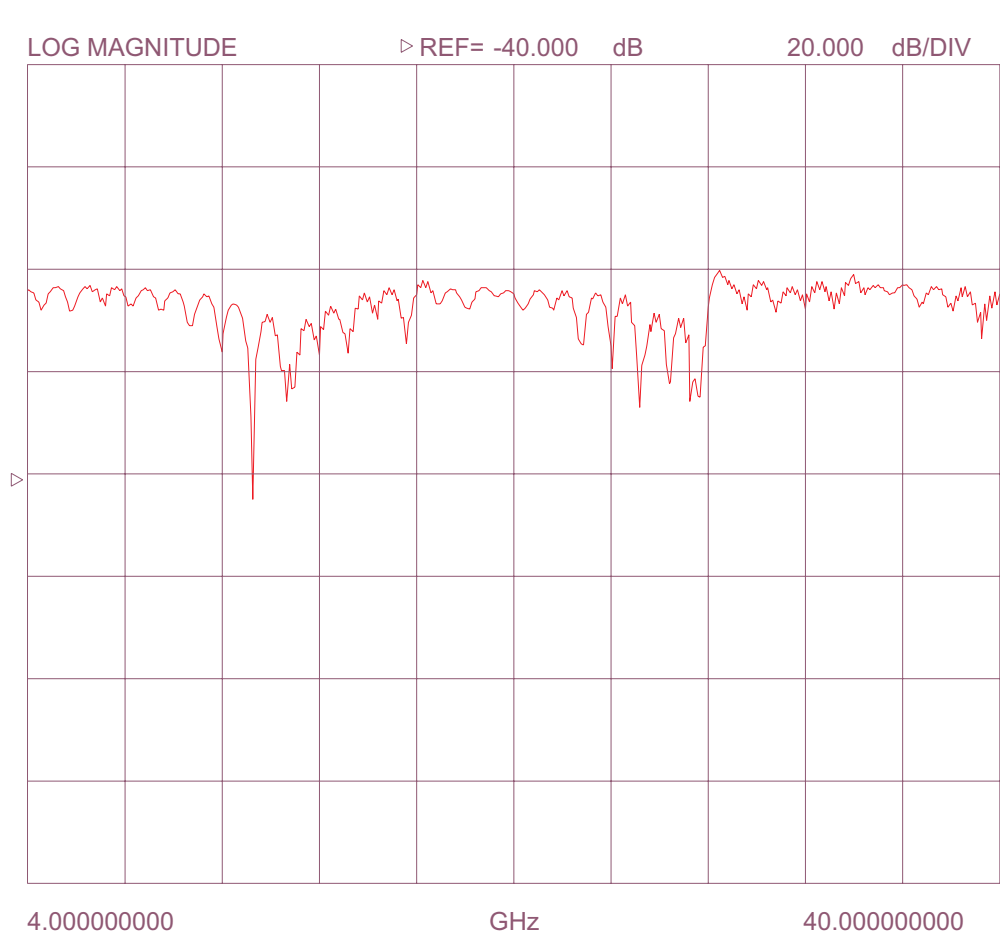
A flow diagram of the menus associated with the Time Domain Option is shown in foldout Figure 9-25. The menu choices are described in Appendix A. They appear in alphabetical order by their call letters: TD1, TD2, TD2dl, etc.

3 37369A

MODEL: DATE: 03/27/96 15:10  
DEVICE: OPERATOR:

START: 4.00000000 GHz GATE START: ERROR CORR: REFL PORT1  
STOP: 40.00000000 GHz GATE STOP: AVERAGING: 1 PT  
STEP: 0.09000000 GHz GATE: IF BNDWDTH: 1 KHz  
WINDOW:

S11 FORWARD REFLECTION



- DOMAIN
- > FREQUENCY
- FREQUENCY WITH TIME GATE
- TIME LOWPASSMODE
- TIME BANDPASSMODE
- SETUP
- DISPLAY
- TIME/ DISTANCE
- SET RANGE
- SET GATE
- GATE OFF
- HELP
- PRESS <ENTER> TO SELECT OR SWITCH

Figure 9-19. Frequency Domain Trace of Test Cable—Gating Off

37369A

MODEL: DATE: 03/27/96 15:12  
 DEVICE: OPERATOR:

START: 4.00000000 GHz GATE START: 315.0000 ps ERROR CORR: REFL PORT1  
 STOP: 40.00000000 GHz GATE STOP: 165.0000 ps AVERAGING: 1 PT  
 STEP: 0.09000000 GHz GATE: NOMINAL IF BNDWIDTH: 1 KHz  
 WINDOW: NOMINAL

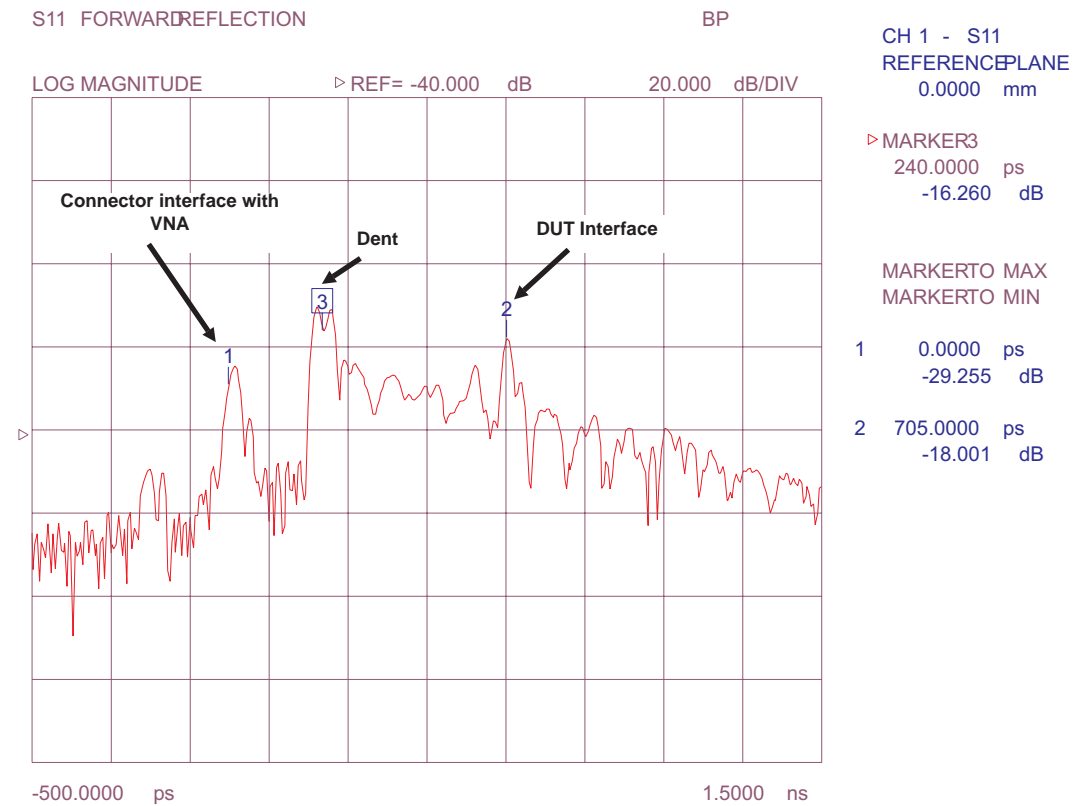


Figure 9-20. Time Domain Trace of Test Cable—Gating Off



37369A

MODEL: DATE: 03/27/96 15:14  
 DEVICE: OPERATOR:

START: 4.00000000 GHz GATE START: 642.5000 ps ERROR CORR: REFL PORT1  
 STOP: 40.00000000 GHz GATE STOP: 767.5000 ps AVERAGING: 1 PT  
 STEP: 0.09000000 GHz GATE: NOMINAL IF BNDWDTH: 1 KHz  
 WINDOW: NOMINAL

S11 FORWARD REFLECTION

BP w/GATE

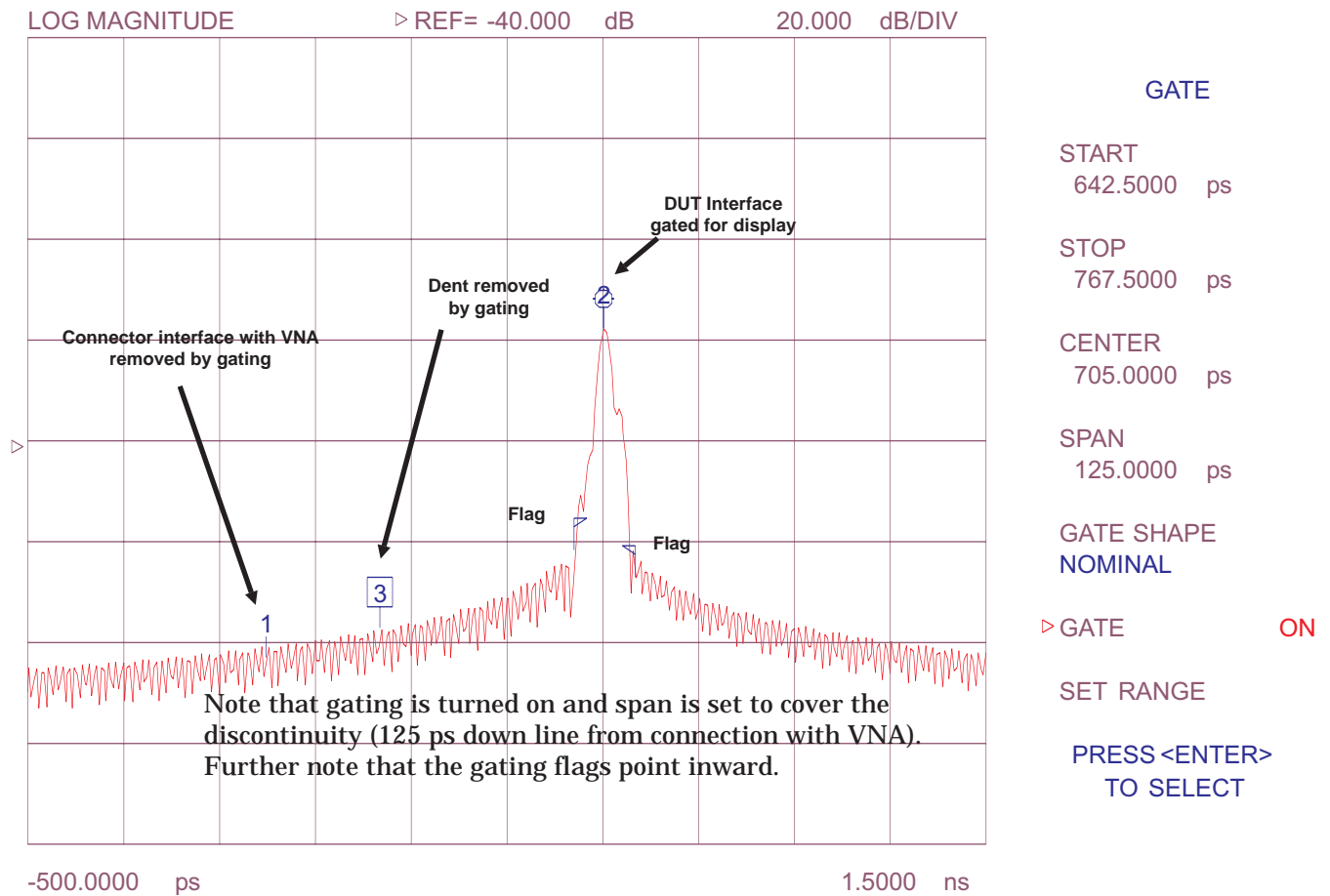


Figure 9-21. Time Domain Trace of Test Cable—Gating On and Positioned Over DUT Interface Discontinuity.

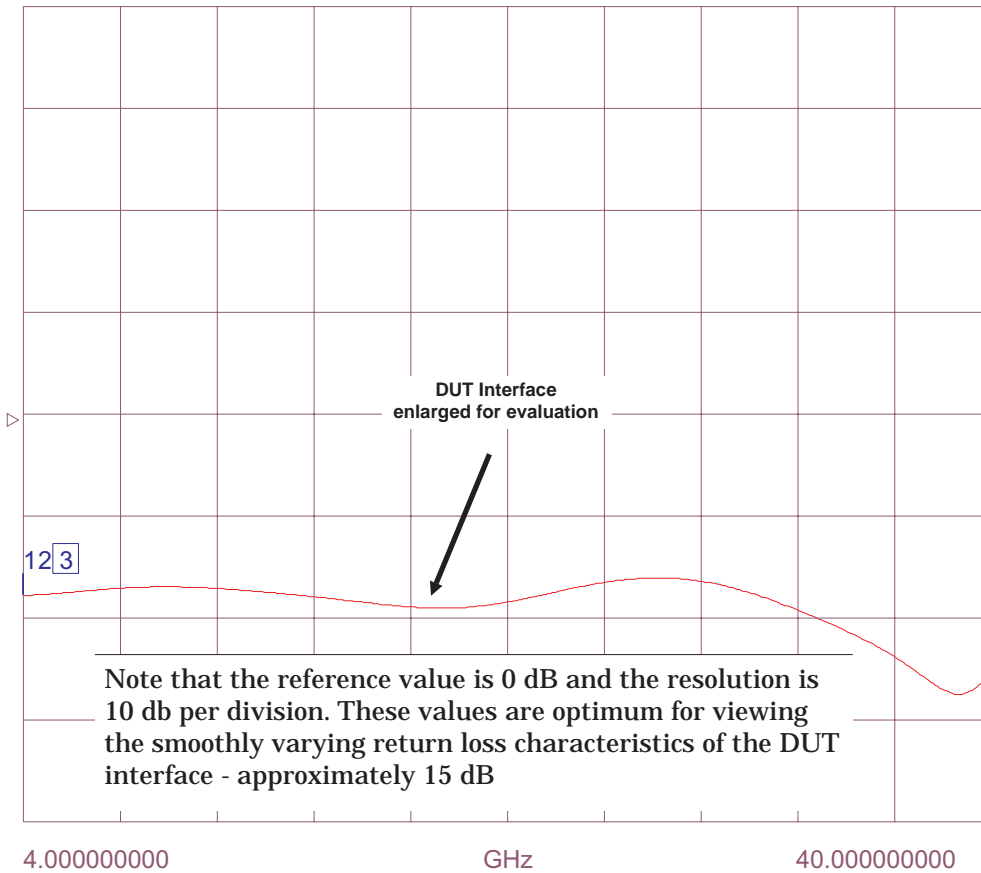
MODEL: DATE: 03/27/96 15:16  
 DEVICE: OPERATOR:

START: 4.000000000 GHz GATE START: 642.5000 ps ERROR CORR: REFL PORT  
 STOP: 40.000000000 GHz GATE STOP: 767.5000 ps AVERAGING: 1 PT  
 STEP: 0.090000000 GHz GATE: NOMINAL IF BNDWDTH: 1 KHz  
 WINDOW: NOMINAL

S11 FORWARD REFLECTION

FGT

LOG MAGNITUDE ▷ REF= 0.000 dB 10.000 dB/DIV



SET SCALING  
 OR PRESS  
 <AUTOSCALE>  
 -LOG MAG-  
 RESOLUTION  
 10.000 dB/DIV  
 ▷ REFERENCEVALUE  
 0.000 dB  
 REFERENCELINE  
 4

Note that the reference value is 0 dB and the resolution is 10 db per division. These values are optimum for viewing the smoothly varying return loss characteristics of the DUT interface - approximately 15 dB

Figure 9-22. Frequency Domain Trace of DUT

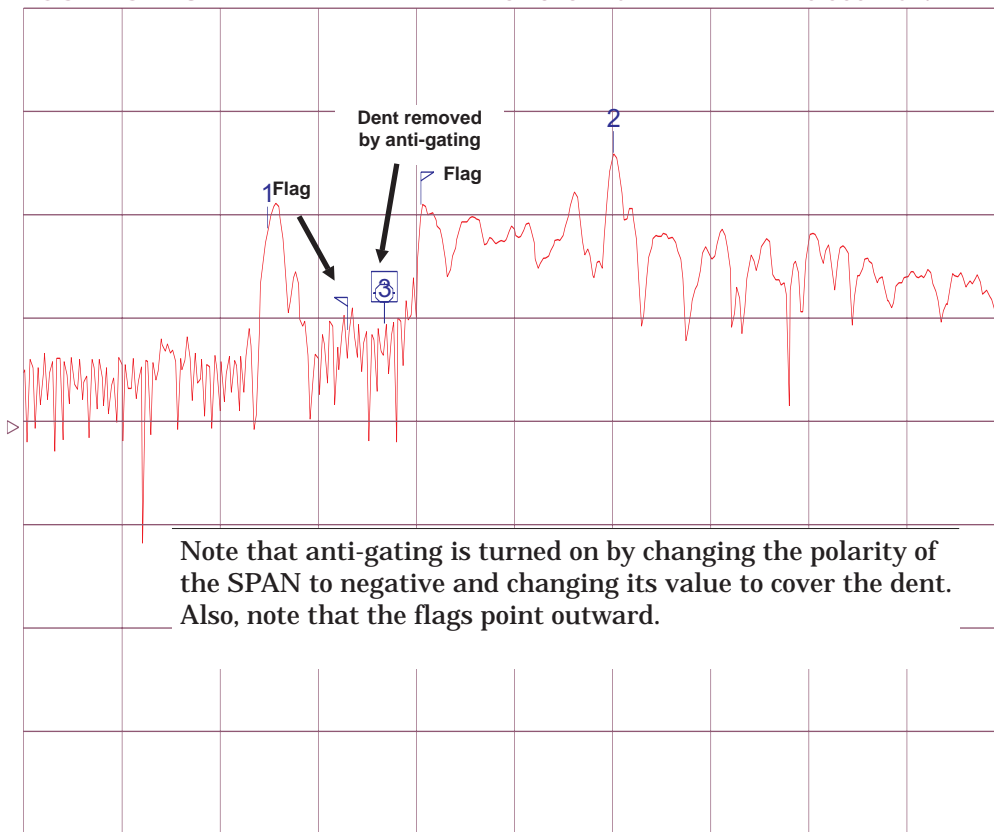
MODEL: DATE: 03/27/96 15:19  
 DEVICE: OPERATOR:

START: 4.000000000 GHz GATE START: 315.0000 ps ERROR CORR: REFL PORT1  
 STOP: 40.000000000 GHz GATE STOP: 165.0000 ps AVERAGING: 1 PT  
 STEP: 0.090000000 GHz GATE: NOMINAL IF BNDWIDTH: 1 KHz  
 WINDOW: NOMINAL

S11 FORWARD REFLECTION

BP w/GATE

LOG MAGNITUDE REF= -87.348 dB 20.000 dB/DIV



GATE

START 315.0000 ps

STOP 165.0000 ps

CENTER 240.0000 ps

SPAN -150.0000 ps

GATE SHAPE NOMINAL

> GATE (

SET RANGE

PRESS <ENTER>  
TO SELECT

-500.0000 ps

**Figure 9-23.** Time Domain Trace of Test Cable—Gating On and Positioned Over Dent (Cable Fault) Interface Discontinuity.

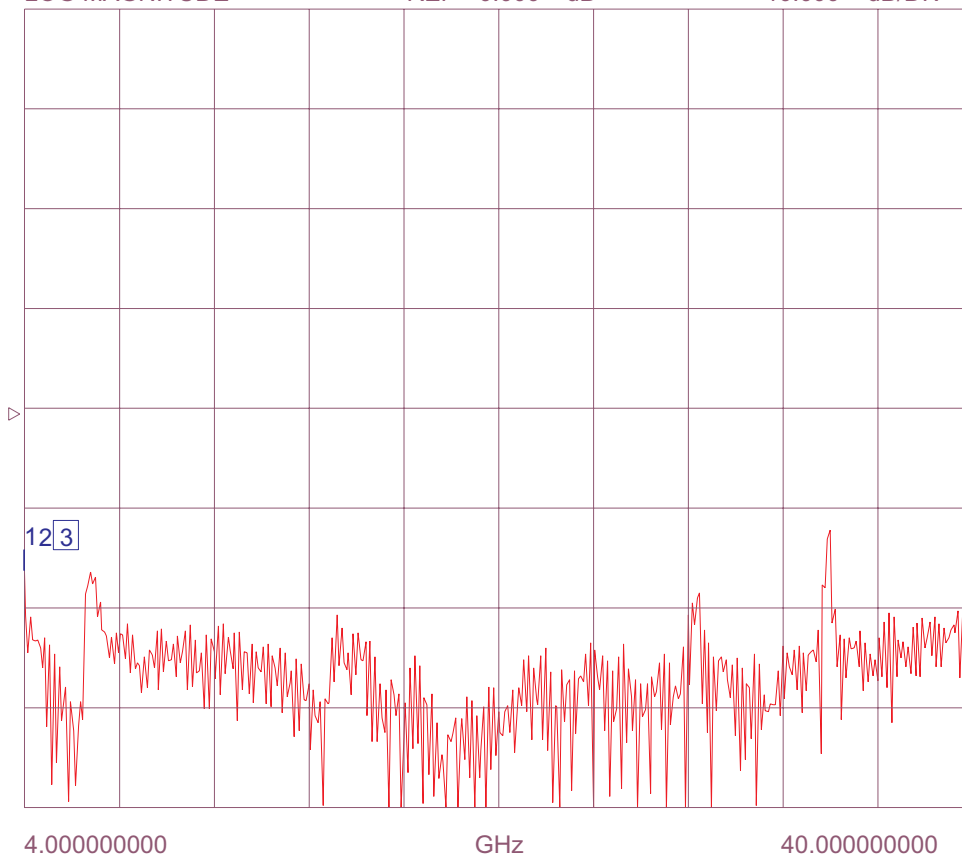
MODEL: DATE: 03/27/96 15:23  
 DEVICE: OPERATOR:

START: 4.00000000 GHz GATE START: 340.0000 ps ERROR CORR: REFL PORT1  
 STOP: 40.00000000 GHz GATE STOP: 140.0000 ps AVERAGING: 1 PT  
 STEP: 0.09000000 GHz GATE: NOMINAL IF BNDWDTH: 1 KHz  
 WINDOW: NOMINAL

S11 FORWARD REFLECTION

FGT

LOG MAGNITUDE REF= 0.000 dB 10.000 dB/DIV



SET SCALING  
 OR PRESS  
 <AUTOSCALE>  
 -LOG MAG-  
 RESOLUTION  
 10.000 dB/DIV  
 REFERENCEVALUE  
 0.000 dB  
 REFERENCELINE  
 4

Figure 9-24. Frequency Domain Trace of Test Cable—Gating On

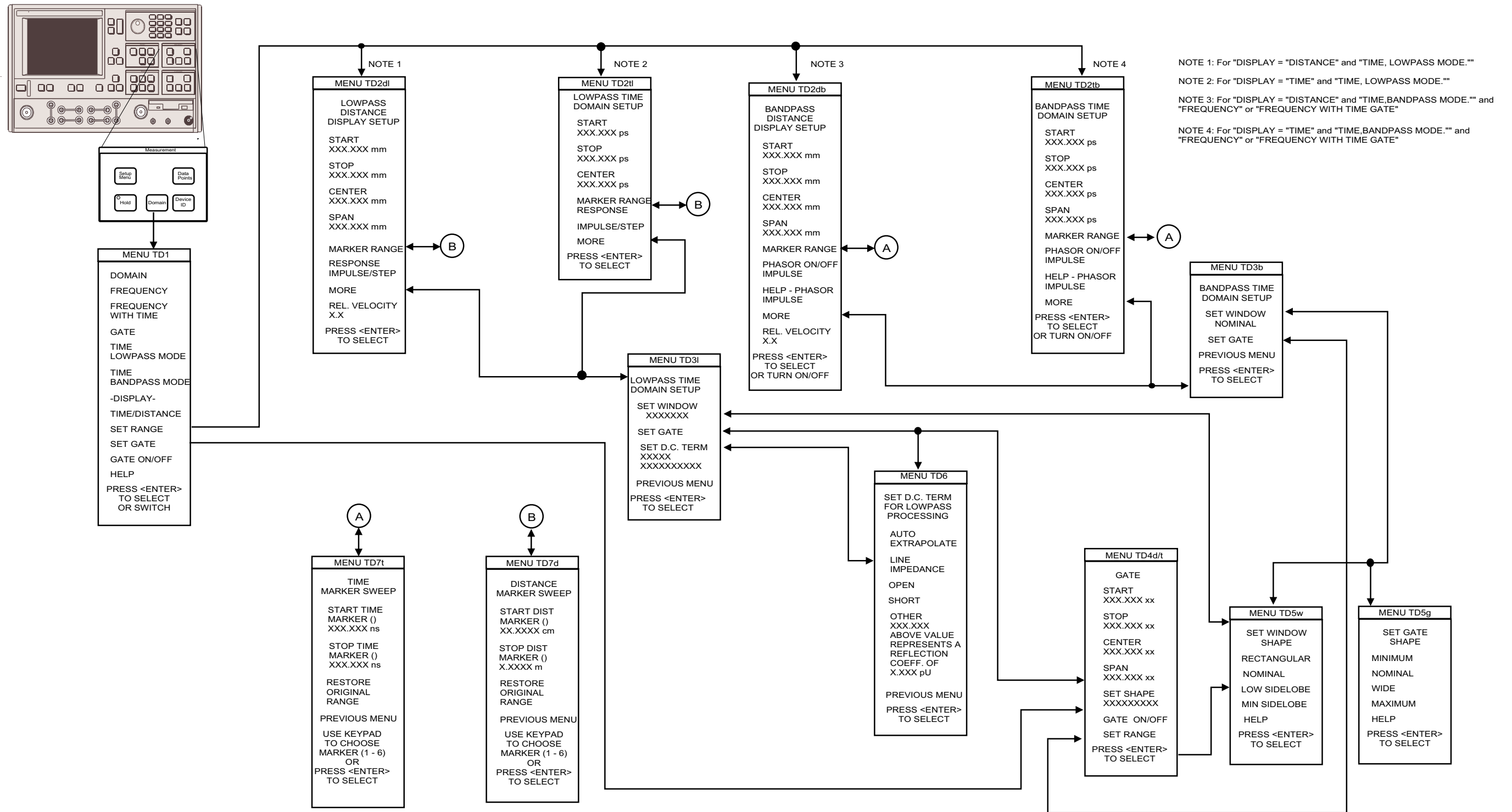


Figure 9-25. Time Domain Menu Flow



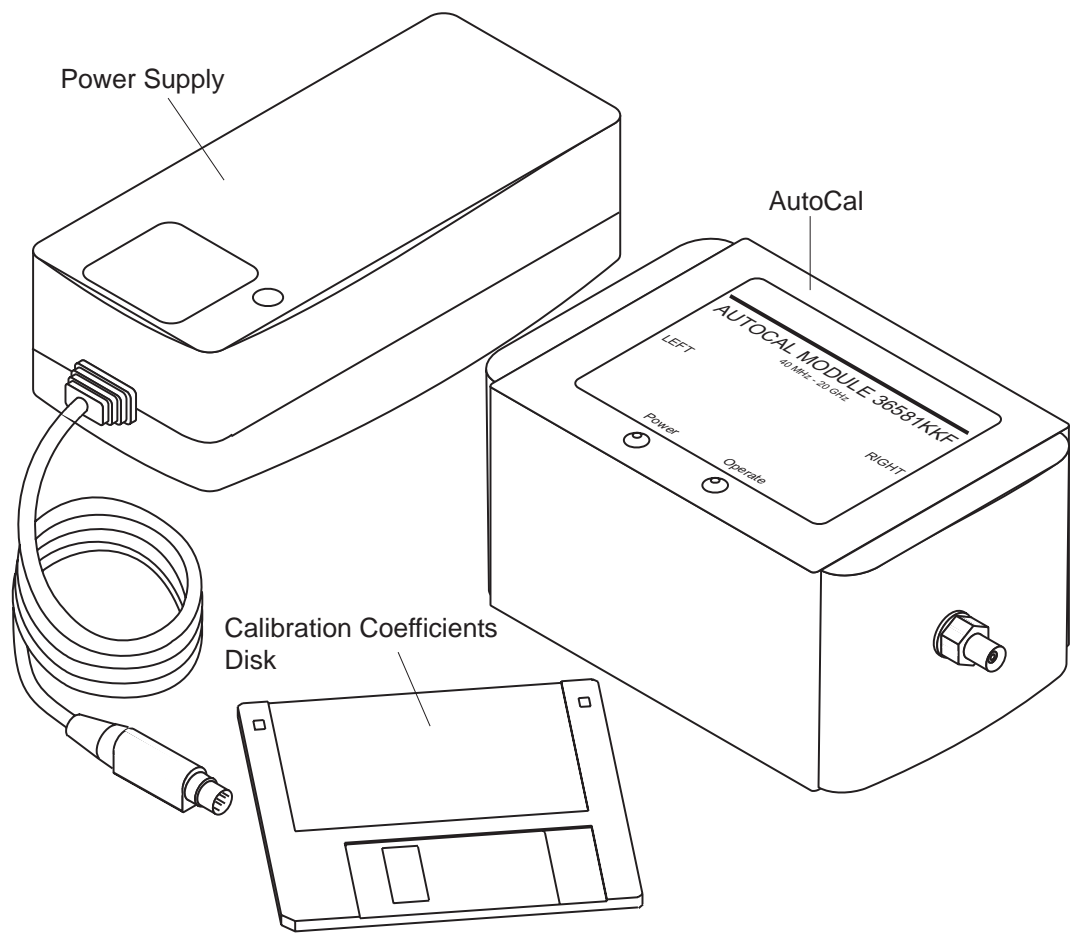
# **Chapter 10**

## **AutoCal**

### **Table of Contents**

---

10-1	INTRODUCTION . . . . .	10-3
10-2	DESCRIPTION . . . . .	10-3
10-3	CALIBRATIONS . . . . .	10-4
10-4	DEFINITION . . . . .	10-4
10-5	PHYSICAL SETUP. . . . .	10-6
10-6	CHARACTERIZATION FILES . . . . .	10-7
10-7	USING AUTOCAL . . . . .	10-9
10-8	PIN DEPTH SPECIFICATIONS . . . . .	10-13
10-9	AUTOCAL MENUS FLOW DIAGRAM . . . . .	10-14



**Figure 10-1.** AutoCal Module, Power Supply, and Calibration Coefficients Disk



# Chapter 10

## AutoCal

### 10-1 INTRODUCTION

This chapter provides a general description of the AutoCal calibrators, including specifications, setup, and the use of the associated software and on-line documentation. This series has three models, as shown below. Throughout this manual, the term AutoCal will refer to the series. Individual models will be referred to by model number. Figure 10-1 shows the AutoCal module and all of its attaching parts.

Model	Switch	Freq. Range	Connector
36581NNF	Electronic	40MHz-18 GHz	N (Male)-N(Fem)
36581KKF	Electronic	40MHz-20 GHz	K(Male)-K(Fem)
36582KKF	Mechanical	40MHz-40 GHz	K(Male)-K(Fem)

### 10-2 DESCRIPTION

The AutoCal module provides an automatic system for fast, repeatable high-quality calibrations of a Vector Network Analyzer (VNA). The AutoCal module is connected between the VNA's test ports 1 and 2 to perform the calibration. Refer to Figure 10-2 for a diagram of the AutoCal connections.

The *electronic* AutoCal modules use solid state electronic switches to exchange the internal calibration standards. Note that these units have a lower frequency limit (18 and 20 GHz). The *mechanical* module uses electro-mechanical actuators to exchange the standards and has the highest frequency limit, but has a small non-repeatability error. The *mechanical* module contains internal standards used to measure port isolation; the *electronic* module does NOT contain isolation standards and requires a manual operation to perform this measurement.

A standard serial RS-232 interface cable is used to connect the AutoCal module to the 37XXXD. Power is supplied by a connecting cable from a universal power supply (+5V, +15V, -15V for the electronic modules; +5V, +24V for the mechanical modules). A power on-off switch is not provided.

Test Port Cable Converters (Anritsu series 36583) are used during and after the calibration process to establish the desired test port connector type and sex.

## 10-3 CALIBRATIONS

Four types of calibration can be performed using AutoCal:

**One-Port:** S11 1-Port and S22 1-Port are 1-port calibrations performed on the indicated port of the VNA and are equivalent to the traditional Open-Short-Load calibrations.

**Full 2-Port:** This type is equivalent to the traditional Open-Short-Load-Thru (OSLT) calibration.

**Thru Update:** This type is a new form of calibration which is used to update an existing 12-term calibration in the VNA. This calibration could have been performed using any method of calibration which yields 12 terms (LRL, LRM, AutoCal, or OSLT). Due to cable movement and aging, the calibration may have degraded over time. The Thru Update refreshes the calibration by measuring a Thru connection and updating the Transmission Tracking and Load Match calibration coefficients.

**Adapter Removal:** This calibration measures the characteristics of male-male or female-female test port cables for subsequent measurement of non-insertable devices. An adapter is required for this calibration. Adapter Removal requires two calibration procedures in order to calculate the parameters and electrical length of the adapter.

## 10-4 DEFINITIONS

The following terms are used in explaining the calibration procedure using the AutoCal module:

**Thru:** A *thru* is a connection of the two test ports. Two kinds of thru connections are defined for the AutoCal calibration: (1) a *Calibrator* thru is an internal path through the calibrator. (2) a *True* thru is a direct cable connection between the test ports, with no intervening connectors. The calibrator thru is not as accurate as a true thru, so the you have the option during a calibration to use the more accurate method, if necessary.

**Switch Averaging:** The mechanical AutoCal module uses electro-mechanical switches to select calibration standards. These switches have a small amount of non-repeatability (typically less than -55 dB). For most calibrations, this is more than adequate because it is below connector repeatability error. If desired, you can choose to reduce the effect of this non-repeatability in the mechanical module by using *Switch Averaging*, which causes additional calibration measurements. By setting a Switch Averaging factor larger than 1, switch repeatability error will be reduced. The tradeoff is that calibration time will be proportionally increased.

**Isolation:** For certain measurements which require accurate S21 or S12 readings for very small values of those parameters, an *isolation* step is required to characterize the leakage of the VNA and test setup. The isolation step can be performed automatically as part of a “Full 2-Port” calibration when using the *mechanical* module. The isolation step requires a manual operation for the *electronic* module. In order to achieve high accuracy for the characterization of the leakage, a high averaging factor is needed.

**VNA Measurement Averaging Factor:** This is the number of measurements taken at a given data point (frequency) and may be adjusted to meet the measurement requirements. The average of all the measurements will become the measured data. For example, if 256 averages is selected, each data point is measured 256 times and the average of these measurements is displayed, then the VNA moves to the next data point.

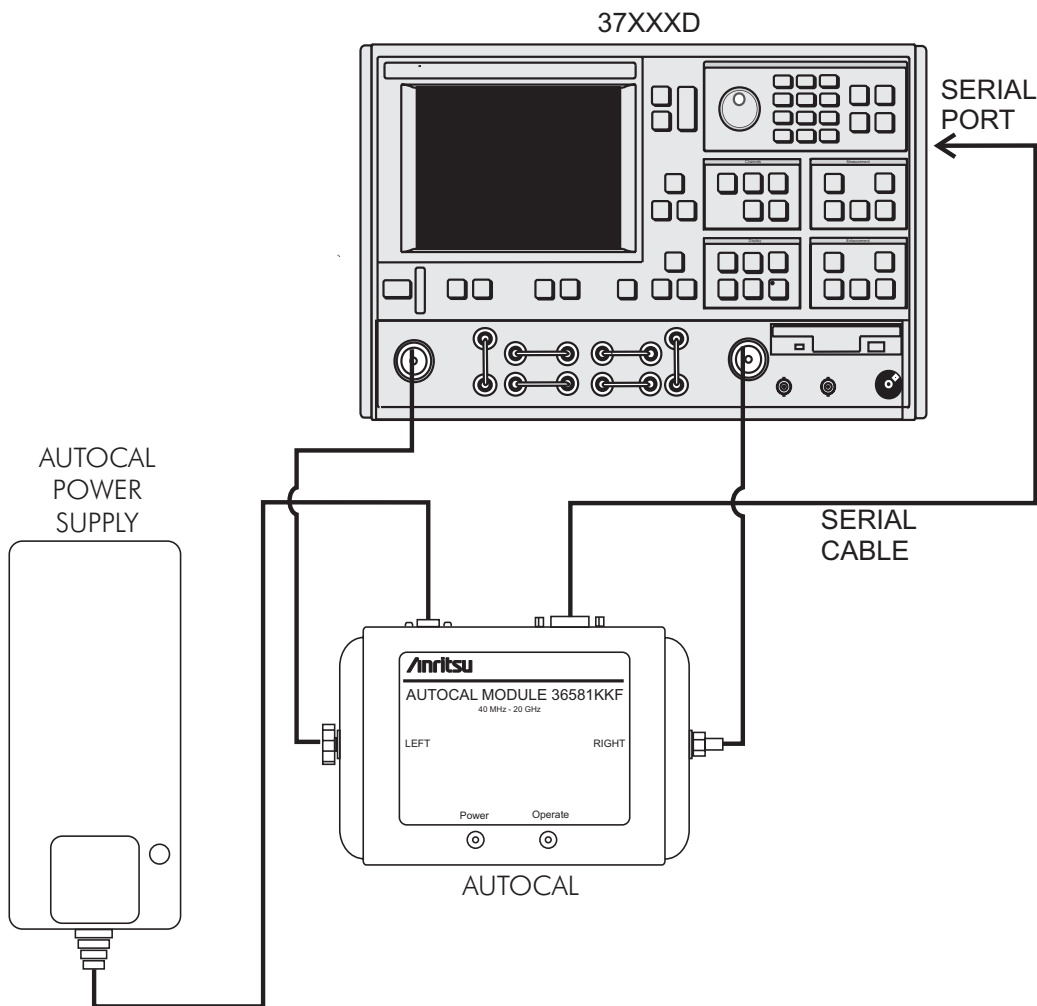
**VNA Video IF Bandwidth:** The bandwidth of the receiver may be changed to enhance the measurement accuracy or, conversely, to increase the measurement speed. Selecting the minimum IF bandwidth results in the greatest accuracy for low-signal-level measurements and the slowest measurement speed. Selecting the maximum IF bandwidth results in the greatest measurement speed and reduced accuracy on low-signal-level measurements. This can be set by using the Video IF BW key and selecting the desired IFBW.

**Characterization File:** Each calibrator module has a file containing data which characterizes each standard in the calibrator. This file also contains information (identification number, start and stop frequencies) concerning the capabilities of the calibrator. Each characterization file has the extension “.acd.” When modules are changed, you must install the appropriate new characterization file. This file can be installed using the Util key (AutoCal Utilities) to recall the characterization file from a disk. In addition, each AutoCal module can be re-characterized using the VNA. A valid 12-term calibration must be active, which is used to characterize the standards within the module.

**10-5** PHYSICAL SETUP

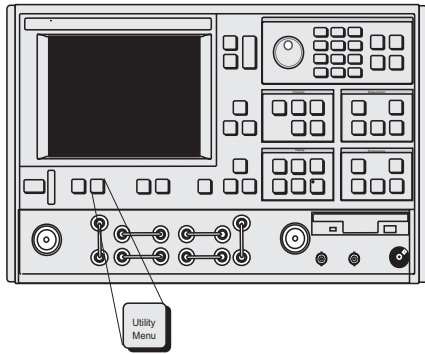
See Figure 10-2 for an illustration of the connections necessary to perform an automatic calibration using the AutoCal module. Note that the connection is very simple. Different power cable connectors are used with the mechanical modules and the electronic modules to prevent connecting the wrong power supply in error.

There is no on-off switch. When power is connected to the AutoCal module, the LED labeled POWER should come on immediately. The second LED, labeled OPERATE, should come on in about five minutes, after the internal temperature control oven has stabilized. The internal temperature is held within a 5 °C window.



**Figure 10-2.** AutoCal Equipment Setup

**10-6 CHARACTERIZATION FILES**



Before performing an AutoCal on a 37XXxD, the Characterization File for the AutoCal Module has to be loaded. This file may be recalled from the floppy disk accompanying the Module. It may also be recalled from one generated using the user's specialized manual calibration.

Insert the AutoCal Module Characterization Disk into the floppy drive. Press the Utility Menu key (left), then select the following menu options, in turn: **AUTOCAL UTILITIES, RECALL FROM FLOPPY DISK.** Select the file "**Lxxxxxxx.ACD**".

If a copy of the Characterization File is in the hard-disk, you can recall it by choosing **RECALL FROM HARD DISK** instead. Select the same file "**Lxxxxxxx.ACD**".

**NOTE**

The "xxxxxx" in the above paragraphs correspond to the serial number of the AutoCal module.

Should you desire to re-characterize the module, which is recommended every six months of usage, perform the following procedure:

**Step 1.** Using a 365x or 375x Calibration Kit, perform a 12-Term calibration over the desired frequency range of characterization, but within the range of the AutoCal module and the VNA.

**NOTE**

Any calibration method may be used (Standard, Offset Short, LRL/LRM, or TRM) along with either the Coaxial or Waveguide line types.

**Step 2.** Upon completion of the calibration, press the Utility Menu key.

MENU UTIL
SELECT UTILITY FUNCTION OPTIONS
GPIB ADDRESSES
DISPLAY INSTRUMENT STATE PARAMS
<b>GENERAL DISK UTILITIES</b>
CAL COMPONENT UTILITIES
<b>AUTOCAL UTILITIES</b>
COLOR CONFIGURATION
DATA ON (OFF) DRAWING
BLANKING FREQUENCY INFORMATION
SET DATE/TIME
PRESS <ENTER> TO SELECT OR TURN ON/OFF

**Step 3.** Select **AUTOCAL UTILITIES** then **AUTOCAL CHARACTERIZATION**, from the next menu to appear.

```

AUTOCAL
CHARACTERIZATION
SWITCH AVERAGING
XXXX
PORT CONFIG
L=1, R=2
R=1, L=2
NUMBER OF
AVERAGES
REFLECTION
XXXX
LOAD
XXXX
THRU
XXXX
ISOLATION
XXXX
START AUTOCAL
CHARACTERIZATION
PRESS <ENTER>
TO SELECT
OR SWITCH
    
```

```

AUTOCAL
UTILITIES
AUTOCAL
CHARACTERIZATION
SAVE
TO HARD DISK
SAVE
TO FLOPPY DISK
RECALL
FROM HARD DISK
RECALL
FROM FLOPPY DISK
PRESS <ENTER>
TO SELECT
    
```

**Step 4.** Select an appropriate amount of **SWITCH AVERAGING** (recommend 4 for the electronic modules, and 16 for the electro-mechanical modules).

**Step 5.** Ensure the Module Configuration is correct (**L=1, R=2** or **R=1, L=2**).

**Step 6.** If desired, you may change the amount of averaging during characterization of each standard, by entering the **NUMBER OF AVERAGES**.

**Step 7.** Ensure the Autocal Module is connected between the Test Ports, power is applied, and the serial cable is connected to the VNA. Verify that both the "Power" and "Operate" LED's are ON.

**Step 8.** Select **START AUTOCAL CHARACTERIZATION**. The VNA will proceed through a characterization of the attached Autocal Module.

**Step 9.** When the calibration is complete, press the Save/Recall key.

**Step 10.** Select **SAVE** then **FRONT PANEL SETUP AND CAL DATA TO HARD DISK** (middle and bottom left).

**Step 11.** Select a file or **CREATE NEW FILE** and press Enter.

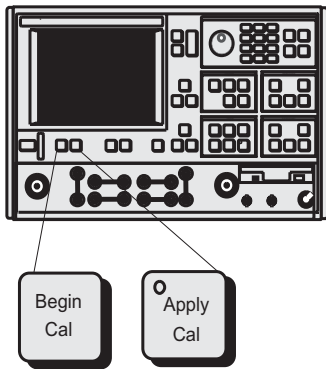
If you are creating a new file, enter the filename and select **DONE** when finished.

**10-7 USING AUTOCAL**

An example procedure for using the **AutoCal** module is given below. This example assumes a frequency range of 40 MHz to 40 GHz, a power level of -7 dBm, and use of a Series 36582 **AutoCal** module.

**Step 1.** Press the Begin Cal key (top left).

**Step 2.** Select **AUTOCAL** from the displayed menu (C11, left).



```

MENU C11
-----
BEGIN CALIBRATION
KEEP EXISTING
CAL DATA
REPEAT
PREVIOUS CAL
AUTOCAL
CAL METHOD
XXXXXXXXXX
TRANSMISSION
LINE TYPE:
XXXXXXXXXX
CHANGE CAL
METHOD AND
LINE TYPE
NEXT CAL STEP
PRESS <ENTER>
TO SELECT
  
```

MENU ACAL
AUTO CAL
AUTO CAL TYPE: XXXXXXXX
<b>CHANGE AUTO CAL SETUP</b>
START AUTO CAL
THRU UPDATE
CONNECT THROUGH LINE BETWEEN PORTS 1 AND 2
NUMBER OF AVGS XXX
START THRU UPDATE
USE PREVIOUS AUTO CAL SETUP
PRESS <ENTER> TO SELECT OR SWITCH

**Step 3.**

The selections in the next menu to appear, MENU ACAL, will depend on current instrument conditions, as follows:

- a. **THRU UPDATE** lets you update the Thru calibration of an active 12-term Calibration. This updates the transmission frequency response and load match coefficients.
- b. **START AUTO CAL** lets you start a calibration using the current setup.
- c. **CHANGE AUTO CAL SETUP** lets you set up a new calibration, which is what we will do for this example. This example also assumes that you have selected the transmission medium and, if waveguide, identified the cutoff frequency.



MENU ACAL_SETUP
AUTOCAL SETUP
LINE TYPE COAXIAL/WAVEGUIDE
WAVEGUIDE CUTOFF XX.XXXXXX GHz
SWITCH AVERAGING 8
NUMBER OF AVGS
REFLECTION XXXX
LOAD XXXX
THRU XXXX
ISOLATION XXXX
AUTOCAL TYPE
S11 1 PORT S22 1 PORT FULL 2 PORT ADAPTER REMOVAL

**Step 4.**

Select **CHANGE AUTOCAL SETUP**. This causes MENU ACAL\_SETUP (left) to appear.

**Step 5.**

Enter a **SWITCH AVERAGING** value of **8**.

To improve the effect of switch repeatability error with the 36582 series (mechanical switch), you can change the switch averaging. Note, however, that switch averaging will have no effect on the 36581 series (electronic switch).

**Step 6.**

Select **FULL 2 PORT**. This displays a menu (MENU ACAL\_FULL) that lets you set up the calibration (bottom left).

You could have also selected **S11 1-PORT, S22 1-PORT, or ADAPTER REMOVAL**. The last of these lets you remove the effects of an adapter used in the calibration.

**Step 7.**

Select the **PORT CONFIG** setting that matches the physical setup (**R=1, L=2 or L=1, R=2**).

It is critical to ensure the correct module orientation is established. Each side (left) and right) of the module is labeled.

**Step 8.**

Select the **THRU TYPE** to be either **CALIBRATOR** or **TRUE**.

By default, the **CALIBRATOR** (internal) thru standard is used for the Thru Calibration. The transmission response of the calibration may be improved by selecting the **TRUE** thru standard. This will result in an added manual step.

**Step 9.**

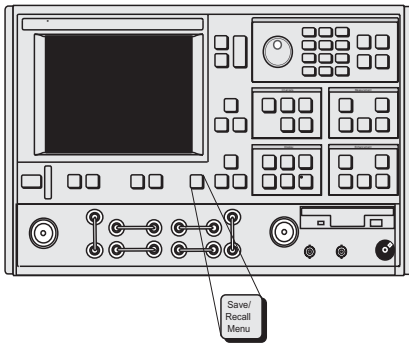
Observe that **OMIT** is shown for the **ISOLATION AVERAGING**.

Isolation may be omitted (default). You may also select **DEFAULT** to use the default value during the isolation step. You may also use your own **AVERAGING FACTOR**. Including isolation involves a manual step for the 36581 models.

**Step 10.**

Ensure the AutoCal module is properly connected between Ports 1 and 2, then select **START AUTOCAL**.

MENU ACAL_FULL
AUTOCAL FULL 2-PORT
ISOLATION AVERAGING
OMIT
DEFAULT
AVERAGING FACTOR XXXX
THRU TYPE CALIBRATOR/TRUE
PORT CONFIG L=1, R=2 R=1, L=2
START AUTOCAL
PRESS <ENTER> TO SELECT OR SWITCH



**Step 11.**

Follow the on-screen instructions and do not disturb the setup during the calibration. Please note that you should not start a calibration until both LED's on the AutoCal module are lit. This will ensure accurate calibration of the VNA.

**Step 12.**

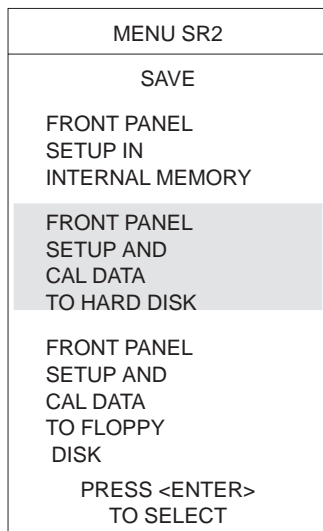
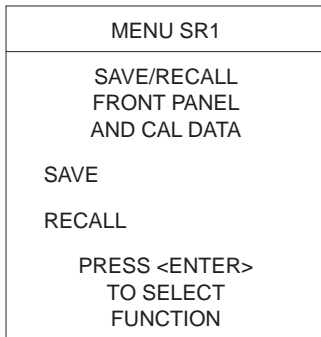
When the calibration is complete, press the Save/Recall key.

Select **SAVE** then **FRONT PANEL SETUP AND CAL DATA TO HARD DISK** (middle and bottom left).

**Step 13.**

Select a file or **CREATE NEW FILE** and press Enter.

If you are creating a new file, enter the filename and select **DONE** when finished.



**10-8 PIN DEPTH SPECIFICATIONS**

The depth of the center pin on connectors is a critical specification, which if not met, can cause damage to mating connectors. Table 10-1 provides pin depth examples and Table 10-2 provides pin-depth specifications for associated **AutoCal** connectors.

**Table 10-1. Checking Connector Pin Depth (Example)**

<i>Example 1:</i>		
<b>FEMALE MASTER GAUGE BLOCK (protrusion)</b>		
	Desired nominal value:	0.2070
<b>Case1</b>	Actual value of master gauge	0.2071 (protrusions 0.0001 more than desired)
	Gauge should be set to indicate:	+0.0001
<b>Case2</b>	Actual value of master gauge	0.2069 (protrusions 0.0001 less than desired)
	Gauge should be set to indicate:	-0.0001
<i>Example 2:</i>		
<b>MALE MASTER GAUGE BLOCK (cavity)</b>		
	Desired nominal value:	0.2070
<b>Case1</b>	Actual value of master gauge	0.2071 (cavity 0.0001 deeper than desired)
	Gauge should be set to indicate:	-0.0001
<b>Case2</b>	Actual value of master gauge	0.2069 (cavity 0.0001 shallower than desired)
	Gauge should be set to indicate:	+0.0001

**Table 10-2. AutoCal Module Connector Pin Depth Specifications**

Device	Connector	Pin Depth (inches)
3658XXX	K-Female	+0.0000 to -0.005
3658XXX	K-Male	+0.0000 to -0.005
3658XXX	N-Female	*[0.207](+0.000, -0.005)
3658XXX	K-Female	*[0.207](+0.000, -0.005)
32K50 32KF50	K-Male (cable side)	**Negative Indication
	K-Female	+0.0000 to -0.0005
	K-Male (DUT side)	+0.0000 to -0.0005
32L50 32LF50	K-Male (cable side)	**Negative Indication
	3.5mm-Female (DUT side)	+0.006 to -0.008
	3.5mm-Male (DUT side)	+0.006 to -0.008
32S50 32SF50	K-Male (cable side)	**Negative Indication
	SMA-Female (DUT side)	+0.0005 to -0.0015
	SMA-Male (DUT side)	+0.0005 to -0.0015

\*Gauging Type N Connectors: The actual value of a Type N master gauge block will always vary to some degree from the desired nominal value. The recorded measured value of the master gauge must be observed when calibrating the Pin Depth Gauge to the desired nominal value. Although the **AutoCal** Module Pin Depths are not critical, this information may be helpful in the measurement of Type N mating components. Examples are shown in Table 10-1, on the preceding page.

**10-9** AUTOCAL MENUS FLOW DIAGRAM

A flow diagram for the AutoCal menus is provided in Figure 10-3.

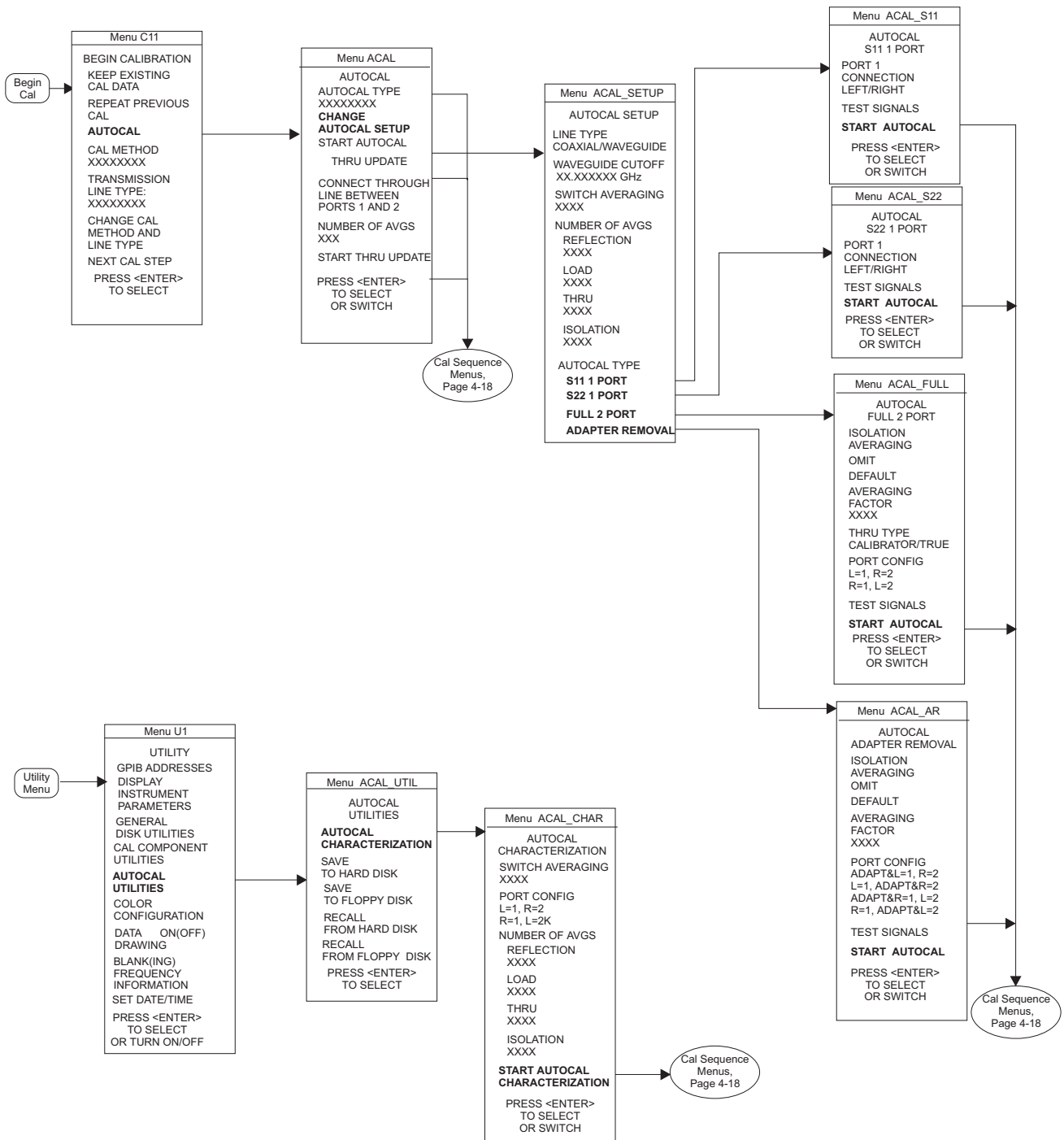


Figure 10-3. AutoCal Menus Flow Diagram

# **Chapter 11**

## **Operational Checkout Procedures**

### **Table of Contents**

---

11-1	INTRODUCTION. . . . .	11-3
11-2	REQUIRED EQUIPMENT. . . . .	11-3
11-3	INITIAL SETUP . . . . .	11-3
11-4	SELF TEST . . . . .	11-3
11-5	NON-RATIO POWER . . . . .	11-4
11-6	HIGH LEVEL NOISE TEST . . . . .	11-6

Repair



---

**WARNING**

---

This equipment can not be repaired by the operator. DO NOT attempt to remove the equipment covers or to disassemble internal components. Only qualified service technicians with a knowledge of electrical fire and shock hazards should service this equipment. There are high-voltage parts in this equipment presenting a risk of severe injury or fatal electric shock to untrained personnel. In addition, there is a risk of damage to precision components.

---

# Chapter 11

## Operational Checkout Procedures

### 11-1 INTRODUCTION

This chapter provides quick operational checkout procedures that may be used by incoming inspectors to ensure that the Model 37XXXD Vector Network Analyzer is operational. This is a quick-check procedure. For the full performance verification procedure, refer to the Series 37XXXD Maintenance Manual, Anritsu Part Number 10410-00264.

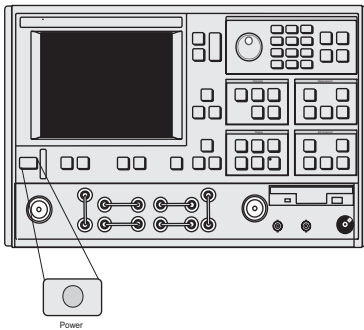
### 11-2 REQUIRED EQUIPMENT

The following equipment is required for the procedures in this chapter:

- Flexible microwave cable (through line)
- Short

### 11-3 INITIAL SETUP

Before starting the performance tests, press the Power key (left) to On.

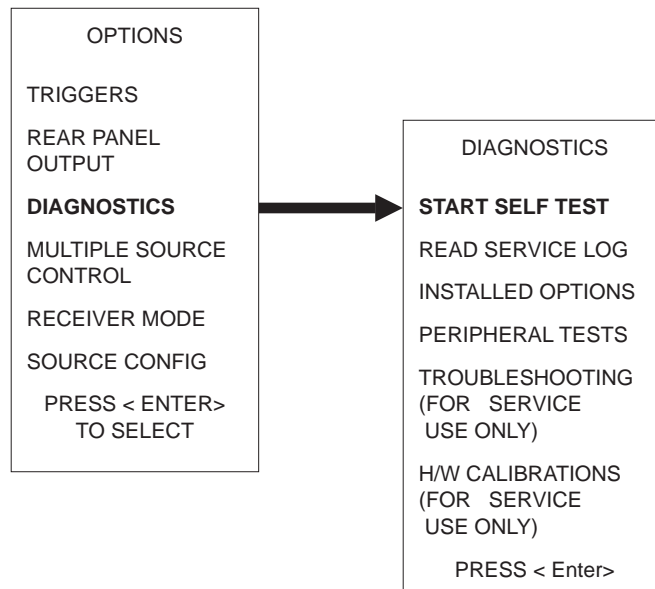


#### **NOTE**

Allow the system to warm up for at least 60 minutes to ensure operation to performance specifications.

### 11-4 SELF TEST

Perform an instrument self test to ensure that the VNA is operating properly. To start a self test, Press the Option Menu key and make the menu choices shown in Figure 11-1.

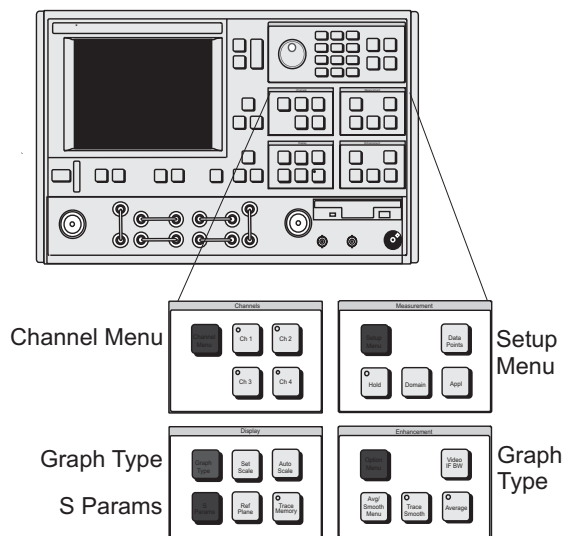


**Figure 11-1.** Performing a Self Test

**11-5 NON-RATIO POWER**

This test verifies that each individual receiver channel operates properly. Measurement calibration of the system is *not* required for this test.

This test requires that you press specified front panel keys and make choices from the displayed menu(s). The keys used in this test are shown below.





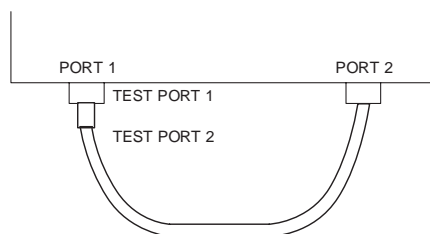
**Test Procedure**

Perform test as described below.

Key	Menu Choice
Options Menu	Non-Ratioed Parameters, see Figure 11-2
Setup Menu	START: 1 GHz STOP: High-End Frequency
Channel Menu	FOUR CHANNELS
Graph Type	LOG MAGNITUDE (All channels)
S-PARAMS	USER 1: (Channel 3) Parameter: Ra/1 Phase Lock: Ra USER 2: (Channel 1) Parameter: Ta/1 Phase Lock: Ra USER 3: (Channel 2) Parameter: Tb/1 Phase Lock: Ra USER 4: (Channel 4) Parameter: Rb/1 Phase Lock: Rb
SET SCALE	RESOLUTION: 20 dB/DIV REF VALUE: 0 dB (All four channels)

**Step 1.**

Connect Test Ports 1 and 2 together using a high-quality through line (below).



**Step 2.**

Reset the VNA using the Default Program key.

**Step 3.**

Set up the VNA as shown in table at left.

**Step 4.**

Observe the sweep indicators and allow at least one complete sweep to occur on all four channels.

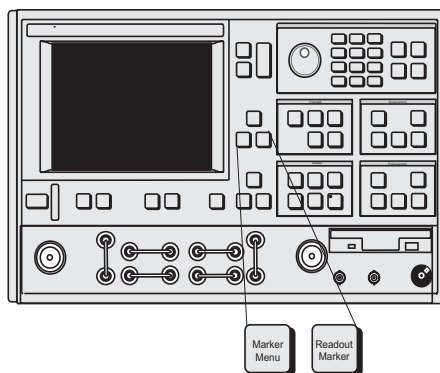
**Step 5.**

Verify that the minimum amplitude meets the specifications shown below.

Model	Test Channel	Reference Channel
37217C	>-28 dB	>-35 dB
37317C	>-28 dB	>-35 dB
37225C	>-25 dB	>-34 dB
37325C	>-30 dB	>-32 dB
37247C	>-26 dB	>-35 dB
37347C	>-31 dB	>-33 dB
37269C	>-40 dB	>-40 dB
37369C	>-34 dB	>-34 dB
37277C	>-45 dB	>-45 dB
37377C	>-45 dB	>-45 dB
37297C	>-60 dB	>-55 dB
37397C	>-60 dB	>-55 dB

**NOTE**

Use the Marker Menu and Readout Marker keys ( left) and menus to obtain precise frequency and amplitude values.

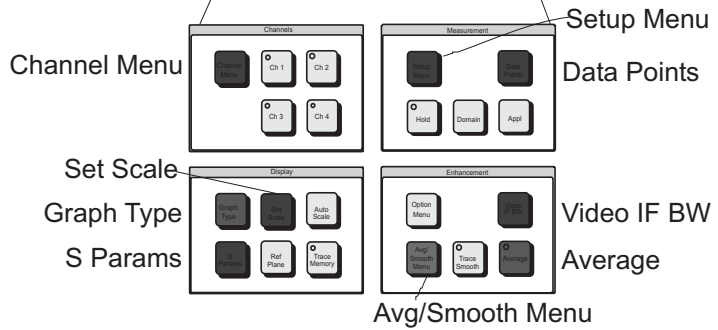
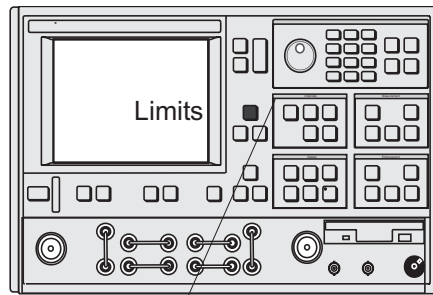


**11-6 HIGH LEVEL NOISE TEST**

The following test verifies that the high-level signal noise in the VNA will not significantly affect the accuracy of subsequent measurements. Calibration of the system is *not* required for this test.

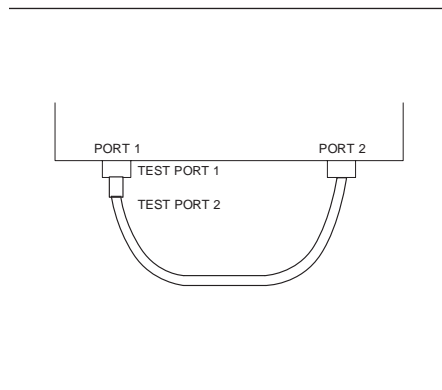
This test requires that you press specified front panel keys and make choices from the displayed menu(s). The keys used in this test are highlighted below.

Key	Menu Choice
Setup Menu	START: 40 MHz STOP: High-end frequency
Channel Menu	DUAL CHANNELS 1-3
Graph Type	LOG MAGNITUDE (Both channels)
Set Scale	RESOLUTION: 0.020 dB/DIV REF VALUE: 0.0 dB (Both channels)
S-Params	Channel 1 – S12 Channel 3 – S21
Data Points	201
Video IF BW	NORMAL (1 kHz)
Limits	UPPER LIMIT ON 0.015 if less than 40 GHz 0.04 if 40 GHz 0.14 if above 40 GHz  LOWER LIMIT ON -0.015 if less than 40 GHz -0.04 if 40 GHz -0.14 if above 40 GHz  DISPLAY LIMITS ON

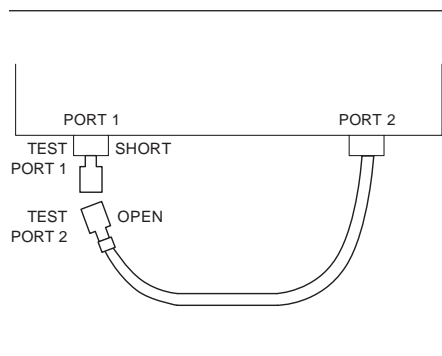


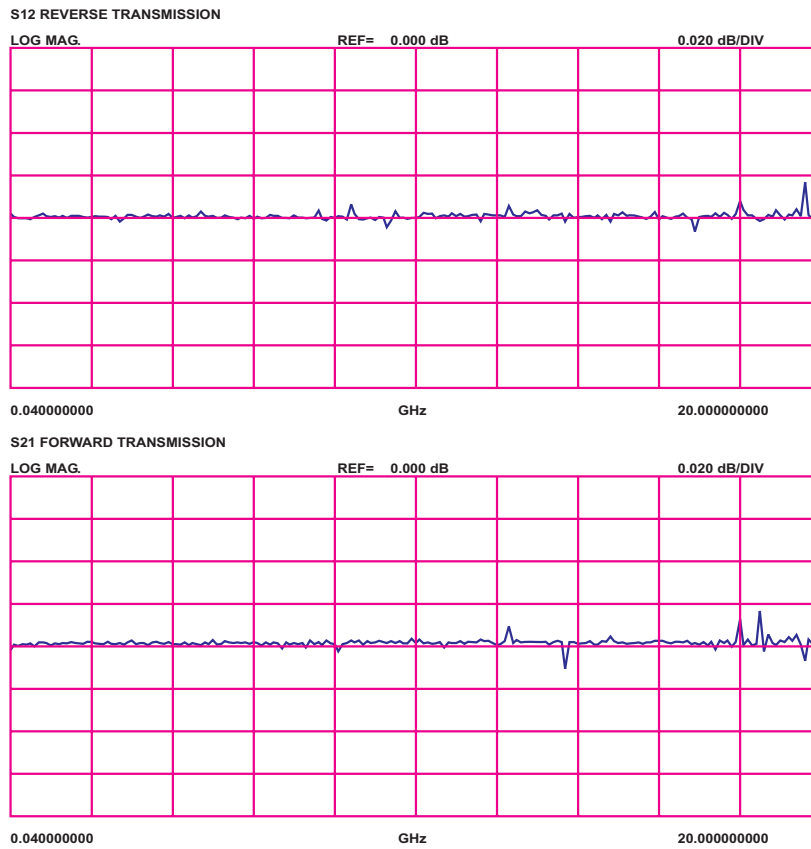
Setup the VNA as described in the table at the left.

Perform the test as described below:



- Step 1.** Reset the VNA using the Default Program key.
- Step 2.** Connect Test Port 1 and Test Port 2 (top left) together.
- Step 3.** Press the Ch 1 key.
- Step 4.** Press the Trace Memory key.
- Step 5.** Choose **VIEW DATA** from the menu and press the Enter key.
- Step 6.** While observing the sweep indicators, allow at least two complete sweeps to occur.
- Step 7.** Choose **STORE DATA TO MEMORY** from the menu and press the Enter key.
- Step 8.** Choose **VIEW DATA / MEMORY** from the menu and press the Enter key.
- Step 9.** While observing the sweep indicators, allow at least two complete sweeps to occur.
- Step 10.** Verify that the peak-to-peak High Level Noise falls within the area between the two limit lines (Figure 11-2, following page).
- Step 11.** Press the Ch 3 key.
- Step 12.** Repeat Steps 4 through 9 for channel 3.
- Step 13.** Press the S Params key; set Ch 1 for S<sub>11</sub> and Ch 3 for S<sub>22</sub>.
- Step 14.** Connect a Short to Test Port 1 and an Open to Test Port 2 (left).
- Step 15.** Repeat Steps 2 through 9.





**Figure 11-2.** High Level Noise Test Waveform

# Chapter 12

## Calibration Kits

### Table of Contents

---

12-1	INTRODUCTION . . . . .	12-3
12-2	PURPOSE. . . . .	12-3
12-3	KIT CONTENTS . . . . .	12-3
	Model 3650 Calibration Kit . . . . .	12-4
	Model 3651 Calibration Kit . . . . .	12-5
	Model 3652 Calibration Kit . . . . .	12-6
	Model 3653 Calibration Kit . . . . .	12-7
	Model 3654/ 3654C Calibration Kit . . . . .	12-8
	Model 3656 Calibration Kit . . . . .	12-9
	Model 3657 Calibration Kit . . . . .	12-10
12-4	PRECAUTIONS . . . . .	12-11
	Pin Depth . . . . .	12-11
	Pin Depth Tolerance . . . . .	12-12
	Over Torquing Connectors . . . . .	12-12
	Teflon Tuning Washers. . . . .	12-12
	Mechanical Shock . . . . .	12-12
12-5	CLEANING INSTRUCTIONS . . . . .	12-13



# **Chapter 12**

## **Calibration Kits**

### **12-1 INTRODUCTION**

This chapter provides illustrations and contents for the Models 3650, 3651, 3652, 3653, 3654C, 3657, 36550 and 36552 Calibration Kits.

### **12-2 PURPOSE**

The calibration kits contain all of the precision components and tools required to calibrate the 37XXXD Vector Network Analyzer System for a 12-term error-corrected measurement.

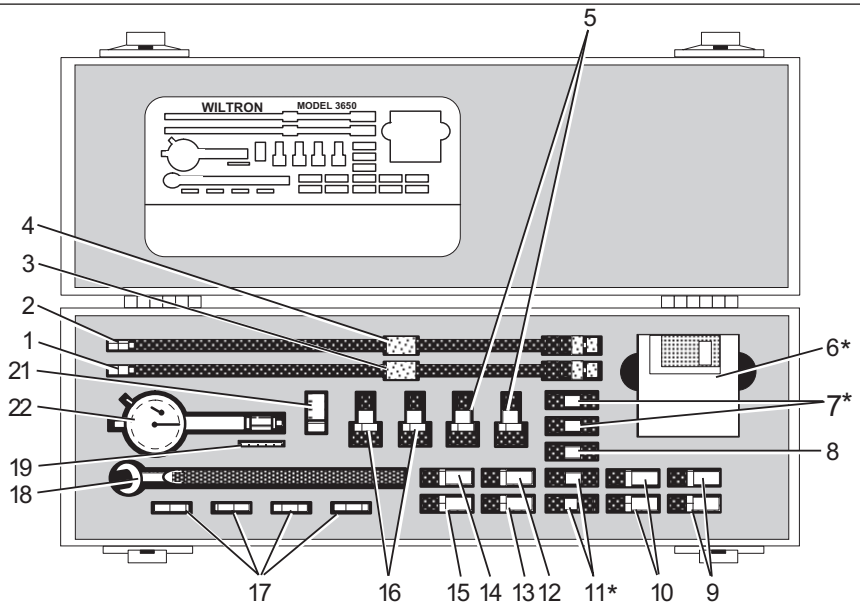
### **12-3 KIT CONTENTS**

The contents and illustrations of the calibration kits are listed on the following pages.

**Model 3650 Calibration Kit**

**Table 12-1.** Model 3650 (SMA/3.5 mm) Calibration Kit Contents

Index	Anritsu Part Number	Description	Qty.
1	01-212	Female Flush Short (Option 1)	1
2	01-211	Male Flush Short (Option 1)	1
3	17SF50	Female Sliding Termination	1
4	17S50	Male Sliding Termination (Option 1)	1
5	34ASF50-2	Female Adapter	2
6		Calibration Software Diskette	1
7	33FSF50	Female-Female Adapter	2
8	33SS50	Male-Male Adapter*	1
9	28S50-2	Male Termination	2
10	28SF50-2	Broadband Female Termination	2
11	33SSF50	Male-Female Adapter*	2
12	24S50	Male Open	1
13	23SF50	Female Open	1
14	23S50	Male Short	1
15	23SF50	Female Short	1
16	34AS50-2	Male Adapter	2
17		Connector Thumb Wheel	4
18	01-201	Torque Wrench	1
19	01-210	Reference Flat	1
20	01-222	Pin Depth Gauge	1
21	01-223	Pin Depth Gauge	1



**Figure 12-1.** Model 3650 (SMA/3.5 mm) Calibration Kit Components

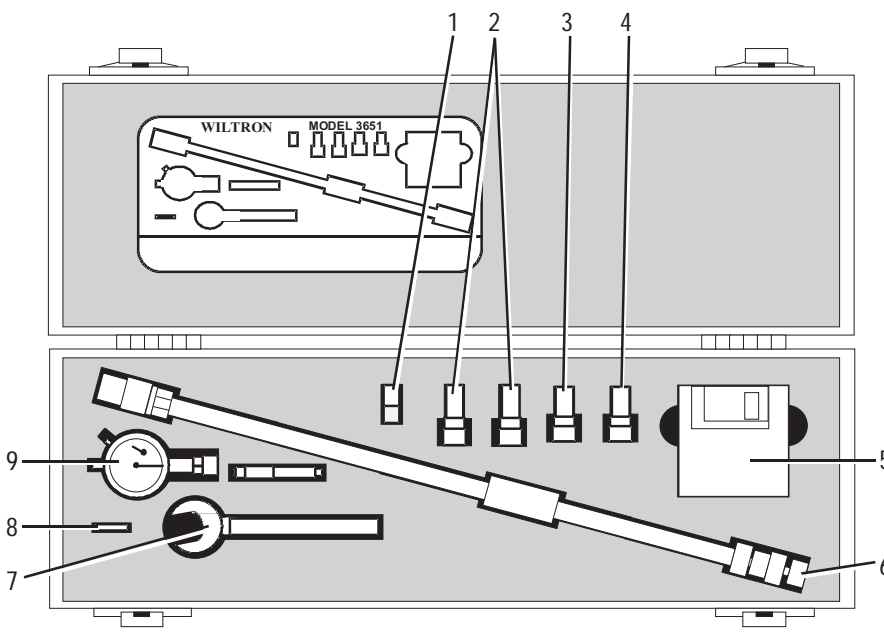
\* Phase Equal Adapters



**Model 3651 Calibration Kit**

**Table 12-2.** Model 3651 (GPC-7) Calibration Kit Contents

Index	Anritsu Part Number	Description	Qty.
1	01-221	Collet and Extractor Tool	1
2	28A50-2	Broadband Termination	2
3	24A50	Open	1
4	23A50	Short	1
5		Calibration Software Diskette	1
6	17A50	Sliding Termination (Option 1)	1
7	01-200	Torque Wrench	1
8	01-210	Reference Flat	1
9	01-220	Pin Depth Gauge	1

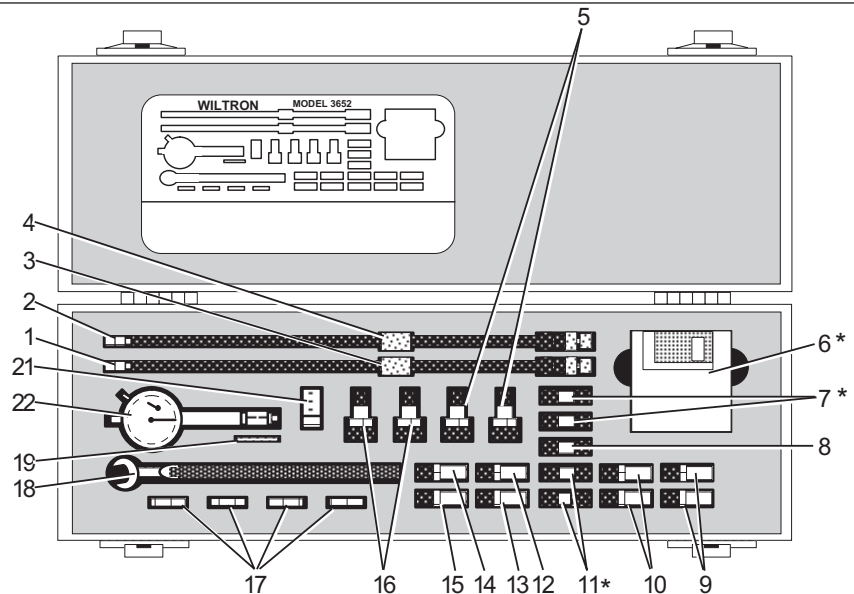


**Figure 12-2.** Model 3651 (GPC-7) Calibration Kit Components

**Model 3652 Calibration Kit**

**Table 12-3.** Model 3652 (K-Connector) Calibration Kit Contents

Index	Anritsu Part Number	Description	Qty.
1	01-212	Female Flush Short (Option 1)	1
2	01-211	Male Flush Short (Option 1)	1
3	17KF50	Female Sliding Termination	1
4	17K50	Male Sliding Termination (Option 1)	1
5	34AKF50-2	Female Adapter	2
6		Calibration Software Diskette	1
7	33FKF50	Female-Female Adapter	2
8	33KK50	Male-Male Adapter*	1
9	28K50-2	Male Termination	2
10	28KF50-2	Broadband Female Termination	2
11	33KKF50	Male-Female Adapter*	2
12	24K50	Male Open	1
13	23KF50	Female Open	1
14	23K50	Male Short	1
15	23KF50	Female Short	1
16	34AK50-2	Male Adapter	2
17		Connector Thumb Wheel	4
18	01-201	Torque Wrench	1
19	01-210	Reference Flat	1
20	01-222	Pin Depth Gauge	1
21	01-223	Pin Depth Gauge	1



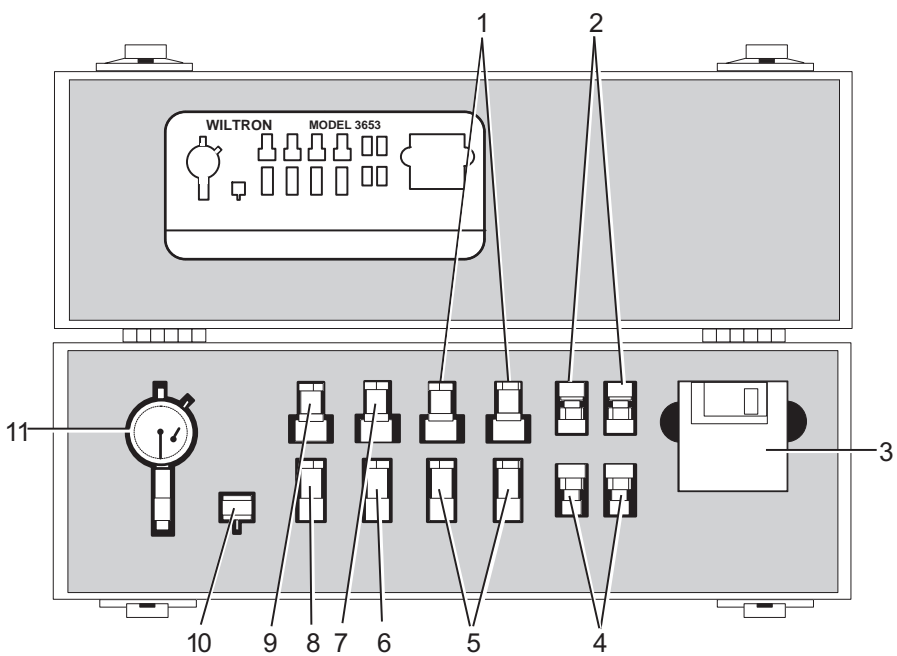
**Figure 12-3.** Model 3652 (K-Connector) Calibration Kit Components

\* Phase Equal Adapters

**Model 3653 Calibration Kit**

**Table 12-4.** Model 3653 (Type N) Calibration Kit Contents

Index	Anritsu Part Number	Description	Qty.
1	28N50-2	Broadband Male Termination	2
2	34AN50-2	Male Adapter	2
3		Calibration Software Diskette	1
4	34ANF50-2	Female Adapter	2
5	28NF50-2B	Braodband Female Termination	2
6	24NF50	Female Open	1
7	24N50	Male Open	1
8	23NF50	Female Short	1
9	23N50	Male Short	1
10	01-213	Reference Gauge	1
11	01-224	Pin Depth Gauge	1

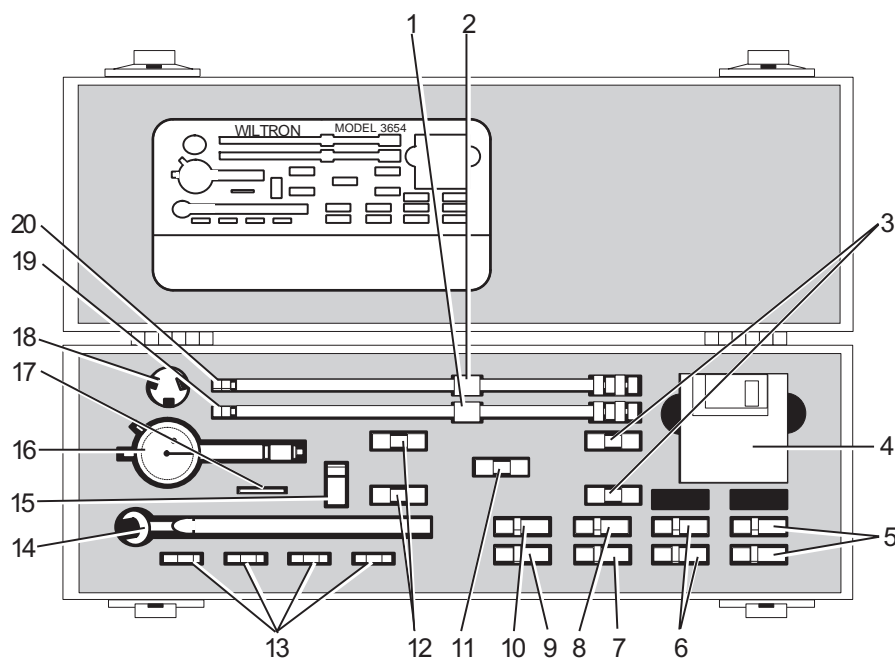


**Figure 12-4.** Model 3653 (Type N) Calibration Kit Components

**Model 3654C Calibration Kit**

**Table 12-5.** Model 3654C/3654C-1 (V-Connector) Calibration Kit Contents

Index	Anritsu Part Number	Description	Qty.
1	17VF50B	Female Sliding Termination (3654C-1 only)	1
2	17V50B	Male Sliding Termination (3654C-1 only)	1
3	33VVF50	Male-Female Adapter	2
4	2360-54B	Calibration Software Diskette	1
5	28V50C	Male Broadband Termination	2
6	28VF50C	Female Broadband Termination	2
7	24V50B	Male Open	1
8	24VF50B	Female Open	1
9	23V50B-5.1	Male Short, 5.1 mm	1
10	23VF50B-5.1	Female Short, 5.1 mm	1
11	33VV50	Male-Male Adapter	1
12	33VVFV50	Female-Female Adapter	2
13		Connector Thumb Wheel	4
14	01-201	Torque Wrench	1
15	01-323	Female Adapter For Pin Gauge	1
16	01-322	Pin Depth Gauge	1
17	01-210	Reference Flat	1
18	01-204	Adapter Wrench	1
19	01-312	Male Flush Short	1
20	01-311	Female Flush Short	1



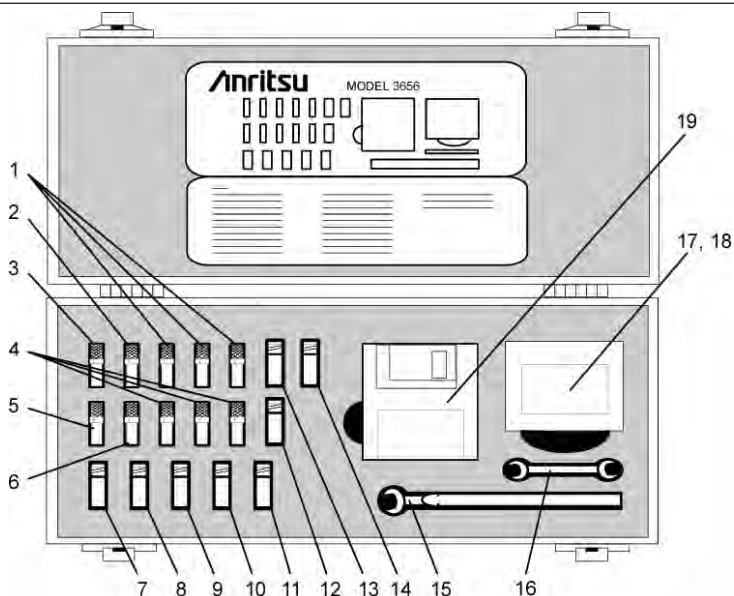
**Figure 12-5.** Model 3654 (V-Connector) Calibration Kit Components

\* Phase Equal Adapters

**Model 3656 Calibration Kit**

**Table 12-6.** Model 3656 (W1-Connector) Calibration Kit Contents

Index	Anritsu Part Number	Description	Qty.
1	23W50-1	Male Offset Short 1 (2.02 mm)	1
	23W50-2	Male Offset Short 2 (2.65 mm)	1
	23W50-3	Male Offset Short 3 (3.180 mm)	1
2	24W50	Male Open (1.510 mm)	1
3	28W50	Male Broadband Termination	1
4	23WF50-1	Female Offset Short 1 (2.02 mm)	1
	23WF50-2	Female Offset Short 2 (2.65 mm)	1
	23WF50-3	Female Offset Short 3 (3.180 mm)	1
5	28WF50	Female Broadband Termination	1
6	24WF50	Female Open (1.930 mm)	1
7	33WSC50	Fixed Male SC Connector	1
8	33WFSC50	Fixed Female SC Connector	1
9		Interchangeable Sliders, SC Connectors	1
10		Locking Keys, SC Connectors	1
11	01-402	Interchangeable Adapter Fixed Male	1
12	33WWF50	Male-Female Adapter	1
13	33WW50	Male-Male Adapter	1
14	33WFWF50	Female-Female Adapter	1
15	01-504	6 mm Torque Wrench	1
16	01-505	6x7 mm End Wrench	1
17	18-WWF50-1B	Stepped Impedance ThruLine (Verification Device)	1
18	18-WWF50-1	50Ω Matched ThruLine (Verification Device)	1
19		Calibration/Verification Software	

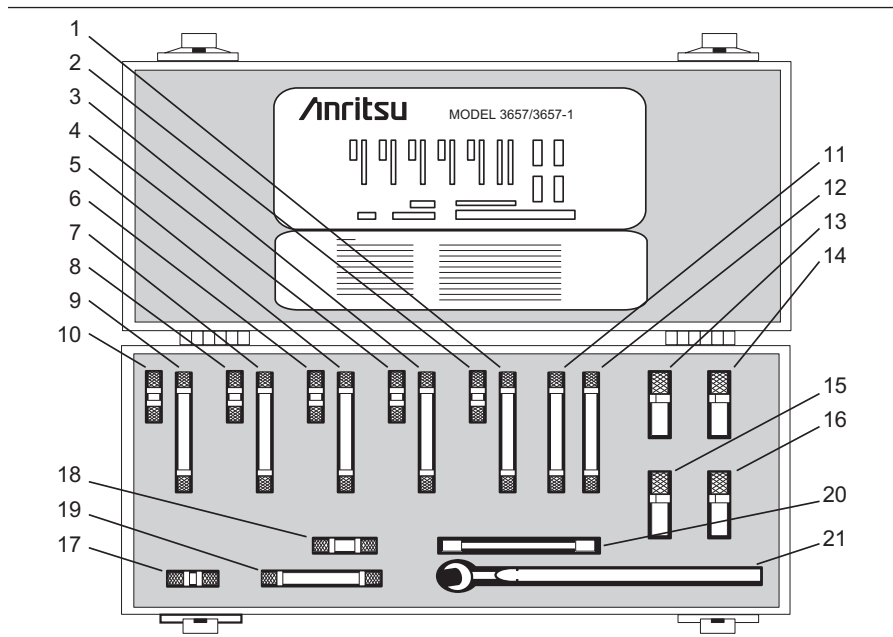


**Figure 12-6.** Model 3656 (W1-Connector) Calibration Kit Components

**Model 3657 Calibration Kit**

**Table 12-7.** Model 3657/3657-1 (Multiple Line) Calibration Kit Contents

Index	Anritsu Part Number	Description	Qty.
1	65898-1	15.00 mm V-LRL MALE-MALE, Outer Conductor	1
2	65899-1	15.00 mm V-LRL MALE-MALE, Center Conductor	1
3	65898-2	16.70 mm V-LRL MALE-MALE, Outer Conductor	1
4	65899-2	16.70 mm V-LRL MALE-MALE, Center Conductor	1
5	65898-3	18.40 mm V-LRL MALE-MALE, Outer Conductor	1
6	65899-3	18.40 mm V-LRL MALE-MALE, Center Conductor	1
7	65898-4	20.10 mm V-LRL MALE-MALE, Outer Conductor	1
8	65899-4	20.10 mm V-LRL MALE-MALE, Center Conductor	1
9	65898-5	21.80 mm V-LRL MALE-MALE, Outer Conductor	1
10	65899-5	21.80 mm V-LRL MALE-MALE, Center Conductor	1
11	65898-6	49.84 mm V-LRL MALE-MALE, Outer Conductor	1
12	65899-6	49.84 mm V-LRL MALE-MALE, Center Conductor	1
13, 14	23V50B-5.1	5.1 mm Male Short (3657-1 Only)	2
15, 16	23VF50B-5.1	5.1 mm Female Short (3657-1 Only)	2
17	65922	Center Conductor Removal Plug	1
18	65901-1	Center Conductor Installation/Removal Fixture	1
19	65901-6	Center Conductor Installation/Removal Fixture	1
20	783-1243	End Wrench	1
21	01-201	Torque Wrench, 8 in/lbs	1



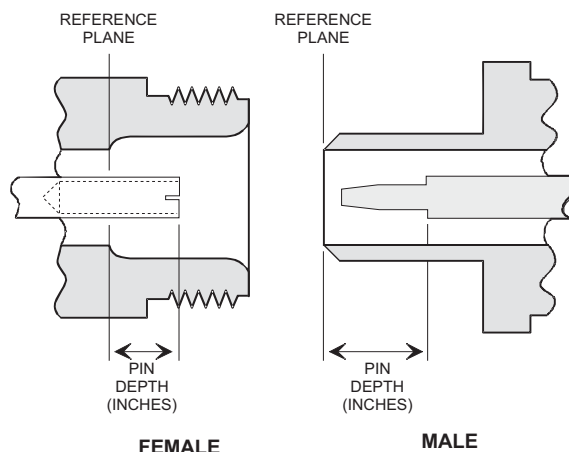
**Figure 12-7.** Model 3657 (Multiple Line) Calibration Kit Components

**12-4 PRECAUTIONS**

The following are precautionary notes related to the use of connectors. For specific information on setting pin depths on sliding terminations, refer to the 37XXXD Operation Manual, Chapter 7.

***Pin Depth***

Before mating, measure the pin depth (Figure 12-7) of the device that will mate with the RF component, using an Anritsu Pin Depth Gauge or equivalent (Figure 12-8). Based on RF components returned for repair, destructive pin depth of mating connectors is the major cause of failure in the field. When an RF component is mated with a connector having a destructive pin depth, damage will likely occur to the RF component connector. (A destructive pin depth has a center pin that is too long in respect to the connector's reference plane.)

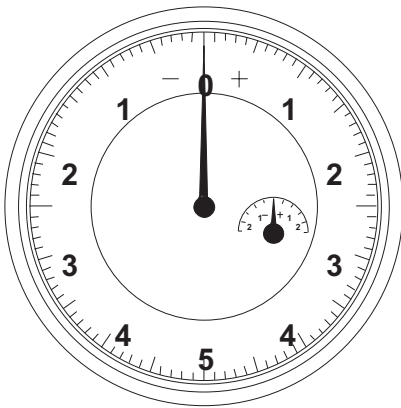


**Figure 12-8.** N-Connector Pin Depth

**Pin Depth Tolerance**

The center pin of RF component connectors has a precision tolerance measured in mils (1/1000 inch). Connectors on test devices that mate with RF components may not be precision types and may not have the proper depth. They must be measured before mating to ensure suitability. When gauging pin depth, if the test device connector measures out of tolerance (Table 12-7) in the “+” region of the gauge (Figure 12-8), the center pin is too long. Mating under this condition will likely damage the termination connector. On the other hand, if the test device connector measures out of tolerance in the “-” region, the center pin is too short. While this will not cause any damage, it will result in a poor connection and a consequent degradation in performance.

**Table 12-8.** Pin Depth Tolerances



**Figure 12-9.** Pin Depth Gauge

Port/Connector Type	Pin Depth (mils)	Anritsu Gauge Setting
GPC 7	+0.000 to -0.003	Same as pin depth
N Male	.207    +0.003 -0.003	Same as pin depth
N Female		
WSMA Male	-0.0025 -0.0035	Same as pin depth
WSMA Male		
K Male	+0.000 to -0.003	Same as pin depth
K Female		
V Male	+0.000 to -0.001	Same as pin depth
V Female		

**Over Torquing Connectors**

Over torquing connectors is destructive; it may damage the connector center pin. Finger-tight is usually sufficient, especially on Type N connectors. *Never* use pliers to tighten connectors.

**Teflon Tuning Washers**

The center conductor on most RF components contains a small teflon tuning washer located near the point of mating (interface). This washer compensates for minor impedance discontinuities at the interface. The washer’s location is critical to the RF component’s performance. *Do not disturb it.*

**Mechanical Shock**

RF components are designed to withstand years of normal bench handling. However, do not drop or otherwise treat them roughly. They are laboratory-quality devices, and like other such devices, they require careful handling.



**12-5** CLEANING  
INSTRUCTIONS

Connector interfaces—especially the outer conductors on the GPC 7 and SMA connectors—should be kept clean and free of dirt and other debris.

Denatured alcohol applied with a cotton swab applicator is recommended for cleaning connector interfaces.

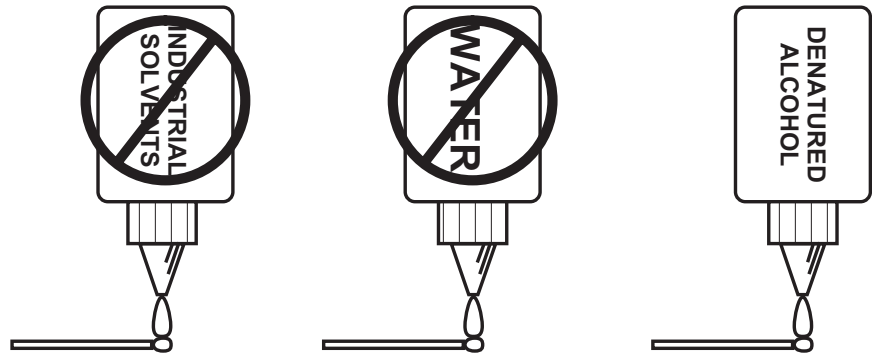
**NOTE**

Most cotton swabs are too large to fit in the smaller connector types. It is necessary to remove most of the cotton and then twist the remaining cotton tight. Be sure that the remaining cotton does not get stuck in the connector.

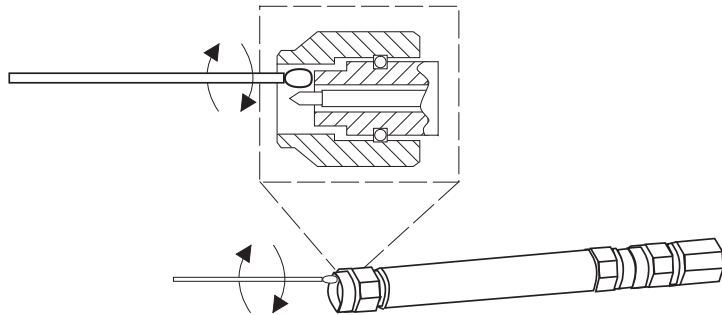
The following are some important tips on cleaning connectors:

- Use only denatured alcohol as a solvent
- Always use an appropriate size of cotton swab
- Gently move the cotton swab around the center conductor
- Never put lateral pressure on the connector's center pin
- Verify that no cotton or other foreign material remains in the connector after cleaning
- Only dampen the cotton swab. Do NOT saturate it
- Compressed air can be used to remove foreign particles and to dry the connector
- Verify that the center pin has not been bent or damaged

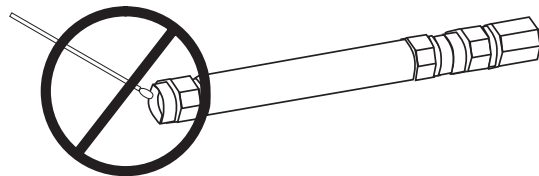
Figure 12-10, following page, illustrates how to clean connectors.



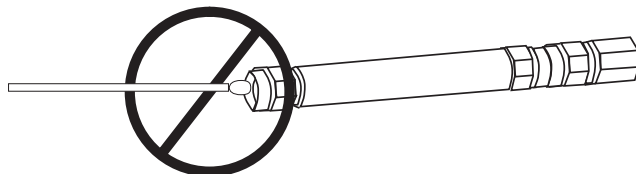
Do NOT use Industrial Solvents or Water on connector. Use only Denatured Alcohol.



Use only denatured alcohol and the proper size of cotton swab. Gently rotate the swab around the center pin being careful not to stress or bend the pin or you will damage the connector.



Do NOT put cotton swabs in at an angle, or you will damage the connectors.



Do NOT use too large of cotton swab, or you will damage the connectors.

**Figure 12-10.** How to Clean Connectors

# **Chapter 13**

## **Millimeter Wave**

### **System**

## **Table of Contents**

---

13-1	INTRODUCTION . . . . .	13-3
13-2	DESCRIPTION . . . . .	13-3
13-3	PERFORMANCE SPECIFICATIONS . . . . .	13-4
	System Performance . . . . .	13-4
	Test Port Characteristics . . . . .	13-5
	Measurement Capabilities . . . . .	13-5
13-4	INSTALLATION . . . . .	13-6
	Console and Table Setup . . . . .	13-7
	Instrument Installation into Console . . . . .	13-8
	System Cabling . . . . .	13-10
13-5	CALIBRATION . . . . .	13-12
13-6	OPERATION . . . . .	13-13
	Entering/ Leaving Millimeter Wave Operation . . . . .	13-13
	Changing Bands/Modules While in Millimeter Wave . . . . .	13-17
	Allowable Millimeter Wave Module Configurations, Measurements and Calibrations. . . . .	13-17
	Effect of Default Program . . . . .	13-18
	Redefinition of Band Frequency Ranges . . . . .	13-19
	Use of Normal Multiple Source Mode . . . . .	13-20
	Stored Setups and Calibrations . . . . .	13-20
	External Source and Power Levels . . . . .	13-21
13-7	MEASUREMENT PROCEDURE. . . . .	13-22
13-8	REMOTE OPERATION. . . . .	13-23
13-9	OPERATIONAL CHECKOUT— GENERAL . . . . .	13-24
13-10	OPERATION CHECKOUT—IF POWER LEVEL TEST . . . . .	13-25

***Table of Contents (Continued)***

---

13-11 OPERATIONAL CHECKOUT— TRANSMISSION HIGH LEVEL NOISE TEST 13-27

13-12 OPERATIONAL CHECKOUT— REFLECTION HIGH LEVEL NOISE TEST . 13-29

# Chapter 13

## Millimeter Wave System

### **13-1** INTRODUCTION

This chapter describes the ME7808C Millimeter Wave System, its operation, and its measurement capabilities. For information on ME7808C Broadband System, refer to Chapter 14.

### **13-2** DESCRIPTION

The ME7808C Millimeter Wave System can be constructed upon any 37XXD VNA, 37247D being the most economical choice. It also requires two 680XXC or MG369XA Frequency Synthesizers, and a 3735B Millimeter Test Set having two 374X Millimeter Wave Modules. There are 14 different 374X modules available (below) to accommodate different measurement types and frequency ranges.

- 3741A-V 50 to 75 GHz Transmission Module
- 3741A-E 60 to 90 GHz Transmission Module
- 3741A-EE56 to 94 GHz Transmission Module
- 3741A-W 75 to 110 GHz Transmission Module
- 3741A-EW 65 to 110 GHz Transmission Module
- 3740A-V 50 to 75 GHz Transmission/Reflection Module
- 3740A-E 60 to 90 GHz Transmission/Reflection Module
- 3740A-EE 56 to 94 GHz Transmission/Reflection Module
- 3740A-W 75 to 110 GHz Transmission/Reflection Module
- 3740A-EW 65 to 110 GHz Transmission/Reflection Module

**13-3 PERFORMANCE SPECIFICATIONS**

Performance specifications are given below in Table 13-1.

**System Performance**

“Receiver Dynamic Range” is defined as the ratio of the maximum signal level at Port 2 for 0.1 dB compression to the noise floor at Port 2. “System Dynamic Range” is defined as the ratio of the power incident on Port 2 in a through line connection (reference) to the noise floor at Port 2 (forward measurements only). The “Noise Floor” is the maximum measured signal with the test ports terminated using 10 Hz IF bandwidth and 512 averages.

**Table 13-1.** Performance Specifications, Millimeter Wave Modules

Specification	Model				
	V Band (WR-15)	E Band (WR-12)	Extended E Band	W Band (WR-10)	Extended W Band
Frequency Range (GHz)	50–75	60– 90	56–60 60–85 85–94	75–100 100–110	65–75 75–100 100–110
Frequency Resolution	3 Hz	6 Hz	6 Hz	6 Hz	6 Hz
Max Signal Into Port 2	+8 dBm	+8 dBm	+8 dBm	+6 dBm	+6 dBm
Noise Floor	–90 dBm	–90 dBm	–85 dBm –90 dBm –76 dBm	–90 dBm –90 dBm	–90 dBm –89 dBm –87 dBm
Receiver Dynamic Range	98 dB	98 dB	93 dB 98 dB 84 dB	96 dB 96 dB	96 dB 95 dB 93 dB
High Level Noise (typical)	0.05 dB	0.06 dB	0.08 dB	0.06 dB	0.08 dB
Power Out (typical)	+7 dBm	+6 dBm	+5 dBm +6 dBm +4 dBm	+5 dBm +2 dBm	–5 dBm +5 dBm +2 dBm
System Dynamic Range	97 dB	96 dB	90 dB 96 dB 80 dB	95 dB 92 dB	85 dB 94 dB 89 dB

**Test Port Characteristics**

Test port characteristics for the waveguide connector used on the various modules are given in Table 13-2.

**Table 13-2.** Test Port Characteristics

Specification	Waveguide Designation									
	Offset Short Calibration					LRL Calibration				
	WR-15	WR-12	WR-12 Ext.	WR-10	WR-10 Ext.	WR-15	WR-12	WR-12 Ext.	WR-10	WR-10 Ext.
Frequency (GHz)	50–75	60–90	56–94	75–110	65–110	50–75	60–90	56–94	75–110	65–110
Directivity (dB)	>46	>46	>44	>46	>40	>46	>46	>44	>46	>40
Source Match (dB)	>37	>36	>33	>36	>30	>46	>46	>43	>46	>40
Load Match (dB)	>46	>46	>44	>46	>40	>46	>46	>44	>46	>40
Reflection Frequency Tracking (dB)	±0.030	±0.040	±0.080	±0.040	±0.080	±0.02	±0.02	±0.06	±0.02	±0.06
Transmission Frequency Tracking (dB)	±0.060	±0.060	±0.100	±0.070	±0.100	±0.02	±0.02	±0.06	±0.02	±0.06
Isolation (dB)	>90	>90	>80	>90	>80	>90	>90	>80	>90	>80

**Measurement Capabilities**

Measurement capabilities are the same as the standard 37XXXD. That is: Four Channels, Standard S-parameters as well as User Defined Parameters, Auto-Reversing, Data Points 1601, 801, 201, 51, N Discrete, and CW (see Appendix D).

**NOTE**

When a 37XXXD is configured as a Millimeter Wave System, the frequency range is extended per the specifications of the Millimeter Wave Modules and the system will be limited to operate with only two external sources. That is, the internal source is removed or disabled.

**13-4 INSTALLATION**

This section describes installation and system check-out. For instructions on installation of the wafer probe test station, refer to section 14-5.

**IMPORTANT NOTES**

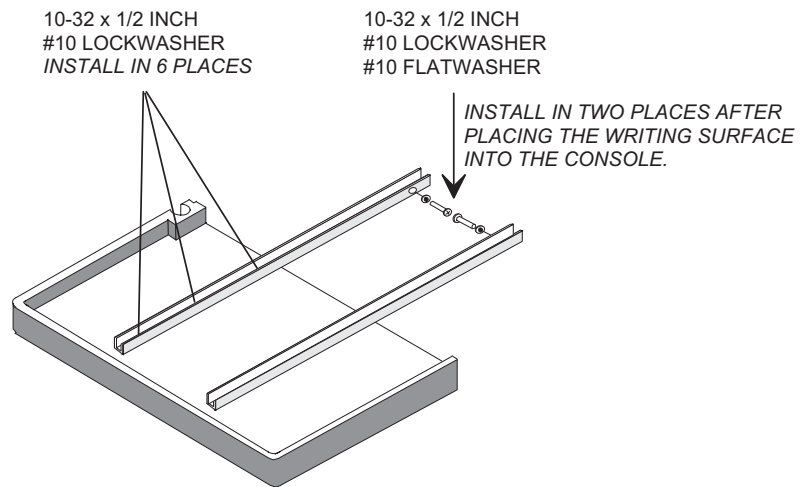
- The empty console weighs approximately 66kg (145 pounds). Use two people to remove the console from the pallet.
- Many of the instruments are quite heavy and require two people to lift them.
- Instruments should be loaded into the bottom sections of the console first, to prevent tipping of the console.
- The VNA instrument has fragile RF cables connected to both the front and rear panels. Be careful not to bend these cables when handling the instrument.
- If the synthesizers are not installed precisely as described below, the system will be non-functional.
- We suggest using an 8 in/lb torque wrench to tighten SMA connectors (available in most Anritsu VNA Calibration kits) Do not tighten any connectors over 8 in/lbs.



**Console and Table Setup**

Set up the console and table as described below.

- Step 1.** Remove the shipping container and all packaging and accessories from around the console. Set the table aside. Instructions for table installation appear later.
- Step 2.** Lift or roll the console off the pallet (to lift: insert two sections of lumber through the console top and lift it, using one person on each side).
- Step 3.** Cut the tie wraps which are securing the table mounting rails at the console rear door. Cut the tie wraps which are securing the power cords and wrist strap ground wire.
- Step 4.** Attach the mounting rails to the table as shown in Figure 13-1.

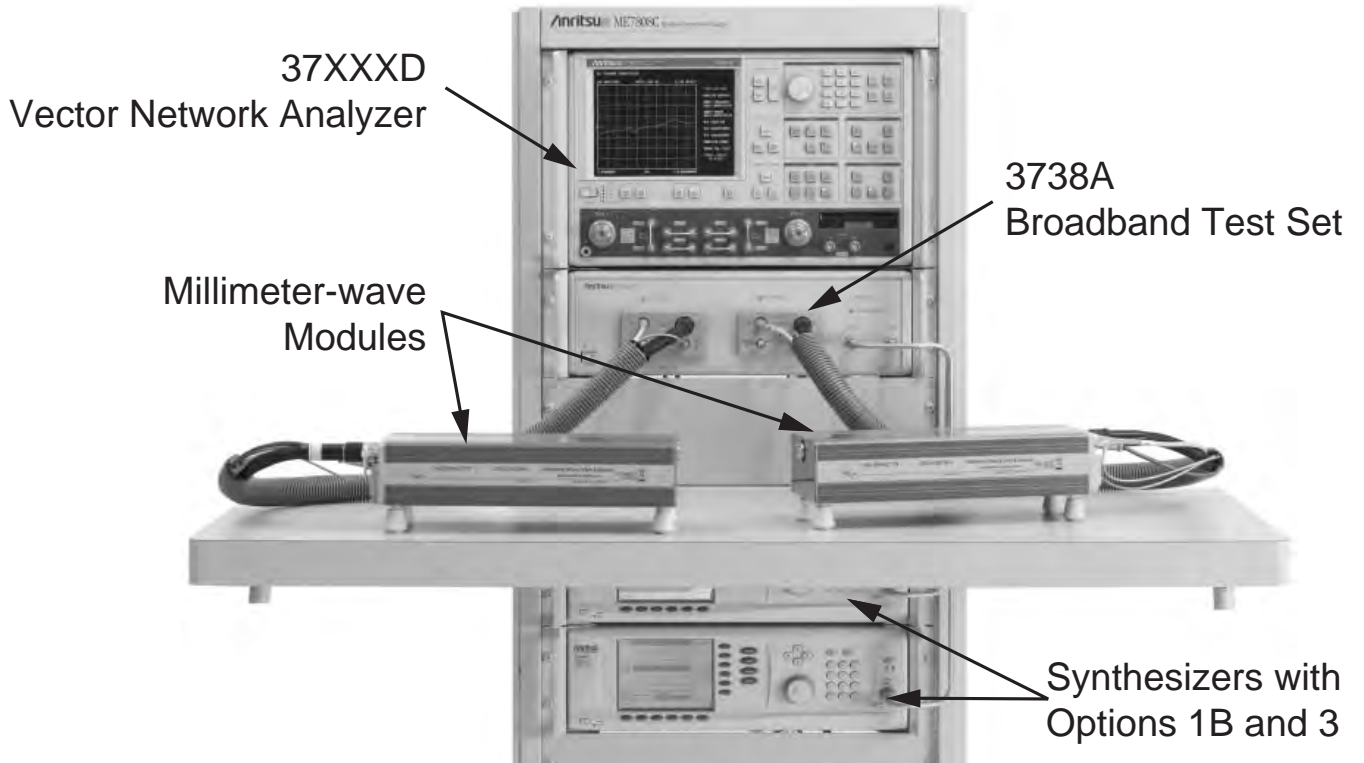


**Figure 13-1.** Console Table

***Instrument Installation  
into Console***

Refer to Figures 13-2, 13-, and 13-3 for installation of major instruments and cables.

- Step 1.*** Check the rear panel serial number labels of the synthesizers. The instrument without Option 15 belongs in the bottom compartment (“RF” synthesizer).
- Step 2.*** Install the synthesizer with Option 15 in the second opening from the bottom.
- Step 3.*** Install the VNA into the top compartment. Ensure the three small RF cables are installed onto the front and rear panels (one in front, and two in back).
- Step 4.*** Install the 3738A Test Set into the compartment below the VNA.
- Step 5.*** Secure all instruments in the console using the screws provided.
- Step 6.*** On the left front of the console, move the black ground wire away from the guide of the table-mounting rail, and install the table by sliding the table rails into the guides.
- Step 7.*** Secure the table rails at the rear of the console using the screws provided.



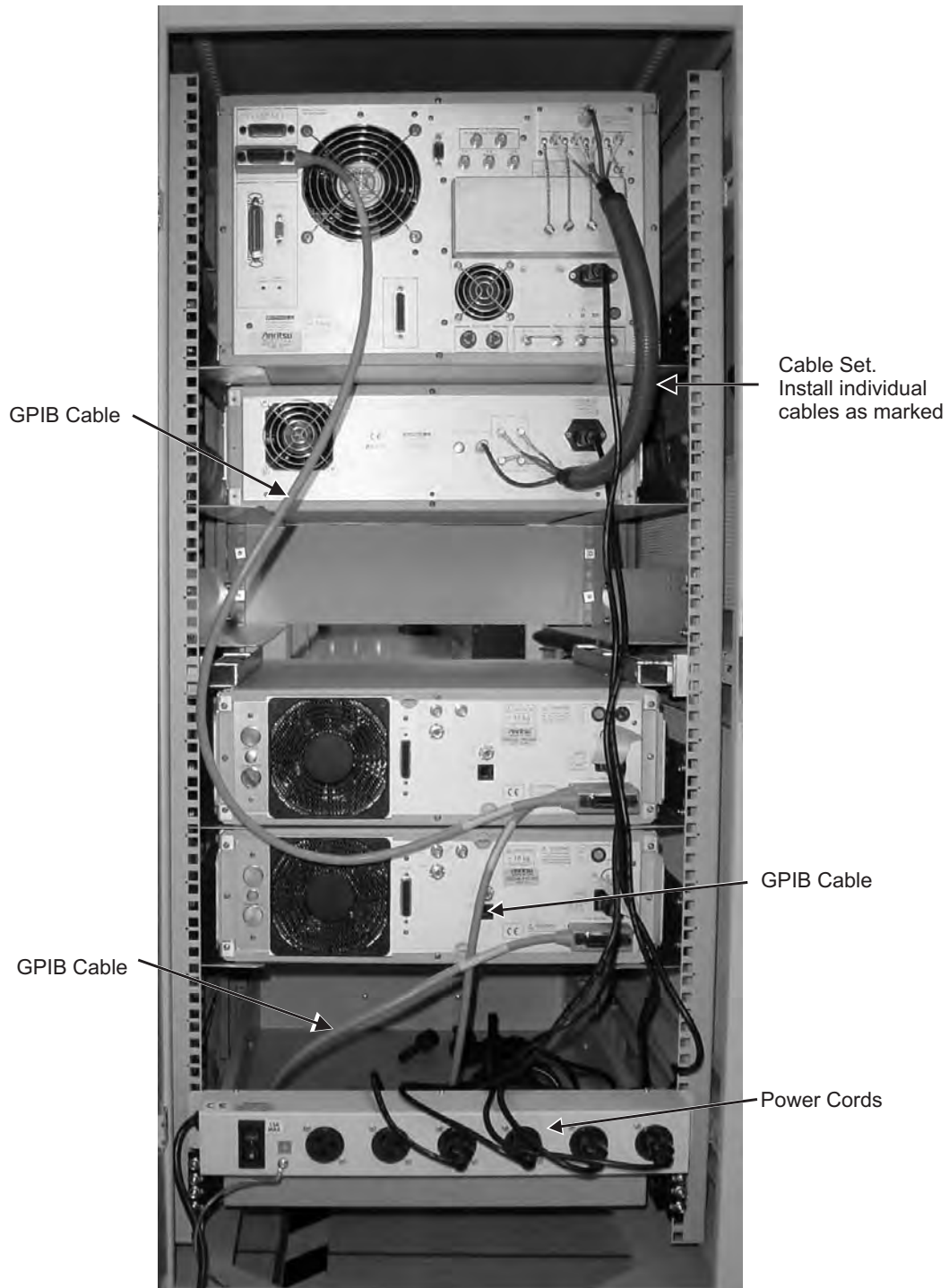
**Figure 13-2.** ME7808C Console Showing Major Components

- Step 8.** Lay the static-safe mat on the table and attach the ground cable.
- Step 9.** Unpack the millimeter-wave modules and set them on the table.

***System Cabling***

Connect ME7808C system cables as described below and shown in Figure 13-3 on the following page.

- Step 1.*** From the front, connect the rigid RF cable between the upper synthesizer and the 3738A LO IN connector. Ensure the connectors are seated correctly and tightened securely.
- Step 2.*** From the front, connect the rigid RF cable between the bottom synthesizer and the 3738A RF IN connector. Ensure the connectors are seated correctly and tightened securely.
- Step 3.*** From the front, install the two RF cable sets between the 3738A and the mmW modules. Connect exactly as the labels indicate.
- Step 4.*** From the rear, unscrew the four small chain-mounted terminations from on VNA (let them hang loose) and install the Cable Set. Connect individual cables as indicated on the labels .
- Step 5.*** Connect one GPIB cable from the lower (Dedicated) GPIB connector of the VNA to the upper synthesizer. Connect the second GPIB cable between the two synthesizers.
- Step 6.*** Insert the power cords into all 4 instruments and turn all the instruments on.
- Step 7.*** Ensure that the two synthesizers' GPIB addresses are set correctly. The top unit should be set to address 4 and the bottom unit should be set to address 5. This can be verified or changed by pressing SYSTEM | CONFIG | GPIB ADDRESS and entering the appropriate GPIB address.

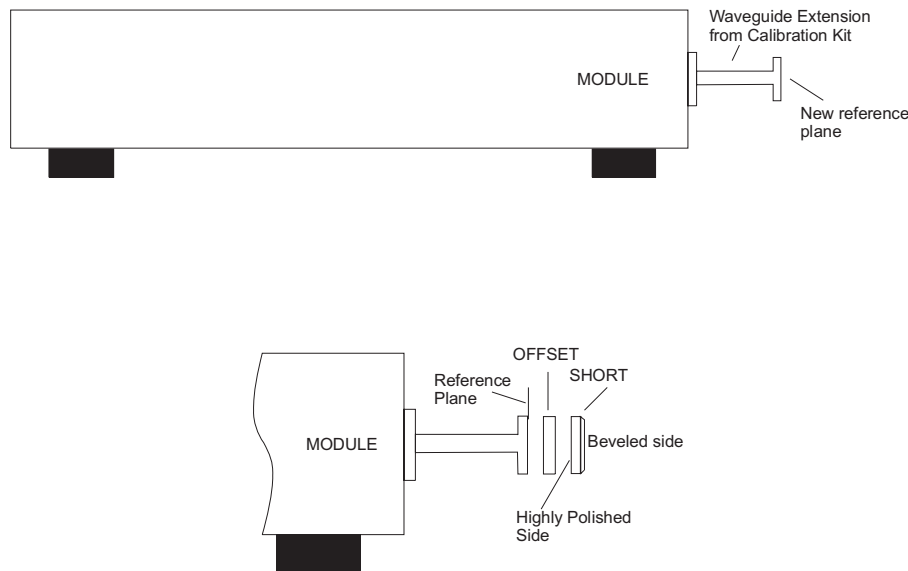


**Figure 13-3.** ME7808C Console Rear Panel Cabling

**13-5 CALIBRATION**

Calibration for millimeter wave measurements is accomplished using a waveguide offset-short method. Anritsu provides the Series 3655X, 3655X-1, 3755X, and 3755X-1 Calibration Kits, which contain all required precision calibration components. For optimum calibration and measurement results, the following apply to modules that are not provided with precision waveguide extensions. (Refer to Figure 13-4 below, for a supporting illustration.)

- ❑ Use the precision waveguide extension from the calibration kit to connect to the waveguide module
- ❑ During calibration connect the highly polished (non-beveled) side of the short toward the module



**Figure 13-4.** Waveguide Connections for Optimum Measurement and Calibration Results

**13-6 OPERATION**

The ME7808C Millimeter Wave System is menu driven and the millimeter wave operation is entered into via the Enhancement Key-Group's Options Menu key. Selecting **Millimeter Wave BAND DEFINITION** in that menu provides for defining measurement parameters; selecting **TEST SET CONFIG** provides for configuring the 3735B Test Set parameters (Figure 13-5, next page).

The menu options shown in Figure 13-5, Millimeter Wave System Menu Flow, are described in Appendix A, along with all of the other ME7808C menus. Additional operating instructions are provided below.

**Entering/ Leaving Millimeter Wave Operation**

Before entering the Millimeter Wave mode, users should have completed all of the steps in the "Installation" section of this manual. The system should be ready for operation, with all connections properly made to the Millimeter Wave test set, modules, and frequency synthesizers. The system should then be powered up, and the procedure below followed.

MENU OPTNS
OPTIONS
TRIGGERS
REAR PANEL OUTPUT
Millimeter Wave BAND DEFINITION
RECEIVER MODE
SOURCE CONFIG
TEST SET CONFIG

**NOTE**

Until the Millimeter Wave configuration is activated, the system will not operate and it will fail to lock.

**CAUTION**

The transition to or from Millimeter Wave operation is a major setup change that does NOT preserve the previous setup. All current set up and RF calibration information will be lost on entering or leaving the Millimeter Wave mode configuration. If the existing setup needs to be saved, this should be done before the system is reconfigured for Millimeter Wave mode operation.

When the millimeter wave band is selected, the system automatically reconfigures itself to measure at that frequency range. The lower and upper limits of the displayed sweep frequencies will change to the band selected. The frequency resolution changes to account for multiplier factors. However, users will (1) have access to the multiple source control definitions and (2) be able to change the sweep frequencies as desired.

**Procedure**

The first step is to press the Options button on the front panel. This brings up the menu OPTNS (top left). Select **TEST SET CONFIG**. This causes the menu OTS1 (bottom left) to appear.

MENU OTS1
TEST SET CONFIGURATION
INTERNAL
<b>MILLIMETER WAVE</b>

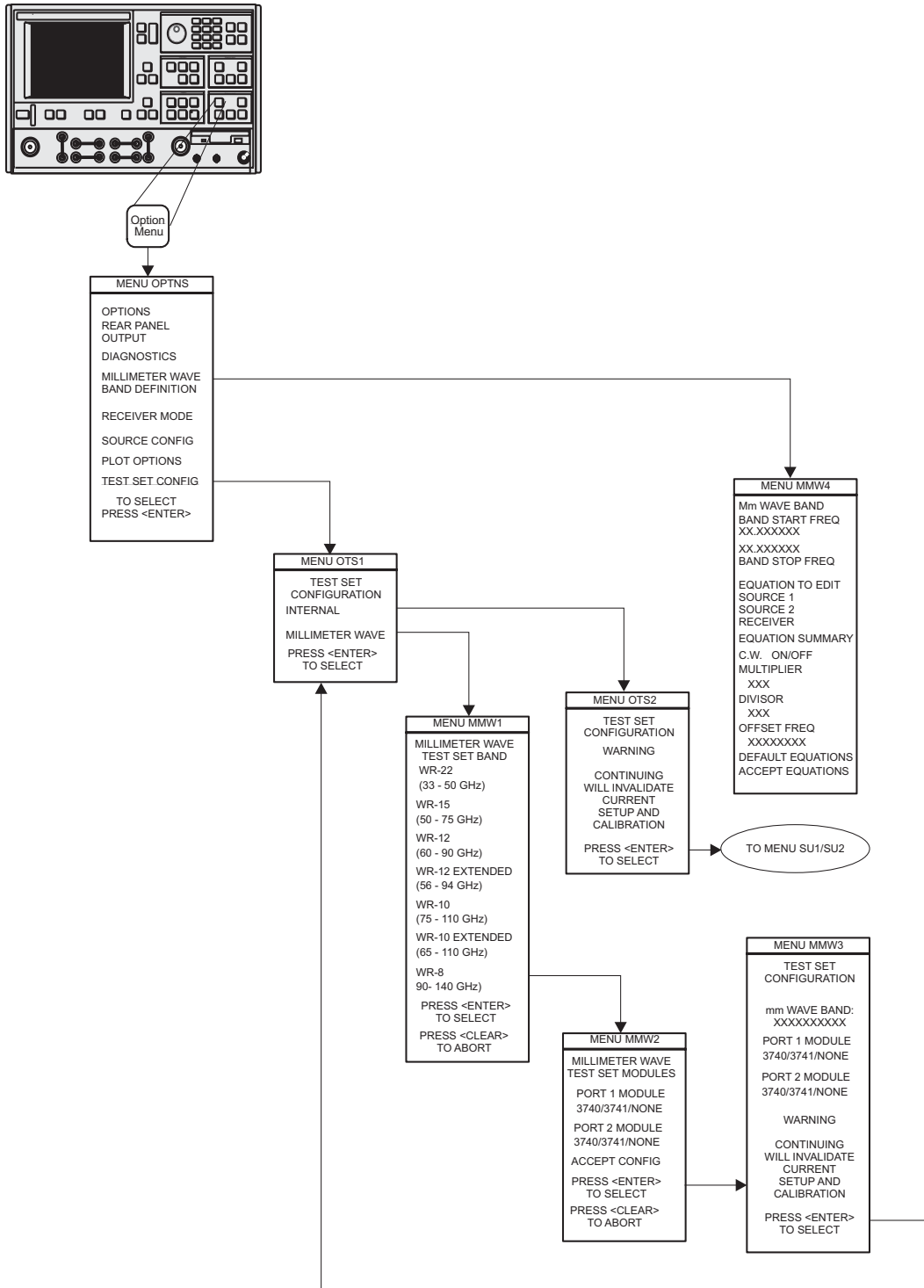


Figure 13-5. Millimeter Wave System Menu Flow



If the system is not already configured for Millimeter Wave operation, select **Millimeter Wave** to call menu MMW1 (top left).

---

MENU MMW1
MILLIMETER WAVE TEST SET BAND
WR-22 (33 - 50 GHz)
WR-15 (50 - 75 GHz)
WR-12 (60 - 90 GHz)
WR-12 EXTENDED (56 - 94 GHz)
WR-10 (75 - 110 GHz)
WR-10 EXTENDED (65 - 110 GHz)

In menu MMW1, select the millimeter wave band for which modules have been installed.

**CAUTION**

A band other than the one for which hardware is installed can be selected. In this case, the system may appear to operate normally, but it will not make accurate measurements.

Upon completing the selection in the menu MMW1, menu MMW2 (bottom left), appears.

---

---

MENU MMW2
MILLIMETER WAVE TEST SET MODULES
PORT 1 MODULE 3740/41/42/NONE
PORT 2 MODULE 3740/41/42/NONE
ACCEPT CONFIG
PRESS <ENTER> TO SELECT
PRESS <CLEAR> TO ABORT

---

---

MENU MMW3
TEST SET CONFIGURATION
mmWAVE BAND XXXXXXXX
PORT 1 MODULE 3740
PORT 2 MODULE 3740
WARNING
CONTINUING MAY INVALIDATE CURRENT SETUP AND CALIBRATION
PRESS <ENTER> TO SELECT
PRESS <CLEAR> TO ABORT

---

In this menu, select which module is Transmission-Reflection and which is Transmission Only. Do this carefully, as an incorrect selection causes the wrong S-parameters to be displayed. Once the selection is made in this menu, MMW3 (left) appears.

At this point, users have one last opportunity to abort the change in configuration, by pressing the Clear key. If the Enter key is pressed, the old configuration is lost. The system is reconfigured for millimeter wave operation.

***Changing Bands/Modules While in Millimeter Wave***

The effect of changing millimeter wave bands while in Millimeter Wave mode operation will be to (1) change the sweep frequency range to the default range for the new band and (2) delete any current RF calibrations. Therefore, the Caution on page 13-13 applies, and it is unlikely that any calibration would be valid if the modules are changed. (This is because of manufacturing variations from module to module.)

To configure the system for a different band or for one or more different modules, follow the exact same steps as described on pages 13-14 through 13-16, except that only the new band or module types are changed.

***Allowable Millimeter Wave Module Configurations, Measurements and Calibrations***

The S-parameter measurements and RF calibrations allowed are a function of the type of millimeter wave module users have selected in menu MMW2. Note that one could actually have only one module and still make reflection-only measurements. The criteria in Table 13-4 applies.

**Table 13-4.** Calibration Criteria

MMW Modules		Allowed S-parameters				Allowed RF Calibrations						
Port 1	Port 2	S11	S12	S21	S22	12 Term	Forward 1 Path 2 Port	Reverse 1 Path 2 Port	Reflection P1	Reflection P2	Forward Trans	Reverse Trans
3740	3740	X	X	X	X	X	X	X	X	X	X	X
3740	3741	X		X			X		X		X	
3741	3740		X		X			X		X		X
3741	3740	b1/1	b2/1	b2/1	b1/1			X		X		X

***Effect of Default Program***

Because the system is reconfigured for Millimeter Wave mode operation, the effects of performing a “Default Program” are somewhat different. Performing a default program operation, either from the front panel or via the GPIB will have the following results:

- ❑ Pressing the Default Program key twice:  
The Millimeter Wave operating band, its associated frequency range, multipliers, and millimeter wave module types will remain unchanged. If the frequency range has been modified from the default values for the band, the modified values will remain in force. The current sweep range will be set to the band frequency range. This is consistent with other similar setup parameters, such as GPIB addresses
- ❑ Pressing the Default Program key, then the 1 data entry key:  
Except for clearing the internal setup memories, the effect will be the same as for pressing the Default Program key twice
- ❑ Pressing the Default Program key, then the 0 data entry key:  
The system resets to its default, non-millimeter wave configuration; that is, internal source active, no multiple source equations, normal default system frequency range, and internal test set configuration. If the “delete source” option is active, the system will attempt to use an external source for source 1

The restrictions stated in the above “Allowable Microwave Modules Configurations, Measurements, and Calibrations” section (previous page) will impact the display resulting from a “Default - Default” action. S-parameters displayed will be as indicated above, while the channel configuration will be as shown in Table 13-5.

**Table 13-5.** *Channel Configuration*

MMW Modules		Default Channel Configuration	S-parameters Assigned			
Port 1	Port 2		Ch 1	Ch 2	Ch 3	Ch 4
3740	3740	All Four Channels	S11	S12	S21	S22
3740	3741	Dual, Channels 1 and 3	S11	S21	S21	S11
3741	3740	Dual, Channels 2 and 4	S22	S12	S12	S22
3741	3741	All Four Channels	b1/1	b2/1	b2/1	b1/1

**Note:** In the case of two 3741’s, the system will be put into SET ON mode. If users provide a phase-lock signal, they may set the “user-defined” receiver mode to TRACKING.

***Redefinition of Band Frequency Ranges***

MENU OPTNS
OPTIONS
TRIGGERS
REAR PANEL OUTPUT
<b>Millimeter Wave BAND DEFINITION</b>
RECEIVER MODE
SOURCE CONFIG
TEST SET CONFIG

It is possible to modify the Millimeter Wave band equations to a range different than the default range for the band currently installed. This is done by pressing the Options key to display menu OPTNS (top left). In this menu, select **Millimeter Wave BAND DEFINITION** and cause menu MMW4 (bottom left) to appear.

The receiver equation or either of the sources may be edited. New values for the multiplier, the divisor, or the offset may be entered. To apply the selections, select **ACCEPT EQUATIONS**. Or select **DEFAULT EQUATIONS** to return selections or edits to the standard default values.

The EXT\_MILLIMETER WAVE 4 menu (Figure 13-6, following page) appears next to menu Millimeter Wave 4 to provide the current or proposed band information.

**CAUTION**

It is possible for the equations to be set to values that may prevent normal operation of the system, due to excessive frequency range beyond the capabilities of the system hardware. The only way of restoring the system to its known default settings is by selecting **DEFAULT EQUATIONS** then **ACCEPT EQUATIONS** in menu MMW 4. Using the **DEFAULT-DEFAULT** method *will not* reset the equations.

MENU MMW4
mmWAVE BAND
BAND START FREQ 65.000000
BAND STOP FREQ 110.000000

If the frequency range of a millimeter wave band is changed to a range where some or all of the frequencies are outside of the default range for that band, or if the frequency multipliers are altered, the change will be allowed, but upon selecting **ACCEPT EQUATIONS** in menu MMW4, a warning message will be issued in the data area: "CAUTION: NON-STD BAND DEFINITION." If the frequency range of a Millimeter Wave band is changed to a range that is a subset of the default range for that band, no warning message will be issued.

- MILLIMETER WAVE BAND DEFINITION SUMMARY -

	BAND FREQUENCY RANGE
BAND STOP F	BAND START F
XXX.XXXXXX XXX	XXX,XXXXXX XXX

FREQUENCY = (MULTIPLIER/DIVISOR) \* F + OFFSET FREQ)  
 SOURCE 1 = (1/ 8) \* (F- 0.270000 GHz)  
 SOURCE 2 = (1/ 6) \* (F + 0.000000 GHz)  
 RECEIVER = (1/ 1) \* (0.270000 GHz C.W.)

- NOTES -

1. SELECT <DEFAULT EQUATIONS> TO OVERWRITE DEFINITION WITH VALUES SUITABLE FOR THE MILLIMETER WAVE BAND.
2. SELECT <ACCEPT EQUATIONS> TO CONFIRM ANY CHANGES.
3. PERFORMANCE SPECIFICATIONS ARE VALID ONLY WHILE USING THE DEFAULT EQUATIONS OVER THE DEFAULT BAND FREQUENCY RANGE.
4. DEVIATING FROM THE DEFAULT MAY CAUSE LOCK FAILURES.

**Figure 13-6.** Menu EXT\_MMW4

***Use of Normal Multiple Source Mode***

While the millimeter wave feature is active, the normal multiple source mode *will not* be available. Access to the menus OM0 through OM2 *will not* be allowed. If the system is in multiple source mode when switched to millimeter wave, all multiple source information will be lost, and the unit will return to normal (single source) operation when millimeter wave operation is ended. In Millimeter Wave mode, users may change the default values of the current waveguide band frequency range, multipliers, and offset (CW-IF) frequency, by using menu MMW4.

***Stored Setups and Calibrations***

The Millimeter Wave band definition and module information is stored with a stored setup in internal memory, and with the setup and RF CAL on disk. When a setup is recalled, first the band and module types will be compared with the current settings. If different, the setup will be rejected, and a message "ABORTED: HARDWARE DIFFERENT" will be posted. If the hardware settings are compatible, the frequency range of the stored setup will be compared with the current system low and high frequency limits, in case the user has employed a customized-band definition. If the recalled setup is within the current frequency range of the system, it will be recalled with no warning—even if the current range is customized. If the recalled setup is outside the normal frequency range, or if it has changed equations (been customized) it will be recalled. However, a time-out warning message will be issued in the data area: "CAUTION: NON-STD BAND DEFINITION."

***External Source and Power Levels***

When **MILLIMETER WAVE** has been selected in menu OTS1, the system checks for the existence of two external sources. If either source is not connected and operating, a warning message is posted to the screen. On entering Millimeter Wave mode operation, the system will automatically be configured to use the two external sources. The Millimeter Wave mode will not function properly with low source-power levels. Therefore, on entering this mode the source-power levels will be adjusted to a predefined level. However the Source Config and Test Signals menus will still be available to users, to change power settings and source configuration if so desired.

**13-7 MEASUREMENT PROCEDURE**

MENU MMW1
MILLIMETER WAVE TEST SET BAND
WR-22 (33 - 50 GHz)
WR-15 (50 - 75 GHz)
WR-12 (60 - 90 GHz)
WR-12 EXTENDED (56 - 94 GHz)
WR-10 (75 - 110 GHz)
WR-10 EXTENDED (65 - 110 GHz)
WR-8 (90 - 140 GHz)
PRESS <ENTER> TO SELECT

MENU MMW2
MILLIMETER WAVE TEST SET MODULES
PORT 1 MODULE 3740/3741/NONE
PORT 2 MODULE 3740/3741/NONE
ACCEPT CONFIG
PRESS <ENTER> TO SELECT

The measurement of a Device Under Test (DUT) using the Millimeter Wave mode is quite similar to one using a coaxial measurement technique. However, due to the more complex nature of the Millimeter Wave System equipment, additional care must be taken to ensure that everything is set up properly. Depending upon the type of measurement being performed, the setup may vary. The following is a description of a typical measurement procedure for a passive two-port DUT.

**Step 1.**

*Verify Correct Band Definition*

Use menu MMW1 (top left) to examine the current millimeter wave band selection, and menu MMW2 (bottom left) to examine the current module selections to be sure that they match the installed hardware. Examine menuMMW4 (next page) to verify that the band equations are set correctly. If there is any doubt whether the setting are correct, use the **DEFAULT EQUATIONS** selection to reset them.

**Step 2.**

*Verify Correct Setup for the System*

The safest way to do this is to press the Default key twice. This returns the system to the proper frequency range and power settings for the current millimeter wave hardware configuration. It is very important that the RF sources be set to the correct power levels. Set Source 1 (LO) to +17 dBm and Source 2 (RF) to +13 dBm.

**Step 3.**

*Perform and Verify an RF Calibration*

The system may now be calibrated using an appropriate Anritsu Calibration Kit. Be sure to load the calibration kit information from the provided floppy disk into the instrument first. The default calibration type is Offset-Short, but an LRL/LRM calibration may also be used. See Chapters 4 and 7 for help with RF Calibration details. Consult Table 13-4 for limitations on which calibrations may be performed as a function of the module types installed.

**Step 4.**

*Attach the DUT*

Use the calibrated torque wrench provided with the Calibration Kit to tighten the waveguide flange retaining screws on the DUT. This results in more reproducible measurements.

**Step 5.**

*Select the S-parameter(s) and Graph Type(s) to Be Used for the Measurement*

The selection may be limited due to the types of millimeter wave modules installed. Consult Table 13-4 on page 13-17 for further information.



MENU MMW4	
mmWAVE BAND	
BAND START FREQ	65.000000
BAND STOP FREQ	110.000000
EQUATION TO EDIT	
SOURCE 1	
SOURCE 2	
RECEIVER	
EQUATION SUMMARY	
CW	OFF
MULTIPLIER	1
DIVISOR	8
DEFAULT EQUATIONS	

**Step 6.**

*Set the Display Scale*

This may be done most quickly by selecting each active channel, and pressing the Autoscale key. The scale and reference values may then be set to a desired value using the appropriate SET SCALE menu for the graph type selected.

**Step 7.**

*Observe the Measured Data*

It should not vary from sweep to sweep, and should be within the range expected for the type of measurement. Re-check tightness of the flange retaining screws if data appears abnormal.

**Step 8.**

*Save the Calibration and Setup On the Hard Disk*

Press the Save/Recall key to initiate the saving of the current setup. An instrument setup in the millimeter wave configuration may be saved exactly like any other VNA setup and RF calibration.

**NOTE**

Anritsu strongly recommends that any setup and calibration used for measurement be saved.

**13-8 REMOTE OPERATION**

All functions of the ME7808C can be controlled remotely, via the IEEE 488 Bus (GPIB). The remote operation and controlling commands are provided in the 37XXX Programming Manual (PN: 10410-00262).

**13-9 OPERATIONAL CHECKOUT—GENERAL**

The Operational Checkout subsection provides for checking that the ME7808C Millimeter Wave System is functioning properly.

**Required Equipment**

The following equipment is required to perform the verification tests.

MENU OPTNS
OPTIONS
TRIGGERS
REAR PANEL OUTPUT
Millimeter Wave BAND DEFINITION
RECEIVER MODE
SOURCE CONFIG
<b>TEST SET CONFIG</b>

Model	Description	Quantity
Anritsu 3655 Series	Waveguide Calibration Kit, with Option 1: Sliding Termination	1

**Step 1.** Remove the silver straight waveguide sections from the modules, if installed.

**Step 2.** Install the precision-straight waveguide sections that are contained in the calibration kit on the waveguide output connector of each millimeter module.

**NOTE**

These waveguide sections (test port adapters) use high precision flanges to improve connection repeatability and calibration quality. They must be used to ensure specified system performance.

**Step 3.** Apply power to both system Sources and allow them to complete self test.

**Step 4.** Apply power to the network analyzer.

**Step 5.** Press the Option Menu key, select **TEST SET CONFIG** to configure the system for the types of millimeter modules used.

**Step 6.** Allow the system to warm up for at least 60 minutes to ensure operation to performance specifications.

**13-10 OPERATION  
CHECKOUT—IF  
POWER LEVEL TEST**

This test verifies that each individual receiver channel operates properly. Measurement calibration of the system is not required for this test.

**Test Setup**

Set up test equipment as described below:

Key	Menu Choice
SETUP MENU	START: Low-end Frequency STOP: High-end Frequency
CHANNEL MENU	DUAL CHANNELS 1 & 3
GRAPH TYPE	LOG MAGNITUDE (both channels)
S-PARAMS	Channel 1 User Ratio: a1/1 User Phase Lock: a1 Channel 3 User Ratio: b1/1 User Phase Lock: a1
SET SCALE	RESOLUTION: 10.0 dB/DIV REF VALUE: -10.0 dB (both channels)

**Step 1.**

Install a flush short on the output of the 3740A-X module connected to Port 1.

**Step 2.**

Set up the network analyzer controls as shown at left.

**NOTE**

For 3741A Series, use limit settings for b1/1 (b2/1).

**Test Procedure**

The test procedure is described below:

Key	Menu Choice
CHANNEL MENU	DUAL CHANNELS 2 & 4
S-PARAMS	Channel 2 User Ratio: a2/1 User Phase Lock: a2 Channel 4 User Ratio: b2/1 User Phase Lock: a2

**Step 1.**

Observe sweep indicator and allow at least one complete sweep to occur.

**Step 2.**

Verify that the measurement traces fall within the limit lines (Table 13-6, following page).

**Step 3.**

If the second module connected to Port 2 is also a Model 3740A-X Transmission/Reflection module, change the setup to that shown at the top left and perform Step 4. Otherwise, skip to Step 7.

**Step 4.**

Install a flush short to the output of the 3740A-X module on Port 2.

**Step 5.**

Verify that the measurement traces fall within the limit lines.

**Step 6.**

If the second module to be tested is a Model 3741A-X, connect the two modules together and change the setup to that shown at the bottom left.

Key	Menu Choice
CHANNEL MENU	SINGLE CHANNEL
S-PARAMS	Channel 3 User Ratio: b2/1 User Phase Lock: a1

**Step 7.**

Verify that the measurement trace falls within the limit lines.

**Table 13-6.** *Limit Line Settings*

Limit Type	Model and Frequency Range (GHz)										
	3740A-Q 33-50	3740A-V 50-75	3740A-E 60-90	56-60	3740A-EE 60-85	85-94	3740A-W and 3740A-EW 65-75 75-100 100-110			3740A-F 90-140	
a1/1 (a2/1) UPPER LIMIT dB	-5	-5	-5	-5	-5	-5	-5	-5	-5	-5	-5
a1/1 (a2/1) LOWER LIMIT dB	-29	-27	-29	-34	-29	-39	-39	-24	-34	-39	-39
b1/1 (b2/1) UPPER LIMIT dB	-2	-2	-2	-2	-2	-2	-2	-2	-2	-2	-2

**13-11 OPERATIONAL CHECKOUT— TRANSMISSION HIGH LEVEL NOISE TEST**

The following test verifies that the transmission high-level noise in the ME7808C Millimeter VNA System will not significantly affect the accuracy of subsequent measurements. High-level noise is the random noise that exists in the ME7808C Millimeter VNA System. Because it is non-systematic, it cannot be accurately predicted or measured. Thus, it cannot be removed using conventional error-correction techniques. Measurement calibration is not required for this test.

Key	Menu Choice
SETUP MENU	START: Low-end Frequency STOP: High-end Frequency
CHANNEL MENU	DUAL CHANNELS 1 & 3 (two 3740A-X's) SINGLE CHANNEL 3 (one 3740A-X and one 3741A-X)
GRAPH TYPE	LOG MAGNITUDE (both channels)
SET SCALE	RESOLUTION: 0.050 dB/DIV REF VALUE: 0.0 dB (both channels)
S-PARAMS	Channel 1 S12 Channel 3 S21
DATA POINT	401
VIDEO IF BW	1 KHz

**NOTE**

This test is not applicable if you are only using a single 3740A-X module on Port 1.

**Test Setup**

Set up the ME7808C Millimeter VNA System controls as shown at left.

**Test Procedure**

The test procedure is described below.

- Step 1.** Connect the two modules together.
- Step 2.** If using two 3740A-X's, press the Ch 1 key and perform Steps 3 through 9. Otherwise, go to Step 10.
- Step 3.** Press the Trace Memory key.

---

MENU NO1
TRACE MEMORY FUNCTIONS
<b>VIEW DATA</b>
VIEW MEMORY
VIEW DATA AND MEMORY
<b>VIEW DATA (/) MEMORY</b>
SELECT TRACE MATH
<b>STORE DATA TO MEMORY</b>
DISK OPERATIONS

---

- Step 4.** Choose **VIEW DATA** from the menu (left) and press the Enter key.
- Step 5.** While observing the sweep indicator, allow at least two complete sweeps to occur. (One complete sweep if using single channel display.)
- Step 6.** Choose **STORE DATA TO MEMORY** from menu and press the Enter key.
- Step 7.** Choose **VIEW DATA / MEMORY** from the menu and press the Enter key.
- Step 8.** While observing the sweep indicator, allow at least two complete sweeps to occur. (One complete sweep if using single channel display.)
- Step 9.** Verify that the peak-to-peak High Level Noise falls within the area between the two limit lines.
- NOTE**  
Displayed data is only valid for the first few sweeps.
- Step 10.** Press the Ch 3 key.
- Step 11.** Repeat Steps 4 through 9 for channel 3.

**13-12 OPERATIONAL CHECKOUT— REFLECTION HIGH LEVEL NOISE TEST**

The following test verifies that the reflection high-level noise in the ME7808C Millimeter VNA System will not significantly affect the accuracy of subsequent measurements. High-level noise is the random noise that exists in the ME7808C Millimeter VNA System. Because it is non-systematic, it cannot be accurately predicted or measured. Thus, it cannot be removed using conventional error-correction techniques. Measurement calibration is not required for this test.

Key	Menu Choice
SETUP MENU	START: Low-end Frequency STOP: High-end Frequency
CHANNEL MENU	DUAL CHANNELS 1 & 3 (two 3740A-X's) SINGLE CHANNEL 3 (one 3740A-X and one 3741A-X)
GRAPH TYPE	LOG MAGNITUDE (both channels)
SET SCALE	RESOLUTION: 0.050 dB/DIV REF VALUE: 0.0 dB (both channels)
S-PARAMS	Channel 1 S11 Channel 3 S22
DATA POINT	401
VIDEO IF BW	1 KHz

**Test Setup**

Set up the ME7808C Millimeter VNA System controls as shown at left.

**Test Procedure**

The test procedure is described below:

- Step 1.** Attach the flush short to the waveguide port on the 3740A-X on Port 1 (and Port 2, if two are used); leave the waveguide port on 3741A-X unterminated.
- Step 2.** Press the Ch 1 key.
- Step 3.** Press the Trace Memory key.

---

<b>MENU NO1</b>
TRACE MEMORY FUNCTIONS
<b>VIEW DATA</b>
VIEW MEMORY
VIEW DATA AND MEMORY
<b>VIEW DATA (/) MEMORY</b>
SELECT TRACE MATH
<b>STORE DATA TO MEMORY</b>

---

**Step 4.**

Choose **VIEW DATA** from the menu (left) and press the Enter key.

**Step 5.**

While observing the sweep indicator, allow at least two complete sweeps to occur. (One complete sweep if using single channel display.)

**Step 6.**

Choose **STORE DATA TO MEMORY** from the menu and press the Enter key.

**Step 7.**

Choose **VIEW DATA (/) MEMORY** from the menu and press the Enter key.

**Step 8.**

While observing sweep indicator, allow at least two complete sweeps to occur. (One complete sweep if using single channel display.)

**Step 9.**

Verify that the peak-to-peak High Level Noise falls within the area between the two limit lines.

**NOTE**

Displayed data is only valid for the first few sweeps.

**Step 10.**

If two 3740A-X's are used, press the Ch 3 key and repeat Steps 4 through 9 for channel 3.



# **Chapter 14**

## **ME7808C Broadband Measurement System**

### **Table of Contents**

---

14-1	INTRODUCTION . . . . .	14-3
14-2	SYSTEM DESCRIPTION . . . . .	14-3
	Measurement Instruments . . . . .	14-3
	Console and Associated Hardware . . . . .	14-4
	Cables . . . . .	14-4
14-3	INSTALLATION . . . . .	14-4
	Console and Table Setup . . . . .	14-4
	Instrument Installation into Console . . . . .	14-6
	System Cabling . . . . .	14-8
14-4	INITIAL ELECTRICAL TESTS . . . . .	14-10
	Millimeter Module Checkout. . . . .	14-10
	40 MHz to 65 GHz Checkout. . . . .	14-11
14-5	WAFER PROBE STATION . . . . .	14-12
14-6	BROADBAND MENUS, FLOW. . . . .	14-14
14-7	BROADBAND CALIBRATION. . . . .	14-15
	Merging Calibrations. . . . .	14-15



# **Chapter 14**

## **ME7808C Broadband Measurement System**

### **14-1 INTRODUCTION**

This chapter describes the ME7808C Broadband Measurement System and the broadband mode of operation (40 MHz to 110 GHz). For other setup modes, refer to Chapter 13 (Millimeter Wave System), or other pertinent chapters in this manual. Model 3742A-EW modules (65 to 110 GHz) are assumed to be installed on the system, even though other modules are available.

The W1 Calibration Kit (P/N 3656) is designed for the purpose of performing coaxial calibrations with the ME7808C Vector Network Analyzer up to 110 GHz. The calibration kit comprises of Open, Short, and Load standards to enable two sets of calibrations—a Short Open Load Thru (SOLT) calibration from 40 MHz to 65 GHz, and a Triple Offset Short (SSST) calibration from 65 to 110 GHz (refer to Chapter 7, Measurement Calibration for these calibration procedures). The ME7808C firmware supports concatenation to allow merging of the two calibrations for broadband corrected measurements from 40 MHz to 110 GHz (discussed later in this chapter). In addition, the calibration kit includes fixed and interchangeable adapters, which may be used as test port connector savers. The interchangeable adapters have one fixed end and one interchangeable end that can be changed to a male or female for non-insertable device measurements.

**14-2 SYSTEM DESCRIPTION**

The ME7808C Broadband system is normally composed of the following Anritsu instruments and accessories (your system may vary depending on your application):

**Measurement Instruments**

- 37X97D Vector Network Analyzer with Options 1A, 2A, and 15V
- Two MG3692B Synthesized Signal Generators with Options 1B and 3
- 3738A Millimeter Test Set
- 3742A-EW Millimeter Module (quantity 2)
- 66670-2 (left) and 66671-2 (right) Coupler (quantity 1)

**Console and Associated Hardware**

- Console
- Table
- Mounting rails for Table (quantity 2)
- Static Dissipative Mat for Table
- Wrist Strap

**Cables**

- Rigid RF Cable (Upper synthesizer to 3738A)
- Rigid RF Cable (Lower synthesizer to 3738A)
- Cable Assembly (3742A to 3738A front panel) (quantity 2)
- Cable Assembly (3738A rear panel to VNA rear panel) (quantity 1)
- Flexible RF Cable (coupler to VNA) (quantity 4)
- GPIB Cable (VNA to Synthesizer) (quantity 2)
- Power Cord (quantity 4)

## **14-3** *INSTALLATION*

This section describes installation and system check-out without making use of a wafer-probe test station. For instructions on installation of the wafer probe test station, refer to section 14-5.



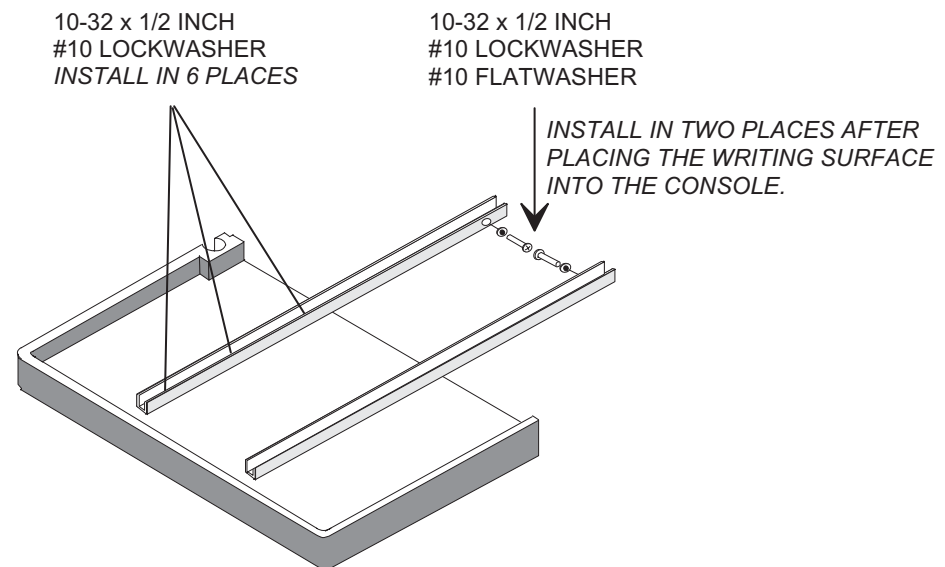
### ***IMPORTANT NOTES***

- The empty console weighs approximately 66kg (145 pounds). Use two people to remove the console from the pallet.
- Many of the instruments are quite heavy and require two people to lift them.
- Instruments should be loaded into the bottom sections of the console first, to prevent tipping of the console.
- The VNA instrument has fragile RF cables connected to both the front and rear panels. Be careful not to bend these cables when handling the instrument.
- If the synthesizers are not installed precisely as described below, the system will be non-functional.
- We suggest using an 8 in/lb torque wrench to tighten SMA connectors (available in most Anritsu VNA Calibration kits) Do not tighten any connectors over 8 in/lbs.

**Console and Table Setup**

Set up the console and table as described below.

- Step 1.** Remove the shipping container and all packaging and accessories from around the console. Set the table aside. Instructions for table installation appear later.
- Step 2.** Lift or roll the console off the pallet (to lift: insert two sections of lumber through the console top and lift it, using one person on each side).
- Step 3.** Cut the tie wraps which are securing the table mounting rails at the console rear door. Cut the tie wraps which are securing the power cords and wrist strap ground wire.
- Step 4.** Attach the mounting rails to the table as shown in Figure 14-1.



**Figure 14-1.** Console Table

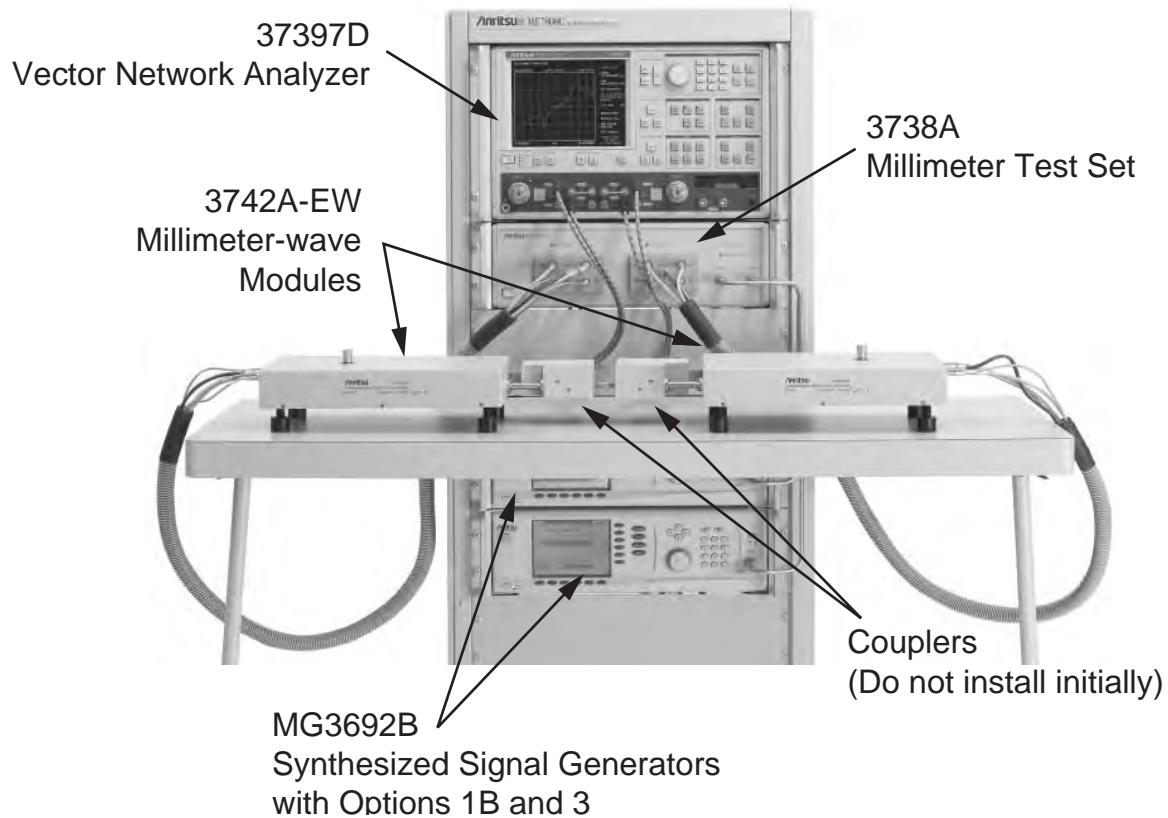
***Instrument Installation  
into Console***

Refer to Figures 14-2 and 14-3 for installation of major instruments and cables.

- Step 1.*** Check the rear panel serial number labels of the synthesizers. The instrument without Option 15 belongs in the bottom compartment (“RF” synthesizer).
- Step 2.*** Install the synthesizer with Option 15 in the second opening from the bottom.
- Step 3.*** Install the VNA into the top compartment. Ensure the three small RF cables are installed onto the front and rear panels (one in front, and two in back).
- Step 4.*** Install the 3738A Test Set into the compartment below the VNA.
- Step 5.*** Secure all instruments in the console using the screws provided.
- Step 6.*** On the left front of the console, move the black ground wire away from the guide of the table-mounting rail, and install the table by sliding the table rails into the guides.
- Step 7.*** Secure the table rails at the rear of the console using the screws provided.

**Step 8.** Lay the static-safe mat on the table and attach the ground cable.

**Step 9.** Unpack the 3742A-EW modules and set them on the table. Do not attach the couplers to the module test ports - they will not be tested at this time. (To test the couplers requires a W1 (1 mm) Male-Male adapter for mating of Port 1 to Port 2, or a full installation on a wafer probe station.)



---

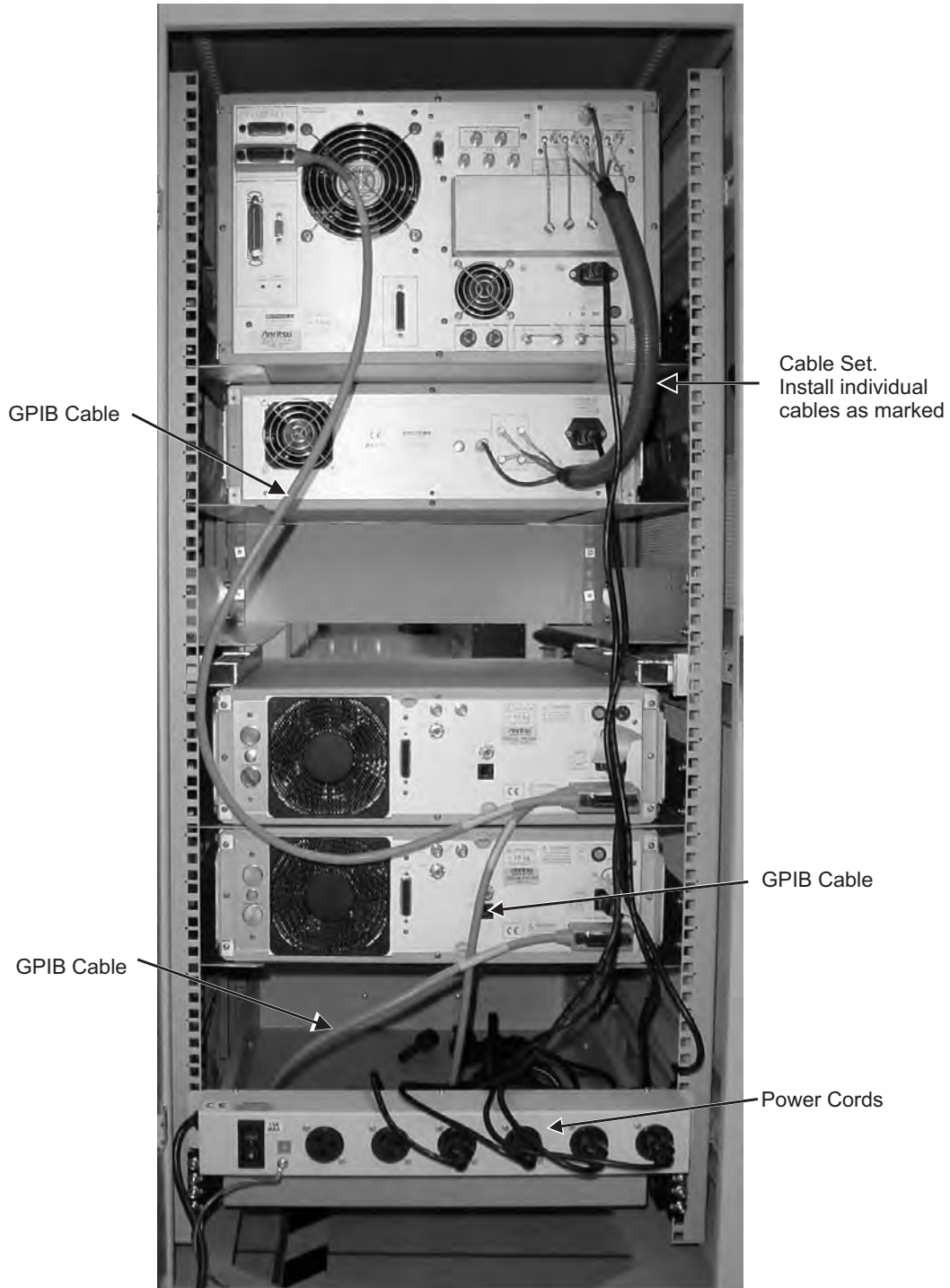
**Figure 14-2.** ME7808C Console Showing Major Components



***System Cabling***

Connect ME7808C system cables as described below and shown in Figure 14-3 on the following page.

- Step 1.*** From the front, connect the rigid RF cable between the upper synthesizer and the 3738A LO IN connector. Ensure the connectors are seated correctly and tightened securely.
- Step 2.*** From the front, connect the rigid RF cable between the bottom synthesizer and the 3738A RF IN connector. Ensure the connectors are seated correctly and tightened securely.
- Step 3.*** From the front, install the two RF cable sets between the 3738A and the 3742A-EW modules. Connect exactly as the labels indicate.
- Step 4.*** From the rear, unscrew the four small chain-mounted terminations from on VNA (let them hang loose) and install the Cable Set. Connect individual cables as indicated on the labels .
- Step 5.*** Connect one GPIB cable from the lower (Dedicated) GPIB connector of the VNA to the upper synthesizer. Connect the second GPIB cable between the two synthesizers.
- Step 6.*** Insert the power cords into all 4 instruments and turn all the instruments on.
- Step 7.*** Ensure that the two synthesizers' GPIB addresses are set correctly. The top unit should be set to address 4 and the bottom unit should be set to address 5. This can be verified or changed by pressing **SYSTEM | CONFIG | GPIB ADDRESS** and entering the appropriate GPIB address.



**Figure 14-3.** ME7808C Console Rear Panel Cabling

**14-4 INITIAL ELECTRICAL TESTS**

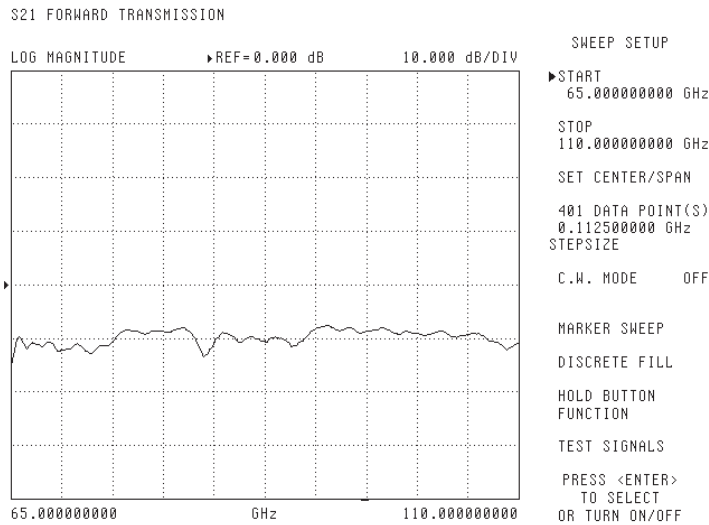
Perform electrical tests as described below:

**Millimeter Module Checkout**

Check out the Millimeter Modules as described below:

- Step 1.** Ensure the VNA displays “Self-Test Passed”. If self-test fails, contact your Anritsu Representative.
- Step 2.** To put the system into the “Millimeter” mode, press the Option Menu key, and select **TEST SET CONFIG / MILLIMETER WAVE**, then press Enter. Select the correct WR modules for your system.
- Step 3.** Connect the Port 1 and Port 2 3742A-EW waveguide test ports tightly together.
- Step 4.** If error messages appear, or the system does not sweep:
- Look for error messages displayed on the synthesizers’ front panels (“ovn cold” is not an error)
  - Double-check all cable connections
  - Verify the synthesizers’ GPIB addresses are set correctly
  - Verify the power control verniers on top of the 3742A-EW modules are set to maximum power (fully CW)
- Step 5.** Ensure the system is set to default settings (press the Default Program key twice to reset the system).
- Step 6.** Set the VNA display as follows:
- a. Press the Channel Menu key and select **SINGLE CHANNEL** from the display menu.
  - b. Press the Ch3 key
  - c. Press the Graph Type key and select **LOG MAGNITUDE** from the displayed menu.
- Step 7.** Ensure the display is similar to Figure 14-4 (next page).
- Step 8.** Press the Ch2 key.
- Step 9.** Press the Graph Type key and select **LOG MAGNITUDE** from the displayed menu.

**Step 10.** Ensure the display resembles Figure 14-4.

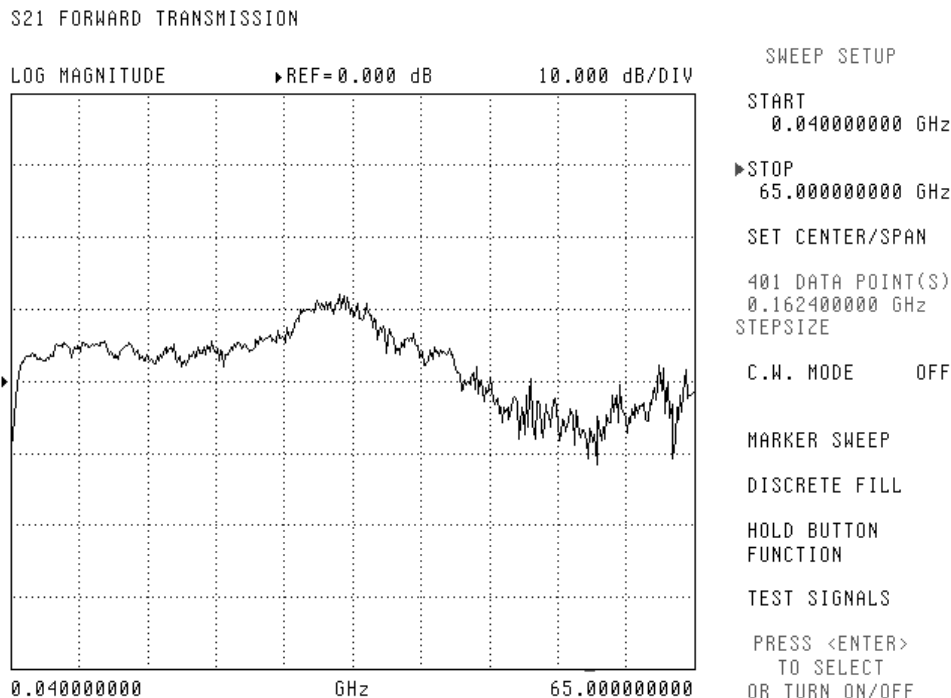


**Figure 14-4.** Normal S21 Display of MM Module Uncalibrated Transmission

**40 MHz to 65 GHz Checkout**

Checkout the 40 MHz to 65 GHz range as described below.

- Step 1.** Install a throughline between the test ports on the VNA.
- Step 2.** Disconnect the cables from the rear panel of the VNA that connect to the Test Set. Install the four small terminations, which are hanging from the chains, to the VNA.
- Step 3.** Press the Option Menu key and select **TEST SET CONFIG / INTERNAL** from the displayed menu.
- Step 4.** View single channel S21 and S12 as described above and verify that the traces are similar in appearance to Figure 14-6 on the following page.



**Figure 14-5.** S21 or S12 Forward Transmission

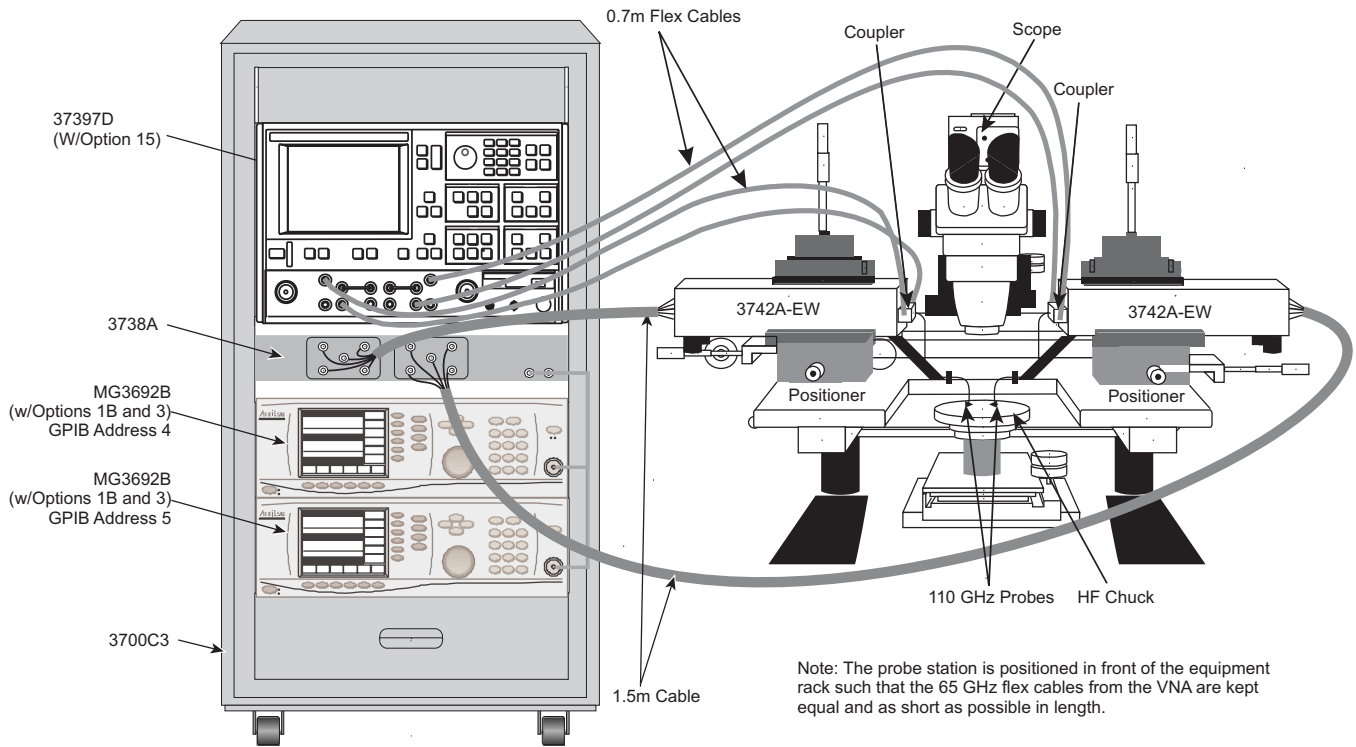
The preliminary checkout is complete. (Coupler operation can be checked using the wafer probe station).

You are now ready to install the system to the wafer probe station or configure it to your needs. To activate the full 40 GHz to 110 GHz sweep, press the Option Menu key, and select **BROADBAND**.

**14-5 WAFER PROBE STATION**

The ME7808C VNA can be integrated with any standard probe station (manual or semi-automatic) for making on-wafer measurements of active or passive components to 110 GHz. However, there are some considerations for set-up that will ensure accurate and repeatable measurements.

Figure 14-6 (following page) shows integration of the ME7808C VNA with a probe station. The primary connection is from the W1 (1.00 mm) coaxial output on the multiplexing coupler to the wafer probes. If losses through the probes and cables are excessive, the result can be a poor calibration. Therefore, it is recommended that the distance between the couplers and the probes be kept as small as possible. This can be achieved by mounting the millimeter wave modules (3742A-EW) on top of the positioners, as shown in the following figure.



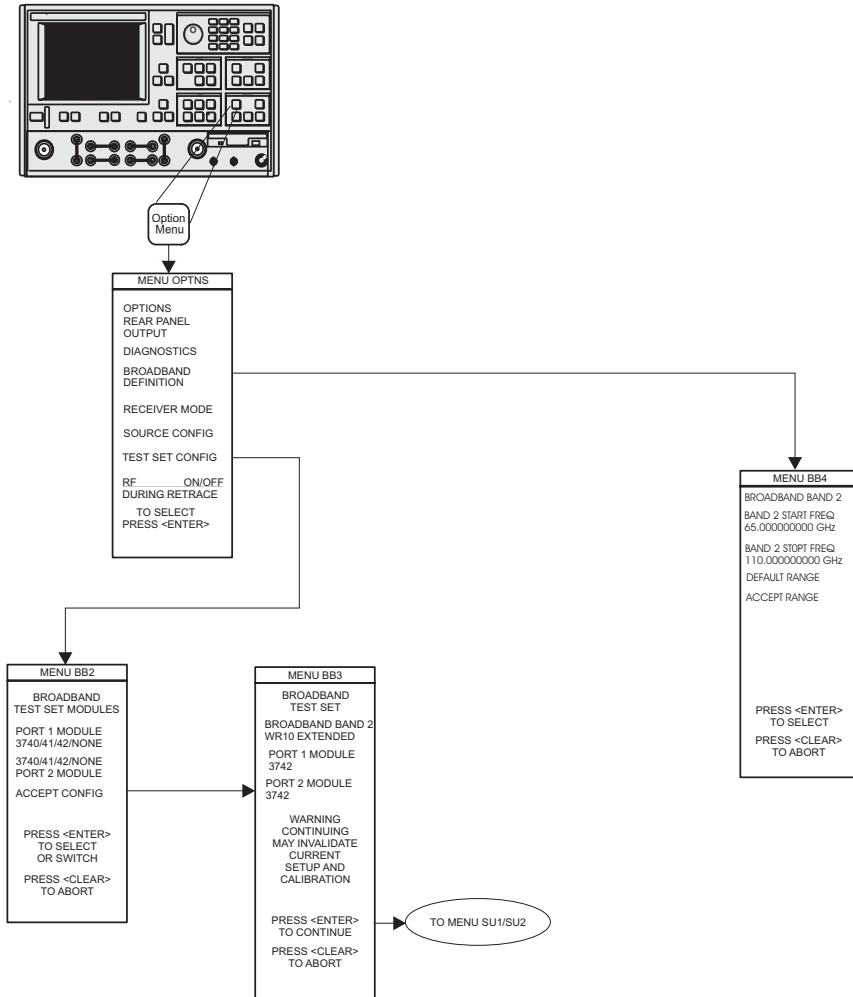
**Table 14-6.** Probe Station Interconnection

This results in increased output power and hence, enhanced system dynamic range. This concern also applies for the V-connector cables that connect the 37397D VNA to the multiplexing couplers. Placing the probe station directly in front of the ME7808C can minimize these cable lengths. Note that the probe station is shown on the side of the rack simply for clarity purposes.

For more information on wafer probe station integration, please contact Anritsu at 1-800-ANRITSU.

**14-6** BROADBAND MENUS, FLOW

The menus associated with the broadband system are shown in Figure 14-7.



**Table 14-7.** Broadband System Menu Flow

**14-7 BROADBAND CALIBRATION**

Broadband coaxial calibrations on the ME7808C are performed using the W1 calibration kit (3656). The most accurate calibration can be achieved during two separate calibrations, an SOLT from 40 MHz to 65 GHz and an SSST from 65 GHz to 110 GHz. Once the SOLT and SSST calibrations have been performed and saved, they can be merged for a continuous, single sweep broadband calibration. (Refer to Chapter 7, Measurement Calibration for SOLT and SSST calibration procedures.) Alternatively, the user may perform an SOLT over the entire band, 40 MHz to 110 GHz, which will result in degraded performance, compared to the previously mentioned routine.

**Merging Calibrations**

Procced as follows:

- Step 1.** Press the Appl key.
- Step 2.** Select **MERGE CAL FILES** to open menu MRG1 (left).
- Step 3.** Select **MERGE CAL FILES** again to open menu MRG2 (below left).
- Step 4.** Select **READ CAL FILE 1 FROM HARD DISK** or **READ CAL FILE 1 FROM FLOPPY DISK** to select the SOLT calibration file.
- Step 5.** After loading the SOLT cal file, select **READ CAL FILE 2 FROM HARD DISK** or **READ CAL FILE 2 FROM FLOPPY DISK** from menu MRG3 (below right) and select the SSST calibration file. This step merges the calibration files together.

MENU MRG1
MERGE CAL FILES
CAL FILES MUST EXIST IN THE CURRENT DIRECTORY
MERGE CAL FILES
PRESS <ENTER> TO SELECT

MENU MRG2
MERGE CAL FILES
READ CAL FILE 1 FROM HARD DISK
READ CAL FILE 1 FROM FLOPPY DISK
PRESS <ENTER> TO SELECT
PRESS <CLEAR> TO ABORT

MENU MRG3
MERGE CAL FILES
READ CAL FILE 2 FROM HARD DISK
READ CAL FILE 2 FROM FLOPPY DISK
PRESS <ENTER> TO SELECT
PRESS <CLEAR> TO ABORT

- Step 6.** The system is now ready for calibrated measurements over the 40 MHz to 110 GHz frequency range.



# ***Appendix A Front Panel Menus, Alphabetical Listing***

## ***Contents***

---

Menu ACAL, AutoCal Menu. . . . .	A-12
Menu ACAL_SETUP, AutoCal Setup Menu . . . . .	A-13
Menu ACAL_S11 1 PORT, AutoCal S11 1 Port Menu . . . . .	A-14
Menu ACAL_S22 1 PORT, AutoCal S22 1 Port Menu . . . . .	A-15
Menu ACAL_FULL, AutoCal Full Menu . . . . .	A-16
Menu ACAL_AR, AutoCal Adapter Removal Menu . . . . .	A-17
Menu ACAL_UTILS, AutoCal Utilities Menu . . . . .	A-18
Menu ACAL_CHAR, AutoCal Characterization Menu. . . . .	A-19
Menu APPL, Applications Menu . . . . .	A-20
Menu BB2, Broadband Select Menu1. . . . .	A-21
Menu BB3, Broadband Select Menu 2 . . . . .	A-22
Menu BB4, Broadband Select Menu3. . . . .	A-23
Menu BW1 or CAL_BW1, Select Video Bandwidth . . . . .	A-24
Menu C1, Select Calibration Data Points. . . . .	A-25
Menu C2, Frequency Range of Calibration (Start/Stop) . . . . .	A-26
Menu C2_CENTER, Frequency Range of Calibration (Center/Span) . . . . .	A-27
Menu C2A, Insert Individual Frequencies . . . . .	A-28
Menu C2C, Calibration Range—Harmonic Cal for Time Domain . . . . .	A-29
Menu C2B, Single Point Calibration . . . . .	A-29
Menu C2D, Fill Frequency Ranges . . . . .	A-30
Menu C3, Confirm Calibration Parameters. . . . .	A-31
Menu C3A, Confirm Calibration Parameters. . . . .	A-32
Menu C3B, Confirm Calibration Parameters. . . . .	A-33
Menu C3C, Confirm Calibration Parameters. . . . .	A-34

Menu C3D, Confirm Calibration Parameters. . . . .	A-35
Menu C3E, Confirm Calibration Parameters. . . . .	A-36
Menu C3F, Confirm Calibration Parameters. . . . .	A-37
Menu C3G, Confirm Calibration Parameters. . . . .	A-38
Menu C3H, Confirm Calibration Parameters. . . . .	A-39
Menu C3I, Confirm Calibration Parameter 2 . . . . .	A-40
Menu C3J, Confirm Calibration Parameter 3 . . . . .	A-41
Menu C4_P1/C4_P2, Select Connector Type . . . . .	A-42
Menu C4A_P1/C4A_P2, Select Connector Type . . . . .	A-43
Menu C4B, Select Open and Short Type . . . . .	A-44
Menu C5, Select Calibration Type . . . . .	A-45
Menu C5A, Select 1 Path 2 Port Calibration Type . . . . .	A-46
Menu C5B, Select Transmission Freq Response Calibration Type . . . . .	A-46
Menu C5C, Select Reflection Only Calibration Type . . . . .	A-47
Menu C5D, Select Use of Isolation . . . . .	A-47
Menu C6, Select Load Type . . . . .	A-48
Menu C6A, Enter Broadband Load Impedance. . . . .	A-48
Menu C6B, Enter Broadband Load Impedance. . . . .	A-48
Menu C7-Series, Begin Calibration Sequence . . . . .	A-49
Menu C8, Slide Load to Position X . . . . .	A-49
Menu C9A, Connect Device 1, Line . . . . .	A-50
Menu C9, Connect Throughline . . . . .	A-50
Menu C9C, Connect Device 2, Line . . . . .	A-51
Menu C9B, Connect Device 2, Line/Lowband. . . . .	A-51
Menu C11, Begin Calibration . . . . .	A-52
Menu C11A, Select Calibration Method . . . . .	A-53
Menu C12_P1/C12_P2, Enter the Capacitance Coefficients for Open Devices . . . . .	A-54
Menu C12A_P1/C12A_P2, Enter the Offset Length . . . . .	A-55
Menu C13, Set Reflection Pairing Menu . . . . .	A-56
Menu C13A, Set Reflection Pairing Menu . . . . .	A-57
Menu C13B, Set Reflection Pairing Menu . . . . .	A-57
Menu C14, Select Port X Offset Short Connector Type. . . . .	A-58
Menu C14A, Select Port X Offset Short. . . . .	A-58

Menu C15, Select Waveguide Kit to Use . . . . .	A-59
Menu C15A, Enter Waveguide Parameters . . . . .	A-60
Menu C15B, Enter Waveguide Parameters . . . . .	A-60
Menu C15C, Select Waveguide Kit to Use . . . . .	A-61
Menu C15D, Enter Waveguide Parameters . . . . .	A-62
Menu C16A, Enter Microstrip Parameters . . . . .	A-63
Menu C16, Select Microstrip Parameters . . . . .	A-63
Menu C17, Enter Line Impedance . . . . .	A-64
Menu C18, Change LRL/LRM Parameters . . . . .	A-64
Menu C18A, Change LRL/LRM Parameters . . . . .	A-65
Menu C18B, Change LRL/LRM Parameters—Two Band Calibration. . . . .	A-66
Menu C19, Change LRL/LRM Parameters . . . . .	A-67
Menu C20, Change Through Parameters . . . . .	A-68
Menu C21A, Port X Offset Short 1 . . . . .	A-69
Menu C21B, Port X Offset Short 2 . . . . .	A-70
Menu C21C, Port X Offset Short 3 . . . . .	A-71
Menu Cal_Completed . . . . .	A-72
Menu Cal_Applied . . . . .	A-73
Menu Cal_EM, Enhancement Menu for Calibration . . . . .	A-74
Menu CAR1, Adapter Removal 1 . . . . .	A-75
Menu CAR2, Adapter Removal 2 . . . . .	A-75
Menu EXT_CAR, Adapter Removal Help Menu . . . . .	A-76
Menu CAR3, Adapter Removal 3 . . . . .	A-77
Menu CAR4, Adapter Removal 4 . . . . .	A-77
Menu CM, Select Display Mode . . . . .	A-78
Menu DE1, E/O Measurement . . . . .	A-79
Menu EXT_DE1, E/O Measurement . . . . .	A-79
Menu DE2, O/E Measurement . . . . .	A-80
Menu EXT_DE2, O/E Measurement . . . . .	A-80
Menu DE3, E/O Measurement . . . . .	A-81
Menu DE3A, E/O Measurement. . . . .	A-81
Menu DE4, De-embed Network . . . . .	A-82
Menu DE4A, De-embed Network . . . . .	A-82

Menu DE5, De-embed O/E S2P . . . . .	A-83
Menu DE5A, De-embed O/E S2P . . . . .	A-83
Menu DE6, Generate E/O S2P Characterization . . . . .	A-84
Menu DE7, O/E Measurement . . . . .	A-85
Menu DE7A, O/E Measurement. . . . .	A-85
Menu DE8, Embed/De-embed S2P File . . . . .	A-86
Menu EXT_DE8, Embed/De-embed S2P File . . . . .	A-87
Menu DE9, Embed/De-embed S2P File . . . . .	A-88
Menu DE9A, Embed/De-embed S2P File . . . . .	A-89
Menu DF1, Discrete Fill . . . . .	A-90
Menu DF2, Insert Individual Frequencies . . . . .	A-91
Menu DFLT, Default Program Selected. . . . .	A-92
Menu DG1, Diagnostics 1 . . . . .	A-93
Menu DG3, Diagnostics 3 . . . . .	A-94
Menu DG2, Troubleshooting. . . . .	A-94
Menu DSK_FD, Floppy Disk Utilities. . . . .	A-95
Menu DSK_HD, Hard Disk Utilities . . . . .	A-96
Menu DSK2, Select File to Read . . . . .	A-97
Menu DSK3, Select File to Overwrite. . . . .	A-98
Menu DSK6, Type of Files to Delete . . . . .	A-99
Menu DSK7, Select File to Delete . . . . .	A-100
Menu DSK8, Type of Files to Copy . . . . .	A-101
Menu DSK9, Select File to Copy . . . . .	A-102
Menu DSK10, Capture Tabular Data . . . . .	A-103
Menu DSK11, Format Floppy Disk . . . . .	A-103
Menu DSK12, Format Hard Disk . . . . .	A-103
Menu EM, Enhancement Menu . . . . .	A-104
Menu GC1, Swept Frequency Gain Compression. . . . .	A-105
Menu EXT_GC1, Gain Compression Help Menu 1 . . . . .	A-106
Menu GC2, Swept Power Gain Compression 1 . . . . .	A-107
Menu EXT_GC2, Gain Compression Help Menu 2 . . . . .	A-108
Menu GC3, Swept Power Gain Compression 2 . . . . .	A-109
Menu EXT_GC3, Gain Compression Help Menu 3 . . . . .	A-110

Menu GC4, Multiple Frequency Gain Compression 1 . . . . .	A-111
Menu GC4_ABORT, Multiple Frequency Gain Compression 2 . . . . .	A-111
Menu EXT_GC4, Gain Compression Help Menu 4 . . . . .	A-112
Menu GC_DF2, Swept Power Frequencies . . . . .	A-113
Menu EXT_GC_DF2, Gain Compression Help Menu . . . . .	A-114
Menu GC_NORM, Normalize S21 . . . . .	A-114
Menu GC_RCVR, Receiver Calibration . . . . .	A-115
Menu GC_SU2, Swept Power Gain Compression 2 . . . . .	A-116
Menu GC_SU8A, Calibrate for Linear Power . . . . .	A-117
Menu GC_SU8A-ABORT, Abort Calibrate for Linear Power . . . . .	A-118
Menu EXT_GC_SU8A, Gain Compression Help Menu . . . . .	A-118
Menu GC_S21OPT, S21 Options . . . . .	A-119
Menu GP5, Select Name . . . . .	A-120
Menu GP7, Display GPIB Status . . . . .	A-121
Menu GP8, Network Setup . . . . .	A-122
Menu GT1/CAL_GT1, Select Graph Type . . . . .	A-123
Menu GT2/CAL_GT2, Select Graph Type . . . . .	A-124
Menu L1, Set Limits—Magnitude and Phase . . . . .	A-125
Menu L2, Set Limits—Linear Polar . . . . .	A-126
Menu L3, Set Limits—Linear Polar/Smith Chart. . . . .	A-127
Menu L4, Set Limits—Log Magnitude. . . . .	A-128
Menu L5, Set Limits—Phase. . . . .	A-129
Menu L6, Set Limits—Log Polar. . . . .	A-130
Menu L7, Set Limits—Group Delay . . . . .	A-131
Menu L8, Set Limits—Linear Magnitude . . . . .	A-132
Menu L9, Set Limits—Linear Magnitude and Phase . . . . .	A-133
Menu L10, Set Limits—Real Values . . . . .	A-134
Menu L11, Set Limits—Imaginary Values . . . . .	A-135
Menu L12, Set Limits—Real and Imaginary Values . . . . .	A-136
Menu L13, Set Limits—SWR . . . . .	A-137
Menu L14, Set Limits—Power Out . . . . .	A-138
Menu LD1, Define Upper Limit Segment . . . . .	A-139
Menu LD2, Define Lower Limit Segmen . . . . .	A-140

Menu LF1, Set Limit Frequencies—Log Mag . . . . .	A-141
Menu LF2, Set Limit Frequencies—Phase . . . . .	A-142
Menu LF3, Set Limit Frequencies—Group Delay. . . . .	A-143
Menu LF4, Set Limit Frequencies—Linear Mag . . . . .	A-144
Menu LF5, Set Limit Frequencies—SWR . . . . .	A-145
Menu LF6, Set Limit Frequencies—Real . . . . .	A-146
Menu LF7, Set Limit Frequencies—Imaginary . . . . .	A-147
Menu LF8, Set Limit Frequencies—Power Out . . . . .	A-148
Menu LSX, Segmented Limits . . . . .	A-149
Menu LTST, Test Limits . . . . .	A-150
Menu M1, Set Markers . . . . .	A-151
Menu M2, Select $\Delta$ REF Marker . . . . .	A-152
Menu M3, Select Readout Marker . . . . .	A-153
Menu M4, Readout Marker . . . . .	A-154
Menu M5, Set $\Delta$ REF Marker Readout. . . . .	A-155
Menu M6, Marker X All Displayed Channels . . . . .	A-156
Menu M7, Search . . . . .	A-157
Menu M8, Filter Parameters . . . . .	A-158
Menu M8A, Filter Setup . . . . .	A-159
Menu M9, Marker Readout Functions. . . . .	A-160
Menu MMW1, Millimeter Wave Test Set Band . . . . .	A-161
Menu MMW2, Millimeter Wave Test Set Modules . . . . .	A-162
Menu MMW3, Millimeter Wave Test Set . . . . .	A-163
Menu MMW4, mm Wave Band. . . . .	A-164
Menu EXT_MMW4 . . . . .	A-165
Menu MRG1, Merge Calibration Menu . . . . .	A-166
Menu EXT_MRG1, Merge Calibration Menu . . . . .	A-166
Menu MRG2, Merge Calibration Menu . . . . .	A-167
Menu MRG3, Merge Calibration Menu . . . . .	A-167
Menu NO1, Trace Memory Functions . . . . .	A-168
Menu NO2, Select Trace Math. . . . .	A-169
Menu NO3, Trace Memory Disk Functions . . . . .	A-169
Menu NXN, NxN Solution . . . . .	A-170

Menu EXT_NXN, NxN Solution . . . . .	A-171
Menu OM1, Multiple Source Control Menu . . . . .	A-172
Menu OM1A, Source Lock Polarity Menu . . . . .	A-173
Menu OM2, Define Bands Menu. . . . .	A-174
Menu OM3, Edit System Equations . . . . .	A-175
Menu OPTNS, Select Options . . . . .	A-176
Menu ORP1, Rear Panel Output Control . . . . .	A-177
Menu ORP2, Select Output Mode . . . . .	A-178
Menu OTS1, Test Set Configuration. . . . .	A-178
Menu OTS2, Warning . . . . .	A-179
Menu PC1, Select Polar Chart Mode. . . . .	A-180
Menu PD1, Parameter Definition 1 . . . . .	A-181
Menu PD2, Parameter Ratio . . . . .	A-182
Menu PD3, Parameter Definition 2 . . . . .	A-183
Menu PL1, Plot Options . . . . .	A-184
Menu PL2, Select Plot Size. . . . .	A-185
Menu PL3, Select Pen Colors. . . . .	A-186
Menu PM1, Select Data Output Type . . . . .	A-187
Menu PM2, Data Output Headers . . . . .	A-188
Menu PM2A, Data Output Headers . . . . .	A-189
Menu PM3, Tabular Printer Output Format . . . . .	A-190
Menu PM3A, Graphical Printer Output Format . . . . .	A-191
Menu PM4, Disk Output Operations . . . . .	A-192
Menu PM4A, Disk File Options . . . . .	A-193
Menu PM5, Printer Type, Options . . . . .	A-194
Menu RCV1, Receiver Mode . . . . .	A-195
Menu RCV1_WARN, Standard Receiver Mode Warning . . . . .	A-195
Menu RCV2, User Defined Receiver Mode Menu . . . . .	A-196
Menu RCV2_WARN, User Defined Receiver Mode Warning . . . . .	A-197
Menu RCV3, Standard Receiver Mode Warning Menu . . . . .	A-198
Menu RCV4, User Defined Receiver Mode Warning Menu . . . . .	A-199
Menu RD1, Set Reference Delay . . . . .	A-200
Menu RD2, Set Dielectric Constant . . . . .	A-201

Menu SC, Source Configure . . . . .	A-202
Menu SP, Select S Parameter . . . . .	A-203
Menu SR1, Save/Recall Front Panel Information . . . . .	A-204
Menu SR2, Recall or Save . . . . .	A-205
Menu SR3, Save to Internal memory . . . . .	A-206
Menu SS1 or CAL_SS1, Set Scaling 1 . . . . .	A-207
Menu SS2 or CAL_SS2, Set Scaling 2 . . . . .	A-208
Menu SS3Z/SS3Y or CAL_SS3Z/CALSS3Y, Set Scaling 3 . . . . .	A-209
Menu SS4 or CAL_SS4, Set Scaling 4 . . . . .	A-210
Menu SS5 or CAL_SS5, Set Scaling 5 . . . . .	A-211
Menu SS6 or CAL_SS6, Set Scaling 6 . . . . .	A-212
Menu SS7 or CAL_SS7, Set Scaling 7 . . . . .	A-213
Menu SS8 or CAL_SS8, Set Scaling 8 . . . . .	A-214
Menu SS9 or CAL_SS9, Set Scaling 9 . . . . .	A-215
Menu SS10 or CAL_SS10, Set Scaling 10 . . . . .	A-216
Menu SS11 or CAL_SS11, Set Scaling 11 . . . . .	A-217
Menu SS12 or CAL_SS12, Set Scaling 12 . . . . .	A-218
Menu SS13 or CAL_SS13, Set Scaling 13 . . . . .	A-219
Menu SS14, Set Scaling 14. . . . .	A-220
Menu SU1, Sweep Setup 1 . . . . .	A-221
Menu SU1_CENTER, Sweep Setup 1 . . . . .	A-222
Menu SU2 or CAL_SU2, Sweep Setup 2. . . . .	A-223
Menu SU2A or CAL_SU2A, Sweep Setup 2A . . . . .	A-224
Menu SU3, Single-Point Measurement Setup . . . . .	A-225
Menu SU3A, Swept-Power Measurement Setup . . . . .	A-226
Menu SU4, Select Function for Hold Button . . . . .	A-227
Menu SU5, Frequency Marker Sweep . . . . .	A-228
Menu SU6, Frequency Marker C.W. . . . .	A-229
Menu SU8 or CAL_SU8, Calibrate For Flat Test Port Power. . . . .	A-230
Menu EXT_SU8 Flat Power Calibration Instructions . . . . .	A-231
Menu SU9, Number of Data Points . . . . .	A-232
Menu SU9A, Number of Data Points 2 . . . . .	A-233
Menu TD1, Domain (Frequency/Display) . . . . .	A-234



Menu TD2_LP_TIME, Lowpass Time Domain Setup . . . . .	A-235
Menu TD2_LP_DIST, Lowpass Distance Display Setup . . . . .	A-236
Menu TD2_BP_TIME, Bandpass Time Domain Setup . . . . .	A-237
Menu TD2_BP_DIST, Bandpass Distance Display Setup . . . . .	A-238
Menu TD3_BP, Bandpass Time Domain Setup . . . . .	A-239
Menu TD3_LP, Lowpass Time Domain Setup . . . . .	A-239
Menu TD4_TIME & TD4_DIST, Gate (Distance/Time) . . . . .	A-240
Menu TD5_WINDOW, Shape . . . . .	A-241
Menu TD5_GATE, Shape. . . . .	A-241
Menu TD6, Set D.C. Term for Low Pass Processing . . . . .	A-242
Menu TD7_TIME, Time Marker Sweep. . . . .	A-243
Menu TD7_DIST, Distance Marker Range . . . . .	A-244
Menu TRIG, Triggers Measurement. . . . .	A-245
Menu U1, Utility Menu. . . . .	A-246
Menu U2, Display Instrument State. . . . .	A-247
Menu U3, Calibration Component Utilities . . . . .	A-249
Menu EXT_U3, SSLT and SSST Waveguide Parameters. . . . .	A-249
Menu U4, Display Installed Calibration Components Information 1 . . . .	A-250
Menu EXT_U4, SOLT Calibration Kit Information. . . . .	A-251
Menu U4A, Display Installed Calibration Components Information 2 . . .	A-252
Menu U4B, Display Installed Calibration Components Information 3. . . .	A-253
Menu EXT_U4B, SSLT and SSST Calibration Kit Information . . . . .	A-254
Menu U5, Color Configuration. . . . .	A-255
Menu U5, Color Configuration. . . . .	A-256
Menu U6, Set Date/Time . . . . .	A-257
372XXD, 373XXD Rear Panel. . . . .	B-4
Pinout Diagram, GPIB and Dedicated GPIB Connectors . . . . .	B-6
Pinout Diagram, Printer Connector (1 of 2) . . . . .	B-7
Pinout Diagram, External I/O Connector (1 of 2) . . . . .	B-8
Pinout Diagram, External I/O Connector (2 of 2) . . . . .	B-9
Pinout Diagram, VGA IN/OUT Connector . . . . .	B-10
Pinout Diagram, Serial Port Connector . . . . .	B-11
Pinout Diagram, Test Set Control Out Connector (Option 12) . . . . .	B-12

Pinout Diagram, External SCSI-2 (Optional) . . . . . B-13

# ***Appendix A***

## ***Front Panel Menus,***

### ***Alphabetical Listing***

#### ***A-1 INTRODUCTION***

This appendix provides descriptions for all menu choices. Menus are arranged in alphabetical order by their name (C1, SU2, DSK1, etc.).

#### ***A-2 MENUS***

A listing of all of the menus contained in this appendix is provided in the contents section at the beginning of this appendix. This listing gives the menu's call sign, name, and page number.

MENU	DESCRIPTION	GPIB COMMAND
AUTOCAL		None
AUTOCAL TYPE XXXXXXXX	Indicates the current type of AutoCal setup.	ACF2P?
CHANGE AUTOCAL SETUP	Calls menu ACAL_SETUP, which lets you change the AutoCal setup.	None
START AUTOCAL	Calls menu CAL_SEQ, which starts the AutoCal calibration sequencing immediately using the current AutoCal setup.	None
THRU UPDATE		None
CONNECT THROUGH LINE BETWEEN PORTS 1 AND 2	Instruction for connecting the AutoCal to the VNA for Thru Update.	None
NUMBER OF AVGS XXX	Enter the number of averages to be used during the Thru Update process (default 4 averages).	ACTUAVG; ACTUAVG?
START THRU UPDATE	Calls menu CAL_SEQ, which starts the Thru calibration update.	BEGTU
PRESS <ENTER> TO SELECT OR SWITCH	Press the Enter key to select or switch.	None

*Menu ACAL, AutoCal Menu*

MENU	DESCRIPTION	GPIB COMMAND
AUTOLOCAL SETUP		None
LINE TYPE COAXIAL/WAVEGUIDE	Switch between the line type used with the AutoCal module.	LTC; LTW; LTX?
WAVEGUIDE CUTOFF XX.XXXXXX GHz	Enter the Waveguide Cutoff frequency if the Waveguide Line Type is selected.	WCO; WCO?
SWITCH AVERAGING XXXX	Enter an appropriate amount of SWITCH AVERAGING (recommend 4 for the electronic modules, and 16 for the electromechanical modules).	ACSW; ACSW?
NUMBER OF AVGS		None
REFLECTION XXXX	Enter the number of averages to be used with the reflection standards in the AutoCal module (default 10 averages).	ACRFL; ACRFL?
LOAD XXXX	Enter the number of averages to be used with the load standard in the AutoCal module (default 10 averages).	ACLO; ACLO?
THRU XXXX	Enter the number of averages to be used with the thru standard (default 4 averages).	ACTU; ACTU?
ISOLATION XXXX	Enter the number of averages to be used with the isolation standard in the AutoCal module (default 32 averages).	ACISO; ACISO?; ACIAF?; ACIAX?
AUTOLOCAL TYPES	Select the type of AutoCal calibration to perform.	
S11 1 PORT S22 1 PORT FULL 2 PORT ADAPTER REMOVAL	Calls menu ACAL_S11, for more setup. Calls menu ACAL_S22, for more setup. Calls menu ACAL_FULL, for more setup. Calls menu ACAL_AR, for more setup.	ACS11; ACX? ACS22; ACX? ACSF2P; ACX? ACADR; ACX?

*Menu ACAL\_SETUP, AutoCal Setup Menu*

MENU	DESCRIPTION	GPIB COMMAND
AUTOCAL S11 1 PORT		None
PORT 1 CONNECTION LEFT/RIGHT	Switch between the side of the AutoCal module which is connected to Port 1 (default LEFT).	ACL1R2; ACR1L2
TEST SIGNALS	Calls menu CAL_SU2, which lets you enter calibrate Flat Test Port Power or change source power(s) and attenuator settings.	None
START AUTOCAL	Calls menu CAL_SEQ, which starts the AutoCal calibration sequencing.	None
PRESS <ENTER> TO SELECT OR SWITCH	Press the Enter key to select or switch.	None

*Menu ACAL\_S11 1 PORT, AutoCal S11 1 Port Menu*

MENU	DESCRIPTION	GPIB COMMAND
AUTOCAL S22 1 PORT		None
PORT 2 CONNECTION LEFT/RIGHT	Switch between the side of the AutoCal module which is connected to Port 2 (default RIGHT).	ACR1L2; ACL1R2
TEST SIGNALS	Calls menu CAL_SU2, which lets you enter calibrate Flat Test Port Power or change source power(s) and attenuator settings.	None
START AUTOCAL	Calls menu CAL_SEQ, which starts the AutoCal calibration sequencing.	None
PRESS <ENTER> TO SELECT OR SWITCH	Press the Enter key to select or switch.	None

*Menu ACAL\_S22 1 PORT, AutoCal S22 1 Port Menu*

MENU	DESCRIPTION	GPIB COMMAND
AUTOCAL FULL 2 PORTS		None
ISOLATION AVERAGING		None
OMIT	Select to omit the isolation step.	ACOMIT
DEFAULT	Select to use the Default value during the isolation step.	ACDEF
AVERAGING FACTOR XXXX	Select for user defined averaging factor during the isolation step.	ACIAF; ACIAF?
THRU TYPE CALIBRATION/TRUE	Switch between the Thru in the AutoCal module (CALIBRATOR) and your own port-to-port Thru (TRUE) to be use in the Thru Update (default CALIBRATOR).	ACF2TT; ACF2TC; ACF2TX?
PORT CONFIG L=1, R=2 R=1, L=2	Switch between the side of the AutoCal module which is connected to Port 1 and Port 2 (default LEFT connected to Port 1, RIGHT connected to Port 2).	ACL1R2; ACRIL2
TEST SIGNALS	Calls menu CAL_SU2, which lets you enter calibrate Flat Test Port Power or change source power(s) and attenuator settings.	None
START AUTOCAL	Calls menu CAL_SEQ, which starts the AutoCal calibration sequencing.	None
PRESS <ENTER> TO SELECT OR SWITCH	Press the Enter key to select or switch.	None

*Menu ACAL\_FULL, AutoCal Full Menu*



MENU	DESCRIPTION	GPIB COMMAND
AUTOCAL ADAPTER REMOVAL		None
ISOLATION AVERAGING		None
OMIT	Select to omit the isolation step.	ACOMIT
DEFAULT	Select to use the Default value during the isolation step.	ACDEF
AVERAGING FACTOR XXXX	Select for user defined averaging factor during the isolation step.	ACIAF
PORT CONFIG ADAPT & L=1, R=2 L=1, ADAPT&R=2 ADAPT&R=1, L=2 R=1, ADAPT & L=2	Switch between the side of the AutoCal module and adapter which is connected to Port 1 and Port 2 (default LEFT connected to Adapter which is then connected to Port 1, RIGHT connected to Port 2).	ACAL1R2; ACL1AR2; ACAR1L2; ACR1AL2; ACARP?
TEST SIGNALS	Calls menu CAL_SU2, which lets you enter calibrate Flat Test Port Power or change source power(s) and attenuator settings.	None
START AUTOCAL	Calls menu CAL_SEQ, which starts the AutoCal calibration sequencing.	None
PRESS <ENTER> TO SELECT OR SWITCH	Press the Enter key to select or switch.	None

*Menu ACAL\_AR, AutoCal Adapter Removal Menu*

MENU	DESCRIPTION	GPIB COMMAND
AUTOCAL UTILITIES		None
AUTOCAL CHARACTERIZATION	Calls menu ACAL_CHAR, which lets you set characterization values.	None
SAVE TO HARD DISK	Saves file to the hard disk.	SAVE
SAVE TO FLOPPY DISK	Saves file to the floppy disk.	SAVE
RECALL FROM HARD DISK	Recalls a file from the hard disk.	RECALL
RECALL FROM FLOPPY DISK	Recalls a file from the floppy disk.	RECALL
PRESS <ENTER> TO SELECT	Press the Enter key to select.	None

*Menu ACAL\_UTILS, AutoCal Utilities Menu*

MENU	DESCRIPTION	GPIB COMMAND
AUTOCAL CHARACTERIZATION		None
SWITCH AVERAGING XXXX	Enter an appropriate amount of SWITCH AVERAGING (recommend 4 for the electronic modules, and 16 for the electromechanical modules).	ACSW; ACSW?
PORT CONFIG L=1, R=2 R=1, L=2	Switch between the side of the AutoCal module which is connected to Port 1 and Port 2 (default LEFT connected to Port 1, RIGHT connected to Port 2).	ACL1R2; ACR1L2; ACARP?
NUMBER OF AVGS		None
REFLECTION XXXX	Enter the number of averages to be used with the reflection standards in the AutoCal module (default 10 averages).	ACRFL; ACRFL?
LOAD XXXX	Enter the number of averages to be used with the load standard in the AutoCal module (default 10 averages).	ACLO; ACLO?
THRU XXXX	Enter the number of averages to be used with the thru standard (default 4 averages).	ACTUAVG; ACTUAVG?
ISOLATION XXXX	Enter the number of averages to be used with the isolation standard in the AutoCal module (default 32 averages).	ACISO; ACISO?
START AUTOCAL CHARACTERIZATION	Calls menu CAL_SEQ, which starts the AutoCal characterization sequencing.	None
PRESS <ENTER> TO SELECT OR SWITCH	Press the Enter key to select or switch.	None

*Menu ACAL\_CHAR, AutoCal Characterization Menu*

MENU	DESCRIPTION	GPIB COMMAND
APPLICATIONS		None
ADAPTER REMOVAL	Calls menu CAR1, which provides options for removing an adapter.	None
SWEPT FREQUENCY GAIN COMPRESSION	Calls menu GC1, which provides options for gain compression.	None
SWEPT POWER GAIN COMPRESSION	Calls menu GC2, which provides options for gain compression.	None
NxN SOLUTION	Calls menu NXN, which lets users select between three pairs of devices. They can then solve for the characteristics of one of the pairs using the NxN simultaneous equation technique.	None
E/O MEASUREMENT	Calls menu DE1 and EXT_DE1, which provide information and options for the E/O measurement application.	None
O/E MEASUREMENT	Calls menu DE2 and EXT_DE2, which provide information and options for the O/E measurement application.	None
EMBED/DE-EMBED	Calls menu DE8, which lets users select files to embed.	None
MERGE CAL FILES	Calls menu MRG1.	None
PRESS <ENTER> TO SELECT	Pressing the ENTER key implements your selection.	None

*Menu APPL, Applications Menu*

MENU	DESCRIPTION	GPIB COMMAND
BROADBAND TEST SET MODULES		BDMM
PORT 1 MODULE 3740/41/42/NONE	Switch selection for port 1 module. The 3742 is standard for Broadband systems.	P1MMT; P1MMR; P1MMA;P1MMN; P1MMX?
PORT 2 MODULE 3740/41/42/NONE	Switch selection for port 2 module. The 3742 is standard for Broadband systems.	P2MMT; P2MMR; P2MMA;P2MMN; P2MMX?
ACCEPT CONFIG	Calls menu BB3.	None
PRESS <ENTER> TO SELECT OR SWITCH	Press the Enter key to select or switch.	None
PRESS <CLEAR> TO ABORT	Press the Clear key to abort the selection.	None

*Menu BB2, Broadband Select Menu1*

MENU	DESCRIPTION	GPIB COMMAND
BROADBAND TEST SET		SELBB
BROADBAND BAND 2 WR10 EXTENDED	Provides information for selections made in menu BB2 (previous menu).	None
PORT 1 MODULE 3742		P1MMT; P1MMR; P1MMA;P1MMN; P1MMX?
PORT 2 MODULE 3742		P2MMT; P2MMR; P2MMA;P2MMN; P2MMX?
WARNING CONTINUING MAY INVALIDATE CURRENT SETUP AND CALIBRATION		None
PRESS <ENTER> TO CONTINUE	Implements your broadband selection and calls menu SU1 or SU3.	None
PRESS <CLEAR> TO ABORT	Pressing the Clear key aborts your broadband system selection and calls menu OST1.	None

*Menu BB3, Broadband Select Menu 2*

MENU	DESCRIPTION	GPIB COMMAND
BROADBAND BAND 2		None
BAND 2 START FREQ 65.000000000 GHz	Displays the band 2 start frequency (fixed value).	BST?
BAND 2 STOP FREQ 110.000000000 GHz	Displays the band 2 stop frequency.	BSP; BSP?
DEFAULT RANGE	Restores the broadband band 2 frequency range to default.	None
ACCEPT RANGE	Accepts the new broadband band 2 frequency range.	SVBMM
PRESS <ENTER> TO SELECT	Implements your broadband selection.	None
PRESS <CLEAR> TO ABORT	Aborts your broadband selection and calls menu SU1 or SU3.	None

*Menu BB4, Broadband Select Menu3*

MENU	DESCRIPTION	GPIB COMMAND
SELECT VIDEO BANDWIDTH		None
MAXIMUM (10 kHz)	Selects video bandwidth to be 10 kHz.	IF4; IFX?
NORMAL (1 kHz)	Selects video bandwidth to be 1 kHz.	IF3; IFN; IFX?
REDUCED (100 Hz)	Selects video bandwidth to be 100 Hz.	IF2; IFR; IFX?
MINIMUM (10 Hz)	Selects video bandwidth to be 10 Hz.	IF1; IFM; IFX?
PRESS <ENTER> TO SELECT AND RESUME CAL	Pressing the ENTER key implements your selection. The "AND RESUME CAL" text appears when menu is accessed during calibration.	None

*Menu BW1 or CAL\_BW1, Select Video Bandwidth*



MENU	DESCRIPTION	GPIB COMMAND
SELECT CALIBRATION DATA POINTS		None
NORMAL (1601 POINTS MAXIMUM)	Selects the standard calibration from a start to a stop frequency that provides for up to 1601 equally spaced (except the last) points of data for the defined frequency range.	NOC
C.W. (1 POINT)	Selects the single frequency (C.W.) calibration sequence that provides for 1 data point at a selected frequency.	CWC
N-DISCRETE FREQUENCIES (2 TO 1601 POINTS)	Selects the discrete frequency calibration mode that lets you input a list of 2 to 1601 individual data point frequencies.	DFC
TIME DOMAIN (HARMONIC)	Selects the calibration mode for low-pass time-domain processing.	TDC
PRESS <ENTER> TO SELECT	Pressing the ENTER key implements your selection.	None

*Menu C1, Select Calibration Data Points*

MENU	DESCRIPTION	GPIB COMMAND
FREQUENCY RANGE OF CALIBRATION		None
START XXX.XXXXXXXXXXGHz	Enter the sweep-start frequency for calibration. If you desire, you can change this frequency for your measurement when you reach menu SU1, which follows the final calibration menu. The only restriction is that your start measurement frequency be greater than or equal to your start calibration frequency.	SRT; SRT?
STOP XXX.XXXXXXXXXX GHz	Enter the sweep-stop frequency for calibration. Like the start frequency, this too can be changed for your measurement. The stop frequency must be lower than or equal to your stop calibration frequency. In other words, your measurement frequency span must be equal to or smaller than your calibration frequency span.	STP; STP?
SET CENTER/SPAN	Calls menu C2_CENTER, which lets you enter a center frequency and span range.	CNTR; SPAN
XXX DATA POINTS XXX.XXXXXXXXXXGHz STEPSIZE	The program automatically sets the step size, based on the selected start and stop frequencies. The step size will be the smallest possible (largest number of points up to a maximum of 1601), based on the chosen frequency span.	ONP
MAXIMUM NUMBER OF DATA POINT(S)  1601 MAX PTS 801 MAX PTS 401 MAX PTS 201 MAX PTS 101 MAX PTS 51 MAX PTS		NP1601 NP801 NP401 NP201 NP101 NP51
NEXT CAL STEP	Displays the next menu in the calibration sequence.	None
PRESS <ENTER> TO SELECT	Pressing the ENTER key implements your menu selection.	None

*Menu C2, Frequency Range of Calibration (Start/Stop)*

MENU	DESCRIPTION	GPIB COMMAND
CAL FREQ RANGE		None
CENTER XXX.XXXXXXXXXXGHz	Enter the center frequency for calibration. If you desire, you can change this frequency for your measurement when you reach menu SU1_CENTER, which follows the final calibration menu.	CNTR; CNTR?
SPAN XXX.XXXXXXXXXX GHz	Enter the span width for calibration. Like the start frequency, this too can be changed for your measurement.	SPAN; SPAN?
SET START/STOP	Calls menu C2, which lets you enter a start and stop frequency.	SRT; STP
XXX DATA POINTS XXX.XXXXXXXXXXGHz STEP SIZE	The program automatically sets the step size, based on the selected center and span frequencies. The step size will be the smallest possible (largest number of points up to a maximum of 1601), based on the chosen frequency span.	ONP
MAXIMUM NUMBER OF DATA POINT(S)  1601 MAX PTS 801 MAX PTS 401 MAX PTS 201 MAX PTS 101 MAX PTS 51 MAX PTS		NP1601 NP801 NP401 NP201 NP101 NP51
NEXT CAL STEP	Displays the next menu in the calibration sequence.	None
PRESS <ENTER> TO SELECT	Pressing the ENTER key implements your menu selection.	None

*Menu C2\_CENTER, Frequency Range of Calibration (Center/Span)*

MENU	DESCRIPTION	GPIB COMMAND
INSERT INDIVIDUAL FREQUENCIES		None
INPUT A FREQ, PRESS <ENTER> TO INSERT		DFQ
NEXT FREQ. XXX.XXXXXXXXXXGHZ	Move the cursor here and enter the next frequency for which you wish calibration data taken. If the AUTO INCR option is ON, pressing Enter automatically increments the calibration frequency by the interval in GHz that appears below the option.	None
XXXX FREQS. ENTERED, LAST FREQ WAS XXX.XXXXXXXXXXGHZ	Shows the number of frequencies that you have entered and reports the value of the last frequency entered.	None
AUTO INCR ON (OFF) XXX.XXXXXXXXXXGHZ	Move the cursor here and press ENTER to switch the Auto-Increment mode on or off. If AUTO INCR is on, you may enter the frequency spacing.	None
PREVIOUS MENU	Calls menu C2D.	None
PRESS <ENTER> TO SELECT OR TURN ON/OFF	Pressing Enter will cause actions as described above.	None

*Menu C2A, Insert Individual Frequencies*

MENU	DESCRIPTION	GPIB COMMAND
SINGLE POINT C.W. CALIBRATION		None
C.W. FREQ XXX.XXXXXXXXXXGHz	Move cursor here and enter the frequency for which calibration is to be done.	CWF; CWF?
NEXT CAL STEP	Move cursor here and press ENTER when finished.	None
PRESS <ENTER> TO SELECT	Pressing the Enter key implements your menu selection.	None

*Menu C2B, Single Point Calibration*

MENU	DESCRIPTION	GPIB COMMAND
CALIBRATION RANGE		None
HARMONIC CAL FOR TIME DOMAIN		None
START (STEP) XXX.XXXXXXXXXXGHz	Move cursor here to enter the desired start frequency. This frequency also will be used as the frequency increment.	SRT; SRT?
APPROXIMATE STOP XXX.XXXXXXXXXX GHz	Move the cursor here to enter the approximate desired stop frequency. The frequency will be adjusted to the nearest harmonic multiple of the start frequency.	APRXSTP?
USING ABOVE START AND STOP WILL RESULT IN XXX DATA POINTS XXX.XXXXXXXXXX GHz TRUE STOP FREQ	The program automatically indicates the number of data points and the true (harmonic) stop frequency.	ONP; STP?
NEXT CAL STEP	Move the cursor here and press Enter when finished.	None
PRESS <ENTER> TO SELECT	Pressing the Enter key implements your menu selection.	None

*Menu C2C, Calibration Range—Harmonic Cal for Time Domain*

MENU	DESCRIPTION	GPIB COMMAND
DISCRETE FILL		None
INPUT START, INCR, POINTS, THEN SELECT "FILL RANGE"	This menu is used to create one or more ranges of discrete equally spaced frequency points for calibration.	None
START FREQ XXX.XXXXXXXXXX GHz	Enter the first frequency of the range.	FRS; FRS?
INCREMENT XXX.XXXXXXXXXX GHz	Enter the increment (step size) between one frequency and the next.	FRI; FRI
NUMBER OF PTS XXXX POINT(S)	Enter the number of frequency points in the range.	FRP; FRP?
STOP FREQ XXX.XXXXXXXXXX GHz	Enter the stop frequency, in GHz.	None
FILL RANGE ( XXXX ENTERED)	Moving the cursor here and pressing ENTER fills the range and shows the number of frequencies selected (in NUMBER OF PTS above).	FIL
INDIVIDUAL FREQ INSERT	Calls menu C2A, which allows you to set the individual frequencies.	DFQ
CLEAR ALL	Clears all entries displayed above.	FRC
FINISHED NEXT CAL STEP	Calls menu C3, the next menu in the calibration sequence.	None
PRESS <ENTER> TO SELECT	Pressing the Enter key implements your menu selection.	None

*Menu C2D, Fill Frequency Ranges*

MENU	DESCRIPTION	GPIB COMMAND
CONFIRM CALIBRATION PARAMETERS	Used for SOST method and coaxial line type.	None
PORT 1 CONN XXXXXXXX	Calls menu C4_P1 or C4A_P1, which displays the Port 1 test port connector type to be used during OSL calibration. This should agree with the connector type that both your calibration components and the test device mate with. Move cursor here and press Enter to display menu used to change connector type.	None
PORT 2 CONN XXXXXXXX	Calls menu C4_P2 or C4A_P2, which displays the Port 2 test port connector type to be used during OSL calibration. This should agree with the connector type that both your calibration components and the test device mate with. Move cursor here and press Enter to display menu used to change connector type.	None
REFLECTION PAIRING XXXXXX	Calls menu C13, which lets you select the pairing (mixed or matched) for the types of reflection devices (open/short) that you will use on Ports 1 and 2 for calibration.	None
LOAD TYPE XXXXXXXX	Calls menu C6, which displays type of load selected for calibration—broadband fixed or sliding. Move cursor here and press ENTER to display menu used to change load type.	None
THROUGH LINE PARAMETERS	Calls menu C20, which lets you enter throughline parameters—including offset length and loss equation coefficients.	None
REFERENCE IMPEDANCE	Calls menu C17, which lets you choose the reference impedance value (1 $\mu\Omega$ to 1 k $\Omega$ ) for the devices connected to Ports 1 and 2 for calibration. Default value is 50 $\Omega$ .	None
TEST SIGNALS	Calls menu CAL_SU2, which lets you enter calibrate Flat Test Port Power or change source power(s) and attenuator settings.	None
START CAL	Starts the standard (OSL) calibration sequence using coaxial standards.	BEG
PRESS <ENTER> TO SELECT OR CHANGE	Pressing the Enter key implements your menu selection.	None

*Menu C3, Confirm Calibration Parameters*

MENU	DESCRIPTION	GPIB COMMAND
CONFIRM CALIBRATION PARAMETERS	Used for Offset-Short method and coaxial line type.	None
PORT 1 CONN W1-CONN (M)	Calls menu C14 to select a connector offset short kit for Port1.	None
PORT 2 CONN W1-CONN (M)	Calls menu C14 to select a connector offset short kit for Port2.	None
REFLECTION PAIRING XXXXXXXX	Calls menu C13A for a SSLT calibration or calls menu C13B for a SSST calibration, which lets you select the pairing (mixed or matched) for the types of reflection devices (open/short) that you will use on Ports 1 and 2 for calibration.	None
LOAD TYPE XXXXXXXX	Calls menu C6, which displays type of load selected for calibration—broadband, fixed, or sliding. Move cursor here and press Enter to display the menu used to change the load type.	None
THROUGH LINE PARAMETERS	Calls menu C20, which lets you enter throughline parameters—including offset length and loss equation coefficients.	None
REFERENCE IMPEDANCE	Calls menu C15, which lets you choose the reference impedance value (1 $\mu\Omega$ to 1 M $\Omega$ ) for the devices connected to Ports 1 and 2 for calibration. Default value is 50 $\Omega$ .	None
TEST SIGNALS	Calls menu CAL_SU2, which lets you enter calibrate Flat Test Port Power or change source power(s) and attenuator settings.	None
START CAL	Starts the offset-short calibration sequence using coaxial standards.	BEG
PRESS <ENTER> TO SELECT OR CHANGE	Pressing the Enter key implements your menu selection.	None

*Menu C3A, Confirm Calibration Parameters*



MENU	DESCRIPTION	GPIB COMMAND
CONFIRM CALIBRATION PARAMETERS	Used for Offset-Short method and waveguide line type.	None
WAVEGUIDE PARAMETERS XXXXXX	Calls menu C15, which lets you enter waveguide parameters.	None
REFLECTION PAIRING XXXXXX	Calls menu C13A for a SSLT calibration or calls menu C13B for a SSST calibration, which lets you select the pairing (mixed or matched) for the types of reflection devices (open/short) that you will use on Ports 1 and 2 for calibration.	None
LOAD TYPE XXXXXXXX	Calls menu C6, which displays type of load selected for calibration—broadband fixed or sliding. Load type does not appear for the SSST method.	None
THROUGH LINE PARAMETERS	Calls menu C20, which lets you enter throughline parameters—including offset length and loss equation coefficients.	None
TEST SIGNALS	Calls menu CAL_SU2, which lets you calibrate Flat Test Port Power or change source power(s) and attenuator settings.	None
START CAL	Starts the offset-short calibration sequence using waveguide standards.	BEG
PRESS <ENTER> TO SELECT OR CHANGE	Pressing the Enter key implements your menu selection.	None

*Menu C3B, Confirm Calibration Parameters*

MENU	DESCRIPTION	GPIB COMMAND
CONFIRM CALIBRATION PARAMETERS	Used for Offset-Short method and microstrip line type.	None
PORT 1 SHORTS USER DEFINED	Calls menu C14A to select an offset short kit for Port 1.	None
PORT 2 SHORTS USER DEFINED	Calls menu C14A to select an offset short kit for Port 2.	None
REFLECTION PAIRING XXXXXX	Calls menu C13A for a SSLT calibration or calls menu C13B for a SSST calibration, which lets you select the pairing (mixed or matched) for the types of reflection devices (open/short) that you will use on Ports 1 and 2 for calibration.	None
LOAD IMPEDANCES	Calls menu C6A, which lets you select an impedance type and/or enter an impedance value.	None
THROUGH LINE PARAMETERS	Calls menu C20, which lets you enter throughline parameters—including offset length and loss equation coefficients.	None
MICROSTRIP PARAMETERS XXXXXXXXXXXX	Calls menu C16, which lets you change microstrip parameters.	None
TEST SIGNALS	Calls menu CAL_SU2, which lets you enter calibrate Flat Test Port Power or change source power(s) and attenuator settings.	None
START CAL	Starts the offset-short calibration sequence using microstrip standards.	BEG
PRESS <ENTER> TO SELECT OR CHANGE	Pressing the Enter key implements your menu selection.	None

*Menu C3C, Confirm Calibration Parameters*

MENU	DESCRIPTION	GPIB COMMAND
CONFIRM CALIBRATION PARAMETERS	Used for SOLT method and microstrip line type.	None
PORT 1 OPEN/SHORT XXXXXXXXXX	Calls menu C4B, which is used to select an offset short kit for Port 1.	None
PORT 2 OPEN/SHORT XXXXXXXXXX	Calls menu C4B, which is used to select an offset short kit for Port 2.	None
REFLECTION PAIRING XXXXXXXXXX	Calls menu C13A for a SSLT calibration or calls menu C13B for a SSST calibration, which lets you select the pairing (mixed or matched) for the types of reflection devices (open/short) that you will use on Ports 1 and 2 for calibration.	None
LOAD IMPEDANCE XXXXXXXXXX	Calls menu C6A, which lets you select an impedance type and/or enter an impedance value.	None
THROUGH LINE PARAMETERS XXXXXXXXXX	Calls menu C20, which lets you enter throughline parameters—including offset length and loss equation coefficients.	None
MICROSTRIP PARAMETERS XXXXXXXXXX	Calls menu C16, which lets you change microstrip parameters.	None
TEST SIGNALS	Calls menu CAL_SU2, which lets you enter calibrate Flat Test Port Power or change source power(s) and attenuator settings.	None
START CAL	Starts the standard calibration sequence using microstrip standards.	BEG
PRESS <ENTER> TO SELECT OR CHANGE	Pressing the Enter key implements your menu selection.	None

*Menu C3D, Confirm Calibration Parameters*

MENU	DESCRIPTION	GPIB COMMAND
CONFIRM CALIBRATION PARAMETERS	Used for LRL/LRM method, coaxial line type.	None
LRL/LRM PARAMETERS	Calls menu C18, which lets you change LRL/LRM parameters.	None
REFERENCE IMPEDANCE	Calls menu C17, which lets you change the reference impedance of the coaxial line standard to other than 50 ohms (default).	None
TEST SIGNALS	Calls menu CAL_SU2, which lets you enter calibrate Flat Test Port Power or change source power(s) and attenuator settings.	None
START CAL	Starts the LRL/LRM calibration sequence using coaxial standards.	BEG
PRESS <ENTER> TO SELECT OR CHANGE	Pressing the Enter key implements your menu selection.	None

*Menu C3E, Confirm Calibration Parameters*

MENU	DESCRIPTION	GPIB COMMAND
CONFIRM CALIBRATION PARAMETERS	Used for LRL/LRM method, waveguide line type.	None
LRL/LRM PARAMETERS	Calls menu C18, which lets you change LRL/LRM parameters.	None
WAVEGUIDE CUTOFF FREQ	Calls menu 15B, which lets you enter a waveguide cutoff frequency.	None
TEST SIGNALS	Calls menu CAL_SU2, which lets you enter calibrate Flat Test Port Power or change source power(s) and attenuator settings.	None
START CAL	Starts the LRL/LRM calibration sequence using waveguide standards.	BEG
PRESS <ENTER> TO SELECT OR CHANGE	Pressing the Enter key implements your menu selection.	None

*Menu C3F, Confirm Calibration Parameters*

MENU	DESCRIPTION	GPIB COMMAND
CONFIRM CALIBRATION PARAMETERS	Used for LRL/LRM method, microstrip line type.	None
LRL/LRM PARAMETERS	Calls menu C18, which lets you change LRL/LRM parameters.	None
MICROSTRIP PARAMETERS USER DEFINED	Calls menu C16, which lets you change microstrip parameters.	None
TEST SIGNALS	Calls menu CAL_SU2, which lets you enter calibrate Flat Test Port Power or change source power(s) and attenuator settings.	None
START CAL	Starts the LRL/LRM calibration sequence using microstrip standards.	BEG
PRESS <ENTER> TO SELECT OR CHANGE	Pressing the Enter key implements your menu selection.	None

*Menu C3G, Confirm Calibration Parameters*

MENU	DESCRIPTION	GPIB COMMAND
CONFIRM CALIBRATION PARAMETERS		None
TRM REFLECT OFFSET LENGTH +XXX.XXX mmX	Enter the offset length of the TRM reflection.	TOL; TOL?; ROL; ROL?
TRM REFLECT TYPE		None
GREATER THAN $Z_0$	Specifies the reflection to have an impedance value greater than the reference impedance ( $Z_0$ ). This is typically an open device.	RGZ; RXZ?
LESS THAN $Z_0$	Selects the reflection to have an impedance value less than the reference impedance ( $Z_0$ ). This is typically a short device.	RLZ; RXZ?
TRM MATCH IMPEDANCE	Calls menu C6B, which lets you change the match impedance of the coaxial line standard to other than 50 $\Omega$ (default).	None
REFERENCE IMPEDANCE	Calls menu C17, which lets you change the reference impedance of the coaxial line standard to other than 50 $\Omega$ (default).	None
TEST SIGNALS	Calls menu CAL_SU2, which lets you enter calibrate Flat Test Port Power or change source power(s) and attenuator settings.	None
START CAL	Starts the standard calibration sequence using microstrip standards.	BEG
PRESS <ENTER> TO SELECT OR CHANGE	Pressing the Enter key implements your menu selection.	None

*Menu C3H, Confirm Calibration Parameters*

MENU	DESCRIPTION	GPIB COMMAND
CONFIRM CALIBRATION PARAMETERS		None
TRM REFLECT OFFSET LENGTH +XXX.XXX mmX	Enter the offset length of the TRM reflection.	TOL; TOL?; ROL; ROL?
TRM MATCH IMPEDANCE	Calls menu C6B, which lets you change the match impedance of the coaxial line standard to other than 50 $\Omega$ (default).	None
WAVEGUIDE CUTOFF FREQ	Calls menu 15B, which lets you enter a waveguide cutoff frequency.	None
TEST SIGNALS	Calls menu CAL_SU2, which lets you enter calibrate Flat Test Port Power or change source power(s) and attenuator settings.	None
START CAL	Starts the standard calibration sequence using microstrip standards.	BEG
PRESS <ENTER> TO SELECT OR CHANGE	Pressing the Enter key implements your menu selection.	None

*Menu C3I, ConfirmCalibration Parameter 2*



MENU	DESCRIPTION	GPIB COMMAND
CONFIRM CALIBRATION PARAMETERS		None
TRM REFLECT OFFSET LENGTH +XXX.XXX mmX	Enter the offset length of the TRM reflection.	TOL; TOL?; ROL; ROL?
TRM REFLECT TYPE		None
GREATER THN $Z_0$	Specifies the reflection to have an impedance value greater than the reference impedance ( $Z_0$ ). This is typically an open device.	RGZ; RXZ?
LESS THAN $Z_0$	Selects the reflection to have an impedance value less than the reference impedance ( $Z_0$ ). This is typically a short device.	RLZ; RXZ?
TRM MATCH IMPEDANCE	Calls menu C6B, which lets you change the match impedance of the coaxial line standard to other than 50 $\Omega$ (default).	None
MICROSTRIP PARAMETERS XXXXXXX	Calls menu C16 or 16A, which lets you change microstrip parameters.	None
TEST SIGNALS	Calls menu CAL_SU2, which lets you enter calibrate Flat Test Port Power or change source power(s) and attenuator settings.	None
START CAL	Starts the standard calibration sequence using microstrip standards.	BEG
PRESS <ENTER> TO SELECT OR CHANGE	Pressing the Enter key implements your menu selection.	None

*Menu C3J, ConfirmCalibration Parameter 3*

MENU	DESCRIPTION	GPIB COMMAND
SELECT PORT X CONNECTOR TYPE	Applies the four capacitance-coefficient values to the Open and offset length to the Short. The data appears in the display area of the screen.	None
K-CONN (M)	Select for K-CONN (M) connector on Port X.	CMK; P1C?;P2C?
K-CONN (F)	Select for K-CONN (F) connector on Port X.	CFK; P1C?;P2C?
V-CONN (M)	Select for V-CONN (M) connector on Port X.	CMV; P1C?;P2C?
V-CONN (F)	Select for V-CONN (F) connector on Port X.	CFV; P1C?;P2C?
W1-CONN (M)	Select for W1-CONN (M) connector on Port X.	CM1; P1C?;P2C?
W1-CONN (F)	Select for W1-CONN (F) connector on Port X.	CF1; P1C?;P2C?
SMA (M)	Select for SMA (M) connector on Port X.	CMS; P1C?;P2C?
SMA (F)	Select for SMA (F) connector on Port X.	CFS; P1C?;P2C?
GPC-3.5 (M)	Select for GPC-3.5 (M) connector on Port X.	CM3; P1C?;P2C?
GPC-3.5 (F)	Select for GPC-3.5 (F) connector on Port X.	CF3; P1C?;P2C?
GPC-7	Select for GPC-7 connector on Port X.	CNG; P1C?;P2C?
USER DEFINED	Calls menu C12, which lets you specify the connector coefficients.	None
MORE	Calls menu C4A for additional connector types.	None
PRESS <ENTER> TO SELECT	Pressing the Enter key implements your menu selection.	None

*Menu C4\_P1/C4\_P2, Select Connector Type*

MENU	DESCRIPTION	GPIB COMMAND
SELECT PORT X CONNECTOR TYPE	Applies the four capacitance-coefficient values to the Open and offset length to the Short. The data appears in the display area of the screen.	None
TYPE N (M)	Select for TYPE N (M) connector on Port X.	CMN; P1C?;P2C?
TYPE N (F)	Select for TYPE N (F) connector on Port X.	CFN; P1C?;P2C?
TYPE N (M) 75Ω	Select for Type N (M) 75Ω connector on Port X.	CMN75; P1C?; P2C?
TYPE N (F) 75Ω	Select for Type N (F) 75Ω connector on Port X.	CFN75; P1C?;P2C?
7/16 (M)	Select for 7/16 (M) connector on Port X.	CM7; P1C?;P2C?
7/16 (F)	Select for 7/16 (F) connector on Port X.	CF7; P1C?;P2C?
TNC (M)	Select for TNC (M) connector on Port X.	CMC; P1C?;P2C?
TNC (F)	Select for TNC (F) connector on Port X.	CFC; P1C?;P2C?
2.4 mm (M)	Select for 2.4 mm (M) connector on Port X.	CM2; P1C?;P2C?
2.4 mm(F)	Select for 2.5 mm (F) connector on Port X.	CF2; P1C?;P2C?
SPECIAL (M)	Select for Special (M) connector on Port X.	CMSP; P1C?;P2C?
SPECIAL (F)	Select for Special (F) connector on Port X.	CFSP; P1C?;P2C?
USER DEFINED	Calls menu C12, which lets you specify the connector coefficients.	None
MORE	Calls additional connector types to screen.	None
PRESS <ENTER> WHEN COMPLETE	Pressing the Enter key implements your menu selection.	None

*Menu C4A\_P1/C4A\_P2, Select Connector Type*

MENU	DESCRIPTION	GPIB COMMAND
SELECT PORT X OPEN & SHORT		None
SPECIAL (M) SPECIAL (F)		C12
USER DEFINED	Calls menu C12, which lets you specify the connector coefficients.	None
PRESS <ENTER> TO SELECT	Pressing the Enter key implements your menu selection.	None

*Menu C4B, Select Open and Short Type*

MENU	DESCRIPTION	GPIB COMMAND
SELECT CALIBRATION TYPE		None
FULL 12-TERM	Select calibration using all 12 error terms EDF, ESF, ERF, ETF, ELF, (EXF), EDR, ESR, ERR, ETR, FLR, (EXR).	C12
1 PATH 2 PORT	Calls menu C5A, which lets select a correction for forward- or reverse-direction error terms.	None
TRANSMISSION FREQUENCY RESPONSE	Calls menu C5B, which lets select a correction for frequency response error terms.	None
REFLECTION ONLY	Calls menu C5C, which lets select a correction for reflection-only error terms.	None
PRESS <ENTER> TO SELECT	Pressing the Enter key implements your menu selection.	None

*Menu C5, Select Calibration Type*

MENU	DESCRIPTION	GPIB COMMAND
SELECT 1 PATH 2 PORT CALIBRATION TYPE		None
FORWARD PATH (S11, S21)	For the calibration-correction of the forward transmission and reflection error term, ETF, EDF, ESF, ERF, (EXF).	C8T
REVERSE PATH (S12, S22)	For the calibration-correction of the reverse transmission and reflection error term, EDR, ESR, ERR, ETR, (EXR).	C8R
PRESS <ENTER> TO SELECT	Pressing the Enter key implements your selection.	None

*Menu C5A, Select 1 Path 2 Port Calibration Type*

MENU	DESCRIPTION	GPIB COMMAND
SELECT TRANSMISSION FREQ RESPONSE CALIBRATION TYPE		None
FORWARD PATH (S21)	For the calibration-correction of the forward transmission frequency-response error term, ETF. (EXF).	CFT; CXX?
REVERSE PATH (S12)	For the calibration-correction of the reverse transmission-frequency-response error term, ETR, (EXR).	CRT; CXX?
BOTH PATHS (S21, S12)	For the calibration-correction of the forward and reverse transmission-frequency-response error terms ETF, ETR, (EXF, EXR).	CBT; CXX?
PRESS <ENTER> TO SELECT	Pressing the Enter key implements your menu selection.	None

*Menu C5B, Select Transmission Freq Response Calibration Type*

MENU	DESCRIPTION	GPIB COMMAND
SELECT REFLECTION ONLY CALIBRATION TYPE		None
PORT 1 ONLY (S11)	For the calibration-correction of the forward reflection-only error terms EDF, ESF, ERF.	CRF; CXX?
PORT 2 ONLY (S22)	For the calibration-correction of the reverse reflection-only error terms EDR, ESR, ERR.	CRR; CXX?
BOTH PORTS (S11, S22)	For the calibration-correction of the forward and reverse reflection-only error terms EDF, ESF, ERF, EDR, ESR, ERR.	CRB; CXX?
PRESS <ENTER> TO SELECT	Pressing the Enter key implements your menu selection.	None

*Menu C5C, Select Reflection Only Calibration Type*

MENU	DESCRIPTION	GPIB COMMAND
SELECT USE OF ISOLATION IN CALIBRATION		None
INCLUDE ISOLATION (STANDARD)	Includes isolation term(s).	ISN; ISX?
EXCLUDE ISOLATION	Excludes isolation term(s).	ISF; ISX?
PRESS <ENTER> TO SELECT	Pressing the Enter key implements your menu selection.	None
PRESS <ENTER> TO SELECT	Pressing the ENTER key implements your selection.	

*Menu C5D, Select Use of Isolation*

MENU	DESCRIPTION	GPIB COMMAND
SELECT TYPE OF LOAD		None
BROADBAND FIXED LOAD	Selects calibration based on the broadband load being used, then calls menu C6A.	BBL; BBX?
SLIDING LOAD (MAY ALSO REQUIRE BROADBAND FIXED LOAD)	Selects calibration based on the sliding load being used. If your low-end frequency is below 2 GHz (4 GHz for V Connector), a fixed broadband load is also required.	SLD; BBX?
PRESS <ENTER> TO SELECT	Pressing the Enter key implements your menu selection.	None

*Menu C6, Select Load Type*

MENU	DESCRIPTION	GPIB COMMAND
BROADBAND LOAD PARAMETERS		None
IMPEDANCE XX.XXX $\Omega$	Enter the impedance of the load.	BBZ; BBZ?
INDUCTANCE XX.XXX pH	Enter the inductance of the load.	BBZL; BBZL?
PRESS <ENTER> WHEN COMPLETE	Pressing the Enter key implements your menu selection.	None

*Menu C6A, Enter Broadband Load Impedance*

MENU	DESCRIPTION	GPIB COMMAND
TRM MATCH PARAMETERS		None
IMPEDANCE XX.XXX $\Omega$	Allows entry of the impedance (defaults to 50.000 $\Omega$ ).	BBZ; BBZ?
INDUCTANCE XX.XXX pH	Allows entry of the inductance (defaults to 0.00 pH).	BBZL; BBZL?
PRESS <ENTER> WHEN COMPLETE	Pressing the Enter key implements your menu selection.	None

*Menu C6B, Enter Broadband Load Impedance*



MENU	DESCRIPTION	GPIB COMMAND
CALIBRATION SEQUENCE		None
CONNECT CALIBRATION DEVICE(S)		None
PORT 1: XXXXXXXXXXXX	Connect the required component to Port 1.	None
PORT 2: XXXXXXXXXXXX	Connect the required component to Port 2.	None
PRESS <ENTER> TO MEASURE DEVICE(S)	Pressing the Enter key sequentially measures the devices connected to Ports 1 and 2, beginning with Port 1.	None
PRESS <1> FOR PORT 1 DEVICE	Pressing the 1 key, on the keypad, measures the device connected to Port 1.	None
PRESS <2> FOR PORT 2 DEVICE	Pressing the 2 key, on the keypad, measures the device connected to Port 2.	None

*Menu C7-Series, Begin Calibration Sequence*

MENU	DESCRIPTION	GPIB COMMAND
CALIBRATION SEQUENCE		None
SLIDE LOAD TO POSITION X	Slide the load to the next position, then press the Enter key. Moving the slide to six different positions provides sufficient data for the program to accurately calculate the effective directivity of the system.	None
PRESS <ENTER> TO MEASURE DEVICE (S)	Pressing the Enter key begins the measurement.	None

*Menu C8, Slide Load to Position X*

MENU	DESCRIPTION	GPIB COMMAND
CALIBRATION SEQUENCE		None
CONNECT THROUGHLINE XXXXX BETWEEN TEST PORTS	Connect Ports 1 and 2 together using the Throughline standard (zero or non-zero length).	None
PRESS <ENTER> TO MEASURE DEVICE(S)	Pressing the Enter key begins the measurement.	None

*Menu C9, Connect Throughline*

MENU	DESCRIPTION	GPIB COMMAND
CALIBRATION SEQUENCE		None
CONNECT DEVICE 1 LINE 1 (REF) XXXXX BETWEEN TEST PORTS	Prompts you to connect reference line 1 between test ports.	None
PRESS <ENTER> TO MEASURE DEVICE(S)	Pressing the Enter key begins the measurement.	None

*Menu C9A, Connect Device 1, Line*

MENU	DESCRIPTION	GPIB COMMAND
CALIBRATION SEQUENCE		None
CONNECT DEVICE 2 LINE/ LOWBAND MATCHES BETWEEN TEST PORTS	Connect device 2 between the test ports. This will be a LINE for LRL measurements or LOWBAND MATCHES for LRM measurements.	None
PRESS <ENTER> TO MEASURE DEVICE(S)	Pressing the Enter key begins the measurement.	None

*Menu C9B, Connect Device 2, Line/Lowband*

MENU	DESCRIPTION	GPIB COMMAND
CALIBRATION SEQUENCE		None
CONNECT DEVICE 2 LINE XXXXX BETWEEN TEST PORTS	Prompts you to connect the second line standard between the test ports.	None
PRESS <ENTER> TO MEASURE DEVICE(S)	Pressing the Enter key begins the measurement.	None

*Menu C9C, Connect Device 2, Line*

MENU	DESCRIPTION	GPIB COMMAND
BEGIN CALIBRATION		None
KEEP EXISTING CAL DATA	Keep existing calibration data.	KEC
REPEAT PREVIOUS CAL	Repeats the previous calibration.	RPC
AUTOCAL	Calls menu ACAL, which lets you choose AutoCal settings.	None
CAL METHOD XXXXXXX	Displays the calibration method that you have selected—standard, offset short or LRL/LRM.	CMX?
TRANSMISSION LINE TYPE: XXXXXXXX	Indicates type of transmission line currently selected, e. g. coaxial, waveguide, microstrip.	LTX?
CHANGE CAL METHOD AND LINE TYPE	Calls menu C11A, which allows you to change calibration method and transmission line type.	None
NEXT CAL STEP	Selects the next calibration step.	None
PRESS <ENTER> TO SELECT	Pressing the Enter key implements your menu selection.	None

*Menu C11, Begin Calibration*

MENU	DESCRIPTION	GPIB COMMAND
CHANGE CAL METHOD AND LINE TYPE		None
NEXT CAL STEP	Select next calibration step. Must move cursor to here after making below selections. Pressing the Enter key then moves you to the next step.	None
CAL METHOD		None
(SOLT) STANDARD	This option and the ones below allow you to select the method (procedure) to be used to calibrate. This method is independent of the calibration type, which may be 12-term, reflection only, etc.	SCM; CMX?
SSLT (DOUBLE OFFSET SHORT WITH LOAD)	Selects the double offset short calibration method.	OCM; CMX?
SSST (TRIPLE OFFSET SHORT)	Selects the triple offset short calibration method.	OC3M; CMX?
LRL/LRM	Selects LRL or LRM method.	LCM; CMX?
TRM	Selects TRM method.	TCM; CMX?
TRANSMISSION LINE TYPE		None
COAXIAL	Selects coaxial cable as the transmission line type.	LTC; LTX?
WAVEGUIDE	Selects waveguide as the transmission line type.	LTW; LTX?
MICROSTRIP	Selects microstrip as the transmission line type.	LTU; LTX?
PRESS <ENTER> TO SELECT	Pressing the Enter key implements your menu selection.	None

*Menu C11A, Select Calibration Method*

MENU	DESCRIPTION	GPIB COMMAND
PORT X OPEN DEVICE	Enter the capacitance-coefficient values needed to correct for your Open device. The capacitive phase shift of the Open is characterized by the equation: $C_{Open} = C_0 + (C_1 \times f) + (C_2 \times f^2) + (C_3 \times f^3)$	None
ENTER THE CAPACITANCE COEFFICIENTS		None
TERM 1-C0 $\pm XX.XXe-15$	Enter the term 1 coefficient value ( $\times 10^{-15}$ F).	CC0; CC0?
TERM 2-C1 $\pm XXX.XX e-27$	Enter the term 2 coefficient value ( $\times 10^{-27}$ F/Hz).	CC1; CC1?
TERM 3-C2 $\pm XXX.XX e-36$	Enter the term 3 coefficient value ( $\times 10^{-36}$ F/Hz <sup>2</sup> ).	CC2; CC2?
TERM 4-C3 $\pm XXX.XX e-45$	Enter the term 4 coefficient value ( $\times 10^{-45}$ F/Hz <sup>3</sup> ).	CC3; CC3?
ENTER THE OFFSET LENGTH	Enter the length of the offset.	COO
OFFSET LENGTH $\pm XX.XXXX$ mm	Select to enter and display offset length of Open.	COO?
PRESS <ENTER> WHEN COMPLETE	Pressing the Enter key calls C12A_P1/C12A_P2.	None

*Menu C12\_P1/C12\_P2, Enter the Capacitance Coefficients for Open Devices*

MENU	DESCRIPTION	GPIB COMMAND
PORT X SHORT DEVICE		None
ENTER THE INDUCTANCE COEFFICIENTS	Provide inductance term entries for the short device such that the frequency dependent inductance is $L(w) = L0 + (L1 * f) + (L2 * f^2) + (L3 * f^3)$ . These values default to zero. They are used in the standard calibration method in combination with the coaxial and microstrip line types. They are not used in the offset short and LRL/LRM calibration methods. The calibration kits provided by ANRITSU are not to support these terms.	None
TERM 1 - L0 - XXXX.XX e-12	Enter the term 1 value.	CL0; CL0?
TERM 2 - L1 - XXXX.XX e-24	Enter the term 2 value.	CL1; CL1?
TERM 3 - L2 - XXXX.XX e-33	Enter the term 3 value.	CL2; CL2?
TERM 4 - L3 - XXXX.XX e-42	Enter the term 4 value.	CL3; CL3?
ENTER THE OFFSET LENGTH	Enter the length of the offset device.	COS
OFFSET LENGTH -XXX.XXXX mm	Displays the offset length value.	COS?
PRESS <ENTER> WHEN COMPLETE	Pressing the Enter key implements your menu selection.	None

*Menu C12A\_P1/C12A\_P2, Enter the Offset Length*

MENU	DESCRIPTION	GPIB COMMAND
SET REFLECTION PAIRING		None
MIXED (OPEN–SHORT SHORT–OPEN)	Selects different reflection devices (open/short or short/open) to be connected to Ports 1 and 2 for the calibration sequencing.	MIX, MIX?
MATCHED (OPEN–OPEN SHORT–SHORT)	Selects the same type of reflection device (open/open or short/short) to be connected to Ports 1 and 2 for the calibration sequencing.	MAT, MIX?
PRESS <ENTER> TO SELECT	Pressing the Enter key implements your menu selection.	None

*Menu C13, Set Reflection Pairing Menu*



MENU	DESCRIPTION	GPIB COMMAND
SELECT REFLECTION PAIRING		None
MIXED (SHORT1-SHORT2, SHORT2-SHORT1)	Selects mixed reflection pairing.	MIX
MATCHED (SHORT1-SHORT1, SHORT2-SHORT2)	Selects matched reflection pairing.	MAT
PRESS <ENTER> TO SELECT	Pressing the Enter key implements your menu selection.	None

*Menu C13A, Set Reflection Pairing Menu*

MENU	DESCRIPTION	GPIB COMMAND
SELECT REFLECTION PAIRING		None
MIXED (SHORT1-SHORT2, SHORT2-SHORT3, SHORT3-SHORT1)	Selects mixed reflection pairing.	MIX
MATCHED (SHORT1-SHORT1, SHORT2-SHORT2, SHORT3-SHORT3)	Selects matched reflection pairing.	MAT
PRESS <ENTER> TO SELECT	Pressing the Enter key implements your menu selection.	None

*Menu C13B, Set Reflection Pairing Menu*

MENU	DESCRIPTION	GPIB COMMAND
SELECT PORT X OFFSET SHORT CONNCOCTR TYPE	Used with the coaxial line type.	None
W1-CONN (M) W1-CONN (F)	Selects W1(M) connector (kit) type on Port X. Selects W1 (F) connector (kit) type on Port X.	CM1 CF1 P1C?; P2C?
SPECIAL A (M) SPECIAL A (F)	Selects Special A (M) connector (kit) type on Port X. Selects Special A (F) connector (kit) type on Port X.	CMSPA CFSPA P1C?; P2C?
SPECIAL B (M) SPECIAL B (F)	Selects Special B (M) connector (kit) type on Port X. Selects Special B (F) connector (kit) type on Port X.	CMSPB CFSPB P1C?; P2C?
SPECIAL C (M) SPECIAL C (F)	Selects Special C (M) connector (kit) type on Port X. Selects Special C (F) connector (kit) type on Port X.	CMSPC CFSPC P1C?; P2C?
USER DEFINED	Calls menu C21A, C21B, then C21C, which allows you to define the inductance coefficients and offset length values.	
PRESS <ENTER> WHEN COMPLETE	Pressing the Enter key implements your menu selection.	None

*Menu C14, Select Port X Offset Short Connecotr Type*

MENU	DESCRIPTION	GPIB COMMAND
SELECT PORT X OFFSET SHORT	Used with the microstrip line type.	None
SPECIAL A (M) SPECIAL A (F)	Selects Special A (M) connector (kit) type on Port X. Selects Special A (F) connector (kit) type on Port X.	CMSPA CFSPA P1C?; P2C?
SPECIAL B (M) SPECIAL B (F)	Selects Special B (M) connector (kit) type on Port X. Selects Special B (F) connector (kit) type on Port X.	CMSPB CFSPB P1C?; P2C?
SPECIAL C (M) SPECIAL C (F)	Selects Special C (M) connector (kit) type on Port X. Selects Special C (F) connector (kit) type on Port X.	CMSPC CFSPC P1C?; P2C?
USER DEFINED	Calls menus C21A, C21B, then C21C, which allows you to define the inductance coefficients and offset length values.	
PRESS <ENTER> WHEN COMPLETE	Pressing the Enter key implements your menu selection.	None

*Menu C14A, Select Port X Offset Short*

MENU	DESCRIPTION	GPIB COMMAND
SELECT WAVEGUIDE KIT TO USE		None
-INSTALLED KIT-	The lines below indicate the characteristics of the installed waveguide calibration kit, if applicable.	None
IDENTIFIER XXXX	Displays the type of waveguide used.	WGSER?
CUTOFF FREQ: XXX.XXXXXXXXXX GHz	Displays the cutoff frequency of the waveguide.	WGCUTOFF?
SHORT 1 XX.XXXXmm	Displays the offset length of the first calibration short.	WGSHOFF1?
SHORT 2 XX.XXXXmm	Displays the offset length of the second calibration short.	WGSHOFF2?
USE INSTALLED WAVEGUIDE KIT	Move the cursor to this line and press Enter to use the displayed kit.	WK1; WKX?
USER DEFINED	Calls menu C15A, which lets you modify the parameters.	None
PRESS <ENTER> TO SELECT	Pressing the Enter key implements your menu selection.	None

*Menu C15, Select Waveguide Kit to Use*

MENU	DESCRIPTION	GPIB COMMAND
ENTER WAVEGUIDE PARAMETERS		None
WAVEGUIDE CUTOFF FREQ XXX.XXXXXXXXXX GHz	Calls menu C15B that allows you to enter waveguide cutoff frequency.	None
OFFSET LENGTH OF SHORT 1 X.XXXX mm	Move the cursor to this line and enter the offset length of Short 1.	WSH1; WSH1?
OFFSET LENGTH OF SHORT 2 X.XXXX mm	Move the cursor to this line and enter the offset length of Short 2.	WSH2; WSH2?
PRESS <ENTER> WHEN COMPLETE	Pressing the Enter key implements your menu selection.	None

*Menu C15A, Enter Waveguide Parameters*

MENU	DESCRIPTION	GPIB COMMAND
ENTER WAVEGUIDE CUTOFF FREQUENCY		None
WAVEGUIDE CUTOFF FREQ XXX.XXXXXXXXXX GHz	Enter waveguide cutoff frequency.	WCO; WCO?
PRESS <ENTER> WHEN COMPLETE	Pressing the Enter key implements your menu selection.	None

*Menu C15B, Enter Waveguide Parameters*

MENU	DESCRIPTION	GPIB COMMAND
SELECT WAVEGUIDE KIT TO USE	Used for the SSST calibration method.	None
INSTALLED KIT	The lines below indicate the characteristics of the installed waveguide calibration kit, if applicable.	None
IDENTIFIER: XXXXXXXX	Displays the type of waveguide used.	WGSER?
CUTOFF FREQ: XXX.XXXXXXXXXX GHz	Displays the cutoff frequency of the waveguide.	WGCUTOFF?
SHORT 1: +XX.XXXX mm	Displays the offset length of the first calibration short.	WGSHOFF1?
SHORT 2: +XX.XXXX mm	Displays the offset length of the second calibration short.	WGSHOFF2?
SHORT 3: +XX.XXXX mm	Displays the offset length of the third calibration short.	WGSHOFF3?
USE INSTALLED WAVEGUIDE KIT	Move the cursor to this line and press Enter to use the displayed kit.	WK1; WKX?
USER DEFINED	Calls menu C15C, which lets you modify the parameters.	None
PRESS <ENTER> TO SELECT	Pressing the Enter key implements your menu selection.	None

*Menu C15C, Select Waveguide Kit to Use*

MENU	DESCRIPTION	GPIB COMMAND
ENTER WAVEGUIDE PARAMETERS	Used for the SSST calibration method.	None
WAVEGUIDE CUTOFF FREQ XXX.XXXXXXXXXX GHz	Calls menu C15B that allows you to enter waveguide cutoff frequency.	None
OFFSET LENGTH OF SHORT 1 +XXX.XXXX mm	Move the cursor to this line and enter the offset length of Short 1.	WSH1; WSH1?
OFFSET LENGTH OF SHORT 2 +XXX.XXXX mm	Move the cursor to this line and enter the offset length of Short 2.	WSH2; WSH2?
OFFSET LENGTH OF SHORT 3 +XXX.XXXX mm	Move the cursor to this line and enter the offset length of Short 3.	WSH3; WSH3?
PRESS <ENTER> WHEN COMPLETE	Pressing the Enter key implements your menu selection.	None

*Menu C15D, Enter Waveguide Parameters*

MENU	DESCRIPTION	GPIB COMMAND
SELECT MICROSTRIP KIT TO USE		None
10 MIL KIT	Selects parameters for 10 mil UTF kit.	U10; UTFX?
15 MIL KIT	Selects parameters for 15 mil UTF kit.	U15; UTFX?
25 MIL KIT	Selects parameters for 25 mil UTF kit.	U25; UTFX?
USER DEFINED	Calls menu C16A, which lets you modify the parameters.	None
PRESS <ENTER> TO SELECT	Pressing the Enter key implements your menu selection.	None

*Menu C16, Select Microstrip Parameters*

MENU	DESCRIPTION	GPIB COMMAND
ENTER MICROSTRIP PARAMETERS		None
WIDTH OF STRIP XX.XXXX mm	Move the cursor to this line and enter the width of the microstrip you are using.	USW; USW?
THICKNESS OF SUBSTRATE XXXX.XXXX mm	Move the cursor to this line and enter the thickness of the substrate you are using.	SBT; SBT?
Z <sub>c</sub> XXX.XXX Ω	Move the cursor to this line and enter the characteristic impedance of the microstrip.	USZ; USZ?
SUBSTRATE DIELECTRIC XX.XX	Move the cursor to this line and enter the relative dielectric constant of the substrate you are using.	SBD; SBD?
EFFECTIVE DIELECTRIC XX.XX (RECOMMENDED 1.00)	Move the cursor to this line and enter the effective dielectric constant of the microstrip. A recommended value will also be displayed.	USE; USE?
PRESS <ENTER> WHEN COMPLETE	Pressing the Enter key implements your menu selection.	None

*Menu C16A, Enter Microstrip Parameters*

MENU	DESCRIPTION	GPIB COMMAND
ENTER REFERENCE IMPEDANCE		None
REFERENCE IMPEDANCE XXX.XXX $\Omega$	Enter the reference impedance ( $Z_0$ ) of the coaxial reference line standard.	LLZ; LLZ?
PRESS <ENTER> WHEN COMPLETE	Pressing the Enter key implements your menu selection.	None

*Menu C17, Enter Line Impedance*

MENU	DESCRIPTION	GPIB COMMAND
CHANGE LRL/LRM PARAMETERS		None
NEXT CAL STEP	Selects next calibration step. Must move cursor to here after making below selections. Pressing the Enter key then moves you to the next step. Calls menu C18A for one band or C18B for two bands.	None
NUMBER OF BANDS USED		None
ONE BAND	Selects a one-band LRL or LRM calibration.	LR2; LRX?
TWO BANDS	Selects a two-band LRL or LRM calibration (that is, a three-line LRL or concatenated LRL and LRM calibrations).	LR3; LRX?
LOCATION OF REFERENCE PLANES		None
MIDDLE OF LINE 1 (REF)	Select reference planes to be at middle of line 1.	RM1; RMX?
ENDS OF LINE 1 (REF)	Select reference planes to be at end of line 1.	RRP; RMX?
PRESS <ENTER> TO SELECT	Pressing the Enter key implements your menu selection.	None

*Menu C18, Change LRL/LRM Parameters*



MENU	DESCRIPTION	GPIB COMMAND
CHANGE LRL/LRM PARAMETERS		None
NEXT CAL STEP	Selects next calibration step. Must move cursor to here after making below selections. Pressing the Enter key then moves you to the next step. Calls menu C19.	None
CHARACTERIZE CAL DEVICES		None
DEVICE 1 LINE 1 (REF) X.XXXX mm	Enter length of line 1.	LL1; LL1?
DEVICE 2 LINE /MATCH X.XXXX mm/FULLBAND	Select device 2—LINE or MATCH; if line is selected, enter length.	LL2; LM2; LX2?
PRESS <ENTER> TO SELECT OR SWITCH	Press Enter to select. If DEVICE 2 is chosen, pressing the Enter key toggles between LINE and MATCH.	None

*Menu C18A, Change LRL/LRM Parameters*

MENU	DESCRIPTION	GPIB COMMAND
CHANGE LRL/LRM PARAMETERS		None
NEXT CAL STEP	Selects next calibration step. Must move cursor to here after making below selections. Pressing the Enter key then moves you to the next step. Calls menu C19.	None
CHARACTERIZE CAL DEVICES		None
DEVICE 1 LINE 1 (REF) XX.XXXX	Enter length of line 1.	LL1; LL1?
DEVICE 2 LINE/MATCH XX.XXXX/LOWBAND	Press Enter to toggle between LINE and MATCH. If LINE is selected, enter line length. If match is selected, LOWBAND is displayed. This indicates that device 2 is the lowband match.	LL2; LL2?; LM2; LX2?
DEVICE 3 LINE/MATCH XX.XXXX/HIGHBAND	Press Enter to toggle between LINE and MATCH. If LINE is selected, enter line length. If match is selected, HIGHBAND is displayed. This indicates that device 3 is the high band match.	LL3; LL3?; LM3; LX3?
FREQ AFTER WHICH THE USE OF DEVICE 2 AND DEVICE 3 IS EXCHANGED		None
BREAKPOINT XXX.XXXXXXXXXXGHZ	Enter breakpoint frequency: end of band 1, beginning of band 2.	BPF; BPF?
PRESS <ENTER> TO SELECT OR SWITCH	Pressing the Enter key implements your menu selection.	None

*Menu C18B, Change LRL/LRM Parameters—Two Band Calibration*

MENU	DESCRIPTION	GPIB COMMAND
CHANGE LRL/LRM PARAMETERS		None
NEXT CAL STEP	Moves to the next calibration step. Must move cursor to here after making below selections. Pressing the Enter key then moves you to the next step.	None
REFLECTION OFFSET LENGTH +XXX.XXXX mm	Enter the offset length of the reflective device.	None
REFLECTION TYPE		ROL; ROL?
GREATER THAN $Z_0$	Specifies the reflection to have an impedance value greater than the reference impedance ( $Z_0$ ). This is typically an open device.	RGZ; RXZ?
LESS THAN $Z_0$	Selects the reflection to have an impedance value less than the reference impedance ( $Z_0$ ). This is typically a short device.	RLZ; RXZ
MATCH PARAMETERS		
MATCH IMPEDANCE +XXX.XXX $\Omega$	Allows entry of the impedance (defaults to 50.000 $\Omega$ ).	LMZ; LMZ?
MATCH INDUCTANCE +XXXX.XXXX pH	Allows entry of the inductance (defaults to 0.00 e-12).	LMZL; LMZL?
PRESS <ENTER> TO SELECT	Pressing the Enter key implements the selection.	None

*Menu C19, Change LRL/LRM Parameters*

MENU	DESCRIPTION	GPIB COMMAND
ENTER THROUGH LINE PARAMETERS		None
OFFSET LENGTH X.XXXX mm	Enter offset length of through-line device.	TOL; TOL?
THROUGHLINE IMPEDANCE X.XXXX $\Omega$	Enter the impedance of the through-line device.	TLZ; TLZ?
PRESS <ENTER> WHEN COMPLETE	Pressing the Enter key brings the next calibration menu.	None

*Menu C20, Change Through Parameters*

MENU	DESCRIPTION	GPIB COMMAND
PORT X OFFSET SHORT 1		None
ENTER THE INDUCTANCE COEFFICIENTS		
L0 [e-12 H] +XXXX.XXXX	Enter the inductance coefficients of the offset short.	None
L1 [e-24 H/Hz] +XXXX.XXXX	Enter the inductance coefficients of the offset short.	None
L2 [e-33 H/Hz <sup>2</sup> ] +XXXX.XXXX	Enter the inductance coefficients of the offset short.	None
L3 [e-42 H/Hz <sup>3</sup> ] +XXXX.XXXX	Enter the inductance coefficients of the offset short.	None
ENTER THE OFFSET LENGTH		
OFFSET LENGTH +XXX.XXXX mm	Enter the offset length of the offset short.	None
PRESS <ENTER> WHEN COMPLETE	Pressing the Enter key calls menu C21B.	None

*Menu C21A, Port X Offset Short 1*

MENU	DESCRIPTION	GPIB COMMAND
PORT X OFFSET SHORT 2		None
ENTER THE INDUCTANCE COEFFICIENTS		
L0 [e-12 H] +XXXX.XXXX	Enter the inductance coefficients of the offset short.	None
L1 [e-24 H/Hz] +XXXX.XXXX	Enter the inductance coefficients of the offset short.	None
L2 [e-33 H/Hz <sup>2</sup> ] +XXXX.XXXX	Enter the inductance coefficients of the offset short.	None
L3 [e-42 H/Hz <sup>3</sup> ] +XXXX.XXXX	Enter the inductance coefficients of the offset short.	None
ENTER THE OFFSET LENGTH		
OFFSET LENGTH +XXX.XXXX mm	Enter the offset length of the offset short.	None
PRESS <ENTER> WHEN COMPLETE	Pressing the Enter key calls menu C3X, for a SSLT calibration method, or menu C21B, for a SSST calibration method.	None

*Menu C21B, Port X Offset Short 2*

MENU	DESCRIPTION	GPIB COMMAND
PORT X OFFSET SHORT 3		None
ENTER THE INDUCTANCE COEFFICIENTS		
L0 [e-12 H] +XXXX.XXXX	Enter the inductance coefficients of the offset short.	None
L1 [e-24 H/Hz] +XXXX.XXXX	Enter the inductance coefficients of the offset short.	None
L2 [e-33 H/Hz <sup>2</sup> ] +XXXX.XXXX	Enter the inductance coefficients of the offset short.	None
L3 [e-42 H/Hz <sup>3</sup> ] +XXXX.XXXX	Enter the inductance coefficients of the offset short.	None
ENTER THE OFFSET LENGTH		
OFFSET LENGTH +XXX.XXXX mm	Enter the offset length of the offset short.	None
PRESS <ENTER> WHEN COMPLETE	Pressing the Enter key calls menu C3X.	None

*Menu C21C, Port X Offset Short 3*

MENU	DESCRIPTION	GPIB COMMAND
CALIBRATION SEQUENCE COMPLETED		None
PRESS <SAVE/RECALL> TO STORE CAL DATA ON DISK  OR	Pressing the SAVE/RECALL MENU Key displays menu SR, which lets you save your calibration data onto a disk or recall previously saved calibration data from a disk. While this menu provides a convenient point at which to save the calibration data, it is not the only point allowed. You can use the SAVE/RECALL MENU key at any point in the measurement program.	None
PRESS <ENTER> TO PROCEED	Pressing the Enter key implements your menu selection.	None

*Menu Cal\_Completed*



MENU	DESCRIPTION	GPIB COMMAND
APPLY CALIBRATION		None
FULL 12-TERM (S11, S21 S22, S12)	Reflects the type of calibration presently stored in internal memory.	
APPLY ON (OFF) CALIBRATION	Turns calibration on or off.	CON; COF; CON?
TUNE MODE ON (OFF)	For applied Full 12-Term calibration only. When turned off, the ratio of forward to reverse sweeps is set to the normal 1:1. When turned on, you can set the ratio of forward sweeps to reverse sweep from 1:1 to 10,000:1 (below).	None
NO. OF FWD (REV) SWEEPS BETWEEN REV (FWD) SWEEPS XXXXX SWEEPS (XXXXX REMAINING)	Lets you enter a value for the number of forward (or reverse) sweeps. Alternatively, this option displays the number of forward sweep (or reverse) remaining before a reverse sweep will occur.	None
PRESS <APPLY CAL> TO TURN ON/OFF	Press the Apply Cal key to apply the stored calibration.	None
PRESS <ENTER> TO TURN ON/OFF	Press the Enter key to turn selected mode on/off.	None

*Menu Cal\_Applied*

MENU	DESCRIPTION	GPIB COMMAND
DATA ENHANCEMENT		None
AVERAGING XXXX MEAS.	Averages the measured data over time, as follows: 1. The sweep stops at the first frequency point and takes a number of readings, based on the selected number of points. 2. The program averages the readings and writes the average value for that frequency point in the displayed graph. 3. The sweep then advances to the next sequential frequency point and repeats the process.	AVG; AVG?
AVERAGING TYPE		
POINT-BY-POINT	Averages the point-by-point up to the number of averages.	PTAVG; SWAVG?
SWEEP-BY-SWEEP	Averages the sweep-by-sweep up to the number of averages.	SWAVG; SWAVG?
RESET AVG COUNT XXXX SWEEP(S)	Zeroes the counter used for sweep averaging.	RSTAVG
SAMPLERS USED PER SWEEP X SAMPLERS	In the normal mode of operation, three samplers are used per forward or reverse sweep; two test samplers and a reference sampler. This results in both transmission and reflection parameters simultaneously.  When a device such as a filter with a deep reject-band is measured, having both test samplers on reduces the measurement dynamic range. A higher noise floor in the reject band of the filter is observed. Selecting two samplers per sweep turns off one of the test samplers. This eliminates channel interaction and thereby improves the dynamic range.  The drawbacks of using two sampler per sweep are a doubling of measurement time, as two complete one-direction sweeps are needed for both transmission and reflection parameters.	SAMP2; SAMP3; SAMP?
RESUME CAL		
PRESS <ENTER> TO SELECT	Pressing the Enter key implements your menu selection and returns you to the calibration setup or sequence.	None
PRESS <AVG/SMOOTH MENU> TO RESET AVG COUNT		

MENU	DESCRIPTION	GPIB COMMAND
ADAPTER REMOVAL		None
12-TERM CALS FOR X AND Y MUST EXIST IN THE CURRENT DIRECTORY		None
ELECTRICAL LENGTH OF THE ADAPTER +XXX.XXXX ps	Displays the electrical length of the adapter. The value of the electrical length is used when the two calibrations are merged. It has the same range as the time delay for reference plane extension and a default value of 0.0000 ps.	ADPL; ADPL?
REMOVE ADAPTER	Calls menu CAR2, which leads you through the reading of the Y'-Y and X-X' calibration files and the computation of the new 12-term error coefficients.	None
HELP	Calls menu EXT_CAR, which provides help text for using this feature.	None
PRESS <ENTER> TO SELECT	Pressing the Enter key implements the selection.	None

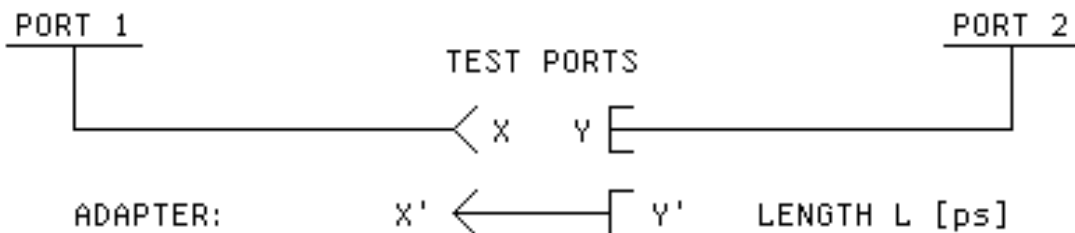
*Menu CAR1, Adapter Removal 1*

MENU	DESCRIPTION	GPIB COMMAND
ADAPTER REMOVAL		None
READ CAL FILE OF X TEST PORT FROM HARD DISK (ADAPTER ON PORT 2)	Calls menu DSK2, which provides instructions.	None
READ CAL FILE OF X TEST PORT FROM FLOPPY DISK (ADAPTER ON PORT 2)	Calls menu DSK2, which provides instructions.	None
PRESS <ENTER> TO SELECT	Pressing the Enter key implements the selection.	None
PRESS <CLEAR> TO ABORT	Pressing the Clear key aborts the selection.	None

*Menu CAR2, Adapter Removal 2*

## - ADAPTER REMOVAL -

THE ADAPTER REMOVAL APPLICATION PERMITS THE USER TO ACCURATELY MEASURE NON-INSERTABLE DEVICES. THE PROCESS INVOLVES USING AN ADAPTER OF KNOWN ELECTRICAL LENGTH AND PERFORMING TWO FULL 12-TERM CALIBRATIONS.



X AND Y ARE COAXIAL OR WAVEGUIDE CONNECTOR TYPES.  
L IS THE LENGTH OF THE ADAPTER [ps].

## - INSTRUCTIONS -

1. CONNECT ADAPTER TO PORT 1. PERFORM A FULL 12-TERM CALIBRATION USING Y' AND Y AS THE TEST PORTS AND STORE CALIBRATION TO DISK (e.g. YPRIME\_Y.CAL).
2. CONNECT ADAPTER TO PORT 2. PERFORM A FULL 12-TERM CALIBRATION USING X AND X' AS THE TEST PORTS AND STORE CALIBRATION TO DISK (e.g. X\_XPRIME.CAL).
3. BOTH X AND Y CAL FILES MUST BE PLACED IN THE CURRENT DIRECTORY OF THE HARD OR FLOPPY DISK.
4. ENTER THE ELECTRICAL LENGTH OF THE ADAPTER.
5. SELECT <REMOVE ADAPTER> TO READ THE X AND Y CAL FILES AND CALCULATE THE NEW SET OF 12-TERM ERROR COEFFICIENTS. IF DESIRED, SAVE RESULTS.

Menu EXT\_CAR, Adapter Removal Help Menu

MENU	DESCRIPTION	GPIB COMMAND
ADAPTER REMOVAL		None
READ CAL FILE OF THE Y TEST PORT FROM HARD DISK (ADAPTER ON PORT 1)	Calls menu DSK2, which provides instructions.	None
READ CAL FILE OF THE Y TEST PORT FROM FLOPPY DISK (ADAPTER ON PORT 1)	Calls menu DSK2, which provides instructions.	None
PRESS <ENTER> TO SELECT	Pressing the Enter key implements the selection.	None
PRESS <CLEAR> TO ABORT	Pressing the Clear key aborts the selection.	None

*Menu CAR3, Adapter Removal 3*

MENU	DESCRIPTION	GPIB COMMAND
ADAPTER REMOVAL		None
COMPUTING NEW 12-TERM ERROR COEFFICIENTS	Information text.	None

*Menu CAR4, Adapter Removal 4*

MENU	DESCRIPTION	GPIB COMMAND
SELECT DISPLAY MODE		None
SINGLE CHANNEL	Selects a single channel for display. You select the type of display in menu GT1 or GT2.	DSP; DSP?
DUAL CHANNELS 1 & 3	Selects Channels 1 and 3 for display. You select the type of display in menu GT1 or GT2.	D13
OVERLAY DUAL CHANNELS 1 & 3	Lets you simultaneously view the Channel 1 data superimposed over the Channel 3 data on a single display. Channel 1 trace displays in red and Channel 3 in yellow.	T13
DUAL CHANNELS 2 & 4	Selects Channels 2 and 4 for display. You select the type of display in menu GT1 or GT2.	D24
OVERLAY DUAL CHANNELS 2 & 4	Lets you simultaneously view the Channel 2 data superimposed over the Channel 4 data on a single display. Channel 2 trace displays in red and Channel 4 in yellow.	T24
ALL FOUR CHANNELS	Selects all four channels for display. You select the type of display in menu GT1 or GT2.	D14
PRESS <ENTER> TO SELECT	Pressing the Enter key implements your menu selection. The menu remains on the screen until another menu is selected for display or until the CLEAR/RET LOC key is pressed.	None

*Menu CM, Select Display Mode*

MENU	DESCRIPTION	GPIB COMMAND
E/O MEASUREMENT		None
MEASURE E/O DUT (MODULATOR)	This menu selection calls menu DE3, then DE3A.	IODF or LDODF
DE-EMBED TRANSFER FUNCTION OF A GENERIC NETWORK	This menu selection calls menu DE4, then DE4A.	IODF or LDODF
PRESS <ENTER> TO SELECT	Pressing the Enter key implements your menu selection.	None

*Menu DE1, E/O Measurement*

- E/O MEASUREMENT -

E/O MEASUREMENTS CAN BE REALIZED BY DE-EMBEDDING THE CHARACTERISTICS OF A TRANSFER STANDARD (DETECTOR STD). SIMILARLY, THE FORWARD TRANSFER FUNCTION OF A GENERIC NETWORK CAN BE DE-EMBEDDED.

- REQUIREMENTS -

- PERFORM AN RF CALIBRATION WITH FORWARD TRANSMISSION CORRECTION - EITHER FULL 12-TERM, 1-PATH 2-PORT FWD, OR FREQUENCY RESPONSE (FWD OR BOTH). STORE THE CAL AND FRONT PANEL SETUP TO DISK (e.g. ORIG-E-E.CAL).
- THE CHARACTERIZATION OF THE DEVICE TO DE-EMBED SHOULD BE IN A FILE USING THE S2P FORMAT (e.g. O-E-DET.S2P). USE AS MANY POINTS AS POSSIBLE TO IMPROVE INTERPOLATION ACCURACY.
- CAL FILES AND S2P CHARACTERIZATION FILES MUST BE PLACED IN THE CURRENT DIRECTORY OF THE DISK.

- INSTRUCTIONS -

1. TO MEASURE E/O DEVICES (e.g. MODULATORS), DE-EMBED THE DETECTOR TRANSFER STANDARD (e.g. O-E-DET.S2P FROM ORIG-E-E.CAL). IF DESIRED, SAVE RESULTS.
2. TO DE-EMBED THE FORWARD TRANSFER FUNCTION OF A GENERIC NETWORK, SELECT A CAL FILE AND AN S2P FILE.

*Menu EXT\_DE1, E/O Measurement*

MENU	DESCRIPTION	GPIB COMMAND
O/E MEASUREMENT		None
DE-EMBED O/E S2P (DETECTOR STD)	This menu selection calls menu DE5, then DE5A.	IODF or LDODF
GENERATE E/O S2P CHARACTERIZATION (MODULATOR)	This menu selection calls menu DE6.	None
MEASURE O/E DUT (DETECTOR)	This menu selection calls menu DE7, then DE7A.	IODF or LDODF
PRESS <ENTER> TO SELECT	Pressing the Enter key implements your menu selection.	None

*Menu DE2, O/E Measurement*

<p>- O/E MEASUREMENT -</p> <p>O/E MEASUREMENTS CAN BE REALIZED BY DE-EMBEDDING THE CHARACTERISTICS OF A TRANSFER STANDARD (MODULATOR STD).</p> <p>- REQUIREMENTS -</p> <ul style="list-style-type: none"> <li>- PERFORM AN RF CALIBRATION WITH FORWARD TRANSMISSION CORRECTION - EITHER FULL 12-TERM, 1-PATH 2-PORT FWD, OR FREQUENCY RESPONSE (FWD OR BOTH). STORE THE CAL AND FRONT PANEL SETUP TO DISK (e.g. ORIG_E-E.CAL).</li> <li>- THE CHARACTERIZATION OF THE DEVICE TO DE-EMBED SHOULD BE IN A FILE USING THE S2P FORMAT (e.g. O-E-DET.S2P AND E-O-MOD.S2P). USE AS MANY POINTS AS POSSIBLE TO IMPROVE INTERPOLATION ACCURACY.</li> <li>- CAL FILES AND S2P CHARACTERIZATION FILES MUST BE PLACED IN THE CURRENT DIRECTORY OF THE DISK.</li> </ul> <p>- INSTRUCTIONS -</p> <ol style="list-style-type: none"> <li>1. DE-EMBED A DETECTOR STANDARD (e.g. O-E-DET.S2P FROM ORIG_E-E.CAL). IF DESIRED, SAVE RESULTS.</li> <li>2. MEASURE THE INTENDED MODULATOR TRANSFER STANDARD AND CAPTURE ITS CHARACTERIZATION BY GENERATING AN S2P FILE (e.g. E-O-MOD.S2P). THIS IS THE SAME AS USING THE S2P DISK FILE HARDCOPY FEATURE.</li> <li>3. TO MEASURE O/E DEVICES (e.g. DETECTORS), DE-EMBED THE MODULATOR TRANSFER STANDARD (e.g. E-O-MOD.S2P FROM ORIG_E-E.CAL). IF DESIRED, SAVE RESULTS.</li> </ol>
---

*Menu EXT\_DE2, O/E Measurement*



MENU	DESCRIPTION	GPIB COMMAND
E/O MEASUREMENT		None
ORIGINAL CAL FILE WITH FWD TRANS CORRECTION		
READ CAL FILE FROM HARD DISK	This menu selection calls menu DSK2 for *.CAL files on the hard disk drive.	None
READ CAL FILE FROM FLOPPY DISK	This menu selection calls menu DSK2 for *.CAL files on the floppy disk drive.	None
PRESS <ENTER> TO SELECT	Pressing the Enter key implements your menu selection.	None
PRESS <CLEAR> TO ABORT	Pressing the Clear key aborts your this menu selection and calls menu DE1.	None

*Menu DE3, E/O Measurement*

MENU	DESCRIPTION	GPIB COMMAND
E/O MEASUREMENT		None
TRANSFER STANDARD TO BE DE-EMBEDED (DETECTOR STD)		
READ S2P FILE FROM HARD DISK	This menu selection calls menu DSK2 for *.S2P files on the hard disk drive.	None
READ S2P FILE FROM FLOPPY DISK	This menu selection calls menu DSK2 for *.S2P files on the floppy disk drive.	None
PRESS <ENTER> TO SELECT	Pressing the Enter key implements your menu selection.	None
PRESS <CLEAR> TO ABORT	Pressing the Clear key aborts this menu selection and calls menu DE1.	None

*Menu DE3A, E/O Measurement*

MENU	DESCRIPTION	GPIB COMMAND
DE-EMBED NETWORK		None
ORIGINAL CAL FILE WITH FWD TRANS CORRECTION		
READ CAL FILE FROM HARD DISK	This menu selection calls menu DSK2 for *.CAL files on the hard disk drive.	None
READ CAL FILE FROM FLOPPY DISK	This menu selection calls menu DSK2 for *.CAL files on the floppy disk drive.	None
PRESS <ENTER> TO SELECT	Pressing the Enter key implements your menu selection.	None
PRESS <CLEAR> TO ABORT	Pressing the Clear key aborts this menu selection and calls menu DE1.	None

*Menu DE4, De-embed Network*

MENU	DESCRIPTION	GPIB COMMAND
DE-EMBED NETWORK		None
TRANSFER FUNCTION TO BE DE-EMBEDED (GENERIC NETWORK)		
READ S2P FILE FROM HARD DISK	This menu selection calls menu DSK2 for *.S2P files on the hard disk drive.	None
READ S2P FILE FROM FLOPPY DISK	This menu selection calls menu DSK2 for *.S2P files on the floppy disk drive.	None
PRESS <ENTER> TO SELECT	Pressing the Enter key implements your menu selection.	None
PRESS <CLEAR> TO ABORT	Pressing the Clear key aborts this menu selection and calls menu DE1.	None

*Menu DE4A, De-embed Network*

MENU	DESCRIPTION	GPIB COMMAND
DE-EMBED O/E S2P		None
ORIGINAL CAL FILE WITH FWD TRANS CORRECTION		
READ CAL FILE FROM HARD DISK	This menu selection calls menu DSK2 for *.CAL files on the hard disk drive.	None
READ CAL FILE FROM FLOPPY DISK	This menu selection calls menu DSK2 for *.CAL files on the floppy disk drive.	None
PRESS <ENTER> TO SELECT	Pressing the Enter key implements your menu selection.	None
PRESS <CLEAR> TO ABORT	Pressing the Clear key aborts this menu selection and calls menu DE2.	None

*Menu DE5, De-embed O/E S2P*

MENU	DESCRIPTION	GPIB COMMAND
DE-EMBED O/E S2P		None
TRANSFER STANDARD TO BE DE-EMBEDED (DETECTOR STANDARD)		
READ S2P FILE FROM HARD DISK	This menu selection calls menu DSK2 for *.S2P files on the hard disk drive.	None
READ S2P FILE FROM FLOPPY DISK	This menu selection calls menu DSK2 for *.S2P files on the floppy disk drive.	None
PRESS <ENTER> TO SELECT	Pressing the Enter key implements your menu selection.	None
PRESS <CLEAR> TO ABORT	Pressing the Clear key aborts this menu selection and calls menu DE2.	None

*Menu DE5A, De-embed O/E S2P*

MENU	DESCRIPTION	GPIB COMMAND
GENERATE E/O S2P CHARACTERIZATION		None
CONNECT TRANSFER STANDARD DETECTOR AND DE-EMBED ITS CHARACTERIZATION		
CONNECT E/O DEVICE (MODULATOR) AND APPLY BIAS		
INCLUDE ANY OTHER COMPONENTS WHICH ARE PART OF THE MEASUREMENT PATH		
WAIT FOR A COMPLETE SWEEP BEFORE STORING		
SAVE S2P DATA TO HARD DISK	This menu selection calls menu DSK3 for *.S2P files on the hard disk drive.	SAVE
SAVE S2P DATA TO FLOPPY DISK	This menu selection calls menu DSK3 for *.S2P files on the floppy disk drive.	SAVE
PRESS <ENTER> TO SELECT	Pressing the Enter key implements your menu selection.	None
PRESS <CLEAR> TO ABORT	Pressing the Clear key aborts this menu selection and calls menu DE2.	None

*Menu DE6, Generate E/O S2P Characterization*

MENU	DESCRIPTION	GPIB COMMAND
O/E MEASUREMENT		None
ORIGINAL CAL FILE WITH FWD TRANS CORRECTION		
READ CAL FILE FROM HARD DISK	This menu selection calls menu DSK2 for *.CAL files on the hard disk drive.	None
READ CAL FILE FROM FLOPPY DISK	This menu selection calls menu DSK2 for *.CAL files on the floppy disk drive.	None
PRESS <ENTER> TO SELECT	Pressing the Enter key implements your menu selection.	None
PRESS <CLEAR> TO ABORT	Pressing the Clear key aborts this menu selection and calls menu DE2.	None

*Menu DE7, O/E Measurement*

MENU	DESCRIPTION	GPIB COMMAND
O/E MEASUREMENT		None
TRANSFER STANDARD TO BE DE-EMBEDED (MODULATOR)		
READ S2P FILE FROM HARD DISK	This menu selection calls menu DSK2 for *.S2P files on the hard disk drive.	None
READ S2P FILE FROM FLOPPY DISK	This menu selection calls menu DSK2 for *.S2P files on the floppy disk drive.	None
PRESS <ENTER> TO SELECT	Pressing the Enter key implements your menu selection.	None
PRESS <CLEAR> TO ABORT	Pressing the Clear key aborts this menu selection and calls menu DE2.	None

*Menu DE7A, O/E Measurement*

MENU	DESCRIPTION	GPIB COMMAND
EMBED/DE-EMBED S2P FILE	<p>Users can perform any type of calibration. Normally, embedding/de-embedding is applied to a 12-term calibration. However, users can apply lesser types of embedding/de-embedding depending on the calibration type: 1-path 2-port (forward, reverse) . reflection only (port 1, port 2, both ports), and frequency response (forward, reverse, both)</p> <p>Circular interpolation is used. If the calibration has a frequency range beyond the S2P file data frequency range, then either the first or last S2P data are used – 'flat' extrapolation. The user is warned that this extension of the S2P data has occurred.</p> <p>Diabolical configurations will also be detected. For instance, attaching a network to a port not supported in a calibration, corrupt cal file, corrupt s2p data, no calibration in cal file, and other messages may have to be displayed.</p>	None
PORT 1/PORT 2	Selects between Port 1 or Port 2; Port 1 is the default setting.	EDEPORT1; EDEPORT2; EDEPORT?
METHOD EMBED/DE-EMBED	Selects the method to be used. De-embed is the default setting.	EDED; EDEE; EDENORM EDEED?
SWAP PORTS OFF (ON) OF S2P DATA	Lets users choose to swap ports for the S2P data. OFF is the default setting.	EDESWAP; EDESWAP?
APPLY NETWORK S2P FILE DATA TO CAL FILE DATA	Calls menus DE9 then DE9A. These menus let users read CAL data or S2P data to the hard disk or the floppy disk.	IEDEF; LDEDEF
PRESS <ENTER> TO SELECT OR CHANGE	Press the ENTER key to implement the menu selection.	None

*Menu DE8, Embed/De-embed S2P File*

- EMBEDDING & DE-EMBEDDING S2P FILES -

THE CALIBRATED ERROR REFERENCE PLANE(S) CAN BE MOVED TO A DIFFERENT POSITION BY EITHER MATHEMATICALLY ADDING (EMBEDDING) OR REMOVING (DE-EMBEDDING) A NETWORK (S2P FILE) TO OR FROM A CALIBRATION (CAL FILE).

- REQUIREMENTS -

- .PERFORM AN RF CALIBRATION, ANY TYPE. STORE THE CAL AND FRONT PANEL SETUP TO DISK (e.g. ORIGINAL.CAL).
- .THE CHARACTERIZATION OF THE NETWORK TO EMBED/DE-EMBED SHOULD BE IN A FILE USING THE S2P FORMAT (e.g. NETWORK.S2P). USE AS MANY POINTS AS POSSIBLE TO IMPROVE INTERPOLATION ACCURACY. MAKE SURE ITS FREQ RANGE INCLUDES THE FREQ RANGE OF THE CAL FILE.
- CAL FILES AND S2P CHARACTERIZATION FILES MUST BE PLACED IN THE CURRENT DIRECTORY OF THE DISK.
- 

.INSTRUCTIONS .

1. SELECT PORT AND METHOD. EMBEDDING MATHEMATICALLY ADDS (e.g. MATCHING NETWORK) TO THE SELECTED PORT. DR-EMBEDDING MATHEMATICALLY REMOVES (e.g. TEST FIXTURE) FROM THE SELECTED PORT.
2. SWAPPING THE PORTS OF THE S2P DATA EXCHANGES THE S11 S22 AND S21 S12 WHILE APPLYING.
3. TO EMBED/DE-EMBED THE NETWORK, APPLY A NETWORK S2P FILE TO A CAL FILE. IF DESIRED, SAVE RESULTS.

*Menu EXT\_DE8, Embed/De-embed S2P File*

MENU	DESCRIPTION	GPIB COMMAND
EMBED/DE-EMBED S2P FILE		None
ORIGINAL CAL FILE TO APPLY NETWORK	Lets users select a cal file from the hard or floppy disks.	None
READ CAL FILE FROM HARD DISK	Calls menu DSK2, which lets users select a file from the hard disk.	None
READ CAL FILE FROM FLOPPY DISK	Calls menu DSK2, which lets users select a file from the floppy disk.	None
PRESS <ENTER> TO SELECT	Press the ENTER key to implement the menu selection.	None
PRESS <CLEAR> TO ABORT	Press the CLEAR key to abprt the menu selection.	None

*Menu DE9, Embed/De-embed S2P File*



MENU	DESCRIPTION	GPIB COMMAND
EMBED/DE-EMBED S2P FILE		None
S2P FILE DATA OF THE NETWORK	Lets users select an S2P file from the hard or floppy disks.	None
READ S2P FILE FROM HARD DISK	Calls menu DSK2, which lets users select a file from the hard disk.	None
READ S2P FILE FROM FLOPPY DISK	Calls menu DSK2, which lets users select a file from the floppy disk.	None
PRESS <ENTER> TO SELECT	Press the ENTER key to implement the menu selection.	None
PRESS <CLEAR> TO ABORT	Press the CLEAR key to abprt the menu selection.	None

*Menu DE9A, Embed/De-embed S2P File*

MENU	DESCRIPTION	GPIB COMMAND
DISCRETE FILL		None
INPUT START, INCR, POINTS, THEN SELECT "FILL RANGE"	This menu is used to create one or more ranges of discrete equally spaced frequency points.	None
START FREQ XXX.XXXXXXXXXX GHz	Enter the first frequency of the range.	None
INCREMENT XXX.XXXXXXXXXX GHz	Enter the increment (step size) between one frequency and the next.	None
NUMBER OF PTS XXXX POINT(S)	Enter the number of frequency points in the range.	None
STOP FREQ XXX.XXXXXXXXXX GHz	Enter the stop frequency, in GHz.	None
FILL RANGE ( XXXX ENTERED)	Moving the cursor here and pressing Enter fills the range and shows the number of frequencies selected (in NUM OF PTS above).	None
INDIVIDUAL FREQ INSERT	Calls menu DF2, which allows you to set the individual frequencies.	None
CLEAR ALL	Clears all entries displayed above.	None
FINISHED RETURN TO SWP	Closes this menu.	None
PRESS <ENTER> TO SELECT	Pressing the Enter key implements your menu selection.	None

*Menu DF1, Discrete Fill*

MENU	DESCRIPTION	GPIB COMMAND
INSERT INDIVIDUAL FREQUENCIES		None
INPUT A FREQ, PRESS <ENTER> TO INSERT	Enter the start frequency, increment frequency, and number of points; then select the FILL RANGE menu option, below.	None
NEXT FREQ XXX.XXXXXXXXXX GHz	Enter the sweep start frequency, in GHz.	None
XXXX FREQS ENTERED LAST FREQ WAS XXX.XXXXXXXXXX GHz	Enter the frequency, in GHz, by which you want to increment the start frequency.	None
AUTO INCR ON (OFF) XXX.XXXXXXXXXX GHz	Enter the number of points.	None
PREVIOUS MENU	Returns to the previous menu.	None
PRESS <ENTER> THEN SELECT OR TURN ON/OFF	Press the Enter key to implements your menu selection or to turn a selection on or off.	None

*Menu DF2, Insert Individual Frequencies*

MENU	DESCRIPTION	GPIB COMMAND
WARNING		None
DEFAULT PROGRAM SELECTED		
CONTINUING WILL ERASE CURRENT SETUP AND CALIBRATION		
PRESS <DEFAULT PRGM> TO CONFIRM	Pressing the DEFAULT PROGRAM key a second time resets the 360 VNA to its default settings. Press the DEFAULT PROGRAM key, the "0" key, then the DEFAULT PROGRAM key again clears all internal memories. This keying method can be used to clear memories of data used for classified operations.	
OR		
PRESS <CLEAR> TO ABORT	Pressing the CLEAR key implements your menu selection.	

*Menu DFLT, Default Program Selected*

MENU	DESCRIPTION	GPIB COMMAND
DIAGNOSTICS		None
START SELF TEST	Starts a self test of the 37XXXD.	TST; *TST?
INSTALLED OPTIONS	Displays the fitted options.	*OPT?
PERIPHERAL TESTS	Calls menu DG3, which provides tests for peripherals such as the LCD, front panel, external keyboard, printer and GPIB interfaces.	None
SERVICE FUNCTIONS		
READ SERVICE LOG (FOR SERVICE USE ONLY)	Calls menu DG2, which gives you options for using the Service Log.	None
TROUBLESHOOTING (FOR SERVICE USE ONLY)	Calls menu DG4, which provides options for troubleshooting the 37XXXD hardware. This menu is intended for use by a qualified service technician. Refer to the Model 37XXXD Maintenance Manual for additional information.	None
H/W CALIBRATIONS (FOR SERVICE USE ONLY)	Calls menu DG5, which provides for invoking calibration routines for use by a qualified service technician. Refer to the Model 37XXXD Maintenance Manual for additional information.	None
AUTOCAL ASSURANCE	Calls Menu ACAL_ASSUR, which provides for performing AutoCal assurance routines.	None
PRESS <ENTER> TO SELECT	Pressing the Enter key implements your menu selection.	None

*Menu DG1, Diagnostics 1*

MENU	DESCRIPTION	GPIB COMMAND
WARNING		None
DEFAULT PROGRAM SELECTED		
CONTINUING WILL ERASE CURRENT SETUP AND CALIBRATION		
PRESS <DEFAULT PROGRAM> TO CONFIRM	Pressing the DEFAULT PROGRAM key a second time resets the VNA to its default settings. Press the DEFAULT PROGRAM key, the "0" key, then the DEFAULT PROGRAM key again clears all internal memories. This keying method can be used to clear memories of data used for classified operations.	
PRESS <CLEAR> TO ABORT	Pressing the CLEAR key implements your menu selection.	

*Menu DG2, Troubleshooting*

MENU	DESCRIPTION	GPIB COMMAND
PERIPHERAL TESTS		None
DISPLAY	Provides a graphic display for evaluating screen colors and linearity.	
FRONT PANEL	Provides for testing the front panel keys.	
EXTERNAL KEYBOARD	Provides for testing the external keyboard connected to the Keyboard connector on the front panel.	
PRINTER INTERFACE	Provides for testing the printer interface.	
GPIB INTERFACE	Provides for testing the GPIB interface.	
PREVIOUS MENU	Returns to menu DG1.	None
PRESS <ENTER> TO SELECT	Pressing the Enter key implements your menu selection.	None

*Menu DG3, Diagnostics 3*

MENU	DESCRIPTION	GPIB COMMAND
FLOPPY DISK UTILITIES		None
DISPLAY DIRECTORY	Directory displays in the screen's data area. Press <1> for previous page, <2> for next page, <0> for first page, and <3> for last page.	DIR
DELETE FILES	Calls DSK6, which lets you delete data files.	None
COPY FILES TO HARD DISK	Calls DSK8, which lets you copy files to the hard disk.	None
FORMAT FLOPPY DISK	Formats the floppy disk.	INT
COMMAND LINE	Prompts a one-line dialog box that allows you to enter a command. The dialog box remains open only for the user interface.	None
HARD DISK UTILITIES	Calls DSK1-HD, which provides hard disk utilities.	None
PRESS <ENTER> TO SELECT	Pressing Enter implements your menu selection. You will be returned to the previous menu when your selection is made.	None

*Menu DSK\_FD, Floppy Disk Utilities*

MENU	DESCRIPTION	GPIB COMMAND
HARD DISK UTILITIES		None
DISPLAY DIRECTORY	Directory displays in the screen's data area. Press <1> for previous page, <2> for next page, <0> for first page, and <3> for last page.	DIR
DELETE FILES	Calls DSK6, which lets you delete data files.	None
COPY FILES TO FLOPPY DISK	Calls DSK8, which lets you copy files to the floppy disk.	None
FORMAT HARD DISK	Formats the hard disk.	None
COMMAND LINE	Prompts a one-line dialog box that allows you to enter a command. The dialog box remains open only for the user interface.	None
FLOPPY DISK UTILITIES	Calls DSK1-FD, which provides floppy disk utilities.	None
PRESS <ENTER> TO SELECT	Pressing the Enter key implements your menu selection.	None

*Menu DSK\_HD, Hard Disk Utilities*



MENU	DESCRIPTION	GPIB COMMAND
SELECT FILE TO READ		None
FILE 1	Displays the data stored in file number 1.	
FILE 2	Displays the data stored in file number 2.	
FILE 3	Displays the data stored in file number 3.	
FILE 4	Displays the data stored in file number 4.	
FILE 5	Displays the data stored in file number 5.	
FILE 6	Displays the data stored in file number 6.	
FILE 7	Displays the data stored in file number 7.	
FILE 8	Displays the data stored in file number 8.	
PREVIOUS MENU	Returns to the previous menu.	None
PRESS <ENTER> TO SELECT	Pressing the Enter key implements your menu selection.	None
PRESS <1> FOR PREVIOUS PAGE	Pressing the "1" key on the keypad returns to the previous page.	
PRESS <2> FOR NEXT PAGE	Pressing the "2" key on the keypad produces the next page.	None

*Menu DSK2, Select File to Read*

MENU	DESCRIPTION	GPIB COMMAND
SELECT FILE TO OVERWRITE		None
CREATE NEW FILE		
FILE 1	Select file number 1 to be overwritten with new data.	
FILE 2	Select file number 2 to be overwritten with new data.	
FILE 3	Select file number 3 to be overwritten with new data.	
FILE 4	Select file number 4 to be overwritten with new data.	
FILE 5	Select file number 5 to be overwritten with new data.	
FILE 6	Select file number 6 to be overwritten with new data.	
FILE 7	Select file number 7 to be overwritten with new data.	
FILE 8	Select file number 8 to be overwritten with new data.	
PREVIOUS MENU	Returns to the previous menu.	None
PRESS <ENTER> TO SELECT	Pressing the Enter key implements your menu selection.	None
PRESS <1> FOR PREVIOUS PAGE	Pressing the "1" key on the keypad returns to the previous page.	
PRESS <2> FOR NEXT PAGE	Pressing the "2" key on the keypad produces the next page.	None

*Menu DSK3, Select File to Overwrite*

MENU	DESCRIPTION	GPIB COMMAND
TYPE OF FILES TO DELETE		None
FRONT PANEL SETUP AND CAL DATA	Calls menu DSK7, which provides a list of front panel and calibration data file.	None
TRACE DATA	Calls menu DSK7, which provides a list of trace data files to delete.	None
TABULAR DATA	Calls menu DSK7, which provides a list of tabular data files to delete.	None
TEXT DATA	Calls menu DSK7, which provides a list of text files to delete.	None
S2P DATA	Calls menu DSK7, which provides a list of S2P data files to delete.	None
BITMAP DATA	Calls menu DSK7, which provides a list of bitmap files to delete.	None
HPGL DATA	Calls menu DSK7, which provides a list of HPGL files to delete.	None
ALL TYPES (*.*)	Calls menu DSK7, which provides a list of all file types.	None
PREVIOUS MENU	Returns to the previous menu.	None
PRESS <ENTER> TO SELECT	Pressing the Enter key implements your menu selection.	None

*Menu DSK6, Type of Files to Delete*

MENU	DESCRIPTION	GPIB COMMAND
SELECT FILE TO DELETE		None
FILE 1	Selects file number 1 data to be deleted.	
FILE 2	Selects file number 2 data to be deleted.	
FILE 3	Selects file number 3 data to be deleted.	
FILE 4	Selects file number 4 data to be deleted.	
FILE 5	Selects file number 5 data to be deleted.	
FILE 6	Selects file number 6 data to be deleted.	
FILE 7	Selects file number 7 data to be deleted.	
FILE 8	Selects file number 8 data to be deleted.	
PREVIOUS MENU	Returns to the previous menu.	None
PRESS <ENTER> TO SELECT	Pressing the Enter key implements your menu selection.	None
PRESS <1> FOR PREVIOUS PAGE	Pressing the "1" key on the keypad returns to the previous page.	
PRESS <2> FOR NEXT PAGE	Pressing the "2" key on the keypad produces the next page.	None

*Menu DSK7, Select File to Delete*

MENU	DESCRIPTION	GPIB COMMAND
TYPE OF FILES TO COPY		None
FRONT PANEL SETUP AND CAL DATA	Calls menu DSK9, which provides a list of front panel and calibration data file.	None
TRACE DATA	Calls menu DSK9, which provides a list of trace data files to copy.	None
TABULAR DATA	Calls menu DSK9, which provides a list of tabular data files to copy.	None
TEXT DATA	Calls menu DSK9, which provides a list of text files to copy.	None
S2P DATA	Calls menu DSK9, which provides a list of S2P files to copy.	None
BITMAP DATA	Calls menu DSK9, which provides a list of bitmap files to copy.	None
HPGL DATA	Calls menu DSK9, which provides a list of HPGL files to copy.	None
ALL TYPES (*.*)	Calls menu DSK9, which provides a list of all file types.	None
PREVIOUS MENU	Returns to the previous menu.	None
PRESS <ENTER> TO SELECT	Pressing the Enter key implements your menu selection.	None

*Menu DSK8, Type of Files to Copy*

MENU	DESCRIPTION	GPIB COMMAND
SELECT FILE TO COPY		None
FILE 1	Selects file number 1 data to be copied.	COPY
FILE 2	Selects file number 2 data to be copied.	COPY
FILE 3	Selects file number 3 data to be copied.	COPY
FILE 4	Selects file number 4 data to be copied.	COPY
FILE 5	Selects file number 5 data to be copied.	COPY
FILE 6	Selects file number 6 data to be copied.	COPY
FILE 7	Selects file number 7 data to be copied.	COPY
FILE 8	Selects file number 8 data to be copied.	COPY
PREVIOUS MENU	Returns to the previous menu.	None
PRESS <ENTER> TO SELECT	Pressing the Enter key implements your menu selection.	None
PRESS <1> FOR PREVIOUS PAGE	Pressing the "1" key on the keypad returns to the previous page.	
PRESS <2> FOR NEXT PAGE	Pressing the "2" key on the keypad produces the next page.	None

*Menu DSK9, Select File to Copy*

MENU	DESCRIPTION	GPIB COMMAND
CAPTURE TABULAR DATA	Captures the tabular data to a file when the Enter key is pressed.	None
PRESS <ENTER> TO CONTINUE	Pressing the Enter key implements your menu selection.	None

*Menu DSK10, Capture Tabular Data*

MENU	DESCRIPTION	GPIB COMMAND
CAUTION: ALL FLOPPY DISK DATA WILL BE ERASED		None
INSERT DISK TO FORMAT	Ensure that you have the correct floppy diskette for formatting, then press the Enter key to begin the formatting process.	None
PRESS <ENTER> TO CONTINUE	Pressing the Enter key implements your menu selection.	None

*Menu DSK11, Format Floppy Disk*

MENU	DESCRIPTION	GPIB COMMAND
CAUTION: ALL HARD DISK DATA WILL BE ERASED		None
ASSUME HARD DISK READY TO FORMAT	Assumes that the hard disk is ready to be formatted; press the Enter key to begin the formatting process.	None
PRESS <ENTER> TO CONTINUE	Pressing the Enter key implements your menu selection.	None

*Menu DSK12, Format Hard Disk*

MENU	DESCRIPTION	GPIB COMMAND
DATA ENHANCEMENT		None
AVERAGING XXXX MEAS.	Averages the measured data over time, as follows: 1. The sweep stops at the first frequency point and takes a number of readings, based on the selected number of points. 2. The program averages the readings and writes the average value for that frequency point in the displayed graph. 3. The sweep then advances to the next sequential frequency point and repeats the process.	AVG; AVG?
AVERAGING TYPE		
POINT-BY-POINT	Averages the point-by-point up to the number of averages.	PTAVG; SWAVG?
SWEEP-BY-SWEEP	Averages the sweep-by-sweep up to the number of sweeps.	SWAVG; SWAVG?
RESET AVG COUNT XXXX SWEEP(S)	Zeros the counter used for sweep averaging	RSTAVG
SMOOTHING XX.XX PERCENT OF SWEEP XXX POINT(S)	Smooths the measured data over frequency, as follows: 1. The program divides the overall sweep into smaller segments, based on the selected percent-of-span. (Refer to Section 4-4 and Figure 4-23 for a description and example of smoothing.) 2. It takes a data reading at each frequency point within that percent-of-span segment. 3. It averages the readings with a raised Hamming window and writes that magnitude value at the mid-frequency point of the segment in the displayed graph or Smith chart. 4. It then advances the percent-of-span segment to encompass the next sequential group of frequency points and repeats the process. The displayed number of points represents the number of points for a given percent of sweep and is based on the max data points, and the sweep start and stop.	SON; SON?; SOF; SOF?
SAMPLERS USED PER SWEEP X SAMPLERS	Sets the number of samplers used per sweep.	SAMP2; SAMP3; SAMP?
PRESS <ENTER> TO SELECT	Pressing the Enter key implements your menu selection.	None
PRESS <AVG/SMOOTH MENU> TO RESET AVG COUNT		

Menu EM, Enhancement Menu



MENU	DESCRIPTION	GPIB COMMAND
SWEPT FREQUENCY GAIN COMPRESSION		None
NOMINAL OFFSET -XX.XX dB	Shows gain of nominal offset. This value is the approximate gain (or loss) of the external devices preceding the AUT (amplifier under test). Specifically, the gain of the amplifier and attenuator combination. This value is used whenever flat test port power is turned OFF (while still existing) to prevent an unexpected jump in the power to the AUT.	NOFST?
CALIBRATE FOR FLATNESS (NO CAL EXISTS)	Calls menu GC_SU8, which provides calibration options.	None
FLATNESS CORRECTION AT -XX.XX dBm	Shows value of the flatness correction.	FPX?
CALIBRATE RECEIVER (NO CAL EXISTS)	Calls menu GC_RCVR, which provides calibration options.	None
NORMALIZE S21 (NOT STORED)	Calls menu GC_NORM.	None
GAIN COMPRESSION POINT (0 dB REF) XX.XX dB	This option is used with marker search functions. Value has a range from 0.05 to 9.99 dB and a default value of 1.00 dB. The search value is [negative] the gain compression point value. The reference is based on (maximum) with tracking ON.	GCMP; GCMP?
TEST AUT	Closes the extended menu and displays the dual channels 1 & 3, with channel 3 active.	None
EXIT APPLICATION	Exits the gain compression application and returns to S-parameter measurements. It restores the measurement setup.	None

*Menu GC1, Swept Frequency Gain Compression*

- SWEPT FREQUENCY GAIN COMPRESSION



- CALIBRATION INSTRUCTIONS -

1. TEST PORT 1 POWER SHOULD BE APPROXIMATELY =  
 $AUT(x \text{ dB compression spec}) - AUT(\text{gain}) - 15 \text{ dB}$
2. PORT 2 INPUT POWER SHOULD BE LESS THAN 0 dBm  
 (UNLESS OPTION 6 IS INSTALLED).
3. NOMINAL OFFSET = APPROXIMATE GAIN (OR LOSS)  
 OF EXTERNAL DEVICES PRECEDING THE AUT.
4. DEFAULT DISPLAY IS DUAL CHANNEL 1-3 IN WHICH  
 CHANNEL 1 =  $b2/1$  [dBm] AND CHANNEL 3 = S21.

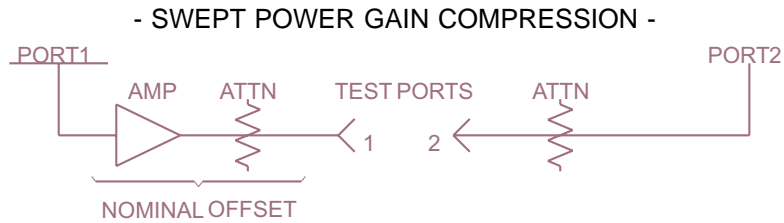
- MEASUREMENT INSTRUCTIONS -

1. AFTER THE AUT IS CONNECTED, NORMALIZES S21.
2. INDICATE THE GAIN COMPRESSION POINT VALUE (x dB)  
 AND SELECT <TEST AUT>.
3. INCREASE TEST PORT 1 POWER UNTIL A 1 dB (or x dB)  
 DECREASE IN S21 IS OBSERVED.

Menu EXT\_GC1, Gain Compression Help Menu 1

MENU	DESCRIPTION	GPIB COMMAND
SWEPT POWER GAIN COMPRESSION		None
SET FREQUENCIES	Calls menu GC_DF2, with it extended menu EXT_GC_DF2. There the you may enter from 1 to 10 discrete frequencies to be used by the application.	None
P START -XX.XX dBm	Defines the power sweep. The start and stop are limited by the actual power control range of the internal source. The stepsize resolution is limited to 0.05 dB.	PSTRT; PSTRT?
P STOP -XX.XX dBm		PSTOP; PSTOP?
STEPSIZE X.XX dB		PSTEP; PSTEP?
ATTENUATION	Calls menu GC_SU2, which lets you set attenuation values.	None
GAIN COMPRESSION POINT (MAX REF) XX.XX dB	This option is used with marker search functions. Value has a range from 0.05 to 9.99 dB and a default value of 1.00 dB. The search value is [negative] the gain compression point value. The reference is based on (maximum) with tracking ON.	GCMP
NOMINAL OFFSET -XX.XX dB	This value is the approximate gain (or loss) of the external devices preceding the AUT. Specifically, the gain of the amplifier and attenuator combination. This value is used whenever power linearity is turned OFF (while still existing) to prevent an unexpected jump in the power to the AUT.	NOFST; NOFST?
MORE	Calls menu GC3, with is companion menu EXT_CG3.	None
PRESS <ENTER> TO SELECT	Pressing the Enter key implements your menu selection.	None

*Menu GC2, Swept Power Gain Compression 1*

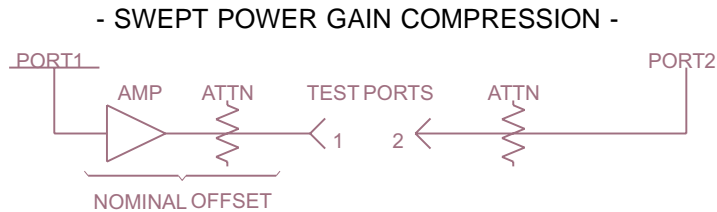


1. SET FREQUENCIES (FROM 1 TO 10 FREQS ALLOWED).
2. P START POWER SHOULD BE APPROXIMATELY =  
 $AUT (x \text{ dB compression spec}) - AUT (\text{gain}) - 15 \text{ dB}$ .
3. P STOP SHOULD BE 20 dB HIGHER THAN P START.
4. PORT 2 INPUT POWER SHOULD BE LESS THAN 0 dB  
(UNLESS OPTION 6 IS INSTALLED).
5. INDICATE THE GAIN COMPRESSION POINT VALUE (x dB).
6. NOMINAL OFFSET = APPROXIMATE GAIN (OR LOSS)  
OF EXTERNAL DEVICES PRECEDING THE AUT.

Menu EXT\_GC2, Gain Compression Help Menu 2

MENU	DESCRIPTION	GPIB COMMAND
SWEPT POWER GAIN COMPRESSION		None
CALIBRATE FOR LINEARITY (NO CAL EXISTS)	Calls menu GC_SU8A with extended menu EXT_GC_SU8A and menu GC_SU8A_ABORT. Upon a successful power linearity calibration, menu GC2 reappears with (CAL EXISTS) and linearity correction ON.	None
LINEARITY ON (OFF) CORRECTION	Toggles the linearity correction on and off.	PSWC0; PSWC1;PSWCX?
CALIBRATE RECEIVER (NO CAL EXISTS)	Calls menu GC_RCVR.	None
S21 OPTIONS (NOT STORED)	Calls menu GC_S21OPT.	None
AUT TEST TYPES		None
GAIN COMPRESSION	Closes the extended menu and displays the dual channels 1 & 3, with channel 3 active. Up to this point, the system is sweeping frequencies. Once <Test AUT> is pressed, the power sweep mode is turned ON and the system goes into single sweep and hold. One power sweep at the current power freq is done and the system goes into hold with Bias and RF ON. Pressing the Hold key will restart the sweep.	CALR
AM/PM	Closes the extended menu and displays dual channel 2 & 4, with Channel 4 becoming active. The power sweep mode is activated and the VNA goes into continuous sweep. The power sweeps at the current power frequency; the marker function is turned off, but markers remain. Channel 2 displays S21 on a Phase graph and Channel 4 displays S21 on a Log Magnitude graph.	SPAMPMT
MULTIPLE FREQ GAIN COMPRESSION	Calls menu GC4.	None
RETURN TO SWEPT FREQUENCY MODE	Returns program to the swept frequency operational mode.	None
PREVIOUS MENU	Returns to previous menu.	None
PRESS <ENTER> TO SELECT OR TURN ON/OFF	Pressing the Enter key implements your menu selection.	None

*Menu GC3, Swept Power Gain Compression 2*



7. LINEARITY CALIBRATION IMPROVES ACCURACY.
8. RECEIVER CALIBRATION IS DONE AT P STOP.  
NORMALIZE S21 AND DISPLAY S21 ARE IS DONE AT P START.
9. DEFAULT DISPLAY IS DUAL CHANNEL 1-3 IN WHICH  
CHANNEL 1 = b2/1 [dBm] AND CHANNEL 3 = S21

-MEASUREMENT INSTRUCTIONS-

1. SELECT THE DESIRED S21 OPTION.
2. SELECT <GAIN COMPRESSION> OR <AM/PM> AUT TEST.
3. MARKERS CAN BE USED TO LOCATE THE 1 dB (or x dB)  
COMPRESSION POINT. CHANGE THE POWER FREQUENCY TO  
MEASURE EACH OF THE OTHER POWER SWEEPS.
4. SELECT <MULTIPLE FREQ GAIN COMPRESSION> TO TEST  
THE AUT AT ALL THE SWEPT POWER FREQUENCIES. THE  
RESULTS ARE COMPUTED UNDER THE ASSUMPTION THAT  
P OUTPUT AT P START IS IN THE AUT'S LINEAR REGION.

MENU	DESCRIPTION	GPIB COMMAND
MULTIPLE FREQUENCY GAIN COMPRESSION		None
TEST AUT	Calls menu GC4_ABORT; and it turns on the power sweep mode and conducts a power sweep at each of the swept power frequencies. The gain compression points are computed under the assumption that P Output at P Start is in the AUT's linear region. The frequency, power in, and power out values are listed in a table. The power out versus frequency number is displayed in on a graph..	None
TEXT DATA TO HARD DISK	When either Text Data to Hard Disk or Text Data to Floppy Disk are selected, the appropriate disk save file menu DSKx is displayed and the table is captured and recorded in a text file.	None
TEXT DATA TO FLOPPY DISK		
SWEPT POWER GAIN COMPRESSION	Calls menu CG3, which let you perform a Swept Power Gain Compression measurement.	None
RETURN TO SWEPT FREQUENCY MODE		None
PRESS <ENTER> TO SELECT	Pressing the Enter key implements your menu selection.	None

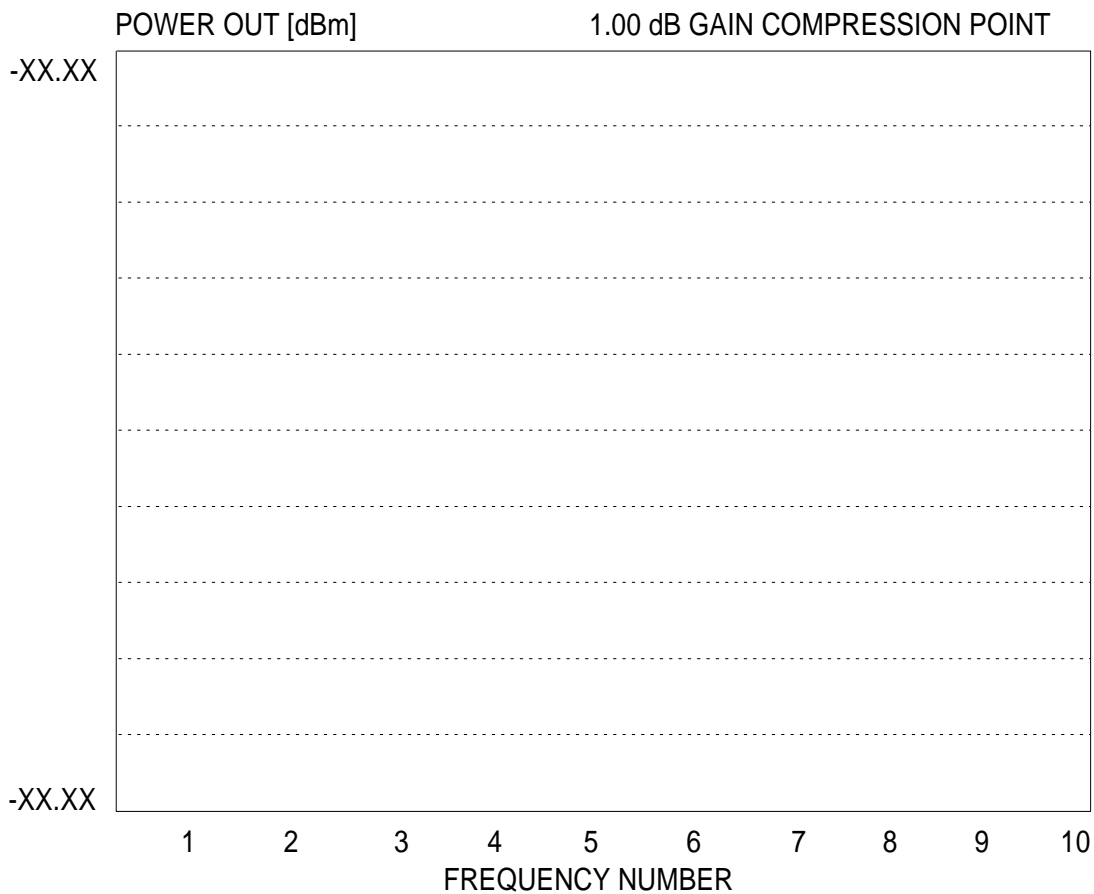
*Menu GC4, Multiple Frequency Gain Compression 1*

MENU	DESCRIPTION	GPIB COMMAND
MULTIPLE FREQUENCY GAIN COMPRESSION		None
TESTING AUT		None
PRESS <CLEAR> TO ABORT	Pressing the Clear key aborts the Multiple Frequency Gain Compression.	None

*Menu GC4\_ABORT, Multiple Frequency Gain Compression 2*

- MULTIPLE FREQUENCY GAIN COMPRESSION POINT -

SWEPT POWER FREQUENCIES	POWER IN	POWER OUT
1. XXX.XXXXXXXXXX GHz	-XX.XX dBm	-XX.XX dBm
2. XXX.XXXXXXXXXX GHz	-XX.XX dBm	-XX.XX dBm
3. XXX.XXXXXXXXXX GHz	-XX.XX dBm	-XX.XX dBm
4. XXX.XXXXXXXXXX GHz	-XX.XX dBm	-XX.XX dBm
5. XXX.XXXXXXXXXX GHz	-XX.XX dBm	-XX.XX dBm
6. XXX.XXXXXXXXXX GHz	-XX.XX dBm	-XX.XX dBm
7. XXX.XXXXXXXXXX GHz	-XX.XX dBm	-XX.XX dBm
8. XXX.XXXXXXXXXX GHz	-XX.XX dBm	-XX.XX dBm
9. XXX.XXXXXXXXXX GHz	-XX.XX dBm	-XX.XX dBm



Menu EXT\_GC4, Gain Compression Help Menu 4



MENU	DESCRIPTION	GPIB COMMAND
SWEPT POWER FREQUENCIES		None
INPUT A FREQ, PRESS <ENTER> TO INSERT	This menu performs in a similar manner to the menu DF2, Insert Individual Frequencies. The list is updated and kept in ascending order. Any frequencies which are added or deleted force a resorting of the list. The user can enter from 1 to 10 swept power frequencies.	None
SWEPT POWER FREQUENCY XXX.XXXXXXXXXX GHz	Enter the swept power frequencies using the keypad or knob. Press <ENTER> to insert into the swept power frequency list	
CLEAR FREQ NUMBER XX	Enter the number of the frequency to remove from the list using the keypad or knob. Press <ENTER> to remove the selection from the list.	
CLEAR ALL	Press <ENTER> to remove all the frequencies from the swept power frequency list.	
FINISHED, RETURN TO POWER SWEEP SETUP	After the swept power frequency list is entered, this returns to menu GC2.	None
PRESS <ENTER> TO SELECT	Pressing the Enter key implements your menu selection.	None

*Menu GC\_DF2, Swept Power Frequencies*

## - MULTIPLE FREQUENCY GAIN COMPRESSION -

## SWEPT POWER FREQUENCIES

1. XXX.XXXXXXXXXX GHz
2. XXX.XXXXXXXXXX GHz
3. XXX.XXXXXXXXXX GHz
4. XXX.XXXXXXXXXX GHz
5. XXX.XXXXXXXXXX GHz
6. XXX.XXXXXXXXXX GHz
7. XXX.XXXXXXXXXX GHz
8. XXX.XXXXXXXXXX GHz
9. XXX.XXXXXXXXXX GHz
10. XXX.XXXXXXXXXX GHz

*Menu EXT\_GC\_DF2, Gain Compression Help Menu*

MENU	DESCRIPTION	GPIB COMMAND
NORMALIZE S21	This menu lets you see if you have a good connection of the throughline before capturing the data by pressing <Enter>. The calibration may be aborted by pressing <Clear>. In both cases, menu GC1 or GC3 is displayed.	NRMS21 SPS21?
CONNECT AUT AND APPLY BIAS		
WAIT FOR ONE COMPLETE SWEEP BEFORE STORING		
PRESS <ENTER> TO STORE	Pressing the Enter key stores the Normalized S21 calibration.	
PRESS <CLEAR> TO ABORT	Pressing the Clear key aborts the Normalized S21 calibration.	

*Menu GC\_NORM, Normalize S21*

MENU	DESCRIPTION	GPIB COMMAND
RECEIVER CALIBRATION	This menu lets you see if you have a good connection of the throughline before capturing the data by pressing <Enter>. The calibration may be aborted by pressing <Clear>. In both cases, menu GC1 or GC2 is displayed.	None
CONNECT THROUGHLINE BETWEEN TEST PORTS		None
INCLUDE ANY COMPONENTS WHICH ARE PART OF THE MEASUREMENT PATH		None
WAIT FOR ONE COMPLETE SWEEP BEFORE STORING		CALR
PRESS <ENTER> TO STORE	Pressing the Enter key stores the receiver calibration.	None
PRESS <CLEAR> TO ABORT	Pressing the Clear key aborts the Receiver calibration.	None

*Menu GC\_RCVR, Receiver Calibration*

MENU	DESCRIPTION	GPIB COMMAND
SWEPT POWER GAIN COMPRESSION		None
PORT 1 ATTN 0*10 dB (0 - 70)	Attenuates the microwave source power at port 1 from 0 to 70 dB, in 10 dB steps. The power is attenuated before being applied to Port 1 for a forward transmission or reflection test (S <sub>21</sub> or S <sub>11</sub> , respectively).	SA1; SA1?
PORT 2 ATTN 0*10 dB (0 - 40)	Attenuates from 0 to 40 dB (10 dB steps) the microwave power being input to Port 2 from the device-under-test (DUT).	TA; TA2?
PREVIOUS MENU	Returns to the previous menu.	None
PRESS <ENTER> TO SELECT	Pressing the Enter key implements your menu selection.	None

*Menu GC\_SU2, Swept Power Gain Compression 2*

MENU	DESCRIPTION	GPIB COMMAND
CALIBRATE FOR LINEAR POWER	The power linearity calibration is done for each of the swept power frequencies across the power sweep range. The resolution of the calibration points is 0.25 dB. The maximum will be equal to the power sweep step size.	None
FORWARD DIRECTION ONLY	The Linear Power Calibration is only done in the forward direction.	None
START LINEAR POWER CALIBRATION	Starts the linear power calibration.	PSWC
PREVIOUS MENU	Returns to previous menu.	None
PRESS <ENTER> TO SELECT	Pressing the Enter key implements your menu selection.	None

*Menu GC\_SU8A, Calibrate for Linear Power*

MENU	DESCRIPTION	GPIB COMMAND
LINEAR POWER CALIBRATION		None
CALIBRATING FOR LINEAR POWER . . .		None
PRESS <CLEAR> TO ABORT	Pressing the Clear key aborts the Linear Power Calibration.	None

*Menu GC\_SU8A-ABORT, Abort Calibrate for Linear Power*

- LINEAR POWER CALIBRATION -

- CALIBRATION INSTRUCTIONS -

LINEAR POWER CALIBRATION ADJUSTS THE SOURCE OUTPUT POWER FOR EACH POWER FREQUENCY POINT ACROSS THE POWER SWEEP RANGE TO PROVIDE A LINEAR POWER LEVEL AT THE TEST PORT (FORWARD DIRECTION ONLY).

- INSTRUCTIONS -

1. PRESET, ZERO, AND CALIBRATE THE POWER METER.
2. CREATE AND ACTIVATE THE POWER METER'S CAL FACTOR LIST FOR THE POWER SENSOR BEING USED.
3. CONNECT THE POWER METER TO THE DEDICATED GPIB INTERFACE AND THE POWER SENSOR TO THE TEST PORT.
4. SELECT <START LINEAR POWER CALIBRATION>.

*Menu EXT\_GC\_SU8A, Gain Compression Help Menu*

MENU	DESCRIPTION	GPIB COMMAND
NORMALIZE S21	This menu lets you see if you have a good connection of the throughline before capturing the data by pressing <Enter>. The calibration may be aborted by pressing <Clear>. In both cases, menu GC1 or GC3 is displayed.	NRMS21 DSPS21?
CONNECT AUT AND APPLY BIAS		None
RESULTS IN A DISPLAY THAT IS NORMALIZED TO THE AUT PERFORMANCE AT P START. NORMALIZATION IS AUTOMATIC FOR EACH POWER SWEEP		None
DISPLAY S21		DSPS21 DSPS21?
CONNECT THROUGH		None
RESULTS IN A DISPLAY SHOWING THE VALUE OF S21 FOR EACH POWER SWEEP		None
WAIT FOR ONE COMPLETE SWEEP BEFORE STORING		NRMS
CONNECT AUT AND APPLY BIAS		None
PRESS <CLEAR> TO ABORT	Pressing the Clear key aborts the Normalized S21 calibration.	None

*Menu GC\_S21OPT, S21 Options*

MENU	DESCRIPTION	GPIB COMMAND
SELECT LABEL ----- ABCDEFGHIJKLM NOPQRSTUVWXYZ 0123456789()- !#\$%&'@^_{}~	Name your file using the rotary knob to select letters, numbers, or both. A letter or number turns red to indicate that the letter/number has been chosen for selection. Pressing the Enter key selects the letter or number. the name you spell out displays in the area below "SELECT NAME." You are allowed up to eight characters for a file name and twelve characters for a label.	None
* ? : \ . SP	For keyboard command line entry.	None
BKSP CLR DONE	Selecting "BKSP" deletes the last letter in the name displayed above. Selecting "CLR" deletes the entire name. Selecting "DONE" signals that you have finished writing the name.	None
TURN KNOB TO INDICATE CHARACTER OR FUNCTION	Use the rotary knob to indicate the letter or number you wish to select. You can use the up-arrow and down-arrow keys to move between rows.	None
PRESS <ENTER> TO SELECT	Pressing the Enter key implements your menu selection. The menu remains on the screen until another menu is selected for display or until the CLEAR/RET LOC key is pressed.	None
NUMBERS MAY ALSO BE SELECTED USING KEYPAD	You may also select numbers and decimals using the keypad.	None

*Menu GP5, Select Name*



MENU	DESCRIPTION	GPIB COMMAND
GPIB ADDRESSES		None
IEEE 488.2 GPIB INTERFACE		None
ADDRESS: 6	Selects the GPIB address for the 37XXXD analyzer. The default address is 6.	ADDGP; ADDGP?
DEDICATED GPIB INTERFACE		None
EXTERNAL SOURCE 1 4	Selects the address for external source 1. The default address is 4.	SRC1ADD; SRC1ADD?
EXTERNAL SOURCE 2 5	Selects the address for external source 2. The default address is 5.	SRC2ADD; SRC2ADD?
PLOTTER 8	Selects the address for a compatible plotter. The default address is 8.	ADDPLT; ADDPLT?
POWER METER 13	Selects the address for a compatible power meter. The default address is 13.	ADDPM; ADDPM?
FREQUENCY COUNTER 7	Selects the address for an external frequency counter. The default address is 7.	ADDFC; ADDFC?

*Menu GP7, Display GPIB Status*

MENU	DESCRIPTION	GPIB COMMAND
NETWORK SETUP		None
ETHERNET ADDRESS 123456789ABC	Displays the ethernet address. This address can be found on the A9 PCB. It is programmed by Motorola in the MVME162.	ADDHW?;
IP ADDRESS XXX.XXX.XXX.XXX	Displays the Internet Protocol address. User can set this address of four numbers. Address numbers range from 0 to 255 separated by periods.	ADDIP; ADDIP?
SUBNET MASK XXX.XXX.XXX.XXX	Displays the address of the subnet mask. User can set this address of four numbers. Address numbers range from 0 to 255 separated by periods.	SUBMSK; SUBMSK?
WARNING DO NOT CHANGE DEFAULT GATEWAY FROM 0.0.0.0 UNLESS ONE EXISTS		
DEFAULT GATEWAY XXX.XXX.XXX.XXX	Displays the Internet Protocol address. User can set this address of four numbers. Address numbers range from 0 to 255 separated by periods.	DEFGT; DEFGT?

*Menu GP8, Network Setup*

MENU	DESCRIPTION	GPIB COMMAND
SELECT GRAPH TYPE		None
LOG MAGNITUDE	Selects a log magnitude graph for display on the active channel's selected S-parameter. The active channel is indicated by its key (CH1, CH2, CH3, CH4) being lit.	MAG
PHASE	Selects a phase graph for display on the active channel.	PHA
LOG MAGNITUDE AND PHASE	Selects log magnitude and phase graphs for display on the active channel.	MPH
SMITH CHART (IMPEDANCE)	Selects a Smith chart for display on the active channel.	SMI; SME; SMC
SWR	Selects an SWR display for the active channel.	SWR
GROUP DELAY	Selects a Group Delay display for the active channel.	DLA
POWER OUT	Provides for measuring output power. The measurement of output power is accomplished by using the b2 (or Tb) measured value normalized to the power supplied to the AUT at Test Port 1. While the b2 parameter is the most meaningful for this graph type, you may use any other parameter.	POW
MORE	Calls additional graph type selections on menu GT2.	None
PRESS <ENTER> TO SELECT AND RESUME CAL	Pressing the Enter key implements your menu selection (and resumes the calibration from where it left off, if in the calibration mode).	None

*Menu GT1/CAL\_GT1, Select Graph Type*

MENU	DESCRIPTION	GPIB COMMAND
SELECT GRAPH TYPE		None
SMITH CHART (ADMITTANCE)	Selects an Admittance Smith chart for display on the active channel's S-parameter.	ISM; ISE; ISC
LINEAR POLAR	Selects a Linear Polar graph for display on the active channel's S-parameter.	PLR
LOG POLAR	Selects a Log Polar graph for display on the active channel's S-parameter.	PLG
LINEAR MAG	Selects a Linear Magnitude graph for display on the active channel's S-parameter.	LIN
LINEAR MAG AND PHASE	Selects Linear Magnitude and Phase graphs for display on the active channel's S-parameter.	LPH
REAL	Selects Real data for display on the active channel's s-parameter.	REL
IMAGINARY	Selects Imaginary data for display on the active channel's s-parameter.	IMG
REAL AND IMAGINARY	Selects both Real and Imaginary data for display on the active channel's S-parameter.	RIM
MORE	Calls additional graph type selections.	None
PRESS <ENTER> TO SELECT AND RESUME CAL	Pressing the Enter key implements your menu selection (and resumes the calibration from where it left off, if in the calibration mode).	None

*Menu GT2/CAL\_GT2, Select Graph Type*

MENU	DESCRIPTION	GPIB COMMAND
SINGLE LIMITS		None
—LOG MAG—		None
UPPER LIMIT ON (OFF) XXX.XXX dB	Turns the Upper Limit line on or off for the active channel. For your convenience, the arbitrarily set limit lines allow you to delineate a go/no go line on your Log Mag display beyond which the measured values are unacceptable.	UPL0; UPL1; UPLX?
LOWER LIMIT ON(OFF) XXX.XXX dB	Turns the Lower Limit line on or off for the active channel on your Log Mag display.	LOL0; LOL1; LOLX?
READOUT LIMIT	Calls menu LF1, which shows points where the current S-parameter intercepts the lower limit.	None
–PHASE–		None
UPPER LIMIT ON (OFF) XXX.XXX°	Turns the Upper Limit line on or off for the active channel on your Phase display.	UPL0; UPL1; UPLX?
LOWER LIMIT ON(OFF) XXX.XXX °	Turns the Lower Limit line on or off for the active channel on your Phase display.	LOL0; LOL1; LOLX?
READOUT LIMIT	Calls menu LF2, which shows points where the current S-parameter intercepts the lower limit.	None
DISPLAY ON (OFF) LIMITS	Enables both limit lines for the active channel on both the Log-Mag and Phase graphs.	LON; LOF; LON?
TEST LIMITS	Calls menu LTST, which provides choices for testing the limits.	None
SEGMENTED LIMITS	Calls a menu in the LS series (LSX), which lets you set segmented limit lines.	None
PRESS <ENTER> TO SELECT OR TURN ON/OFF	Pressing the Enter key implements your menu selection.	None

*Menu L1, Set Limits—Magnitude and Phase*

MENU	DESCRIPTION	GPIB COMMAND
SINGLE LIMITS		None
–LINEAR POLAR–		None
UPPER LIMIT ON (OFF) XXX.XXX mU	Turns the Upper Limit line on or off for the active channel. For your convenience, the arbitrarily set limit lines allow you to delineate a go/no go line on your Linear Polar display beyond which the measured values are unacceptable.	UPL0; UPL1; UPLX?
LOWER LIMIT ON(OFF) XXX.XXX mU	Turns the Lower Limit line on or off for the active channel on your Linear Polar display.	LOL0; LOL1; LOLX?
DISPLAY ON (OFF) LIMITS	Enables both previously set limit lines to appear for the active channel on your polar display.	LON; LOF; LON?
TEST LIMITS	Calls menu LTST, which provides choices for testing the limits.	None
PRESS <ENTER> TO SELECT OR TURN ON/OFF	Pressing the Enter key implements your menu selection.	None

*Menu L2, Set Limits—Linear Polar*

MENU	DESCRIPTION	GPIB COMMAND
SINGLE LIMITS		None
–SMITH CHART–		None
UPPER LIMIT ON (OFF) XXX.XXX mU	Turns the Upper Limit line on or off for the active channel. For your convenience, the arbitrarily set limit lines allow you to delineate a go/no go line on your Smith Chart display beyond which the measured values are unacceptable.	UPL0; UPL1; UPLX?
LOWER LIMIT ON(OFF) XXX.XXX mU	Turns the Lower Limit line on or off for the active channel on your Smith Chart.	LOL0; LOL1; LOLX?
DISPLAY ON (OFF) LIMITS	Enables both previously set limit lines to appear for the active channel on your Smith Chart.	LON; LOF; LON?
TEST LIMITS	Calls menu LTST, which provides choices for testing the limits.	None
PRESS <ENTER> TO SELECT OR TURN ON/OFF	Pressing the Enter key implements your menu selection.	None

*Menu L3, Set Limits—Linear Polar/Smith Chart*

MENU	DESCRIPTION	GPIB COMMAND
SINGLE LIMITS		None
–LOG MAG–		None
UPPER LIMIT ON (OFF) XXX.XXX dB	Turns the Upper Limit line on or off for the active channel. For your convenience, the arbitrarily set limit lines allow you to delineate a go/no go line on your Log Mag display beyond which the measured values are unacceptable.	UPL0; UPL1; UPLX?
LOWER LIMIT ON(OFF) XXX.XXX dB	Turns the Lower Limit line on or off for the active channel on your Log Mag display.	LOL0; LOL1; LOLX?
READOUT LIMIT	Calls menu LF1, which shows points where the current S-parameter intercepts the lower limit.	None
DISPLAY ON (OFF) LIMITS	Enables both previously set limit lines to appear for the active channel on your Log Mag display.	LON; LOF; LON?
TEST LIMITS	Calls menu LTST, which provides choices for testing the limits.	None
SEGMENTED LIMITS	Calls a menu in the LS series (LSX), which lets you set segmented limit lines.	None
PRESS <ENTER> TO SELECT OR TURN ON/OFF	Pressing the Enter key implements your menu selection.	None

*Menu L4, Set Limits—Log Magnitude*



MENU	DESCRIPTION	GPIB COMMAND
SINGLE LIMITS		None
–PHASE–		None
UPPER LIMIT ON (OFF) XXX.XXX °	Turns the Upper Limit line on or off for the active channel. For your convenience, the arbitrarily set limit lines allow you to delineate a go/no go line on your Phase display beyond which the measured values are unacceptable.	UPL0; UPL1; UPLX?
LOWER LIMIT ON(OFF) XXX.XXX °	Turns the Lower Limit line on or off for the active channel on your Phase display.	LOL0; LOL1; LOLX?
READOUT LIMIT	Calls menu LF1, which shows points where the current S-parameter intercepts the lower limit.	None
DISPLAY ON (OFF) LIMITS	Enables both limit lines for the active channel on a phase graph.	LON; LOF; LON?
TEST LIMITS	Calls menu LTST, which provides choices for testing the limits.	None
SEGMENTED LIMITS	Calls a menu in the LS series (LSX), which lets you set segmented limit lines.	None
PRESS <ENTER> TO SELECT OR TURN ON/OFF	Pressing the Enter key implements your menu selection.	None

*Menu L5, Set Limits—Phase*

MENU	DESCRIPTION	GPIB COMMAND
SINGLE LIMITS		None
–LOG POLAR–		None
UPPER LIMIT ON (OFF) XXX.XXX dB	Turns the Upper Limit line on or off for the active channel. For your convenience, the arbitrarily set limit lines allow you to delineate a go/no go line on your Log Polar display beyond which the measured values are unacceptable.	UPL0; UPL1; UPLX?
LOWER LIMIT ON(OFF) XXX.XXX dB	Turns the Lower Limit line on or off for the active channel on your Log Polar display.	LOL0; LOL1; LOLX?
DISPLAY ON (OFF) LIMITS	Enables both previously set limit lines to appear for the active channel on your Log Polar display.	LON; LOF; LON?
TEST LIMITS	Calls menu LTST, which provides choices for testing the limits.	None
PRESS <ENTER> TO SELECT OR TURN ON/OFF	Pressing the Enter key implements your menu selection.	None

*Menu L6, Set Limits—Log Polar*

MENU	DESCRIPTION	GPIB COMMAND
SINGLE LIMITS		None
–GROUP DELAY–		None
UPPER LIMIT ON (OFF) XXX.XXX fs	Turns the Upper Limit line on or off for the active channel. For your convenience, the arbitrarily set limit lines allow you to delineate a go/no go line on your Group Delay display beyond which the measured values are unacceptable.	UPL0; UPL1; UPLX?
LOWER LIMIT ON(OFF) XXX.XXX fs	Turns the Lower Limit line on or off for the active channel on your Group Delay display.	LOL0; LOL1; LOLX?
READOUT LIMIT	Calls menu LF1, which shows points where the current S-parameter intercepts the lower limit.	None
DISPLAY ON (OFF) LIMITS	Enables both previously set limit lines to appear for the active channel on your Group Delay display.	LON; LOF; LON?
TEST LIMITS	Calls menu LTST, which provides choices for testing the limits.	None
SEGMENTED LIMITS	Calls a menu in the LS series (LSX), which lets you set segmented limit lines.	None
PRESS <ENTER> TO SELECT OR TURN ON/OFF	Pressing the Enter key implements your menu selection.	None

*Menu L7, Set Limits—Group Delay*

MENU	DESCRIPTION	GPIB COMMAND
SINGLE LIMITS		None
–LINEAR MAG–		None
UPPER LIMIT ON (OFF) XXX.XXX pU	Turns the Upper Limit line on or off for the active channel. For your convenience, the arbitrarily set limit lines allow you to delineate a go/no go line on your Linear Mag display beyond which the measured values are unacceptable.	UPL0; UPL1; UPLX?
LOWER LIMIT ON(OFF) XXX.XXX pU	Turns the Lower Limit line on or off for the active channel on your Linear Mag display.	LOL0; LOL1; LOLX?
READOUT LIMIT	Calls menu LF1, which shows points where the current S-parameter intercepts the lower limit.	None
DISPLAY ON (OFF) LIMITS	Enables both previously set limit lines to appear for the active channel on your Linear Mag display.	LON; LOF; LON?
TEST LIMITS	Calls menu LTST, which provides choices for testing the limits.	None
SEGMENTED LIMITS	Calls a menu in the LS series (LSX), which lets you set segmented limit lines.	None
PRESS <ENTER> TO SELECT OR TURN ON/OFF	Pressing the Enter key implements your menu selection.	None

*Menu L8, Set Limits—Linear Magnitude*

MENU	DESCRIPTION	GPIB COMMAND
SINGLE LIMITS		None
-LINEAR MAG-		None
UPPER LIMIT ON (OFF) XXX.XXX pU	Turns the Upper Limit line on or off for the active channel. For your convenience, the arbitrarily set limit lines allow you to delineate a go/no go line on your Linear Mag display beyond which the measured values are unacceptable.	UPL0; UPL1; UPLX?
LOWER LIMIT ON(OFF) XXX.XXX pU	Turns the Lower Limit line on or off for the active channel on your Linear Mag display.	LOL0; LOL1; LOLX?
READOUT LIMIT	Calls menu LF4, which shows points where the current S-parameter intercepts the lower limit.	None
-PHASE-		None
UPPER LIMIT ON (OFF) XXX.XXX °	Turns the Upper Limit line on or off for the active channel. For your convenience, the arbitrarily set limit lines allow you to delineate a go/no go line on your polar display beyond which the measured values are unacceptable.	UPL0; UPL1; UPLX?
LOWER LIMIT ON(OFF) XXX.XXX °	Turns the Lower Limit line on or off for the active channel on your Phase display.	LOL0; LOL1; LOLX?
READOUT LIMIT	Calls menu LF2, which shows points where the current S-parameter intercepts the lower limit.	None
DISPLAY ON (OFF) LIMITS	Enables both previously set limit lines to appear for the active channel on your Phase display.	LON; LOF; LON?
TEST LIMITS	Calls menu LTST, which provides choices for testing the limits.	None
SEGMENTED LIMITS	Calls a menu in the LS series (LSX), which lets you set segmented limit lines.	None
PRESS <ENTER> TO SELECT OR TURN ON/OFF	Pressing the Enter key implements your menu selection.	None

*Menu L9, Set Limits—Linear Magnitude and Phase*

MENU	DESCRIPTION	GPIB COMMAND
SINGLE LIMITS		None
–REAL–		None
UPPER LIMIT ON (OFF) XXX.XXX pU	Turns the Upper Limit line on or off for the active channel. For your convenience, the arbitrarily set limit lines allow you to delineate a go/no go line on your Real display beyond which the measured values are unacceptable.	UPL0; UPL1; UPLX?
LOWER LIMIT ON(OFF) XXX.XXX pU	Turns the Lower Limit line on or off for the active channel on your Real display.	LOL0; LOL1; LOLX?
READOUT LIMIT	Calls menu LF6, which shows points where the current S-parameter intercepts the lower limit.	None
DISPLAY ON (OFF) LIMITS	Enables both previously set limit lines to appear for the active channel on your Real values display.	LON; LOF; LON?
TEST LIMITS	Calls menu LTST, which provides choices for testing the limits.	None
SEGMENTED LIMITS	Calls a menu in the LS series (LSX), which lets you set segmented limit lines.	None
PRESS <ENTER> TO SELECT OR TURN ON/OFF	Pressing the Enter key implements your menu selection.	None

*Menu L10, Set Limits—Real Values*

MENU	DESCRIPTION	GPIB COMMAND
SINGLE LIMITS		None
–IMAGINARY–		None
UPPER LIMIT ON (OFF) XXX.XXX pU	Turns the Upper Limit line on or off for the active channel. For your convenience, the arbitrarily set limit lines allow you to delineate a go/no go line on your Imaginary display beyond which the measured values are unacceptable.	UPL0; UPL1; UPLX?
LOWER LIMIT ON(OFF) XXX.XXX pU	Turns the Lower Limit line on or off for the active channel on your Imaginary display.	LOL0; LOL1; LOLX?
READOUT LIMIT	Calls menu LF7, which shows points where the current S-parameter intercepts the lower limit.	None
DISPLAY ON (OFF) LIMITS	Enables both previously set limit lines to appear for the active channel on your Imaginary values display.	LON; LOF; LON?
TEST LIMITS	Calls menu LTST, which provides choices for testing the limits.	None
SEGMENTED LIMITS	Calls a menu in the LS series (LSX), which lets you set segmented limit lines.	None
PRESS <ENTER> TO SELECT OR TURN ON/OFF	Pressing the Enter key implements your menu selection.	None

*Menu L11, Set Limits—Imaginary Values*

MENU	DESCRIPTION	GPIB COMMAND
SINGLE LIMITS		None
–REAL–		None
UPPER LIMIT ON (OFF) XXX.XXX pU	Turns the Upper Limit line on or off for the active channel. For your convenience, the arbitrarily set limit lines allow you to delineate a go/no go line on your Real display beyond which the measured values are unacceptable.	UPL0; UPL1; UPLX?
LOWER LIMIT ON(OFF) XXX.XXX pU	Turns the Lower Limit line on or off for the active channel on your Real display.	LOL0; LOL1; LOLX?
READOUT LIMIT	Calls menu LF6, which shows points where the current S-parameter intercepts the lower limit.	None
–IMAGINARY–		None
UPPER LIMIT ON (OFF) XXX.XXX pU	Turns the Upper Limit line on or off for the active channel. For your convenience, the arbitrarily set limit lines allow you to delineate a go/no go line on your Imaginary display beyond which the measured values are unacceptable.	UPL0; UPL1; UPLX?
LOWER LIMIT ON(OFF) XXX.XXX pU	Turns the Lower Limit line on or off for the active channel on your Imaginary display.	LOL0; LOL1; LOLX?
READOUT LIMIT	Displays menu LF7, which shows points where the current S-parameter intercepts the lower limit.	None
DISPLAY ON (OFF) LIMITS	Enables both previously set limit lines to appear for the active channel on your Imaginary values display.	LON; LOF; LON?
TEST LIMITS	Calls menu LTST, which provides choices for testing the limits.	None
SEGMENTED LIMITS	Calls a menu in the LS series (LSX), which lets you set segmented limit lines.	None
PRESS TO SELECT OR TURN ON/OFF	Pressing the Enter key implements your menu selection.	None

*Menu L12, Set Limits—Real and Imaginary Values*



MENU	DESCRIPTION	GPIB COMMAND
SINGLE LIMITS		None
—SWR—		None
UPPER LIMIT ON (OFF) XXX.XXX pU	Turns the Upper Limit line on or off for the active channel. For your convenience, the arbitrarily set limit lines allow you to delineate a go/no go line on your SWR display beyond which the measured values are unacceptable.	UPL0; UPL1; UPLX?
LOWER LIMIT ON(OFF) XXX.XXX pU	Turns the Lower Limit line on or off for the active channel on your SWR display.	LOL0; LOL1; LOLX?
READOUT LIMIT	Calls menu LF5, which shows points where the current S-parameter intercepts the lower limit.	None
DISPLAY ON (OFF) LIMITS	Enables both previously set limit lines to appear for the active channel.	LON; LOF; LON?
TEST LIMITS	Calls menu LTST, which provides choices for testing the limits.	None
SEGMENTED LIMITS	Calls a menu in the LS series (LSX), which lets you set segmented limit lines.	None
PRESS <ENTER> TO SELECT OR TURN ON/OFF	Pressing the Enter key implements your menu selection.	None

*Menu L13, Set Limits—SWR*

MENU	DESCRIPTION	GPIB COMMAND
SINGLE LIMITS		None
—POWER OUT—		None
UPPER LIMIT ON (OFF) XXX.XXX dBm	Turns the Upper Limit line on or off for the active channel. For your convenience, the arbitrarily set limit lines allow you to delineate a go/no go line on your power display beyond which the measured values are unacceptable.	UPL0; UPL1; UPLX?
LOWER LIMIT ON(OFF) XXX.XXX dBm	Turns the Lower Limit line on or off for the active channel on your power display.	LOL0; LOL1; LOLX?
READOUT LIMIT	Calls menu LF5, which shows points where the current S-parameter intercepts the lower limit.	None
DISPLAY ON (OFF) LIMITS	Enables both previously set limit lines to appear for the active channel.	LON; LOF; LON?
TEST LIMITS	Calls menu LTST, which provides choices for testing the limits.	None
SEGMENTED LIMITS	Calls a menu in the LS series (LSX), which lets you set segmented limit lines.	None
PRESS <ENTER> TO SELECT OR TURN ON/OFF	Pressing the Enter key implements your menu selection.	None

*Menu L14, Set Limits—Power Out*

MENU	DESCRIPTION	GPIB COMMAND
DEFINE UPPER SEGS	Define the upper limit segment.	None
SEGMENT ON (OFF) X	Enter the segment number that you want to define, and turn it on or off.	US1 - US10; USX?
START POSITION		None
HORIZONTAL XXX.XXXXXXXXXX GHz	Enter the start horizontal value in GHz, seconds, meter, or points (domain dependent).	STH; STH?
VERTICAL XX.XXXXXX dB	Enter the start vertical value in dB, degrees, units, or seconds (graph-type dependent).	STV; STV?
STOP POSITION		None
HORIZONTAL XXX.XXXXXXXXXX GHz	Enter the stop horizontal value in GHz, seconds, meter, or points (domain dependent).	STH; STH?
VERTICAL XX.XXXXXX dB	Enter the stop vertical value in dB, degrees, units, or seconds (graph-type dependent).	STV; STV?
BEGIN NEXT	Turns the next segment on and sets its start and stop positions to the previous segment's stop position.	BEGN
ATTACH NEXT	Turns the next segment on and sets its start positions to the previous segment's stop position.	ATTN
CLEAR SEGMENT	Turns the current segment-to-define off and sets its start equal to its stop.	CAS
PREVIOUS MENU	Returns to the previous menu.	None
PRESS <ENTER> TO SELECT OR TURN ON/OFF	Pressing the Enter key implements your menu selection.	None

*Menu LD1, Define Upper Limit Segment*

MENU	DESCRIPTION	GPIB COMMAND
DEFINE LOWER SEGS	Define the upper limit segment.	None
SEGMENT ON (OFF) X	Enter the segment number that you want to define, and turn it on or off.	LS1 - LS10; LSX?
START POSITION		None
HORIZONTAL XXX.XXXXXXXXXX GHz	Enter the start horizontal value in GHz, seconds, meter, or points (domain dependent).	STH; STH?
VERTICAL XX.XXXXXX dB	Enter the start vertical value in dB, degrees, units, or seconds (graph-type dependent).	STV; STV?
STOP POSITION		None
HORIZONTAL XXX.XXXXXXXXXX GHz	Enter the stop horizontal value in GHz, seconds, meter, or points (domain dependent).	STH; STH?
VERTICAL XX.XXXXXX dB	Enter the stop vertical value in dB, degrees, units, or seconds (graph-type dependent).	STV; STV?
BEGIN NEXT	Turns the next segment on and sets its start and stop positions to the previous segment's stop position.	
ATTACH NEXT	Turns the next segment on and sets its start positions to the previous segment's stop position.	
CLEAR SEGMENT	Turns the current segment-to-define off and sets its start equal to its stop.	CAS
PREVIOUS MENU	Returns to the previous menu.	None
PRESS <ENTER> TO SELECT OR TURN ON/OFF	Pressing the Enter key implements your menu selection.	None

*Menu LD2, Define Lower Limit Segmen*

MENU	DESCRIPTION	GPIB COMMAND
READOUT LIMIT INTERCEPTS		None
—LOG MAG—		None
UPPER LIMIT (REF) XXX.XXX dB	Lets you set the UPPER LIMIT (REF) limit line. Changing this value also moves the lower limit line by the LIMIT DIFFERENCE amount.	LUP; LUP?; LUP2; LUP2?
LOWER LIMITdB XXX.XXX dB	Lets you set the LOWER LIMIT dB limit line. Changing this value also changes the LIMIT DIFFERENCE amount relative to the UPPER LIMIT (REF) value.	LLO; LLO?; LLO2; LLO2?
LIMIT DIFFERENCE (UPPER-LOWER) XXX.XXX dB	Lets you set the LIMIT DIFFERENCE amount. Changing this value also changes the lower limit value relative to the UPPER LIMIT (REF) value.	LFD; LFD?; LFD2; LFD2?
INTERCEPTS AT LOWER LIMIT  XXX.XXXXXXXXXX GHz XXX.XXXXXXXXXX GHz XXX.XXXXXXXXXX GHz XXX.XXXXXXXXXX GHz XXX.XXXXXXXXXX GHz	Displays at which frequencies the data intercepts the lower limit. May be interpolated.	None

*Menu LF1, Set Limit Frequencies—Log Mag*

MENU	DESCRIPTION	GPIB COMMAND
READOUT LIMIT INTERCEPTS		None
—PHASE—		None
UPPER LIMIT (REF) XXX.XXX °	Lets you set the UPPER LIMIT (REF) limit line. Changing this value also moves the lower limit line by the LIMIT DIFFERENCE amount.	LUP; LUP?; LUP2; LUP2?
LOWER LIMITdB XXX.XXX °	Lets you set the LOWER LIMIT dB limit line. Changing this value also changes the LIMIT DIFFERENCE amount relative to the UPPER LIMIT (REF) value.	LLO; LLO?; LLO2; LLO2?
LIMIT DIFFERENCE (UPPER-LOWER)	Lets you set the LIMIT DIFFERENCE amount. Changing this value also changes the lower limit value relative to the UPPER LIMIT (REF) value.	LFD; LFD?; LFD2; LFD2?
INTERCEPTS AT LOWER LIMIT  XXX.XXXXXXXXXX GHz XXX.XXXXXXXXXX GHz XXX.XXXXXXXXXX GHz XXX.XXXXXXXXXX GHz XXX.XXXXXXXXXX GHz	Displays at which frequencies the data intercepts the lower limit. May be interpolated.	None

*Menu LF2, Set Limit Frequencies—Phase*

MENU	DESCRIPTION	GPIB COMMAND
READOUT LIMIT INTERCEPTS		None
—GROUP DELAY—		None
UPPER LIMIT (REF) XXX.XXX fs	Lets you set the UPPER LIMIT (REF) limit line. Changing this value also moves the lower limit line by the LIMIT DIFFERENCE amount.	LUP; LUP?; LUP2; LUP2?
LOWER LIMIT XXX.XXX fs	Lets you set the LOWER LIMIT dB limit line. Changing this value also changes the LIMIT DIFFERENCE amount relative to the UPPER LIMIT (REF) value.	LLO; LLO?; LLO2; LLO2?
LIMIT DIFFERENCE (UPPER-LOWER)	Lets you set the LIMIT DIFFERENCE amount. Changing this value also changes the lower limit value relative to the UPPER LIMIT (REF) value.	LFD; LFD?; LFD2; LFD2?
INTERCEPTS AT LOWER LIMIT  XXX.XXXXXXXXXX GHz XXX.XXXXXXXXXX GHz XXX.XXXXXXXXXX GHz XXX.XXXXXXXXXX GHz XXX.XXXXXXXXXX GHz	Displays at which frequencies the data intercepts the lower limit. May be interpolated.	None

*Menu LF3, Set Limit Frequencies—Group Delay*

MENU	DESCRIPTION	GPIB COMMAND
READOUT LIMIT INTERCEPTS		None
—LINEAR MAG—		None
UPPER LIMIT (REF) XXX.XXX pU	Lets you set the UPPER LIMIT (REF) limit line. Changing this value also moves the lower limit line by the LIMIT DIFFERENCE amount.	LUP; LUP?; LUP2; LUP2?
LOWER LIMIT XXX.XXX pU	Lets you set the LOWER LIMIT dB limit line. Changing this value also changes the LIMIT DIFFERENCE amount relative to the UPPER LIMIT (REF) value.	LLO; LLO?; LLO2; LLO2?
LIMIT DIFFERENCE (UPPER-LOWER) XXX.XXX pU	Lets you set the LIMIT DIFFERENCE amount. Changing this value also changes the lower limit value relative to the UPPER LIMIT (REF) value.	LFD; LFD?; LFD2; LFD2?
INTERCEPTS AT LOWER LIMIT  XXX.XXXXXXXXXX GHz XXX.XXXXXXXXXX GHz XXX.XXXXXXXXXX GHz XXX.XXXXXXXXXX GHz XXX.XXXXXXXXXX GHz	Displays at which frequencies the data intercepts the lower limit. May be interpolated.	None

*Menu LF4, Set Limit Frequencies—Linear Mag*



MENU	DESCRIPTION	GPIB COMMAND
SET LIMIT FREQUENCIES		None
—SWR—		None
UPPER LIMIT (REF) XXX.XXX pU	Lets you set the UPPER LIMIT (REF) limit line. Changing this value also moves the lower limit line by the LIMIT DIFFERENCE amount.	LUP; LUP?; LUP2; LUP2?
LOWER LIMIT XXX.XXX pU	Lets you set the LOWER LIMIT dB limit line. Changing this value also changes the LIMIT DIFFERENCE amount relative to the UPPER LIMIT (REF) value.	LLO; LLO?; LLO2; LLO2?
LIMIT DIFFERENCE (UPPER-LOWER) XXX.XXX pU	Lets you set the LIMIT DIFFERENCE amount. Changing this value also changes the lower limit value relative to the UPPER LIMIT (REF) value.	LFD; LFD?; LFD2; LFD2?
INTERCEPTS AT LOWER LIMIT  XXX.XXXXXXXXXX GHz XXX.XXXXXXXXXX GHz XXX.XXXXXXXXXX GHz XXX.XXXXXXXXXX GHz XXX.XXXXXXXXXX GHz	Displays at which frequencies the data intercepts the lower limit. May be interpolated.	None

*Menu LF5, Set Limit Frequencies—SWR*

MENU	DESCRIPTION	GPIB COMMAND
SET LIMIT FREQUENCIES		None
—REAL—		None
UPPER LIMIT (REF) XXX.XXX pU	Lets you set the UPPER LIMIT (REF) limit line. Changing this value also moves the lower limit line by the LIMIT DIFFERENCE amount.	LUP; LUP?; LUP2; LUP2?
LOWER LIMIT XXX.XXX pU	Lets you set the LOWER LIMIT dB limit line. Changing this value also changes the LIMIT DIFFERENCE amount relative to the UPPER LIMIT (REF) value.	LLO; LLO?; LLO2; LLO2?
LIMIT DIFFERENCE (UPPER-LOWER)	Lets you set the LIMIT DIFFERENCE amount. Changing this value also changes the lower limit value relative to the UPPER LIMIT (REF) value.	LFD; LFD?; LFD2; LFD2?
INTERCEPTS AT LOWER LIMIT  XXX.XXXXXXXXXX GHz XXX.XXXXXXXXXX GHz XXX.XXXXXXXXXX GHz XXX.XXXXXXXXXX GHz XXX.XXXXXXXXXX GHz	Displays at which frequencies the data intercepts the lower limit. May be interpolated.	None

*Menu LF6, Set Limit Frequencies—Real*

MENU	DESCRIPTION	GPIB COMMAND
SET LIMIT FREQUENCIES		None
—IMAGINARY—		None
UPPER LIMIT (REF) XXX.XXX pU	Lets you set the UPPER LIMIT (REF) limit line. Changing this value also moves the lower limit line by the LIMIT DIFFERENCE amount.	LUP; LUP?; LUP2; LUP2?
LOWER LIMIT XXX.XXX pU	Lets you set the LOWER LIMIT dB limit line. Changing this value also changes the LIMIT DIFFERENCE amount relative to the UPPER LIMIT (REF) value.	LLO; LLO?; LLO2; LLO2?
LIMIT DIFFERENCE (UPPER-LOWER)	Lets you set the LIMIT DIFFERENCE amount. Changing this value also changes the lower limit value relative to the UPPER LIMIT (REF) value.	LFD; LFD?; LFD2; LFD2?
INTERCEPTS AT LOWER LIMIT  XXX.XXXXXXXXXX GHz XXX.XXXXXXXXXX GHz XXX.XXXXXXXXXX GHz XXX.XXXXXXXXXX GHz XXX.XXXXXXXXXX GHz	Displays at which frequencies the data intercepts the lower limit. May be interpolated.	None

*Menu LF7, Set Limit Frequencies—Imaginary*

MENU	DESCRIPTION	GPIB COMMAND
READOUT LIMIT INTERCEPTS		None
—POWER OUT—		None
UPPER LIMIT (REF) XXX.XXX dBm	Lets you set the UPPER LIMIT (REF) limit line. Changing this value also moves the lower limit line by the LIMIT DIFFERENCE amount.	LUP; LUP?; LUP2; LUP2?
LOWER LIMIT XXX.XXX dBm	Lets you set the LOWER LIMIT dB limit line. Changing this value also changes the LIMIT DIFFERENCE amount relative to the UPPER LIMIT (REF) value.	LLO; LLO?; LLO2; LLO2?
LIMIT DIFFERENCE (UPPER-LOWER) XXX.XXX dBm	Lets you set the LIMIT DIFFERENCE amount. Changing this value also changes the lower limit value relative to the UPPER LIMIT (REF) value.	LFD; LFD?; LFD2; LFD2?
INTERCEPTS AT LOWER LIMIT  XXX.XXXXXXXXXX GHz XXX.XXXXXXXXXX GHz XXX.XXXXXXXXXX GHz XXX.XXXXXXXXXX GHz XXX.XXXXXXXXXX GHz	Displays at which frequencies the data intercepts the lower limit. May be interpolated.	None

*Menu LF8, Set Limit Frequencies—Power Out*

MENU	DESCRIPTION	GPIB COMMAND
SEGMENTED LIMITS		None
-XXXXXXX-	Displays the currently active channel's graph type.	None
UPPER LIMIT ON(OFF)	Turns the Upper Limit line on or off for the active channel.	SLU1; SLU0; SLUX?
DEFINE UPPER	Calls menu LD1, which lets you define an upper segment value.	None
LOWER LIMIT ON(OFF)	Turns the Lower Limit line on or off for the active channel.	SLL1; SLL0; SLLX?
DEFINE LOWER	Calls menu LD2, which lets you define a lower segment value.	None
SEGMENTED OFFSETS		None
HORIZONTAL XXXX GHz	Enter the horizontal offset to be applied to all of the channel's segmented limits, in GHz, seconds, meters, or points (domain dependent).	SLH; SLH?
VERTICAL XXXX dB	Enter the vertical offset to be applied to all of the channel's segmented limits, in dB, degrees, units, or seconds (graph-type dependent).	SLV; SLV?
CLEAR ALL	Clears all segments.	SLC
DISPLAY ON (OFF) LIMITS	Toggle between on and off to display the active channel's limits.	LON; LOF; LON?
TEST LIMITS	Calls menu LTST, which lets test for limits.	None
SINGLE LIMITS	Returns to the appropriate single limits menu.	None
PRESS <ENTER> TO SELECT OR TURN ON/OFF	Pressing the Enter key implements your menu selection.	None

*Menu LSX, Segmented Limits*

MENU	DESCRIPTION	GPIB COMMAND
TEST LIMITS		None
LIMIT ON (OFF) TESTING	Turns limit testing for all displayed channels on or off.	LON; LOF; LON?
BEEP FOR ON (OFF) TEST FAILURE	Turns beeper on or off when limit test fails.	LB0; LB1; LBX?
LIMIT TEST TTL FAIL CONDITION TTL LOW/TTL HIGH	Selects between a TTL high or TTL low to indicate that the limit test has failed.	LVH; LVL; LVX?
CHANNEL 1 TEST PASS (FAIL)	Displays result of Channel 1 limit test.	
CHANNEL 2 TEST PASS (FAIL)	Displays result of Channel 2 limit test.	
CHANNEL 3 TEST PASS (FAIL)	Displays result of Channel 3 limit test.	
CHANNEL 4 TEST PASS (FAIL)	Displays result of Channel 4 limit test.	
PRESS <ENTER> TO SELECT OR TURN ON/OFF	Pressing the Enter key implements your menu selection.	None

*Menu LTST, Test Limits*

MENU	DESCRIPTION	GPIB COMMAND
SET MARKERS		None
MARKER 1 ON (OFF) XXX.XXXXXXXXXX GHz	Turns Marker 1 on or off (activates or deactivates). When on (active), the frequency, time, or distance may be set using the keypad or rotary knob.  NOTE: In this text, markers are referred to as being active and as being selected. Any marker that has been turned on and assigned a frequency is considered to be selected. The marker to which the cursor presently points is considered to be active. The active marker is the only one for which you can change the frequency.	MR1; MR1?; MK1 MK1?; OM1; MO1
MARKER 2 ΔREF ON (OFF) XXX.XXXXXXXXXX GHz	Turns Marker 2 on or off (activates or deactivates). When on (active), the frequency, time, or distance may be set using the keypad or rotary knob.	MR2; MR2?; MK2 MK2?; OM2; MO2
MARKER 3 ON (OFF) XXX.XXXXXXXXXX GHz	Turns Marker 3 on or off (activates or deactivates). When on (active), the frequency, time, or distance may be set using the keypad or rotary knob.	MR31; MR3?; MK3 MK3?; OM3; MO3
MARKER 4 ON (OFF) XXX.XXXXXXXXXX GHz	Turns Marker 4 on or off (activates or deactivates). When on (active), the frequency, time, or distance may be set using the keypad or rotary knob.	MR4; MR4?; MK4 MK4?; OM4; MO4
MARKER 5 ON (OFF) XXX.XXXXXXXXXX GHz	Turns Marker 5 on or off (activates or deactivates). When on (active), the frequency, time, or distance may be set using the keypad or rotary knob.	MR5; MR5?; MK5 MK5?; OM5; MO5
MARKER 6 ON (OFF) XXX.XXXXXXXXXX GHz	Turns Marker 6 on or off (activates or deactivates). When on (active), the frequency, time, or distance may be set using the keypad or rotary knob.	MR6; MR6?; MK6 MK6?; OM6; MO6
DISPLAY ON (OFF) MARKERS	Displays selected markers.	MON; MON?; MOF
ΔREF MODE ON (OFF)	Selects the ΔREF Mode to be on or off.	DRF; DRO; DRO?
SELECT ΔREF MARKER	Calls menu M2, which lets you select the ΔREF Marker.	None
READOUT MARKER FUNCTIONS	Calls menu M9, which lets you select readout marker parameters.	None

*Menu M1, Set Markers*

MENU	DESCRIPTION	GPIB COMMAND
SELECT ΔREF MARKER		None
MARKER 1 XXX.XXXXXXXXXX GHz	Marker 1 only appears if it has been activated in menu M1. Placing the cursor on Marker 1 and pressing the Enter key here selects it as the ΔREF marker. The ΔREF marker is the one from which the other active markers are compared and their difference frequency measured and displayed in menu M3. The marker frequency may be set using the keypad or rotary knob.	DR1; DRX?
MARKER 3 XXX.XXXXXXXXXX GHz	Same as above, but for Marker 3. <i>This display is representative if Markers 1, 3, and 4 are selected. Markers 2, 5, and 6 would also show, if they had been selected.</i>	DR3; DRX?
MARKER 4 XXX.XXXXXXXXXXGHz	Same as above, but for Marker 4	DR4; DRX?
PRESS <ENTER> TO SELECT	Pressing the Enter key implements your menu selection.	None

*Menu M2, Select ΔREF Marker*



MENU	DESCRIPTION	GPIB COMMAND
SELECT READOUT MARKER		None
MARKER 1 XXX.XXXXXXXXXX GHz	Displays the frequency and S-Parameter value(s) of Marker 1 on all displayed graphs and Smith Charts. The frequency of Marker 1 also displays here. If Marker 1 was activated in menu M2 as the REF marker, REF appears as shown for Marker M5 below.	DR1; DRX?
MARKER 2 XXX.XXXXXXXXXX GHz	Same as above, but for Marker 2.	DR2; DRX?
MARKER 5 XXX.XXXXXXXXXX GHz	Same as above, but for Marker 5 <i>This display is representative if Markers 1, 2, and 5 are selected. Markers 3, 4, and 6 would also show, if they had been selected.</i>	DR5; DRX?
$\Delta$ REF MODE IS ON (OFF)	Indicates the status of the $\Delta$ REF mode.	DRO; DRO?
PRESS <ENTER> TO SELECT	Pressing the Enter key implements your menu selection.	None

*Menu M3, Select Readout Marker*

MENU	DESCRIPTION	GPIB COMMAND
C H 1 — S 1 1, USER	Selects channel for readout	None
+XXX.XXXX mm REF +XXX.XXX dB OFFSET +XXX.XX ° OFFSET	The constant offset for the channel is displayed.	None
MARKER X XXX.XXXXXXXXXX GHz XX.XXX dB XXX.XXX °	The selected marker—that is, the one to which the cursor points in menu M1—and its frequency, time, or distance display here. This could be any one of the six available markers: Marker 1 through Marker 6.	MR1; MR1? MK1; MK1? OM1
MARKER TO MAX	Causes the active marker to go to the frequency with the <i>greatest</i> S-Parameter value on the active channel.	MMX
MARKER TO MIN	Causes the selected marker to go to the frequency with the <i>smallest</i> S-Parameter value on the active channel.	MMN
2 XXX.XXXXXXXXXX GHz XX.XXX dB XXX.XXX °	Displays the frequency, magnitude, and phase of the active S-Parameter at marker 2, if the marker is enabled.	MR2; MR2? MK2; MK2? OM2
3 XXX.XXXXXXXXXX GHz XX.XXX dB XXX.XXX °	Displays the frequency, magnitude, and phase of the active S-Parameter at marker 3, if the marker is enabled.	MR3; MR3? MK3; MK3? OM3
4 XXX.XXXXXXXXXX GHz XX.XXX dB XXX.XXX °	Displays the frequency, magnitude, and phase of the active S-Parameter at marker 4, if the marker is enabled.	MR4; MR4? MK4; MK4? OM4
5 XXX.XXXXXXXXXX GHz XX.XXX dB XXX.XXX °	Displays the frequency, magnitude, and phase of the active S-Parameter at marker 5, if the marker is enabled.	MR5; MR5? MK5; MK5? OM5
6 XXX.XXXXXXXXXX GHz XX.XXX dB XXX.XXX °	Displays the frequency, magnitude, and phase of the active S-Parameter at marker 6, if the marker is enabled.	MR6; MR6? MK6; MK6? OM6
MARKER READOUT FUNCTIONS	Calls menu M9, which lets you select readout marker parameters.	None

Menu M4, Readout Marker

MENU	DESCRIPTION	GPIB COMMAND
C H 1 — S 1 1, USER		None
+XXX.XXXX mm REF +XXX.XXX dB OFFSET +XXX.XX ° OFFSET	The constant offset for the channel is displayed.	MK1? - MK6?
MARKER X XXX.XXXXXXXXXX GHz MARKER TO MAX MARKER TO MIN	The selected marker—that is, the one to which the cursor points in menu M1—and its frequency, time, or distance display here. This could be any one of the six available markers: Marker 1 through Marker 6.	
Δ(1 - 2) XXX.XXXXXXXXXX GHz XX.XXX dB XXX.XXX°	The marker numbers of the REF marker and the next lowest-numbered selected marker appear between the parentheses. This example assumes Marker 1 as the Ref marker and Marker 2 as the next lowest-numbered selected marker. The lines below display the difference frequency, (or time/distance ) and trace value(s) between these two markers on the active channel.	
Δ(1 - 3) XXX.XXXXXXXXXX GHz XX.XXX dB XXX.XXX°	Same as above, except Marker 3 is the next lowest-numbered selected marker.	
Δ(1 - 4) XXX.XXXXXXXXXX GHz XX.XXX dB XXX.XXX°	Same as above, except Marker 4 is the next lowest-numbered selected marker.	
Δ(1 - 5) XXX.XXXXXXXXXX GHz XX.XXX dB XXX.XXX°	Same as above, except Marker 5 is the next lowest-numbered selected marker.	
Δ(1 - 6) XXX.XXXXXXXXXX GHz XX.XXX dB XXX.XXX°	Same as above, except Marker 6 is the next lowest-numbered selected marker.	
MARKER READOUT FUNCTIONS	Calls menu M9, which lets you select readout marker parameters.	None

*Menu M5, Set ΔREF Marker Readout*

MENU	DESCRIPTION	GPIB COMMAND
MARKER X ALL DISPLAYED CHANNELS	Displays the active marker number. For each channel being displayed, the channel, S-Parameter, frequency, time, distance or point number, and the current readout value for the marker is shown (below). No marker information is provided for channels that are not displayed .	None
CH 1 — S11 XX.XXXXXXXXXX GHz –XXX.XXX dB –XXX.XX °	Displays the measured value for the active marker on all channels currently being displayed. You can set the marker on the active channel in this menu. The active channel is displayed in GREEN; when not active it is displayed in BLUE.	OAM1
CH 2 — S21	See above.	OAM2
CH 3 — S12 XX.XXXXXXXXXX GHz –XXX.XXX dB –XXX.XX °	See above.	OAM3
CH 4 — S22	See above.	OAM4
MARKER TO MAX	Causes the active marker to go to the frequency with the <i>greatest</i> S-Parameter value on the active channel.	MMX
MARKER TO MIN	Causes the selected marker to go to the frequency with the <i>smallest</i> S-Parameter value on the active channel.	MMN
MARKER READOUT FUNCTIONS	Calls menu M9, which lets you select readout marker parameters.	None
PRESS <ENTER> TO SELECT	Pressing the Enter key implements menu selection.	None

*Menu M6, Marker X All Displayed Channels*

MENU	DESCRIPTION	GPIB COMMAND
SEARCH	This menu provides control and readout for the marker search function. When this function is selected, the graph type for the active channel is automatically set to LOG MAGNITUDE (other graph types are not allowed), and taken out of time domain low pass or band pass display. Frequency with time gate display is allowed.	SRCH
VALUE -XXX.XXX dB	Target search value. A value from -999.999 to 999.999 dB may be entered.	SRCH
REFERENCE	These menu choices let you enter the reference value for the search. The reference may be: -Gaticule "0 dB" -Position of Delta Ref. Marker (Marker 1 is used as the Δ Ref Marker) -Maximum value in Passband (default selection). Marker 1 is used to indicate maximum.	None
MAXIMUM VALUE	Selects maximum value as the reference.	MMX
Δ REF MARKER	Selects Δ Ref Marker (Marker 1) as the reference.	DR1-DR6; DRX?
0 dB	Selects 0 dB as the reference.	MSR0; MSRX?
VALUE AT REFERENCE -XXX.XXX dB	Displays the difference between the reference value and 0 dB.	OM1
SEARCH LEFT	Goes to the next data point that is left (or right) of the search marker (Marker 2) and whose value is equal to VALUE plus the reference. If "TRACKING" is ON, Marker 2 will search both left and right, and go to the closest point whose value is equal to VALUE plus reference. If there is no such point, the message "VALUE NOT FOUND" is displayed in the data area. Otherwise the marker goes to that coordinate and the readout (under the search direction) is updated to reflect that frequency.	MKSL
SEARCH RIGHT		MKSR
XX.XXXXXXXXXX GHz		
SEARCH MRKR VALUES CH1: XX.XXX dB CH2: XX.XXX dB CH3: XX.XXX dB CH4: XX.XXX dB		None
TRACKING      ON (OFF)	When ON the active marker will change its frequency value after every sweep to maintain the user entered loss value. When OFF the marker stays at the same frequency and reads out the magnitude value at that frequency, except when a search is triggered.	
MARKER READOUT FUNCTIONS	Calls Menu M9, which lets you select readout marker parameters.	

*Menu M7, Search*

MENU	DESCRIPTION	GPIB COMMAND
FILTER PARAMETERS	Provides the readouts for the filter measurement functions, as well as some selections. When this function is selected, the graph type for the active channel is automatically set to LOG MAGNITUDE, and taken out of time domain low pass or band pass display. Frequency with time gate display is allowed.	None
CENTER FREQ XX.XXXXXXXXXX GHz	Displays the value of Marker 2. Marker 1 displays the reference value (maximum filter response, or its set value if delta ref).	FLTC
BANDWIDTH XXX.XXX dB Δ REF MARKER XX.XXXXXXXXXX GHz	Displays the difference between Markers 3 and 4.	FLTBW?
LOSS AT REF -XXX.XXX dB	Displays the difference between the reference value and 0 dB.	FLTL?
Q XX.XXX	Displays the Q value.  NOTE: "Q" and "SHAPE FACTOR" are not displayed if they are toggled OFF in menu M8A.	FLTQ?
SHAPE FACTOR X.XXX	Displays the Shape Factor value.	FLTS?
TRACKING      ON (OFF)	When ON the active marker will change its frequency value after every sweep to maintain the user entered loss value. When OFF the marker stays at the same frequency and reads out the magnitude value at that frequency, except when a search is triggered.	MKT1; MKT0; MKTX?
FILTER SETUP	Calls menu M8A, which lets you set filter parameters.	None
MARKER READOUT FUNCTIONS	Calls menu M9, which lets you select readout marker parameters.	None
PRESS <ENTER> TO SELECT OR TURN ON/OFF	Pressing the Enter key implements menu selection, or toggles selected option on or off.	None

*Menu M8, Filter Parameters*

MENU	DESCRIPTION	GPIB COMMAND
FILTER SETUP		None
BANDWIDTH LOSS VALUE XXX.XXX dB	A "loss" is a positive number. A value of 0 to 999.999 dB may be entered. The search value for bandwidth will be REF minus (-) LOSS. By default, the loss value is set to 3 dB.	BWLS; BWL3; BWLS?
REFERENCE	These menu choices let you enter the reference value for the search. The reference may be: -Graticule "0 dB". -Position of Delta Ref. Marker. (Marker 1 is used as the Δ Ref Marker). -Maximum value in Passband (default selection). Marker 1 is used to indicate maximum.	None
MAXIMUM VALUE	Selects maximum value as the reference.	MMX
Δ REF MARKER	Selects Δ Ref Marker (Marker 1) as the reference.	MMN
0 dB	Selects 0 dB as the reference.	MSR0; MSR?X?
SHAPE FACTOR		
HIGH XXX.XXX dB	Enter high and low values for the Shape Factor. The LOW entry must be less than the HIGH entry. A value of 0 to 999.999 dB may be entered. The defaults are +6 dB for the HIGH, and +60 dB for the LOW value.	MSFH; MSFH?
LOW XXX.XXX dB		MSFL; MSFL?
READOUTS		None
Q ON (OFF)	Toggles Q on or off. NOTE: "Q" is not displayed in menu M8, if it is toggled OFF.	DSQ1; DSQ0; DSQX?
SHAPE FACTOR ON (OFF)	Toggles the Shape Factor on or off. NOTE: "SHAPE FACTOR" is not displayed in menu M8, if it is toggled OFF.	DSF1; DSF0; DSFX?
PREVIOUS MENU	Returns to the M8 menu.	

*Menu M8A, Filter Setup*

MENU	DESCRIPTION	GPIB COMMAND
MARKER READOUT FUNCTIONS		None
MARKERS ON ACTIVE CHANNEL	Calls menu M3 directly — or causes it to be displayed when the Readout Marker key is pressed — if there is no active marker. Or to it calls or causes menu M4 to be displayed if there is an active marker. If in delta reference mod, menu M5 is displayed.	None
ACTIVE MARKERS ON ALL CHANNELS	Calls menu M6 directly —or causes it to be displayed when the Readout Marker key is pressed.	None
SEARCH	Calls menu M7 directly —or causes it to be displayed when the Readout Marker key is pressed.	None
FILTER PARAMETERS	Calls menu M8 directly —or causes it to be displayed when the Readout Marker key is pressed.	None
MARKER MODE		None
CONTINUOUS	Marker values are interpolated between data points, Interpolated markers are allowed only when the horizontal axis of the display is FREQUENCY. Interpolated markers are not allowed in CW, Time Domain, or Power Sweep. If a channel has been set to interpolated markers and the sweep is changed to CW or Power Sweep, the markers will automatically revert to normal mode (DISCRETE). Time Domain will ignore CONTINUOUS mode. Interpolated markers are allowed in any graph type, as long as the sweep is by frequency.	MKRC; MKRX?
DISCRETE	Markers are displayed only at actual measured data point values.	MKRD; MKRX?
SET MARKERS	Calls menu M1, which lets you set marker parameters.	None
PRESS <ENTER> TO SELECT	Pressing the Enter key implements menu selection.	None

*Menu M9, Marker Readout Functions*



MENU	DESCRIPTION	GPIB COMMAND
MILLIMETER WAVE TEST SET BAND		None
WR-22 (33 - 50 GHz)	Selects WR-22 (33 - 50 GHz) waveguide for use with millimeter wave system.	Q22
WR-15 (50 - 75 GHz)	Selects WR-15 (50 - 75 GHz) waveguide for use with millimeter wave system.	V15
WR-12 (60 - 90 GHz)	Selects WR-12 (60 - 90 GHz) waveguide for use with millimeter wave system.	E12
WR-12 EXTENDED (56 - 94 GHz)	Selects WR-12 Extended band (56 - 94 GHz) waveguide for use with millimeter wave system.	E12E
WR-10 (75 - 110 GHz)	Selects WR-10 (75 - 110 GHz) waveguide for use with millimeter wave system.	W10
WR-10 EXTENDED (65 - 110 GHz)	Selects WR-10 Extended band (65 - 110 GHz) waveguide for use with millimeter wave system.	W10E
PRESS <ENTER> TO SELECT	Pressing the Enter key implements your menu selection and takes you to menu MMW2.	None
PRESS <CLEAR> TO ABORT	Pressing the Clear key aborts your millimeter wave system selection and calls menu OST1.	None

*Menu MMW1, Millimeter Wave Test Set Band*

MENU	DESCRIPTION	GPIB COMMAND
MILLIMETER WAVE TEST SET MODULES		None
PORT 1 MODULE 3740/3741/None	Switch selection for Port 1 Module.	P1MMN; P1MMR; P1MMNT; P1MMX?
PORT 2 MODULE 3740/3741/None	Switch selection for Port 2 Module.	P2MMN; P2MMR; P2MMNT; P2MMX?
ACCEPT CONFIG	Accepts the selected configuration and calls menu MMW3.	None
PRESS <ENTER> TO SELECT OR SWITCH	Pressing the Enter key implements your menu selection,	None
PRESS <CLEAR> TO ABORT	Pressing the Clear key aborts your millimeter wave system selection and calls menu OST1.	None

*Menu MMW2, Millimeter Wave Test Set Modules*

MENU	DESCRIPTION	GPIB COMMAND
MILLIMETER WAVE TEST SET		None
mm WAVE BAND: XXXXXXXXXXXX	Provides information for selections made in menu MMW2 (previous menu).	None
PORT 1 MODULE XXXXXXXXXXXX		P1MMX?
PORT 2 MODULE XXXXXXXXXXXX  WARNING:  CONTINUING MAY INVALIDATE CURRENT SETUP AND CALIBRATION		P2MMX?
PRESS <ENTER> TO SELECT	Pressing the Enter key implements your millimeter wave selection and calls menu SU1 or SU3.	None
PRESS <CLEAR> TO ABORT	Pressing the Clear key aborts your millimeter wave system selection and calls menu OST1.	None

*Menu MMW3, Millimeter Wave Test Set*

MENU	DESCRIPTION	GPIB COMMAND
mm WAVE BAND		None
BAND START FREQ XXXXXXXXXXXX	Displays the start frequency of the millimeter wave band.	
BAND STOP FREQ XXXXXXXXXXXX	Displays the stopfrequency of the millimeter wave band.	
EQUATION TO EDIT		
SOURCE 1	Selects source 1 frequency equation for change.	
SOURCE 2	Selects source 2 frequency equation for change.	
RECEIVER	Selects receiver frequency equation for change.	
EQUATION SUMMARY		
C.W. ON/OFF	Toggles frequency term (F) in equation ON or OFF.	
MULTIPLIER XXX	Enables changing multiplier term of frequency equation via key pad or rotary knob.	
DIVISOR XXX	Enables changing divisor term frequency equation via key pad or rotary knob.	
OFFSET FREQ XXXXXXXXXX	Enables changing offset frequency term frequency equation via key pad or rotary knob.	
DEFAULT EQUATIONS	Pressing the Enter key implements your menu selection.	None
ACCEPT EQUATIONS	Pressing the Clear key aborts your millimeter wave selection and calls menu SU1 or SU3.	None

*Menu MMW4, mm Wave Band*

- MILLIMETER WAVE BAND DEFINITION SUMMARY -

BAND FREQUENCY RANGE

BAND START FBAND STOP F  
XXX.XXXXXX XXXXXX.XXXXXX XXX

FREQUENCY = (MULTIPLIER/DIVISOR) \* F + OFFSET FREQ)

SOURCE 1 = (1/ 6) \* (F - 0.270000 GHz)

SOURCE 2 = (1/ 8) \* (F+ 0.000000 GHz)

RECEIVER = (1/ 1) \* (0.270000 GHz C.W.)

- NOTES -

1. SELECT <DEFAULT EQUATIONS> TO OVERWRITE DEFINITION WITH VALUES SUITABLE FOR THE MILLIMETER WAVE BAND.
2. SELECT <ACCEPT EQUATIONS> TO CONFIRM ANY CHANGES.
3. PERFORMANCE SPECIFICATIONS ARE VALID ONLY WHILE USING THE DEFAULT EQUATIONS OVER THE DEFAULT BAND FREQUENCY RANGE.
4. DEVIATING FROM THE DEFAULT MAY CAUSE LOCK FAILURES.  
PRESS <ENTER> TO SELECT, PRESS <CLEAR> TO ABORT

Menu EXT\_MMW4

MENU	DESCRIPTION	GPIB COMMAND
MERGE CAL FILES		None
CAL FILES MUST EXIST IN THE CURRENT DIRECTORY		None
MERGE CAL FILES	Calls menu MRG2, then menu MRG3 to select the calibration files.	LDMCF, IMCF
PRESS <ENTER> TO SELECT	Pressing the Enter key implements your menu selection.	None

*Menu MRG1, Merge Calibration Menu*

<p>- MERGE CALIBRATION FILES -</p> <p>RF CALIBRATIONS USING DIFFERENT METHODS AND AT DIFFERENT FREQUENCIES CAN BE MERGED USING CAL FILES.</p> <p>- REQUIREMENTS -</p> <ul style="list-style-type: none"> <li>- PERFORM TWO RF CALIBRATIONS USING THE SAME CAL TYPE AND STORE EACH CAL AND FRONT PANEL SETUP TO DISK (e.g. CALFILE1.CAL AND CALFILE2.CAL).</li> <li>- CAL FILES MUST BE PLACED IN THE CURRENT DIRECTOY OF THE HARD OR FLOPPY DISK.</li> <li>- THE COMBINED FREQ LIST CANNOT EXCEED 1601 POINTS.</li> </ul> <p>- INSTRUCTIONS -</p> <ol style="list-style-type: none"> <li>1. SELECT &lt;MERGE CAL FILES&gt; TO READ THE FIRST AND SECOND CAL FILES FROM DISK (E.G. CALFILE1.CAL AND CALFILE2.CAL, REPECTIVELY).</li> <li>2. THE FREQUENCY LISTS AND MATCHING CORRECTIONTERMS ARE COMBINED. FOR FREQUENCIES WHICH COINCIDE, THE TERMS FROM THE FIRST CAL FILE ARE USED. THE FRONT PANEL SETUP FROM THE FIRST CAL FILE IS USED, EXCEPT THAT THE START AND STOP FREQS ARE ADJUSTED TO INCLUDETHE ENTIRE RANGE. THE DATA POINT TYPE IS CHANGED TO MATCH THE RESULTING FREQUENCY LIST (I.E. NORMAL, N-DISCRETE, TIME DOMAIN HARMINIC). IF DESIRED, SAVE RESULTS.</li> </ol>
---

*Menu EXT\_MRG1, Merge Calibration Menu*

MENU	DESCRIPTION	GPIB COMMAND
MERGE CAL FILES		LDMCF, IMCF
READ CAL FILE 1 FROM HARD DISK	Calls menu DSK2 to read the CAL file 1 in the current directory of the hard disk. Completion of the file read takes the user to menu MRG3.	None
READ CAL FILE 1 FROM FLOPPY DISK	Calls menu DSK2 to read the CAL file 1 in the current directory of the floppy disk. Completion of the file read takes the user to menu MRG3.	None
PRESS <ENTER> TO SELECT	Pressing the Enter key implements your menu selection.	None
PRESS <CLEAR> TO ABORT	Pressing the Clear key aborts this menu selection and returns to menu MRG1.	None

*Menu MRG2, Merge Calibration Menu*

MENU	DESCRIPTION	GPIB COMMAND
MERGE CAL FILES		LDMCF, IMCF
READ CAL FILE 2 FROM HARD DISK	Calls menu DSK2 to read the CAL file 2 in the current directory of the hard disk. Completion of the file read starts the merge of the calibration terms. Finishing the merge recalls the front panel setup of the CAL file 1 and displays the setup menu.	None
READ CAL FILE 2 FROM FLOPPY DISK	Calls menu DSK2 to read the CAL file 2 in the current directory of the floppy disk. Completion of the file read starts the merge of the calibration terms. Finishing the merge recalls the front panel setup of the CAL file 1 and displays the setup menu.	None
PRESS <ENTER> TO SELECT	Pressing the Enter key implements your menu selection.	None
PRESS <CLEAR> TO ABORT	Pressing the Clear key aborts this menu selection and returns to menu MRG1.	None

*Menu MRG3, Merge Calibration Menu*

MENU	DESCRIPTION	GPIB COMMAND
TRACE MEMORY FUNCTIONS		None
VIEW DATA	Displays measured data; that is, the data presently being taken.	DAT; DAT?
VIEW MEMORY	Displays stored data; that is, data that was previously taken and stored in memory.	MEM
VIEW DATA AND MEMORY	Displays measured data superimposed over stored data.	DTM
VIEW DATA (/) MEMORY	Displays measured data combined with stored data using selected math.	DNM
SELECT TRACE MATH	Calls menu NO2 for selection of the type of math operation to be performed.	None
STORE DATA TO MEMORY (STORED) (NOT STORED)	Stores the measured data to internal memory.	STD
DISK OPERATIONS	Brings up menu NO3, which allows data to be stored to or recalled from the disk.	None
PRESS <ENTER> TO SELECT	Pressing the Enter key implements your menu selection.	None

*Menu NO1, Trace Memory Functions*



MENU	DESCRIPTION	GPIB COMMAND
SELECT TRACE MATH		None
ADD (+ )	Selects DATA + MEMORY as the math function.	ADD
SUBTRACT (-)	Selects DATA - MEMORY as the math function.	MIN
MULTIPLY (*)	Selects DATA X MEMORY as the math function.	MUL
DIVIDE (/)	Selects DATA MEMORY as the math function.	DIV
PRESS <ENTER> TO SELECT	Pressing the Enter key implements your menu selection. The menu returns to the NO1 menu.	None

*Menu NO2, Select Trace Math*

MENU	DESCRIPTION	GPIB COMMAND
TRACE MEMORY DISK OPERATIONS		None
CHANNEL X	Indicates the channel to be used (active channel).	CH1-CH4; CHX?
SAVE MEMORY TO HARD DISK	Calls menu DSK3, which lets you save memory to the hard disk.	None
SAVE MEMORY TO FLOPPY DISK	Calls menu DSK3, which lets you save memory to the floppy disk.	None
RECALL MEMORY FROM HARD DISK	Calls menu DSK2, which lets you recall memory from the hard disk.	None
RECALL MEMORY FROM FLOPPY DISK	Calls menu DSK2, which lets you recall memory from the floppy disk.	None
PRESS <ENTER> TO SELECT	Pressing the Enter key implements your menu selection.	None

*Menu NO3, Trace Memory Disk Functions*

MENU	DESCRIPTION	GPIB COMMAND
NxN SOLUTION		None
LOCATION OF CURRENT DIRECTORY HARD DISK/FLOPPY	Select where current S2P file is located: hard disk or floppy disk.	None
DEVICE PAIR (1+2) PAIR_1_2.S2P	Calls menu DSK2, which lets users select the file to read into memory.	None
DEVICE PAIR (1+3) PAIR_1_3.S2P	Calls menu DSK2, which lets users select the file to read into memory.	None
DEVICE 1 LENGTH XXX.XXX mm XXX.XXX ps		NXNL1; NXNL1?
DEVICE 2 LENGTH XXX.XXX mm XXX.XXX ps		NXNL2; NXNL2?
DEVICE 3 LENGTH XXX.XXX mm XXX.XXX ps		NXNL3; NXNL3?
SOLVE DEVICE 1	Finds a solution for applicable device and calls menu DSK3. DSK3 lets users override or create S2P file.	INXNO1; INXNSV1; LDNXNO1; LDNXNSV1
SOLVE DEVICE 2		INXNO2; INXNSV2; LDNXNO2; LDNXNSV2
SOLVE DEVICE 3		INXNO3; INXNSV3; LDNXNO3; LDNXNSV3

*Menu NXN, NxN Solution*

- NxN SOLUTION USING S2P FILES -

MEASUREMENTS OF THREE DEVICE PAIRINGS CAN BE COMBINED TO DEDUCE THE BEHAVIOR OF EACH INDIVIDUAL DEVICE. PROVIDING THREE S2P FILES CONTAINING THE RESPONSE MEASUREMENTS OF THE DEVICE PAIRS, THE USER CAN SOLVE FOR A DEVICE'S RESPONSE CHARACTERISTICS (S2P FILE).

- REQUIREMENTS -

- THE CURRENT DIRECTORY OF THE SELECTED DISK IS USED FOR THE INPUT AND OUTPUT S2P CHARACTERIZATION FILES.
- THE CHARACTERIZATION OF THE DEVICE PAIRS SHOULD BE IN 3 FILES USING THE S2P FORMAT (e.g. PAIR 1 2.S2P, PAIR 1 3.S2P, AND PAIR 2 3.S2P) .USE AS MANY POINTS AS POSSIBLE TO IMPROVE INTERPOLATION ACCURACY. MAKE SURE THEIR FREQ RANGES COINCIDE.
- IF THE DEVICE PAIRS TRANSLATE FREQUENCY (MIXERS), DEVICE 2 MUST BE RECIPROCAL. ALSO, DE-EMBED ANY FILTER AND I.F. INTERCONNECT NETWORK OR THRU LINES BEFORE CAPTURING THE DEVICE PAIRS' S2P FILES.
- IF CONCERNED WITH PHASE WRAPPING, ESTIMATE THE LENGTH (DELAY) FOR EACH OF THE DEVICES. IF NOT, USE ZERO.

.INSTRUCTIONS .

1. SELECT DISK WHERE THE CURRENT DIRECTORY IS LOCATED.
2. SELECT THE FILENAMES OF THE INPUT DEVICE PAIRS.
3. INPUT THE ESTIMATED LENGTH (DELAY) FOR EACH DEVICE.
4. SOLVE FOR THE DESIRED DEVICE, SAVING AS AN S2P FILE.

*Menu EXT\_NXN, NxN Solution*

MENU	DESCRIPTION	GPIB COMMAND
MULTIPLE SOURCE CONTROL		None
DEFINE BANDS	Calls menu OM1, which lets you define a frequency band.	None
SOURCE CONFIG	Calls menu SC, which lets you configure the frequency source.	None
MULTIPLE SOURCE MODE		None
OFF	Turns multiple source operating mode off placing 37XXXD VNA in normal operating mode.	MS0
DEFINE		None
ON	Sets multiple source mode to ON.	MS1
MORE	Calls menu OM1A, which lets you select source-lock polarity.	None
PRESS <ENTER> TO SELECT	Pressing the Enter key implements your menu selection.	None

*Menu OM1, Multiple Source Control Menu*

MENU	DESCRIPTION	GPIB COMMAND
SOURCE LOCK POLARITY		None
NORMAL REVERSE	Calls menu OM1, which lets you define a frequency band.	None
SELECT <REVERSE> SOURCE LOCK POLARITY IF		None
THE DUT CONTAINS MULTI-CONVERSION STAGES, AND		None
THE PHASE OF THE FINAL OUTPUT I.F. IS OPPOSITE OF NORMAL		None
NORMAL POLARITY IS DEFINED BY THE SOURCE 1 AND 2 EQUATIONS		None
IF SOURCE 1 FREQ IS GREATER THAN SOURCE 2 FREQ THEN THE I.F. IS ASSUMED TO BE POSITIVE POLARITY AND VICE VERSA		None

*Menu OM1A, Source Lock Polarity Menu*

MENU	DESCRIPTION	GPIB COMMAND
DEFINE BANDS		None
BAND 1	Displays the band number being defined.	BD1-BD5
DISPLAYED FREQ RANGE		None
BAND START FREQ XX.XXXXXX GHz	Displays the start frequency for the band.	BST; BST?
BAND STOP FREQ XX.XXXXXX GHz	Displays the stop frequency for the band.	BSP; BSP?
BAND FUNCTIONS		None
EDIT SYSTEM EQUATIONS	Calls menu OM3, which lets you edit system equations.	None
STORE BAND 1 BANDS STORED: ( 1 2 3 4 5 )	Indicates the band that will be stored and, within the parenthesis, indicates the bands that have been stored.	SVBMM
CLEAR ALL DEFINITIONS	Clears all the band definitions that may have been previously stored.	CLB; CLBMM
SET MULTIPLE SOURCE STATE	Selects Multiple Source Control menu OM0.	None
PRESS <ENTER> TO SELECT	Pressing the Enter key implements your menu selection.	None

*Menu OM2, Define Bands Menu*

MENU	DESCRIPTION	GPIB COMMAND
EDIT SYSTEM EQUATIONS		None
EQUATION TO EDIT		None
SOURCE 1	Selects source 1 frequency equation for change.	ED1
SOURCE 2	Selects source 2 frequency equation for change.	ED2
RECEIVER	Selects receiver frequency equation for change.	EDR
EQUATION SUMMARY		None
C.W. ON (OFF)	Toggles frequency term (F) in equation ON or OFF.	ESW; ECW; EXW?
MULTIPLIER XX	Enables changing multiplier term of frequency equation via key pad or rotary knob.	EML
DIVISOR XX	Enables changing divisor term frequency equation via key pad or rotary knob.	EDV
OFFSET FREQ XXX.XXXXXXXXXX GHz	Enables changing offset frequency term frequency equation via key pad or rotary knob.	EOS; EOS?
PREVIOUS MENU	Recalls menu OM1.	None
PRESS <ENTER> TO SELECT	Pressing the Enter key implements your menu selection.	

*Menu OM3, Edit System Equations*

MENU	DESCRIPTION	GPIB COMMAND
OPTIONS		None
TRIGGERS	Calls menu TRIG, which lets you define trigger source.	None
REAR PANEL OUTPUT	Calls menu ORP1, which lets you select an output for the rear panel AUX I/O connector.	None
DIAGNOSTICS	Calls menu DG1, which lets you implement system diagnostics.	None
MULTIPLE SOURCE CONTROL	Calls menu OM1, which lets you use and define multiple sources.	None
BROADBAND DEFINITION	If the Broadband Test Is selected, this option appears in place of Multiple Source Control. It calls menu BB4.	BDMM
MILLIMETER WAVE BAND DEFINITION	Calls menu MMW4.	None
RECEIVER MODE	Calls menu RCV1, which gives you Receiver Mode control options.	None
SOURCE CONFIG	Calls menu SC, which lets you configure the frequency source.	None
RF ON/OFF DURING RETRACE	Turns RF during retrace and switch points ON or OFF. The user must keep the sweep range small, preferably below 2 GHz. Avoid including any switch points where RF would be blanked for delays due to hardware settling.	RT0; RT1; RTX?
PRESS <ENTER> TO SELECT	Pressing the Enter key implements your menu selection.	None

*Menu OPTNS, Select Options*



MENU	DESCRIPTION	GPIB COMMAND
REAR PANEL OUTPUT CONTROL		None
OUTPUT      ON (OFF)	Turns the rear panel ANALOG OUT output on or off.	RV1; RV0; RV1?
SELECT MODE XXXXXXXXXX	Calls menu ORP2, which lets you select an output mode.	None
HORIZONTAL OR PHASE LOCK SCALING		None
START/LOCK    a1 X.XXXX    V	Lets you enter a voltage for the start/lock frequency. Value will be a frequency start voltage if SELECT MODE choice is HORIZONTAL. It will be a phase-lock voltage if SELECT MODE choice is PHASELOCK.	VST; VST?
STOP/LOCK     a2 X.XXXX    V	Lets you enter a voltage for the start/lock frequency. Value will be a frequency stop voltage if SELECT MODE choice is HORIZONTAL. It will be a phase-lock voltage if SELECT MODE choice is PHASELOCK.	VSP; VSP?
VERTICAL SCALING		None
RESOLUTION 1.000 V/DIV	Shows fixed value for VERTICAL mode.	SCL; SCL?; SCL2; SCL2?
REFERENCE VALUE 0.000 V/DIV	Shows fixed value for VERTICAL mode.	OFF; OFF?; OFF2; OFF2?
PRESS <ENTER> TO SELECT OR TURN ON/OFF	Pressing the Enter key implements your menu selection.	None

*Menu ORP1, Rear Panel Output Control*

MENU	DESCRIPTION	GPIB COMMAND
SELECT MODE FOR OUTPUT		None
HORIZONTAL	Pressing Enter key selects horizontal drive for external chart recorder connected to ANALOG OUT connector.	RVH; RVX?
VERTICAL	Pressing Enter key selects vertical drive for external chart recorder connected to ANALOG OUT connector.	RVV; RVX?
PHASE LOCK	Pressing Enter key selects phase-lock for external chart recorder connected to ANALOG OUT connector.	RVL; RVX?
PRESS <ENTER> TO SELECT	Pressing the Enter key implements your menu selection.	None

*Menu ORP2, Select Output Mode*

MENU	DESCRIPTION	GPIB COMMAND
TEST SET CONFIGURATION		None
INTERNAL	Calls menu OTS2.	SELINT; SELXX?
S-PARAMETER	Calls menu OTS3.	SELSP; SELXX?
MILLIMETER WAVE	Calls menu MMW1.	SELMW; SELXX?
BROADBAND	Calls menu BB2.	SELBB; SELXX?
PRESS <ENTER> TO SELECT	Pressing the Enter key implements your menu selection.	

*Menu OTS1, Test Set Configuration*

MENU	DESCRIPTION	GPIB COMMAND
INTERNAL TEST SET  WARNING:  CONTINUING WILL INVALIDATE CURRENT SETUP AND CALIBRATION		None
PRESS <ENTER> TO SELECT	Pressing the Enter key implements internal test set configuration.	None
PRESS <CLEAR> TO ABORT	Pressing the Clear key aborts internal test set configuration.	None

*Menu OTS2, Warning*

MENU	DESCRIPTION	GPIB COMMAND
SELECT POLAR CHART MODE		None
MAGNITUDE, PHASE	Selects Polar Chart Display to show magnitude and phase for the full frequency range—from start frequency to stop frequency.	PCP
MAGNITUDE, SWP POSITION	Selects Polar Chart Display to show magnitude information only for the phase data that falls between the start and stop angles selected below.	PCS
SET SWEEP POSITION BOUNDARIES	Sets the start and stop angles for the data display.	AST; ASP
START ANGLE X.XX°		AST; AST?
STOP ANGLE X.XX°		ASP; ASP?
PRESS <ENTER> TO SELECT	Pressing the Enter key implements your menu selection.	None

*Menu PC1, Select Polar Chart Mode*

MENU	DESCRIPTION	GPIB COMMAND
PARAMETER DEFINITION		None
S21/USER 1	Lets you choose between displaying a pre-defined S-Parameter or a user-defined parameter.	USR1-USR4
RATIO b2 / a1	Displays the parameters chosen as numerator and denominator.	DA1; DA2; DB1; DB2; DR1
PHASE LOCK a1	Displays the phase-lock parameter.	NA1; NA2; NB1; NB2; NU1
USER LABEL: MY S11	Displays the name of the user-defined parameter.	USL; USL?
CHANGE RATIO	Calls menu PD2, which lets you change the ratio.	None
CHANGE PHASE LOCK		None
CHANGE LABEL	Calls menu GP5, which lets you name your newly defined parameter. The label appears at the top of the graph-type display and under the word "LABEL" in the menu.	None
PREVIOUS MENU	Returns to the previous menu, SP.	None
PRESS <ENTER> TO SELECT OR SWITCH	Pressing the ENTER key implements your menu selection.	None

*Menu PD1, Parameter Definition 1*

MENU	DESCRIPTION	GPIB COMMAND
PARAMETER RATIO		None
NUMERATOR		None
a1	Selects a1 as the numerator.	NA1
a2	Selects a2 as the numerator.	NA2
b1	Selects b1 as the numerator.	NB1
b2	Selects b2 as the numerator.	NB2
1 (UNITY)	Selects the numerator to be 1 (unity).	NU1
DENOMINATOR		None
a1	Selects a1 as the demoniator.	DA1
a2	Selects a2 as the demoniator.	DA2
b1	Selects b1 as the demoniator.	DB1
b2	Selects b2 as the demoniator.	DB2
1 (UNITY)	Selects the numerator to be 1 (unity).	DE1
PREVIOUS MENU	Returns you to menu PD1.	None
PRESS <ENTER> TO SELECT	Pressing the ENTER key implements your menu selection.	None

*Menu PD2, Parameter Ratio*

MENU	DESCRIPTION	GPIB COMMAND
PARAMETER DEFINITION		None
PHASE LOCK		None
a1 (Ra)	Selects a1.	None
a2 (Rb)	Selects a2.	None
PREVIOUS MENU	Returns you to menu PD1.	None
PRESS <ENTER> TO SELECT	Pressing the ENTER key implements your menu selection.	None

*Menu PD3, Parameter Definition 2*

MENU	DESCRIPTION	GPIB COMMAND
PLOT OPTIONS		None
FULL PLOT	The plotter will plot everything displayed on the screen (data traces, graticule, menu text) when START PRINT is pressed.	PFS
OPTIONS TO PLOT		None
HEADER ON (OFF)	The plot will include an information header if this option is on and START PRINT is pressed.	PLH; PLD
MENU ON (OFF)	The plot will include the menu text if this option is on and START PRINT is pressed.	PMN
LIMITS ON (OFF)	The plot will include any limit lines if this option is on and START PRINT is pressed.	PLM; PLD
GRATICULE ON (OFF)	The plot will include the graticule and annotation if this option is on and START PRINT is pressed. The plotter plots the graticule.	PGT; PLD
DATA TRACE(S) ON(OFF) AND MARKERS	The plot will include the data and any marker that are present if this option is on and START PRINT is pressed. The plotter plots the graticule.	PLT; PLD
PLOT FORMAT		None
PLOT SIZE	Calls menu PL2, which lets you select the size and location of the plot.	None
PEN COLORS	Calls menu PL3, which lets you select pen colors for the various elements of the plot: graticule, data traces, menu text and header. Also lets you select the relative pen speed.	None
PLOT ORIENTATION PORTRAIT LANDSCAPE	Select the orientation for your plot, either portrait or landscape.	PORT; PLO? LAND; PLO?
PRESS <ENTER> TO SELECT OR TURN ON/OFF	Pressing the Enter key implements your menu selection.	None

*Menu PL1, Plot Options*



MENU	DESCRIPTION	GPIB COMMAND
PLOT SIZE		None
FULL SIZE	Selects a full size (page) plot.	PFL
–QUARTER SIZE PLOTS–		None
UPPER LEFT	Selects a quarter-size plot, upper-left quadrant.	PTL
UPPER RIGHT	Selects a quarter-size plot, upper-right quadrant.	PTR
LOWER LEFT	Selects a quarter-size plot, lower-left quadrant.	PBL
LOWER RIGHT	Selects a quarter-size plot, lower-right quadrant.	PBR
PRESS <ENTER> TO SELECT	Pressing the Enter key implements your menu selection.	None

*Menu PL2, Select Plot Size*

MENU	DESCRIPTION	GPIB COMMAND
SELECT PEN COLORS		None
DATA PEN n	Selects the color in which the data will be plotted. The number of the pen displays where the "n" is shown.	DPN
DATA TRACE OVERLAY PEN n	Selects the color in which the 2nd trace in a dual trace overlay plot will be plotted. The number of the pen displays where the "n" is shown.	TPN
GRATICULE PEN n	Selects the color in which the graticule will be plotted. The number of the pen displays where the "n" is shown.	GPN; GPN?
MARKERS AND LIMITS PEN n	Selects the color in which the markers and limits will be plotted. The number of the pen displays where the "n" is shown.	MPN; MPN?
HEADER PEN n	Selects the color in which the header information will be plotted. The number of the pen displays where the "n" is shown.	HPN; HPN?
PEN SPEED 100 PERCENT OF MAXIMUM	Selects the pen's speed as a percentage of the plotter's maximum speed. (Used to optimize plots on transparencies or with worn pens.)	SPD; SPD?
PREVIOUS MENU	Recalls menu PL1.	None
PRESS <ENTER> TO SELECT	Pressing the Enter key implements your menu selection.	None

*Menu PL3, Select Pen Colors*

MENU	DESCRIPTION	GPIB COMMAND
HARD COPY		None
OUTPUT DEVICE	Allows hard copy output to be directed to the HDD or floppy, in addition to the printer and plotter. In addition to text (*.txt), S2P (*.s2p), and tabular (*.dat) files, bitmaps (*.bmp) and HPGL (*.hgl) files are offered to satisfy desktop publishing requirements. Specifically, color bitmaps and graphic language files can be imported into Windows applications, such as Cap3700.	None
PRINTER	Selects the printer as your output device.	None
PLOTTER	Selects the plotter as your output device.	None
DISK FILE	Selects a disk file as your output device.	None
SETUP & OPERATIONS		None
SETUP HEADERS	Calls menu PM2, which lets you define the output header information.	None
DISK OPERATIONS	Calls menu PM4, which lets you store/recall tabular data to/from disk.	None
OUTPUT OPTIONS		None
PRINT OPTIONS	Calls menu PM5.	None
PLOT OPTIONS	Calls menu PL1.	None
DISK FILE OPTIONS	Calls menu PM4A.	None
PRESS <ENTER> TO SELECT	Pressing the ENTER key implements your menu selection. The menu remains on the screen until another menu is selected for display or until the CLEAR/RET LOC key is pressed.	None

*Menu PM1, Select Data Output Type*

MENU	DESCRIPTION	GPIB COMMAND
DATA OUTPUT HEADERS		None
MODEL ON (OFF) XXXXXXXXXXXX	Selecting <1> displays menu GP5, which lets you select the letters and/or numbers in your model identifier.	LMS; LMS?
DEVICE ID ON (OFF) XXXXXXXXXXXX	Selecting <1> displays menu GP5, which lets you select the letters and/or numbers in your Device I.D. identifier.	LID; LID?
OPERATOR ON (OFF) XXXXXXXXXXXX	Selecting <1> displays menu GP5, which lets you select the letters identifying the operator.	LNМ; LNМ?
COMMENT ON (OFF) XXXXXXXXXXXX	Selecting <1> displays menu GP5, which lets you enter a comment.	LOC; LOC?
DATE ON (OFF)	Displays system date and time. Can be set in menu U6.	LDT1; LDT0
SETUP LOGO	Selecting <1> displays menu PM2A which lets you select any of three logo options.	None
PRESS <ENTER> TO TURN ON/OFF PRESS < 1 > TO CHANGE	Pressing the Enter key selects between menu selections. Pressing the CLEAR/RET LOC key lets you change the between ON and OFF states.  Pressing <1> lets you enter the desired label in menu GP5.	None

*Menu PM2, Data Output Headers*

MENU	DESCRIPTION	GPIB COMMAND
LOGO SETUP	Lets you turn off the Anritsu logo and select a user-define logo.	None
LOGO ON (OFF)	Turns the logo on and off.	LOGO1; LOGO0; LOGOX?
LOGO TYPE	Lets you define the logo type.	None
STANDARD	Causes the standard logo to be displayed.	LOGOS
USER LOGO	Lets users display their own log.	LOGOU
INSTALL USER LOGO FROM FLOPPY DISK		None
FOR PRINTER	Lets you define logo for printing.	None
FOR PLOTTER	Lets you define logo for plotting.	None
PREVIOUS MENU	Returns to previous menu.	None
PRESS <ENTER> TO SELECT	Pressing the Enter key selects between menu selections.	None

*Menu PM2A, Data Output Headers*

MENU	DESCRIPTION	GPIB COMMAND
TABULAR PRINTER OUTPUT FORMAT		None
MARKER DATA ON (OFF)	Provides for printing marker data.	PMK; PMT
SWEEP DATA ON (OFF)	Provides for printing sweep data. If you choose to print the sweep data, you can then choose how many points of the total sweep to print.	PTB; PMT
HEADER AND PAGE BREAKS ON (OFF)	Provides for printing header and page-break data.	HD0; HD1; HDX?
PRINT DENSITY		None
XXX PRINT PT(S) OUTPUT PRINTS 1 POINT EVERY XXX POINT(S)	Outputs one point every X points. Use the rotary knob to select total number of points to output. Skipping points will reduce the total number of printed points.	PT0-PT9
PREVIOUS MENU	Returns to menu PM5.	None
PRESS <ENTER> TO SELECT OR TURN ON/OFF	Pressing the Enter key selects between menu selections. Pressing the CLEAR/RET LOC key lets you change the between ON and OFF states.	None
TURN KNOB TO CHANGE NUMBER OF POINTS		None

*Menu PM3, Tabular Printer Output Format*

MENU	DESCRIPTION	GPIB COMMAND
GRAPHICAL PRINTER OUTPUT FORMAT		None
HEADER ON (OFF)	Provides for printing header data.	HD1; HD0; HDX?
SCREEN AREA TO OUTPUT		None
FULL SCREEN	Prints the full-screen data, including the menus.	PFS
GRAPH ONLY	Prints only the graph or Smith chart.	PGR
BITMAP FILE OUTPUT OPTIONS		None
TRUE COLOR	Configures the bitmap disk-file format as true color.	BMPT
COLOR ON WHITE BACKGROUND	Configures the bitmap disk-file format to be color on a white background.	BMPC
BLACK ON WHITE BACKGROUND	Configures the bitmap disk-file format to be black on a white background.	BMPB
PREVIOUS MENU	Returns to menu PM5.	None
PRESS <ENTER> TO SELECT OR TURN ON/OFF	Pressing the Enter key selects between menu selections. Pressing the <ENTER> key lets you change the between ON and OFF states.	None

*Menu PM3A, Graphical Printer Output Format*

MENU	DESCRIPTION	GPIB COMMAND
OUTPUT DISK OPERATIONS		None
TABULAR DATA FROM HARD DISK TO PRINTER	Calls DSK2 for selection of a measurement data file to be output to the printer.	None
TABULAR DATA FROM FLOPPY DISK TO PRINTER	Calls DSK2 for selection of a measurement data file to be output to the printer.	None
PRESS <ENTER> TO SELECT	Pressing the Enter key implements your menu selection.	None

*Menu PM4, Disk Output Operations*



MENU	DESCRIPTION	GPIB COMMAND
DISK FILE OPTIONS		None
DESTINATION		None
HARD DISK	Selects the output drive destination for the disk file to the hard disk (C:).	None
FLOPPY DISK	Selects the output drive destination for the disk file to the floppy disk (A:).	None
FORMAT		None
TEXT	Text format, predefined.	SAVE "*.TXT"
S2P	S2P format, predefined.	SAVE "*.SP2"
TABULAR DATA	Tabular data format is configured via the Print Options (Menu PM5) or Tabular Data (Menu PM3).	SAVE "*.DAT"
BITMAP	Bitmap format is configured via the Print Options (Menu PM5), Options (Menu PM5, or Graphical Data (Menu PM3A).	SAVE "*.BMP"
HPGL	HPGL format is configured via the Plot Options (Menu PL1).	SAVE "*.HGL"
PRESS <ENTER> TO SELECT	Pressing the Enter key implements your menu selection.	None
USE <START PRINT> TO CAPTURE DATA	Press the Start Print key at the moment data is to be captured. This calls menu DSK3 to create a new file or overwrite an existing file in the current directory.	None

*Menu PM4A, Disk File Options*

MENU	DESCRIPTION	GPIB COMMAND
PRINT OPTIONS		None
PRINTER TYPE		None
THINKJET	Select when HP QuietJet or HP ThinkJet is connected to 37XXXD VNA.	None
DESKJET	Select when HP DeskJet (B/W) or HP LaserJet II and III series is connected to 37XXXD VNA.	None
EPSON	Select when Epson FX, Epson MX, or Epson 9-pin compatible is connected to 37XXXD VNA.	None
FORMAT OF PRINTER OUTPUT		None
GRAPHICAL DATA	Prints only the graph or Smith chart, including any and all data it contains.	None
TABULAR DATA	Prints a tabulation of the measured data	None
PRESS <ENTER> TO SELECT	Pressing the Enter key implements your menu selection.	None

*Menu PM5, Printer Type, Options*

MENU	DESCRIPTION	GPIB COMMAND
RECEIVER MODE		None
STANDARD	Selects STANDARD mode (RECEIVER mode is not activated).	SDR; SDR?
USER DEFINED	Calls menu RCV2, which lets you define rEceiver Mode parameters.	None
SOURCE CONFIG	Calls menu SC, which lets you configure the frequency source.	None
SPUR REDUCTION NORMAL/OFF	Switches between NORMAL and OFF for hardware spur reduction. Hardware control may not be available.	SPR1; SPR0; SPRX?
PRESS <ENTER> TO SELECT OR SWITCH	Pressing the ENTER key implements or switches your menu selection.	None

*Menu RCV1, Receiver Mode*

MENU	DESCRIPTION	GPIB COMMAND
STANDARD RECEIVER MODE		None
WARNING:  CONTINUING MAY INVALIDATE CURRENT SETUP AND CALIBRATION  PRESS <ENTER> TO CONTINUE	Pressing the ENTER key implements your menu selection.	None
PRESS <CLEAR> TO ABORT	Pressing the CLEAR key aborts the Receiver Mode.	None

*Menu RCV1\_WARN, Standard Receiver Mode Warning*

MENU	DESCRIPTION	GPIB COMMAND
USER DEFINED RECEIVER MODE		None
SOURCE LOCK	Phase locks sources having phase control reference inputs.	SL1
TRACKING	Phase locks 37XXXD receivers to a known frequency source.	TK1
SET ON	Disables source lock circuitry, local oscillators are phase locked to the 37XXXD internal crystal reference oscillator.	ST1
PRESS ENTER TO SELECT	Pressing the Enter key implements your menu selection or turns GPIB control on or off.	None

*Menu RCV2, User Defined Receiver Mode Menu*

MENU	DESCRIPTION	GPIB COMMAND
USER DEFINED RECEIVER MODE		None
SET ON WITH GPIB CONTROL	(Warning could also read "SOURCE LOCK," "TRACKING," or "WITHOUT" instead of "SET ON").	None
WARNING: CONTINUING MAY INVALIDATE CURRENT SETUP AND CALIBRATION		None
PRESS <ENTER> TO CONTINUE	Pressing the ENTER key implements your menu selection.	None
PRESS <CLEAR> TO ABORT	Pressing the CLEAR key aborts the Receiver Mode.	None

*Menu RCV2\_WARN, User Defined Receiver Mode Warning*

MENU	DESCRIPTION	GPIB COMMAND
STANDARD RECEIVER MODE	Indicates that Standard Receiver mode has been selected.	None
WARNING:  CONTINUING WILL ERASE CURRENT SETUP AND CALIBRATION	Indicates that continuing (by pressing the Enter key) will erase current setup and calibration stored in the VNA.	None

*Menu RCV3, Standard Receiver Mode Warning Menu*

MENU	DESCRIPTION	GPIB COMMAND
USER DEFINED RECEIVER MODE		None
XXXXXXXX	Indicates selected mode	
WARNING:  CONTINUING WILL ERASE CURRENT SETUP AND CALIBRATION	Indicates that continuing (by pressing the Enter key) will erase current setup and calibration stored in the VNA.	None
PRESS <ENTER> TO CONTINUE  OR  PRESS <CLEAR> TO ABORT	Pressing Enter key implements selected mode.  Pressing the CLEAR key aborts the selected mode; current setup and calibration data stored in the VNA is preserved.	None

*Menu RCV4, User Defined Receiver Mode Warning Menu*

MENU	DESCRIPTION	GPIB COM- MAND
REFERENCE PLANE		None
AUTO	Automatically sets the reference delay so that the cumulative phase shift is zero. This selection unwinds the phase in a Smith chart display or reduces the phase revolutions in a rectilinear display to less than one.	RDA
DISTANCE XXX.XXXX mm	Electrically repositions the measurement reference plane, as displayed on the active channel, by a distance value entered in millimeters. This selection lets you compensate for the phase reversals inherent in a length of transmission line connected between the test set's Port 1 connector and the device-under-test (DUT).	RDD; RDD?
TIME XXX.XXXX ms	Electrically repositions the measurement reference plane by a distance value that corresponds to the time in milliseconds.	RDT; RDT?
SET DIELECTRIC XXX	Displays menu RD2, which lets you enter a value for the dielectric constant of your transmission line.	DIE
CONSTANT OFFSET	Lets the user apply a constant offset vector to the channel data. A constant magnitude and phase can be applied to the data just after the reference plane is applied. The constant offset is independent of frequency and media dispersion.	
MAGNITUDE +XXX.XXX dB	The magnitude is entered in dB and the phase in degrees. These values are combined into a vector where the magnitude is converted from Log to Linear. The channel data is then vector multiplied by this vector.	MOSET; MOSET?
PHASE +XXX.XXX°		POSET; POSET?
PRESS <ENTER> TO SELECT	Pressing the Enter key implements your menu selection.	None

*Menu RD1, Set Reference Delay*



MENU	DESCRIPTION	GPIB COMMAND
SET DIELECTRIC CONSTANT		None
AIR (1.000649)	Calculates reference delay based on dielectric constant of air (1.000649).	DIA
POLYETHYLENE (2.26)	Calculates reference delay based on the dielectric constant of polyethylene (2.26).	DIP
TEFLON (2.10)	Calculates reference delay based on the dielectric constant of teflon (2.1).	DIT
MICROPOROUS TEFLON (1.69)	Calculates reference delay based on the dielectric constant of microporous teflon (1.69).	DIM
OTHER XXXX.XX	Calculates reference delay based on the value you enter. Terminate your entry using any terminator and select with the Enter key.	DIE
PRESS <ENTER> TO SELECT	Pressing the Enter key implements your menu selection and returns you to the RD1 menu.	None

*Menu RD2, Set Dielectric Constant*

MENU	DESCRIPTION	GPIB COMMAND
SOURCE CONFIG		None
SOURCE 1		None
ACTIVE/ INACTIVE	Enables and disables the internal source.	SRC1AC; SRC1AC?
SOURCE LOCATION INTERNAL / EXTERNAL	Changes location of source 1 from internal to external (NOT CURRENTLY SUPPORTED).	None
GPIB ADDRESS 4	Changes GPIB address of external source 1.	SRC1ADD; SRC1ADD?
GPIB CONTROL ON (OFF)	Disables GPIB control of external source 1.	SRC1G1; SRC1G0; SRC1GX?
SOURCE 2		
ACTIVE/ INACTIVE	Enables and disables the external source 2.	SRC2AC; SRC2AC?
SOURCE LOCATION EXTERNAL		None
GPIB ADDRESS 5	4 Changes GPIB address of external source 2.	SRC2ADD; SRC2ADD?
GPIB CONTROL ON (OFF)	Disables GPIB control of external source 2.	SRC2G1; SRC2G0; SRC2GX?
PRESS <ENTER> TO SELECT OR TURN ON/OFF	Pressing the Enter key implements your menu selection.	

*Menu SC, Source Configure*

MENU	DESCRIPTION	GPIB COMMAND
SELECT PARAMETER		None
S21, FWD TRANS b2 / a1	Selects the S <sub>21</sub> parameter to be displayed on the active channel. The parameter can be displayed in any of the available formats.	S21
S11, USER 2 b2 / 1	Selects the S <sub>11</sub> parameter to be displayed on the active channel. The parameter can be displayed in any of the available formats.	S11
S12, REV TRANS b1 / a2	Selects the S <sub>12</sub> parameter to be displayed on the active channel. The parameter can be displayed in any of the available formats.	S12
S22, REV REFL b2 / a2	Selects the S <sub>22</sub> parameter to be displayed on the active channel. The parameter can be displayed in any of the available formats.	S22
EXT ANALOG IN	Switches from a S-parameter or user-defined parameter to an external analog input. This is measured from the rear panel <b>Ext Anlg In</b> connector input. The values may be seen on the Real graph type where 1 Unit = 1 Volt.	EANAIN
PRESS <ENTER> TO SELECT	Pressing the Enter key implements your menu selection.	None
PRESS <1> TO REDEFINE SELECTED PARAMETER	Calls menu PD1, which lets you redefine the selected parameter.	None

*Menu SP, Select S Parameter*

MENU	DESCRIPTION	GPIB COMMAND
SAVE/RECALL FRONT PANEL AND CAL DATA		None
SAVE RECALL	Calls menu SR2, which asks you to select a storage location—internal memory or disk.	None
PRESS <ENTER> TO SELECT FUNCTION	Pressing the Enter key implements your selection.	None

*Menu SR1, Save/Recall Front Panel Information*

MENU	DESCRIPTION	GPIB COMMAND
RECALL (OR SAVE)		None
FRONT PANEL SETUP IN INTERNAL MEMORY	Calls menu SR3, which lets you save the front panel setup into or recall it from internal memory.	None
FRONT PANEL SETUP AND CAL DATA ON HARD DISK	Calls menu DKS2 or DSK3, which let you recall or save to hard disk memory.	None
FRONT PANEL SETUP AND CAL DATA ON FLOPPY DISK	Calls menu DKS2 or DSK3, which let you recall or save to floppy disk memory.	None
PRESS <ENTER> TO SELECT	Pressing the Enter key implements your selection. The menu remains on the screen until another menu is selected for display or until the Clear/Ret Loc key is pressed.	None

*Menu SR2, Recall or Save*

MENU	DESCRIPTION	GPIB COMMAND
SAVE FRONT PANEL SETUP TO (RECALL FRONT PANEL SETUP FROM) INTERNAL MEMORY		None
MEMORY 1*	Causes the current front panel setup to be saved to memory location 1. If an asterisk appears beside the selection, the memory is full. Select a different memory location.	SV1; RC1
MEMORY 2	Same as above, except the setup saves to memory location 2.	SV2; RC2
MEMORY 3	Same as above, except the setup saves to memory location 3.	SV3; RC3
MEMORY 4*	Same as above, except the setup saves to memory location 4.	SV4; RC4
MEMORY 5*	Same as above, except the setup saves to memory location 5.	SV5; RC5
MEMORY 6	Same as above, except the setup saves to memory location 6.	SV6; RC6
MEMORY 7	Same as above, except the setup saves to memory location 7.	SV7; RC7
MEMORY 8	Same as above, except the setup saves to memory location 8.	SV8; RC8
MEMORY 9	Same as above, except the setup saves to memory location 9.	SV9; RC9
MEMORY 10	Same as above, except the setup saves to memory location 10.	SV10; RC10
PRESS <ENTER> TO SELECT OR USE KEYPAD	Pressing the Enter key implements your menu selection.	None

*Menu SR3, Save to Internal memory*

MENU	DESCRIPTION	GPIB COMMAND
SET SCALING OR PRESS <AUTOSCALE>		None
–LOG MAG–		None
RESOLUTION XX.XXX dB/DIV	Sets the resolution for the vertical axis of the active channel's displayed graph. Resolution can be set incrementally using the keypad or rotary knob.	SCL; SCL?; SCL2; SCL2?
REFERENCE VALUE XXX.XXX dB	Sets the value at the reference line for the active channel amplitude measurement on the log-magnitude graph. The value can be set in increments of 0.001 dB using the keypad or rotary knob.	OFF; OFF? OFF2; OFF2?
REFERENCE LINE X	Sets the reference line for the active channel's amplitude measurement on the log-magnitude graph. This is the line about which the amplitude expands with different resolution values. The reference line can be set to any vertical division using the rotary knob.	REF; REF?; REF2; REF2?
–PHASE–		None
RESOLUTION XX.XX ° /DIV	Sets the resolution for the vertical axis of the active channel's displayed phase graph. Resolution can be set incrementally using the keypad or rotary knob.	SCL; SCL?; SCL2; SCL2?
REFERENCE VALUE XXX.XX °	Sets the value at the reference line for the active channel amplitude measurement on the phase graph. The value can be set in increments of 0.001 dB using the keypad or rotary knob.	OFF; OFF? OFF2; OFF2?
REFERENCE LINE X	Sets the reference line for the active channel's phase measurement on the phase graph. This is the line about which the phase expands with different resolution values. The reference line can be set to any vertical division using the rotary knob.	REF; REF?; REF2; REF2?
PHASE SHIFT X.XX °	Sets the value by which the active channel's phase measurement is shifted on the phase graph. The shift can be set in increments of 0.01 degrees using the keypad or rotary knob. This is useful when phase data is near the 180 degree rollover value.	PHO; PHO?
PRESS <ENTER> TO RESUME CAL	On the CAL_SS1 menu, pressing the Enter key returns you to the calibration setup or sequence.	None

*Menu SS1 or CAL\_SS1, Set Scaling 1*

MENU	DESCRIPTION	GPIB COMMAND
SET SCALING OR PRESS <AUTOSCALE>		None
–LINEAR POLAR–		None
RESOLUTION XX.XXX U/DIV	Sets the resolution for the vertical axis of the active channel's displayed graph. Resolution can be set incrementally using the keypad or rotary knob. The center is fixed at 0 units; therefore, changing the resolution also changes the reference value and vice versa	SCL; SCL?; SCL2; SCL2?
REFERENCE VALUE XXX.XXX U	Sets the value at the reference line for the active channel amplitude measurement on the displayed graph. The value can be set in increments of 0.001 U using the keypad or rotary knob.	OFF; OFF? OFF2; OFF2?
FIXED REFERENCE LINE	Sets the reference line for the active channel's amplitude measurement. This is the line about which the amplitude expands with different resolution values. The reference line can be set to any vertical division using the rotary knob.	REF; REF?; REF2; REF2?
SELECT POLAR CHART MODE MAGNITUDE PHASE	Calls menu PC1, which lets you define the phase angles between which your polar chart will display data.	None
PRESS <ENTER> TO SELECT AND RESUME CAL	Pressing the Enter key implements your menu selection and resumes the calibration from where it left off, if in the calibration mode.	None

*Menu SS2 or CAL\_SS2, Set Scaling 2*



MENU	DESCRIPTION	GPIB COMMAND
SET SCALING OR PRESS <AUTOSCALE>		None
IMPEDANCE (ADMITTANCE) SMITH CHART	Scales an Impedance Smith chart for display in the active channel.	SMI; ISM
NORMAL SMITH (REFL = 1.0000000 FULL SCALE)	Selects a normal Smith chart for display in the active channel.	SMI; ISM
EXPAND 10 dB (REFL = 0.3162278 FULL SCALE)	Selects a 10 dB expansion of the Smith chart being displayed for the active channel.	SME10DB; ISM10DB
EXPAND 20 dB (REFL = 0.1000000 FULL SCALE)	Selects a 20 dB expansion of the Smith chart being displayed for the active channel.	SME20DB; ISM20DB
EXPAND 30 dB (REFL = 0.0316228 FULL SCALE)	Selects a 30 dB expansion of the Smith chart being displayed for the active channel.	SME30DB; ISM30DB
COMPRESS 3 dB (REFL = 1.425375 FULL SCALE)	Selects a 3 dB compression of the Smith chart being displayed for the active channel.	SMC3DB; ISM3DB
PRESS <ENTER> TO SELECT AND RESUME CAL	On the CAL_SS3Z or Y menu, pressing the Enter key returns you to the calibration setup or sequence.	None
PRESS <ENTER> TO SELECT	Pressing the ENTER key implements your menu selection and resumes the calibration from where it left off, if in the calibration mode.. The menu remains on the screen until another menu is selected for display or until the CLEAR/RET LOC key is pressed.	None

*Menu SS3Z/SS3Y or CAL\_SS3Z/CALSS3Y, Set Scaling 3*

MENU	DESCRIPTION	GPIB COMMAND
SET SCALING OR PRESS <AUTOSCALE>		None
-LOG MAG-		None
RESOLUTION XX.XXX dB/DIV	Sets the resolution for the vertical axis of the active channel's displayed graph. Resolution can be set incrementally using the keypad or rotary knob.	SCL; SCL?; SCL2; SCL2?
REFERENCE VALUE XXX.XXX dB	Sets the value at the reference line for the active channel amplitude measurement on the displayed graph. The value can be set in increments of 0.001 dB using the keypad or rotary knob.	OFF; OFF? OFF2; OFF2?
REFERENCE LINE X	Sets the reference line for the active channel's amplitude measurement on the log-magnitude graph. This is the line about which the amplitude expands with different resolution values. The reference line can be set to any vertical division using the rotary knob.	REF; REF?; REF2; REF2?
PRESS <ENTER> TO RESUME CAL	On the CAL_SS4 menu, pressing the Enter key returns you to the calibration setup or sequence.	None

*Menu SS4 or CAL\_SS4, Set Scaling 4*

MENU	DESCRIPTION	GPIB COMMAND
SET SCALING OR PRESS <AUTOSCALE>		None
–PHASE–		None
RESOLUTION XX.XXX °/DIV	Sets the resolution for the vertical axis of the active channel's displayed graph. Resolution can be set incrementally using the keypad or rotary knob.	SCL; SCL?; SCL2; SCL2?
REFERENCE VALUE XXX.XXX °	Sets the value at the reference line for the active channel amplitude measurement on the displayed graph. The value can be set in increments of 0.01 ° using the keypad or rotary knob.	OFF; OFF? OFF2; OFF2?
REFERENCE LINE X	Sets the reference line for the active channel's amplitude measurement. This is the line about which the amplitude expands with different resolution values. The reference line can be set to any vertical division using the rotary knob.	REF; REF?; REF2; REF2?
PHASE SHIFT X.XX °	Sets the value by which the active channel's phase measurement is shifted on the phase graph. The shift can be set in increments of 0.01 degrees using the keypad or rotary knob. This is useful when phase data is near the 180 degree rollover value.	PHO; PHO?
PRESS <ENTER> TO RESUME CAL	On the CAL_SS5 menu, pressing the Enter key returns you to the calibration setup or sequence.	v

*Menu SS5 or CAL\_SS5, Set Scaling 5*

MENU	DESCRIPTION	GPIB COMMAND
SET SCALING OR PRESS <AUTOSCALE>		None
–LOG POLAR–		None
RESOLUTION XX.XXX dB/DIV	Sets the resolution for the vertical axis of the active channel's displayed graph. Resolution can be set incrementally using the keypad or rotary knob.	SCL; SCL? SCL2; SCL2?
REFERENCE VALUE XXX.XXX dB	Sets the value at the reference line for the active channel amplitude measurement on the displayed graph. The value can be set in increments of 0.001 dB using the keypad or rotary knob.	OFF; OFF? OFF2; OFF2?
FIXED REFERENCE LINE	Sets the reference line for the active channel's amplitude measurement. This is the line about which the amplitude expands with different resolution values. The reference line can be set to any vertical division using the rotary knob.	REF; REF? REF2; REF2?
SELECT POLAR CHART MODE MAGNITUDE PHASE	Calls menu PC1, which lets you define the phase angles between which your polar chart will display data.	None
PRESS <ENTER> TO SELECT AND RESUME CAL	Pressing the Enter key implements your menu selection and resumes the calibration from where it left off, if in the calibration mode.	None

*Menu SS6 or CAL\_SS6, Set Scaling 6*

MENU	DESCRIPTION	GPIB COMMAND
SET SCALING OR PRESS <AUTOSCALE>		None
–GROUP DELAY–		None
RESOLUTION XX.XXX fs/DIV	Sets the resolution for the vertical axis of the active channel's displayed graph. Resolution can be set incrementally using the keypad or rotary knob.	SCL; SCL?; SCL2; SCL2?
REF VALUE XXX.XXX fs	Sets the value at the reference line for the active channel amplitude measurement on the displayed graph. The value can be set in increments of 0.0001 s using the keypad or rotary knob.	OFF; OFF? OFF2; OFF2?
REFERENCE LINE X	Sets the reference line for the active channel's amplitude measurement. This is the line about which the amplitude expands with different resolution values. The reference line can be set to any vertical division using the rotary knob.	REF; REF?; REF2; REF2?
APERTURE X.X PERCENT OF SWEEP	Sets and displays the percent of frequency span over which group delay is calculated.	APR; APR?
PRESS <ENTER> TO RESUME CAL	On the CAL_SS7 menu, pressing the Enter key returns you to the calibration setup or sequence.	None

*Menu SS7 or CAL\_SS7, Set Scaling 7*

MENU	DESCRIPTION	GPIB COMMAND
SET SCALING OR PRESS <AUTOSCALE>		None
–LINEAR MAG–		None
RESOLUTION XX.XXX U/DIV	Sets the resolution for the vertical axis of the active channel's displayed graph. Resolution can be set incrementally using the keypad or rotary knob.	SCL; SCL?; SCL2; SCL2?
REFERENCE VALUE XXX.XXX pU	Sets the value at the reference line for the active channel amplitude measurement on the displayed graph. The value can be set in increments of 0.001 U using the keypad or rotary knob.	OFF; OFF? OFF2; OFF2?
REFERENCE LINE X	Sets the reference line for the active channel's amplitude measurement. This is the line about which the amplitude expands with different resolution values. The reference line can be set to any vertical division using the rotary knob.	REF; REF?; REF2; REF2?
PRESS <ENTER> TO RESUME CAL	On the CAL_SS8 menu, pressing the Enter key returns you to the calibration setup or sequence.	None

*Menu SS8 or CAL\_SS8, Set Scaling 8*

MENU	DESCRIPTION	GPIB COMMAND
SET SCALING OR PRESS <AUTOSCALE>		None
–LINEAR MAG–		None
RESOLUTION XX.XXX U/DIV	Sets the resolution for the vertical axis of the active channel's displayed graph. Resolution can be set incrementally using the keypad or rotary knob.	SCL; SCL?; SCL2; SCL2?
REFERENCE VALUE XXX.XXX pU	Sets the value at the reference line for the active channel amplitude measurement on the displayed graph. The value can be set in increments of 0.001 U using the keypad or rotary knob.	OFF; OFF? OFF2; OFF2?
REFERENCE LINE X	Sets the reference line for the active channel's amplitude measurement. This is the line about which the amplitude expands with different resolution values. The reference line can be set to any vertical division using the rotary knob.	REF; REF?; REF2; REF2?
–PHASE–		None
RESOLUTION XX.XX °/DIV	Sets the resolution for the vertical axis of the active channel's displayed phase graph. Resolution can be set incrementally using the keypad or rotary knob.	SCL; SCL?; SCL2; SCL2?
REF VALUE XXX.XX °	Sets the value by which the active channel's phase measurement is offset on the phase graph. The offset can be set in increments of 0.01 degrees using the keypad or rotary knob.	OFF; OFF? OFF2; OFF2?
REFERENCE LINE X	Sets the reference line for the active channel's phase measurement on the phase graph. This is the line about which the phase expands with different resolution values. The reference line can be set to any vertical division using the rotary knob.	REF; REF?; REF2; REF2?
PHASE SHIFT X.XX °	Sets the value by which the active channel's phase measurement is shifted on the phase graph. The shift can be set in increments of 0.01 degrees using the keypad or rotary knob. This is useful when phase data is near the 180 degree rollover value.	PHO; PHO?
PRESS <ENTER> TO RESUME CAL	On the CAL_SS9 menu, pressing the Enter key returns you to the calibration setup or sequence.	None

*Menu SS9 or CAL\_SS9, Set Scaling 9*

MENU	DESCRIPTION	GPIB COMMAND
SET SCALING OR PRESS <AUTOSCALE>		None
-REAL-		None
RESOLUTION XX.XXX U/DIV	Sets the resolution for the vertical axis of the active channel's displayed graph. Resolution can be set incrementally using the keypad or rotary knob.	SCL; SCL?; SCL2; SCL2?
REFERENCE VALUE XXX.XXX pU	Sets the value at the reference line for the active channel amplitude measurement on the displayed graph. The value can be set in increments of 0.001 U using the keypad or rotary knob.	OFF; OFF? OFF2; OFF2?
REFERENCE LINE X	Sets the reference line for the active channel's amplitude measurement. This is the line about which the amplitude expands with different resolution values. The reference line can be set to any vertical division using the rotary knob.	REF; REF?; REF2; REF2?
PRESS <ENTER> TO RESUME CAL	On the CAL_SS10 menu, pressing the Enter key returns you to the calibration setup or sequence.	None

*Menu SS10 or CAL\_SS10, Set Scaling 10*



MENU	DESCRIPTION	GPIB COMMAND
SET SCALING OR PRESS <AUTOSCALE>		None
-IMAGINARY-		None
RESOLUTION XX.XXX U/DIV	Sets the resolution for the vertical axis of the active channel's displayed graph. Resolution can be set incrementally using the keypad or rotary knob.	SCL; SCL?; SCL2; SCL2?
REFERENCE VALUE XXX.XXX pU	Sets the value at the reference line for the active channel amplitude measurement on the displayed graph. The value can be set in increments of 0.001 U using the keypad or rotary knob.	OFF; OFF? OFF2; OFF2?
REFERENCE LINE X	Sets the reference line for the active channel's amplitude measurement. This is the line about which the amplitude expands with different resolution values. The reference line can be set to any vertical division using the rotary knob.	REF; REF?; REF2; REF2?
PRESS <ENTER> TO RESUME CAL	On the CAL_SS11 menu, pressing the Enter key returns you to the calibration setup or sequence.	None

*Menu SS11 or CAL\_SS11, Set Scaling 11*

MENU	DESCRIPTION	GPIB COMMAND
SET SCALING OR PRESS <AUTOSCALE>		None
–REAL–		None
RESOLUTION XX.XXX U/DIV	Sets the resolution for the vertical axis of the active channel's displayed graph. Resolution can be set incrementally using the keypad or rotary knob.	SCL; SCL?; SCL2; SCL2?
REFERENCE VALUE XXX.XXX pU	Sets the value at the reference line for the active channel amplitude measurement on the displayed graph. The value can be set in increments of 0.001 U using the keypad or rotary knob.	OFF; OFF? OFF2; OFF2?
REFERENCE LINE X	Sets the reference line for the active channel's amplitude measurement. This is the line about which the amplitude expands with different resolution values. The reference line can be set to any vertical division using the rotary knob.	REF; REF?; REF2; REF2?
–IMAGINARY–		None
RESOLUTION XX.XX °/DIV	Sets the resolution for the vertical axis of the active channel's displayed graph. Resolution can be set incrementally using the keypad or rotary knob.	SCL; SCL?; SCL2; SCL2?
REFERENCE VALUE XXX.XX °	Sets the value by which the active channel's phase measurement is offset on the phase graph. The offset can be set in increments of 0.01 degrees using the keypad or rotary knob.	OFF; OFF? OFF2; OFF2?
REFERENCE LINE X	Sets the reference line for the active channel's phase measurement on the phase graph. This is the line about which the phase expands with different resolution values. The reference line can be set to any vertical division using the rotary knob.	REF; REF?; REF2; REF2?
PRESS <ENTER> TO RESUME CAL	On the CAL_SS12 menu, pressing the Enter key returns you to the calibration setup or sequence.	None

*Menu SS12 or CAL\_SS12, Set Scaling 12*

MENU	DESCRIPTION	GPIB COMMAND
SET SCALING OR PRESS <AUTOSCALE>		None
–SWR–		None
RESOLUTION XX.XXX U /DIV	Sets the resolution for the vertical axis of the active channel's displayed graph. Resolution can be set incrementally using the keypad or rotary knob.	SCL; SCL?; SCL2; SCL2?
REFERENCE VALUE XXX.XXX U	Sets the value at the reference line for the active channel amplitude measurement on the displayed graph. The value can be set in increments of 0.001 U using the keypad or rotary knob.	OFF; OFF?; OFF2; OFF2?
REFERENCE LINE X	Sets the reference line for the active channel's amplitude measurement. This is the line about which the amplitude expands with different resolution values. The reference line can be set to any vertical division using the rotary knob.	REF; REF?; REF2; REF2?
PRESS <ENTER> TO RESUME CAL	On the CAL_SS13 menu, pressing the Enter key returns you to the calibration setup or sequence.	None

*Menu SS13 or CAL\_SS13, Set Scaling 13*

MENU	DESCRIPTION	GPIB COMMAND
SET SCALING OR PRESS <AUTOSCALE>		None
–POWER OUT–		None
RESOLUTION XX.XXX dB/DIV	Sets the resolution for the vertical axis of the active channel's displayed graph. Resolution can be set incrementally using the keypad or rotary knob.	SCL; SCL?; SCL2; SCL2?
REFERENCE VALUE XXX.XXX dBm	Sets the value at the reference line for the active channel amplitude measurement on the displayed graph.	OFF; OFF? OFF2; OFF2?
REFERENCE LINE X	Sets the reference line for the active channel's amplitude measurement. This is the line about which the amplitude expands with different resolution values. The reference line can be set to any vertical division using the rotary knob.	REF; REF?; REF2; REF2?

*Menu SS14, Set Scaling 14*

MENU	DESCRIPTION	GPIB COMMAND
SWEEP SETUP		None
START XXX.XXXXXXXXXX GHz	Enter the sweep-start frequency in GHz. The start frequency must be lower than the stop frequency.	SRT
STOP XXX.XXXXXXXXXX GHz	Enter the sweep-stop frequency in GHz. The stop frequency must be higher than the start frequency.	STP
SET CENTER/SPAN	Calls menu SU1_CENTER, which lets you set values for center frequency and span width.	None
XXX DATA POINTS XXX.XXXXXXXXXX GHz STEPSIZE	Displays the number of frequency points and the spacing between points for the start and stop frequencies selected above. The number of points shown provides the finest frequency resolution possible, based on your Data Points key menu selection.	None
C.W. MODE ON (OFF) XXX.XXXXXXXXXX GHz	Move cursor here and press Enter to enable the CW mode. Enter CW frequency for measurements.	CWF; CWON; CWON?; SWP; SWP?
MARKER SWEEP	Move cursor here and press Enter to set the start and stop frequencies (menu SU5) of the CW frequency (menu SU6) to the values of any marker.	None
DISCRETE FILL	Calls the Discrete Fill menu (menu DF1).	None
HOLD BUTTON FUNCTION	Calls menu SU4, which lets you set the action of the HOLD key.	None
TEST SIGNALS	Calls menu SU2, which lets you set the source power and the values for the attenuators in the 37XXXD. It also provides entry into the Flat Test Port Power calibration.	None
PRESS <ENTER> TO SELECT OR TURN ON/OFF	Pressing the ENTER key implements your menu selection.	None

*Menu SU1, Sweep Setup 1*

MENU	DESCRIPTION	GPIB COMMAND
SWEEP SETUP		None
CENTER XXX.XXXXXXXXXX GHz	Enter the center frequency in GHz.	CNTR; CNTR?
SPAN XXX.XXXXXXXXXX GHz	Enter the span frequency in GHz.	SPAN; SPAN?
SET START/STOP	Calls menu SU1, which lets you set values for start and stop frequencies.	None
XXX DATA POINT(S) XXX.XXXXXXXXXX GHz STEPSIZE	Displays the number of frequency points and the spacing between points for the center and span frequencies selected above. The number of points shown provides the finest frequency resolution possible, based on your Data Points key menu selection.	None
C.W. MODE ON (OFF) XXX.XXXXXXXXXX GHz	Move cursor here and press Enter to enable the CW mode. Enter CW frequency for measurements.	CWF; CWON; SWP; CWON?
MARKER SWEEP	Move cursor here and press Enter to set the start and stop frequencies (menu SU5) of the CW frequency (menu SU6) to the values of any marker.	None
DISCRETE FILL	Calls the Discrete Fill menu (menu DF1).	None
HOLD BUTTON FUNCTION	Calls menu SU4, which lets you set the action of the HOLD key.	None
TEST SIGNALS	Calls menu SU2, which lets you set the source power and the values for the attenuators in the 37XXXD. It also provides entry into the Flat Test Port Power calibration.	None
PRESS <ENTER> TO SELECT OR TURN ON/OFF	Pressing the ENTER key implements your menu selection.	None

*Menu SU1\_CENTER, Sweep Setup 1*

MENU	DESCRIPTION	GPIB COMMAND
TEST SIGNALS		None
POWER CONTROL +XX.X dB 0 TO -15.0 dB)	Enter the delta-power level for the Port 1 output in dB.	PWR; PWR?
PORT 1 ATTN XX10 dB (0 - 70)	Attenuates the microwave source power at port 1 from 0 to 70 dB, in 10 dB steps. The power is attenuated before being applied to Port 1 for a forward transmission or reflection test ( $S_{21}$ or $S_{11}$ , respectively).	SA1; SA1?
PORT 1 POWER -XX.XX dBm	Displays the Port 1 power, in dBm.	PIP?
PORT 2 ATTN XX10 dB (0-X0)	Attenuates from 0 to 40 dB (10 dB steps) the microwave power being input to Port 2 from the device-under-test (DUT).	TA2; TA2?
CALIBRATE FOR FLATNESS (CAL EXISTS)		None
FLATNESS ON(OFF) CORRECTION AT XX.X dBm	Calls menu SU8 or CAL_SU8, depending on whether valid Flat Test Port Power calibration data exists. Both of these menus provide selection control for the Flat Test Port Power feature.	FP0; FP1; FPX?
EXT SOURCE 1 PWR -XX.XX dBm	Enter the power level, in dBm, of the 1st, external frequency source.	PWR1; PWR1?
EXT SOURCE 2 PWR -XX.XX dBm	Enter the power level, in dBm, of the 2nd, external frequency source.	PW2; PW2?
PREVIOUS MENU	Returns to the previous menu.	None

*Menu SU2 or CAL\_SU2, Sweep Setup 2*

MENU	DESCRIPTION	GPIB COMMAND
TEST SIGNALS		None
EXT SOURCE 1 PWR +XX.XX dBm	Enter and display the power level, in dBm, of the 1st external frequency source.	PWR1; PWR1?
EXT SOURCE 2 PWR +XX.XX dBm	Enter and display the power level, in dBm, of the 2nd, external frequency source.	PW2; PW2?
PORT 1 ATTN 0 * 10 dB (0 - 70)	Attenuates the microwave source power at port 1 from 0 to 70 dB, in 10 dB steps. The power is attenuated before being applied to Port 1 for a forward transmission or reflection test ( $S_{21}$ or $S_{11}$ , respectively). (NO STEP ATTENUATOR IN MODEL 372XXC)	SA1; SA1?
PORT 2 ATTN 0 * 10 dB (0 - 00)	Attenuates from 0 to 40 dB (10 dB steps) the microwave power being input to Port 2 from the device-under-test (DUT).	TA2; TA2?
PREVIOUS MENU	Returns you to the previous menu. (RESUME CAL may be used instead of PREVIOUS MENU, when accessed during a calibration.)	None
PRESS <ENTER> TO SELECT OR TURN ON/OFF	Pressing the Enter key implements your menu selection.	None

*Menu SU2A or CAL\_SU2A, Sweep Setup 2A*



MENU	DESCRIPTION	GPIB COMMAND
SINGLE POINT MEASUREMENT SETUP		None
C.W. FREQ XXX.XXXXXXXXXX GHz	Enter the measurement frequency in GHz for continuous wave (CW) operation.	CWF; CWF?
HOLD BUTTON FUNCTION	Calls menu SU4, which lets you set the action of the HOLD key.	None
TEST SIGNALS	Calls menu SU2, which lets you set values for the source power and attenuators. It also provides entry into the Flat Test Port Power calibration.	None
RETURN TO SWEEP MODE	Move cursor here and press Enter to return to the F1-F2 sweep mode (Menu SU1).	None
PRESS <ENTER> TO SELECT	Pressing the Enter key implements your menu selection.	None

*Menu SU3, Single-Point Measurement Setup*

MENU	DESCRIPTION	GPIB COMMAND
SWEPT POWER SETUP		None
SWEPT POWER FREQUENCY XXX.XXXXXXXXXX GHz	Enter the swept-power frequency in GHz.	None
P START -XX.XX dBm	Displays the start power value in dBm.	PSTRT; PSTRT?
P STOP -XX.XX dBm	Displays the stop power value in dBm.	PSTOP; PSTOP?
STEP SIZE -XX.XX dB	Displays the power step size value in dB.	PSTEP; PSTEP?
POWER SWEEP ON(OFF) -XX.XX dBm	Turns power sweep on or off.	PSWP1; PSWP0; PSWPX?
HOLD BUTTON FUNCTION	Calls menu SU4.	None
SWEPT POWER GAIN COMPRESSION	Calls menu GC3 and extended menu EXT_GC3.	None
RETURN TO SWEPT FREQUENCY MODE	Calls menu SU1.	None
PRESS <ENTER> TO SELECT OR TURN ON/OFF	Pressing the Enter key implements your menu selection.	None

*Menu SU3A, Swept-Power Measurement Setup*

MENU	DESCRIPTION	GPIB COMMAND
SELECT FUNCTION FOR HOLD BUTTON		None
HOLD/CONTINUE	Causes the hold key (button) to stop and start the sweep.	HLD/CTN; HLD?
HOLD/RESTART	Causes the hold key to stop and restart the sweep.	None
SINGLE SWEEP AND HOLD	Causes the hold key to trigger a single sweep and hold when finished. (Two sweeps, one from Port 1 to 2 and another from Port 2 to 1, are accomplished for a 12-Term measurement.)	HLD; TRS
BIAS/RF HOLD CONDITIONS		
BIAS      ON (OFF)	Select bias to be on or off (test sets having bias input only) while system is in hold.	BH1; BH0; BHX?
RF          ON (OFF)	Selects RF to be on or off while system is in hold.	RH1; RH0; RHX?
DUT/AUT ON (OFF) PROTECTION DEFAULT RESET TURNS ON HOLD WITH BIAS/RF TURNED OFF	When on, a default reset places the system in hold with RF and bias turned off. This choice is initialized to OFF when the software version changes or after a Default Program key press, so that the system comes up in the sweep mode.	
PRESS <ENTER> TO SELECT	Pressing the Enter key implements your menu selection.	None

*Menu SU4, Select Function for Hold Button*

MENU	DESCRIPTION	GPIB COMMAND
FREQUENCY MARKER SWEEP		None
START SWEEP MARKER (X) XXX.XXXXXXXXXX GHz	Pressing a number on the keypad causes the associated marker to be the start frequency of the sweep.	M1S–M6S
STOP SWEEP MARKER (X) XXX.XXXXXXXXXX GHz	Pressing a number on the keypad causes the associated marker to be the stop frequency of the sweep.	M1E–M6E
USE KEYPAD TO SELECT MARKER (1-6)	Use the keypad to select markers 1, 2, 3, 4, 5, or 6.	None

*Menu SU5, Frequency Marker Sweep*

MENU	DESCRIPTION	GPIB COMMAND
FREQUENCY MARKER C.W.		None
C.W. FREQ MARKER (X) XXX.XXXXXXXXXX GHz	Pressing a number on the keypad causes the associated marker to be the C.W. frequency.	M1C-M6C
USE KEYPAD TO SELECT MARKER (1-6)	Use the keypad to select markers 1, 2, 3, 4, 5, or 6.	None

*Menu SU6, Frequency Marker C.W.*

MENU	DESCRIPTION	GPIB COMMAND
CALIBRATE FOR FLAT PORT POWER		None
FORWARD DIRECTION ONLY		None
XXX POINTS MEASURE 1 PWR POINT EVERY XX POINT(S)	Displays the number of power points (0 – 50) to be skipped during the power sweep. The points not measured are interpolated to provide a flat sweep.	PTS; PTS?
POWER TARGET -XXX.X dBm	Lets users set a flat output-power value (power target). The VNA defaults to Port 1 power.	PTP; PTP?
START FLAT POWER CALIBRATION	Begins the calibration. If calibration is successful, you are returned to menu SU8. If the calibration unsuccessful due to a fatal error (Source or power meter inoperable or not connected), this menus remains displayed. At any time, you can abort the calibration by pressing the DEFAULT PROGRAM or CLEAR/RET LOC keys. All other keys are locked out.	SFC
PRESS <ENTER> TO SELECT	Pressing the Enter key implements your menu selection or turns the function on/off.	None
TURN KNOB TO CHANGE NUMBER OF POINTS		

*Menu SU8 or CAL\_SU8, Calibrate For Flat Test Port Power*

- FLAT POWER CALIBRATION -

FLAT POWER CALIBRATION ADJUSTS THE SOURCE OUTPUT POWER AT EACH MEASUREMENT POINT ACROSS A FREQUENCY SPAN TO PROVIDE A CONSTANT POWER LEVEL AT THE TEST PORT (FORWARD DIRECTION ONLY).

- INSTRUCTIONS -

1. PRESET, ZERO, AND CALIBRATE THE POWERMETER.
2. CREATE AND ACTIVATE THE POWERMETER'S CAL FACTOR LIST FOR THE POWER SENSOR BEING USED.
3. CONNECT THE POWERMETER TO THE DEDICATED GPIB INTERFACE AND THE POWER SENSOR TO THE TEST PORT.
4. SELECT <START FLAT POWER CALIBRATION>.

000.0 9

*Menu EXT\_SU8 Flat Power Calibration Instructions*

MENU	DESCRIPTION	GPIB COMMAND
NUMBER OF DATA POINTS		None
1601 MAX PTS	Selects measurement data points to be 1601.	NP1601; FHI; ONP
801 MAX PTS	Selects measurement data points to be 801.	NP801; ONP
401 MAX PTS	Selects measurement data points to be 401.	NP401; ONP; FME
201 MAX PTS	Selects measurement data points to be 201.	NP101; ONP
101 MAX PTS	Selects measurement data points to be 101.	NP101; ONP
51 MAX PTS	Selects measurement data points to be 51.	NP51; ONP
PRESS <ENTER> TO SELECT	Pressing the Enter key implements you selection.	None

*Menu SU9, Number of Data Points*



MENU	DESCRIPTION	GPIB COMMAND
NUMBER OF DATA POINTS		None
POINTS DRAWN IN C.W. XXXX POINT(S)	Displays the number of data point, when in the CW mode. This number can be between 1 and 1601.	CWP; CWP?

*Menu SU9A, Number of Data Points 2*

MENU	DESCRIPTION	GPIB COMMAND
DOMAIN		None
FREQUENCY	Displays the data in normal frequency domain format.	
FREQUENCY WITH TIME GATE	Displays the data in the frequency domain after a specific time range has been sampled by the gate function.	FGT
TIME LOWPASS MODE	Displays the data in the time (distance) domain, using true lowpass processing. Data must be taken using a harmonic series calibration and sweep in order to use this mode.	TLP
TIME BANDPASS MODE	Displays the data in the time (distance) domain using bandpass processing. Any data sweep range using normal calibration can be used.	TBP; TDX?
–SETUP–		None
DISPLAY TIME/DISTANCE	Switches the mode of display between time and distance. This does not affect the actual displayed data, but only the annotation.	TDDIST; TDTIME
SET RANGE	Calls a menu that lets you set the range and other display parameters.	None
SET GATE	Calls a menu that lets you set the gate parameters.	None
GATE ON/OFF/DISP	Switches the gate on or off each time Enter is pressed.	GON/GOF/GDS; GOF?
HELP	Displays an informational help menu.	None
PRESS <ENTER> TO SELECT OR SWITCH	Pressing the Enter key implements your menu selection.	None

*Menu TD1, Domain (Frequency/Display)*

MENU	DESCRIPTION	PIB COMMAND
LOWPASS TIME DOMAIN SETUP		None
START XXX.XXX ps	Sets the start time of the display.	GST; GST?
STOP XXX.XXX ps	Sets the stop time of the display..	GSP; GSP?
CENTER XXX.XXX ps	Sets the center time of the display.	GCT; GCT?
SPAN XXX.XXX ps	Sets the span (Stop - Start) of the display.	GSN; GSN?
MARKER RANGE	Calls a menu that lets you set the display to a range determined by two of the markers.	None
RESPONSE IMPULSE/STEP	Switches between Impulse and Step response each time Enter is pressed.	LPI/LPS; LPSX?
MORE	Calls a menu that contains additional selections for display setup.	None
PRESS <ENTER> TO SELECT	Pressing the Enter key implements your menu selection.	None

*Menu TD2\_LP\_TIME, Lowpass Time Domain Setup*

MENU	DESCRIPTION	GPIB COMMAND
LOWPASS DISTANCE DISPLAY SETUP		None
START XXX.XXX mm	Sets the start time of the display.	GST; GST?
STOP XXX.XXX mm	Sets the stop time of the display.	GSP; GSP?
CENTER XXX.XXX mm	Sets the center time of the display.	GCT; GCT?
SPAN XXX.XXX mm	Sets the span (Stop - Start) of the display.	GSN; GSN?
MARKER RANGE	Calls a menu that lets you set the display to a range determined by two of the markers.	None
RESPONSE IMPULSE/STEP	Switches between Impulse and Step response each time Enter is pressed.	LPI/LPS; LPSX?
MORE	Calls a menu that contains additional selections for display setup.	None
RELATIVE VELOCITY X.X	Indicates the relative velocity of light, as set by the dielectric constant in menu RD2.	None
PRESS <ENTER> TO SELECT	Pressing the Enter key implements your menu selection.	None

*Menu TD2\_LP\_DIST, Lowpass Distance Display Setup*

MENU	DESCRIPTION	GPIB COMMAND
BANDPASS TIME DOMAIN SETUP		None
START XXX.XXX ps	Sets the start time of the display.	ZST; ZST?
STOP XXX.XXX ps	Sets the stop time of the display.	ZSP; ZSP?
CENTER XXX.XXX ps	Sets the center time of the display.	ZCT; ZCT?
SPAN XXX.XXX ps	Sets the span (Stop - Start) of the display.	ZSN; ZSN?
MARKER RANGE	Calls a menu that lets you set the display to a range determined by two of the markers.	None
PHASOR ON/OFF IMPULSE	Switches Phasor Impulse processing on or off each time Enter is pressed.	TDPI1; TDPI0; TDPIX?
HELP – PHASOR IMPULSE	Displays an informational help menu.	None
MORE	Calls a menu that contains additional selections for display setup.	None
PRESS <ENTER> TO SELECT OR TURN ON/OFF	Pressing the Enter key implements your menu selection.	None

*Menu TD2\_BP\_TIME, Bandpass Time Domain Setup*

MENU	DESCRIPTION	GPIB COMMAND
BANDPASS DISTANCE DISPLAY SETUP		None
START XXX.XXX mm	Sets the start time of the display.	ZST; ZST?
STOP XXX.XXX mm	Sets the stop time of the display.	ZSP; ZSP?
CENTER XXX.XXX mm	Sets the center time of the display.	ZCT; ZCT?
SPAN XXX.XXX mm	Sets the span (Stop - Start) of the display.	ZSN; ZSN?
MARKER RANGE	Calls a menu that lets you set the display to a range determined by two of the markers.	None
PHASOR ON/OFF IMPULSE	Switches Phasor Impulse processing on or off each time Enter is pressed.	TDPI1; TDPI0; TDPIX?
HELP – PHASOR IMPULSE	Displays an informational help menu.	None
MORE	Calls a menu that contains additional selections for display setup.	None
RELATIVE VELOCITY X.X	Indicates the relative velocity of light, as set by the dielectric constant in menu RD2.	None
PRESS <ENTER> TO SELECT OR TURN ON/OFF	Pressing the Enter key implements your menu selection.	None

*Menu TD2\_BP\_DIST, Bandpass Distance Display Setup*

MENU	DESCRIPTION	GPIB COMMAND
BANDPASS TIME DOMAIN SETUP		None
WINDOW SHAPE NOMINAL	Calls a menu that lets you change the window type.	None
SET GATE	Calls a menu that lets you set the gate parameters.	None
PREVIOUS MENU	Returns you to the previous menu.	None
PRESS <ENTER> TO SELECT	Pressing the Enter key implements your menu selection.	None

*Menu TD3\_BP, Bandpass Time Domain Setup*

MENU	DESCRIPTION	GPIB COMMAND
LOWPASS TIME DOMAIN SETUP		None
WINDOW SHAPE NOMINAL	Calls a menu that lets you change the window type.	None
SET GATE	Calls a menu that lets you set the gate.	None
D.C. TERM XXXXX XXXXXXXXXX	Calls a menu that lets you set the D.C. term for lowpass processing.	None
PREVIOUS MENU	Returns you to the previous menu.	None
PRESS <ENTER> TO SELECT	Pressing the Enter key implements your menu selection.	None

*Menu TD3\_LP, Lowpass Time Domain Setup*

MENU	DESCRIPTION	GPIB COMMAND
GATE		None
START XXX.XXX xx	Sets the start time of the gate.	GST; GST?
STOP XXX.XXX xx	Sets the stop time of the gate.	GSP; GSP?
CENTER XXX.XXX xx	Sets the center time of the gate.	GCT; GCT?
SPAN XXX.XXX xx	Sets the span (Stop - Start) of the gate. Also, provides for an anti-gate if a negative value is entered. Refer to Chapter 9, paragraphs 9-6 and 9-7 for additional information.	GSN; GSN?
SET SHAPE XXXXXXXXXX	Calls a menu that lets you set the shape of the gate.	None
GATE ON/OFF/DISP	Switches the gate on or off each time Enter is pressed.	GON/GOF/GDS; GOF?
SET RANGE	Takes you back to menu TD2_XX_XXXX (LP_TIME, LP_DIST, BP_TIME, BP_DIST), depending on the type of measurement you selected in menu TD1.	None
PRESS <ENTER> TO SELECT	Pressing the Enter key implements your menu selection.	None

*Menu TD4\_TIME & TD4\_DIST, Gate (Distance/Time)*



MENU	DESCRIPTION	GPIB COMMAND
SELECT WINDOW SHAPE		None
RECTANGULAR	Selects a Rectangular (one-term) shape.	WRT
NOMINAL	Selects a two-term Hamming shape.	WNM
LOW SIDELOBE	Selects a three-term Blackman-Harris shape.	WLS
MIN SIDELOBE	Selects a four-term Blackman-Harris shape.	WMS
HELP	Displays an informational help menu.	None
PRESS <ENTER> TO SELECT	Pressing the Enter key implements your menu selection.	None

*Menu TD5\_WINDOW, Shape*

MENU	DESCRIPTION	GPIB COMMAND
SELECT GATE SHAPE		None
MINIMUM	Selects minimum shape. Sharpest rolloff, some frequency domain ripple. Not allowed with low or minimum sidelobe window.	GRT
NOMINAL	Selects a nominal shape. Good results in most applications. Not allowed with minimum sidelobe window.	GNM
WIDE	Selects wide shape. Gradual rolloff and better residual ripple.	
MAXIMUM	Selects a maximum shape. Least rolloff and best residual ripple.	
HELP	Displays an informational help menu.	None
PRESS <ENTER> TO SELECT	Pressing the Enter key implements your menu selection.	None

*Menu TD5\_GATE, Shape*

MENU	DESCRIPTION	GPIB COMMAND
SET D.C. TERM FOR LOWPASS PROCESSING	Since it is impossible to measure the true D.C. term required for lowpass processing, a value must be estimated. This menu allows a choice between five different selections for this value.	None
AUTO EXTRAPOLATE	Sets the D.C. term to a value determined by extrapolating the data points near the zero frequency.	DCA; DCX?
LINE IMPEDANCE	Sets the D.C. term to the characteristic impedance of the transmission medium ( $Z_0$ ).	DCZ
OPEN	Sets the D.C. term to correspond to an open circuit.	DCO
SHORT	Sets the D.C. term to correspond to a short circuit.	DCS
OTHER XXX.XXX (REFLECTION COEFFICIENT X.XXX pU)	Sets the D.C. term to the value entered.	DCV; DCV?  DCX?
PREVIOUS MENU	Returns you to the previous menu.	None
PRESS <ENTER> TO SELECT	Pressing the Enter key implements your menu selection.	None

*Menu TD6, Set D.C. Term for Low Pass Processing*

MENU	DESCRIPTION	GPIB COMMAND
TIME MARKER SWEEP		None
START TIME MARKER ( ) XXX.XXX ns	Sets the start time to the value of the selected marker.	M1S-M6S
STOP TIME MARKER ( ) XXX.XXX ns	Sets the stop time to the value of the selected marker.	M1E-M6E
RESTORE ORIGINAL RANGE	Returns the display to the original time range that was in effect before the marker range was selected.	MRR
PREVIOUS MENU	Returns you to the previous menu.	None
USE KEYPAD TO CHOOSE MARKER (1 - 6)  PRESS <ENTER> TO SELECT	Select marker number from keypad.  Pressing the Enter key implements your menu selection.	None

*Menu TD7\_TIME, Time Marker Sweep.*

MENU	DESCRIPTION	GPIB COMMAND
DISTANCE MARKER SWEEP		None
START DIST MARKER ( ) XX.XXXX cm	Sets the start time to the value of the selected marker.	M1S–M6S
STOP DIST MARKER ( ) X.XXXX m	Sets the stop time to the value of the selected marker.	M1E–M6E
RESTORE ORIGINAL RANGE	Returns the display to the original time range that was in effect before the marker range was selected.	MRR
PREVIOUS MENU	Returns you to the previous menu.	None
USE KEYPAD TO CHOOSE MARKER (1 - 6)  PRESS <ENTER> TO SELECT	Select marker number from keypad.  Pressing the Enter key implements your menu selection.	None

*Menu TD7\_DIST, Distance Marker Range*

MENU	DESCRIPTION	GPIB COMMAND
TRIGGERS MEASUREMENT		None
INTERNAL	Internally triggers a point-by-point measurement. Choosing this option always turns AUTOMATIC I.F. CALIBRATION off.	TIN; TXX?
EXTERNAL	Provides for externally triggering a point-by-point measurement via the rear panel External Trigger connector. Choosing this option always turns AUTOMATIC I.F. CALIBRATION off.	TEX; TXX?
MEASUREMENT ON (OFF) DELAY XX.XXX sec	Toggles a measurement delay on or off. If toggled on, the delay time is displayed for user entry. Allowed values range from positive 0.1 to 99999.9 ms.	MEASDLY0; MEASDLY1; MEASDLYX?; MEASDLY; MEASDLY?
I.F. CALIBRATION		None
AUTOMATIC ON (OFF) I.F. CAL	Turns on or off the timer for I.F. calibration. The timer automatically triggers an I.F. calibration at regular intervals for internal hardware calibrations. It can be set on or off when in either INTERNAL or EXTERNAL trigger measurement mode.	HC1; HC0; HCX?
TRIGGER I.F. CAL	Immediately triggers an I.F. calibration, which calibrates the internal hardware. A "CALIBRATING IF..." message is displayed.	HCT
PRESS <ENTER> TO SELECT OR TURN ON/OFF	Pressing the Enter key implements your menu selection.	None

*Menu TRIG, Triggers Measurement*

MENU	DESCRIPTION	GPIB COMMAND
SELECT UTILITY FUNCTION OPTIONS		None
GPIB ADDRESSES	Calls menu GP7, which displays the current GPIB addresses of the various dedicated instruments.	None
NETWORK SETUP	Calls menu GP8, which lets you select a network protocol. You can use FTP, National Instruments NI-VISA, WINSOCK, and TC[IP-capable CAPVNA, VNAFTP, and other VNAUTILS.	None
DISPLAY INSTRUMENT STATE PARAMS	Calls menu U2, which lets you display the various instrument state parameters.	None
GENERAL DISK UTILITIES	Calls menu DSK1-FD, which lets you select between several disk utilities.	None
CAL COMPONENT UTILITIES	Calls menu U3, which lets you select between several calibration-component utilities.	None
AUTOCAL UTILITIES	Calls menu ACAL_UTIL, which lets you select various AutoCal utilities.	None
COLOR CONFIGURATION	Calls menu U5, which lets you configure the screen colors.	None
DATA ON (OFF) DRAWING	Turns data drawing on or off for all channels.	DD1; DD0; DD1?
BLANKING FREQUENCY INFORMATION	Blanks all frequency-identifier information from the 37XXXD displays, if such information is presently being displayed. Hides the frequency value with X's, such as XXX.XXXXXXXXXX GHz.	FOF; FON; FOX?
SET DATE/TIME	Lets users set the date and time.	None
PRESS <ENTER> TO SELECT OR TURN ON/OFF	Pressing the Enter key implements your menu selection.	None

*Menu U1, Utility Menu*

MENU	DESCRIPTION	GPIB COMMAND
DISPLAY INSTRUMENT STATE PARAMETERS		None
SYSTEM	Displays all of the system parameters (Readout Text for U2, on the following pages).	DGS
CALIBRATION	Displays the calibration parameters.	DCP
OPERATING	Displays the global operating parameters.	DFP
CHANNEL 1 & 2	Displays the Channel 1-2 operating parameters.	DC1
CHANNEL 3 & 4	Displays the Channel 3-4 operating parameters.	DC3
NEXT PARAM PAGE	Alternately displays Readout Text U3 a through e.	
PRESS <ENTER> TO SELECT	Pressing the Enter key implements your menu selection.	None

*Menu U2, Display Instrument State*

*Readout Text U2, Global Operating Parameters*

Parameter	Display Format
Number of Points	
Power Control	xx.x dB
Port 1 Attenuation	xx.x dB
Port 2 Attenuation	xx.x dB
Source 2 Power	xx.x dB
Reference Impedance	xx.xxx Ω
Averaging	xxx Meas. per point
Smoothing	Off/On x.x percent of sweep Off/On

*Readout Text U2, Channel Parameters*

Parameter	Display Format
Number of Points	
Power Control	xx.x dB
Port 1 Attenuation	xx.x dB
Port 2 Attenuation	xx.x dB
Source 2 Power	xx.x dB
Reference Impedance	xx.xxx Ω
Averaging	xxx Meas. per point
Smoothing	Off/On x.x percent of sweep Off/On

*Readout Text U2, System Parameters*

Parameter	Display Format
<i>Model</i>	xxxxxxxx
<i>Serial Number</i>	xxx
<i>Software Version</i>	xxxxxxxx
<i>Options</i>	xxxxxxxx
<i>IEEE 488.2 GPIB Interface</i>	
Address	xx
Enable Registers	xx
Service Request	xx
Standard Event Status	
Parallel Poll	
Extended Event Status	
Limits Testing Status	
<i>Dedicated GPIB Interface</i>	
External Source 1 Address	xxxxx
External Source 2 Address	xxxxx
Plotter Address	xxxxx
Power Meter Address	xxxxx
Frequency Counter	xxxxx
<i>Measurement Trigger</i>	xxxxxx
<i>Automatic I.F. Calibration</i>	xxxxxxxx
<i>Diagnostic Mode</i>	
Troubleshooting	xxx
Receiver Mode	xxxxxxxxxxxx
Search for Lock	xxx

*Readout Text U2, Calibration Parameters*

Parameter	Display Format
Cal Method	xxxxxxxx
Line Type Medium	xxxxxxxx
Cal Type	xxxxxxxx
Number of Points	xxxxxxxx
Start Freq	xxxxxxxx
Stop Freq	xxxxxxxx
Power Control	xx.x dB
Port 1 Attenuator	xx.x dB
Port 2 Attenuator	xx.x dB
Source 2 Power	xx.x dB
Load Type	xxxxxxxx
Through Offset	xxxxxxxx



MENU	DESCRIPTION	GPIB COMMAND
CALIBRATION COMPONENT UTILITIES		None
INSTALL KIT INFORMATION FROM FLOPPY DISK	Reads into memory the coefficient data from the calibration-components disk supplied with the calibration kits.	LKT
DISPLAY COAXIAL OPEN & SHORT INFORMATION	Calls menu U4 and U4A, which lets you display the connector information for the various coaxial connectors supported.	None
DISPLAY COAXIAL OFFSET SHORT INFORMATION	Calls menu U4B, which lets you display the connector information for the various coaxial connectors supported.	None
DISPLAY WAVEGUIDE INFORMATION	Displays the waveguide information loaded from the floppy diskette.	DWG
PRESS <ENTER> TO SELECT	Pressing the Enter key implements your menu selection.	None

*Menu U3, Calibration Component Utilities*

<p>SSLT AND SSST WAVEGUIDE PARAMETERS</p>	
IDENTIFIER	NOT INSTALLED
CUTOFF FREQUENCY	XXX.XXXXXX GHz
OFFSET LENGTH OF SHORT 1	+XXX.XXXX mm
OFFSET LENGTH OF SHORT 2	+XXX.XXXX mm
OFFSET LENGTH OF SHORT 3	+XXX.XXXX mm

*Menu EXT\_U3, SSLT and SSST Waveguide Parameters*

MENU	DESCRIPTION	GPIB COMMAND
DISPLAY INSTALLED OPEN & SHORT TEST PORT CONNECTOR INFO	This menu lets you view coefficient data on components. The data appears in the display area of the screen (See readout text on next page).	None
K – CONN (M)	Select to display coefficient data for the K Connector male components.	DMK
K – CONN (F)	Select to display coefficient data for the K Connector female male components.	DFK
V-CONN (M)	Select to display coefficient data for the V Connector male components.	DMV
V-CONN (F)	Select to display coefficient data for the V Connector female components.	DFV
W1-CONN (M)	Select to display coefficient data for the W1 Connector male components.	DM1
W1-CONN (F)	Select to display coefficient data for the W1 Connector female components.	DF1
SMA (M)	Select to display coefficient data for the SMA male components.	DMS
SMA (F)	Select to display coefficient data for the SMA female components.	DFS
GPC - 3.5 (M)	Select to display coefficient data for the GPC-3.5 male components.	DM3
GPC - 3.5 (F)	Select to display coefficient data for the GPC-3.5 female components.	DF3
GPC - 7	Select to display coefficient data for the sexless GPC-7 components.	DG7
NEXT CONNECTOR	Cycles through selections SMA (M) to GPC 7.	None
MORE CONNECTORS	Calls up menu U4A and lets you select more connectors.	None
PREVIOUS MENU	Displays menu U3.	None
PRESS <ENTER> TO SELECT	Pressing the Enter key implements your menu selection.	None

*Menu U4, Display Installed Calibration Components Information 1*

**SOLT CALIBRATION KIT**

TEST PORT: W1-CONN (MALE)  
CALIBRATION COMPONENTS: W1-CONN (FEMALE)

**OPEN DEVICE**

C0 [e-15 F] +XXXX.XXXX  
C1 [e-27 F/Hz] +XXXX.XXXX  
C2 [e-36 F/Hz<sup>2</sup>] +XXXX.XXXX  
C3 [e-45 F/Hz<sup>3</sup>] +XXXX.XXXX  
OFFSET LENGTH +XXX.XXXX mm  
SERIAL NUMBER "NNNNNN"

**SHORT DEVICE**

L0 [e-12 H] +XXXX.XXXX  
L1 [e-24 H/Hz] +XXXX.XXXX  
L2 [e-33 H/Hz<sup>2</sup>] +XXXX.XXXX  
L3 [e-42 H/Hz<sup>3</sup>] +XXXX.XXXX  
OFFSET LENGTH +XXX.XXXX mm  
SERIAL NUMBER "NNNNNN"

*Menu EXT\_U4, SOLT Calibration Kit Information*

MENU	DESCRIPTION	GPIB COMMAND
DISPLAY INSTALLED OPEN & SHORT TEST PORT CONNECTOR INFO	This menu lets you view coefficient data for connectors. The data appears in the display area of the screen.	None
TYPE N (M)	Select to display coefficient data for the Type N male components.	DMN
TYPE N (F)	Select to display coefficient data for the Type N female components.	DFN
TYPE N (M) 75Ω	Select to display coefficient data for the Type N male 75Ω components.	DMN75
TYPE N (F) 75Ω	Select to display coefficient data for the Type N female 75Ω components.	DFN75
7/16 (M)	Select to display coefficient data for the 7/16 male components.	DM7
7/16 (F)	Select to display coefficient data for the 7/16 female male components.	DF7
TNC (M)	Select to display coefficient data for the TNC male components.	DMT
TNC (F)	Select to display coefficient data for the TNC female male components.	DFT
2.4 mm (M)	Select to display coefficient data for the 2.4 mm male components.	DM2
2.4 mm (F)	Select to display coefficient data for the 2.4 mm female components.	DF2
NEXT CONNECTOR	Cycles through selections V Connector to SPECIAL.	None
MORE CONNECTORS	Calls up menu U4A and lets you select more connectors.	None
PREVIOUS MENU	Returns you to menu U3.	None
PRESS <ENTER> TO SELECT	Pressing the Enter key implements your menu selection.	None

*Menu U4A, Display Installed Calibration Components Information 2*

MENU	DESCRIPTION	GPIB COMMAND
DISPLAY INSTALLED OFFSET SHORT TEST PORT CONNECTOR INFO	This menu lets you view coefficient data for connectors. The data appears in the display area of the screen.	None
W1-CONN (M)	Select to display coefficient data for the W1 Connector male components.	DOM1
W1-CONN (F)	Select to display coefficient data for the W1 Connector female components.	DOF1
SPECIAL A (M)	Select to display coefficient data for special A male components.	DOASM
SPECIAL A (F)	Select to display coefficient data for special A female components.	DOASF
SPECIAL B (M)	Select to display coefficient data for special B male components.	DOBSM
SPECIAL B (F)	Select to display coefficient data for special B female components.	DOBSF
SPECIAL C (M)	Select to display coefficient data for special C male components.	DOCSM
SPECIAL C (F)	Select to display coefficient data for special C female components.	DOCSF
NEXT CONNECTOR	Cycles through selections W Connector to SPECIAL.	None
PREVIOUS MENU	Returns you to menu U3.	None
PRESS <ENTER> TO SELECT	Pressing the Enter key implements your menu selection.	None

*Menu U4B, Display Installed Calibration Components Information 3*

## SSLT AND SSST CALIBRATION KIT

TEST PORT:	W1-CONN (MALE)
CALIBRATION COMPONENTS:	W1-CONN (FEMALE)
OFFSET SHORT 1 DEVICE	
L0 [e-12 H]	+XXXX.XXXX
L1 [e-24 H/Hz]	+XXXX.XXXX
L2 [e-33 H/Hz <sup>2</sup> ]	+XXXX.XXXX
L3 [e-42 H/Hz <sup>3</sup> ]	+XXXX.XXXX
OFFSET LENGTH	+XXX.XXXX mm
SERIAL NUMBER	"NNNNNN"
OFFSET SHORT 2 DEVICE	
L0 [e-12 H]	+XXXX.XXXX
L1 [e-24 H/Hz]	+XXXX.XXXX
L2 [e-33 H/Hz <sup>2</sup> ]	+XXXX.XXXX
L3 [e-42 H/Hz <sup>3</sup> ]	+XXXX.XXXX
OFFSET LENGTH	+XXX.XXXX mm
SERIAL NUMBER	"NNNNNN"
OFFSET SHORT 3 DEVICE	
L0 [e-12 H]	+XXXX.XXXX
L1 [e-24 H/Hz]	+XXXX.XXXX
L2 [e-33 H/Hz <sup>2</sup> ]	+XXXX.XXXX
L3 [e-42 H/Hz <sup>3</sup> ]	+XXXX.XXXX
OFFSET LENGTH	+XXX.XXXX mm
SERIAL NUMBER	"NNNNNN"

Menu EXT\_U4B, SSLT and SSST Calibration Kit Information

MENU	DESCRIPTION	GPIB COMMAND
COLOR CONFIGURATION		None
DATA 10 RED	Sets the color for the data drawn on the display. Use rotary knob to cycle between the available colors. Default color is shown.	DATCOL; DATCOL?
OVERLAY DATA 15 YELLOW	Sets the color for the overlay data drawn on the display. Use rotary knob to cycle between the available colors. Default color is shown.	LAYCOL; LAYCOL?
MEMORY DATA 24 GREEN	Sets the color for the memory data drawn on the display. Use rotary knob to cycle between the available colors. Default color is shown.	TRCCOL; TRCCOL?
MARKERS AND LIMITS 32 CYAN	Sets the color for the markers and limits drawn on the display. Use rotary knob to cycle between the available colors. Default color is shown.	MKRCOL; MKRCOL?
GRATICULE 24 GREEN	Sets the color for the display graticule. Use rotary knob to cycle between the available colors. Default color is shown.	GRTCOL; GRTCOL?
ANNOTATION AND MENU TEXT 24 GREEN	Sets the color for the annotation and menu text. Use rotary knob to cycle between the available colors. Default color is shown.	ANNCOL; ANNCOL?
MENU HEADERS (TITLES & INFO) 32 CYAN	Sets the color for the menu headers and information. Use rotary knob to cycle between the available colors. Default color is shown.	MNUCOL; MNUCOL?
BACKGROUND 0 BLANK	Sets the color for the background. Use rotary knob to cycle between the available colors. Default color is shown.	BCKCOL; BCKCOL?
RESET COLORS	Resets colors to the default values.	RSTCOL
COLOR SCHEMES	Calls menu U5A	None
PRESS <ENTER> TO SELECT	Pressing the Enter key implements your menu selection.	None

*Menu U5, Color Configuration*

MENU	DESCRIPTION	GPIB COMMAND
COLOR SCHEMES	The user can select various color configurations by choosing between predetermined schemes	
RESET COLORS	Loads the current color configuration with the reset (default) colors	RSTCOL
NEW COLORS	Loads the color configuration with the new colors for the "C" models.	NEWCO
CLASSIC COLORS	Loads the color configuration with the classic colors used in past models.	CLASS
INVERSE COLORS	Loads the color configuration with the colors pre-defined for a white background.	INVER
BRILLIANT COLORS	Loads the color configuration with a pre-defined color set.	BRILL
SOFT COLORS	Loads the color configuration with a pre-defined color set.	SOFTCO
TO CUSTOMIZE, SELECT A COLOR SCHEME AND/OR MODIFY THE COLOR CONFIG, THEN STORE AS RESET	The user may also store the current color configuration as the reset colors used in <default>. Only <default-0> will restore the colors to the CLASSIC or NEW ("C" Models) setup.	None
STORE COLOR CONFIG AS RESET (DEFAULT) COLORS	Stores the current color configuration as the reset colors used in <default> and as the reset color scheme.	STOCO
PREVIOUS MENU	Returns you to menu U3.	None
PRESS <ENTER> TO SELECT	Pressing the Enter key implements your menu selection.	None

*Menu U5, Color Configuration*



MENU	DESCRIPTION	GPIB COMMAND
SET DATE/TIME		None
YEAR XXXX	Sets the year.	DATE; DATE?
MONTH XX	Sets the month.	DATE; DATE?
DAY XX	Sets the day.	DATE; DATE?
HOUR XX	Sets the hour.	TIME; TIME?
MINUTE XX	Sets the minute.	TIME; TIME?
DONE, (SET DATE/TIME)	Prompts to set a new time.	None
PREVIOUS MENU (DATE/TIME NOT SET)	Returns to the previous menu.	None
PRESS <ENTER> TO SELECT	Pressing the Enter key implements your menu selection.	None

*Menu U6, Set Date/Time*



# ***Appendix B***

## ***Rear Panel Connectors***

### ***Table of Contents***

---

B-1	INTRODUCTION . . . . .	B-3
B-2	REAR PANEL . . . . .	B-3
B-3	CONNECTOR PINOUT DIAGRAMS. . . . .	B-3



# ***Appendix B***

## ***Rear Panel Connectors***

### ***B-1 INTRODUCTION***

This appendix provides descriptions and pinout diagrams for the 37XXXD rear panel connectors .

### ***B-2 REAR PANEL***

The 37XXXD rear panel connectors are described if Figures B-1 and B-2 on page B-2 and B-3.

### ***B-3 CONNECTOR PINOUT DIAGRAMS***

Figures B-3 through B-10 provide pinout diagrams for the rear panel connectors.

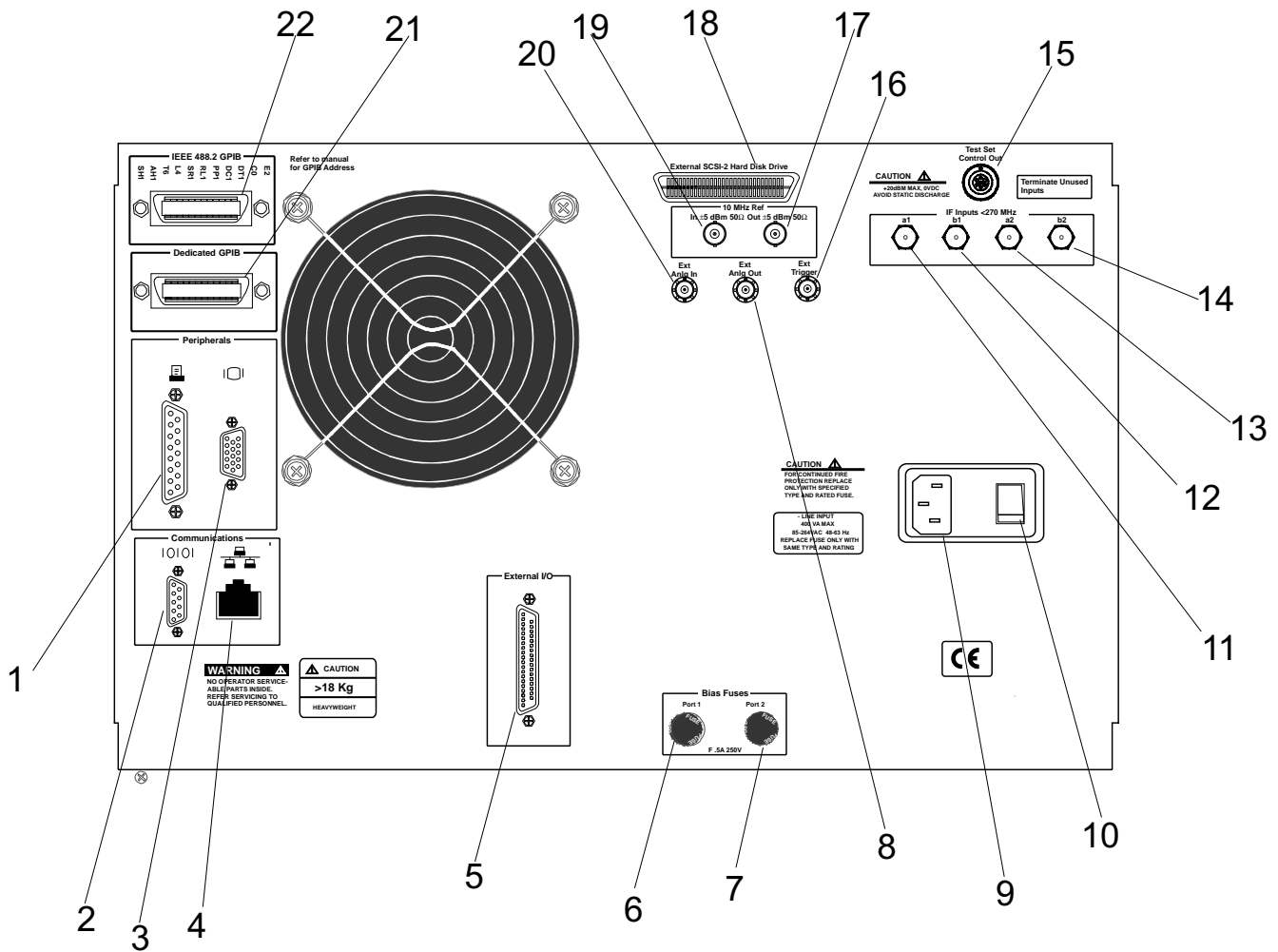
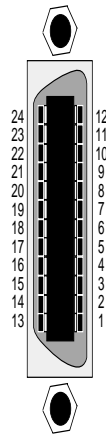


Figure B-1. 372XXD, 373XXD Rear Panel

1. **Printer Out:** 25-pin connector that provides a parallel interface to the companion printer. Figure B-3 describes the signal lines and shows the connector pinout.
2. **Serial:** 9-pin connector provides provides control for AutoCal module. Figure B-5 provides a pinout diagram.
3. **VGA OUT:** 15-pin connector provides VGA output of 37XXXD video display. Figure B-4 provides a pinout diagram.
4. **Ethernet:** RJ45 jack allows connection to a Local Area Network (LAN) for remote programming and data extraction.
5. **External I/O:** Provide I/O access for Channel 1 through 4 limit and Port 1 and 2 bias voltages. Figure B-3 provides a pinout diagram.
6. **Bias Fuses, Port 1:** Fuse, 0.5A, 3AG, 250V, provides protection for external bias being applied to the active device connected to test port 1 without disturbing the accuracy of the 37XXXD measurement.
7. **Bias Fuses, Port 2:** Fuse, 0.5A, 3AG, 250V, provides protection for external bias being applied to the active device connected to test port 2 without disturbing the accuracy of the 37XXXD measurement.
8. **External Anlg Out:** Provides up to a  $\pm 10V$  signal for use in driving an external plotter or antenna (CW draw).
9. **Line Voltage Input:** Three-prong ac plug that provides input for the input-line power. The line voltage must be between 85 and 264 Vac rms, 43 to 63 Hz.
10. **Power On/Off:** Turns the line power on or off.
10. **(Option 12) a1:** IF input from 3738A Broadband Test Set. SMA connector that should be terminated (on chain) when not in use.
12. **(Option 12) b1:** IF input from 3738A Broadband Test Set. SMA connector that should be terminated (on chain) when not in use.
13. **(Option 12) a2:** IF input from 3738A Broadband Test Set. SMA connector that should be terminated (on chain) when not in use.
14. **(Option 12) b2:** IF input from 3738A Broadband Test Set. SMA connector that should be terminated (on chain) when not in use.
15. **(Option 12) Test Set Control Out:** Provides control for 3738A Broadband Test Set. Figure B-6 provides a pinout diagram. TTL levels.
16. **External Trigger:** Allows an external TTL signal to sync the 37XXXD measurements; 10 k $\Omega$  input impedance, BNC female.
17. **10 MHz Ref OUT 0dBm 50 $\Omega$ :** BNC connector that allows the internal 10 MHz reference to be used to phase lock an external counter or other measuring instrument. Level is typically 0 dBm into 50 $\Omega$  impedance.
18. **External SCSI-2 Hard Disk Drive:** Provides for connecting an external SCSI-2 hard disk drive (Option 4). Figure B-7 provides a pinout diagram.
19. **10 MHz Ref IN 0dBm 50 $\Omega$ :** BNC connector that allows an external 10 MHz signal ( $-5$  to  $+5$  dBm) to be used as the frequency reference for phase locking the source frequency. 50 $\Omega$  impedance.
20. **Ext Anlg In:** Provides input to the A5 A/D Converter PCB. BNC connector allows an external dc voltage to be measured by the internal analog-to-digital converter circuit.
21. **Dedicated GPIB:** IEEE 488 standard 24-pin connector that allows the 37XXXD to remotely control a 2nd frequency source, an external plotter, analyzer, or other peripheral. Figure B-2 provides a pinout diagram.
22. **IEEE 488.2 GPIB:** IEEE 488 standard 24-pin connector that provides for remotely controlling the 37XXXD from an external computer/controller via the IEEE-488 bus (GPIB). Figure B-2 provides a pinout diagram.

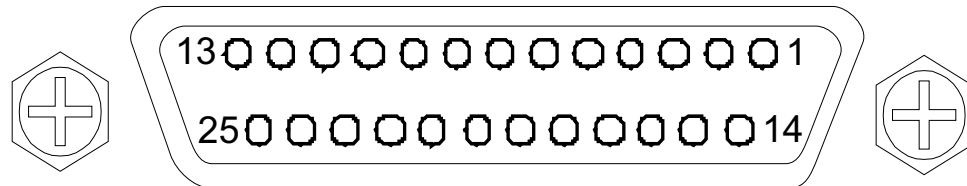


**Pinout Diagram**

PIN	NAME	DESCRIPTION
1-4	DIO 1 through DIO 4	Data Input/Output. Bits are HIGH with the data is logical 0 and LOW when the data is logical 1.
5	EOI	End Or Identify. A low-true state indicates that the last byte of a multibyte message has been placed on the line.
6	DAV	Data Valid. A low-true state indicates that the talker has (1) sensed that NRFD is LOW, (2) placed a byte of data on the bus, and (3) waited an appropriate length of time for the data to settle.
7	NRFD	Not Ready For Data. A high-true state indicates that valid data has not yet been accepted by a listener.
8	NDAC	Not Data Accepted. A high-false state indicates that the current data byte has been accepted for internal processing by a listener.
9	IFC	Interface Clear. A low-true state places all bus instruments in a known state—such as, unaddressed to talk, unaddressed to listen, and service request idle.
10	SRQ	Service Request. A low-true state indicates that a bus instrument needs service from the controller.
11	ATN	Attention. A low-true state enables the controller to respond to both it's own listen/talk address and to appropriate interface messages — such as, device clear and serial poll.
12	Shield	Chassis ground.
13-16	DIO 5 through DIO 8	Data Input/Output. Bits are high with the data is logical 0 and LOW when the data is logical 1.
17	REN	Remote Enable. A low-true state enables bus instruments to be operated remotely, when addressed.
18-		
24	GND	Logic ground.

**Figure B-2.** Pinout Diagram, GPIB and Dedicated GPIB Connectors

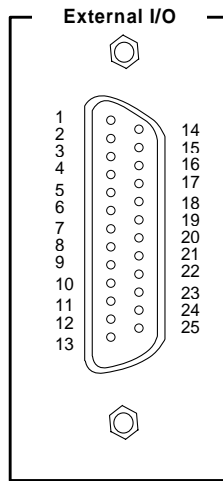




**Pinout Diagram**

PIN	NAME	DESCRIPTION
1	$\overline{\text{STROBE}}$	<i>Printer Strobe.</i> A low-true pulse that tells the printer valid data has been placed on the bus.
2-9	DATA 1 thru DATA 8	<i>Data Lines.</i> Bits are HIGH when the data is logical 1 and LOW when the data is logical 0.
10	$\overline{\text{ACK NLG}}$	<i>Printer Acknowledgment.</i> A low-true (it varies from printer to printer) pulse sent back by the printer to acknowledge that the data has been accepted and the printer is ready to accept more data.
11	BUSY	<i>Printer Busy.</i> High-true level sent by the printer to indicate that it is not available. This line is HIGH at the following times: (1) During data entry. (2) While printing. (3) When off-line. (4) When a printer-error has been signaled.
12	PE	<i>Printer Error.</i> High-true level sent by the printer to indicate that it is out of paper.
13	SLCT	<i>Select.</i> A high-true logic level.
14	$\overline{\text{AUTO FEED XT}}$	<i>Automatic Paper Feed.</i> A low-true level that tells the printer to feed the paper automatically.
15	$\overline{\text{ERR}}$	<i>Printer Error.</i> A low-true signal that indicates the printer is (1) out of paper, (2) off-line, or (3) in an error state.
16	$\overline{\text{INIT}}$	<i>Printer Initial State.</i> A low-true pulse that tells the printer to assume its initial state and clear its print buffer.
17	$\overline{\text{SLCT IN}}$	<i>Printer Select Input.</i> A low-true level that permits the printer to accept data.
18-25	DATA RTN	Return lines for DATA 1 thru DATA 8 lines.

**Figure B-3.** Pinout Diagram, Printer Connector (1 of 2)



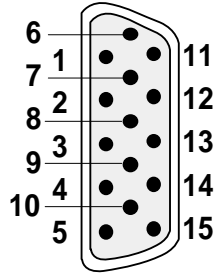
**Pinout Diagram**

PIN	NAME	DESCRIPTION
1	Channel 1 Limit	Signal indicating results of Channel 1 limit testing. User selectable TTL-high = Fail or TTL-low = Fail.
2	Limit 1 Rtn	Return for the Channel 1 limit signal
3	Channel 2 Limit	Signal indicating results of Channel 2 limit testing. User selectable TTL-high = Fail or TTL-low = Fail.
4	Limit 2 Rtn	Return for the Channel 1 limit signal
5	Channel 3 Limit	Signal indicating results of Channel 3 limit testing. User selectable TTL-high = Fail or TTL-low = Fail.
6	Limit 3 Rtn	Return for the Channel 3 limit signal
7	Channel 4Limit	Signal indicating results of Channel 4 limit testing. User selectable TTL-high = Fail or TTL-low = Fail. Pins 7 is also used as the TTL handshake for external trigger mode. TTL-high = VNA has completed a measurement and is ready for another trigger
8	Limit 4 Rtn	Return for the Channel 4 limit signal or VNA measurement complete signal. Pin 8 is also the return for pin 7.
9	Limit Fail	Signal indicating failure in any channel limit testing. User selectable TTL-high = Fail or TTL-low = Fail.
10	Spare	
11	Spare	
12	Limit Fail Rtn	Return for the Limit Fail signal
13	Spare	
14	Spare	
15	Ext Dig In	Allows an external signal to sync the 37XXXD measurements; TTL level
16	Dig In Rtn	Return for External Dig In signal

**Figure B-5.** Pinout Diagram, External I/O Connector (1 of 2)

<b>PIN</b>	<b>NAME</b>	<b>DESCRIPTION</b>
17	Ext Ana Out	Provides an up-to-±10V signal for use in driving an external plotter or antenna (CW draw).
18	Ana Out Rtn	Return for Ext Ana Out signal
19	Spare	
20	Spare	
21	Spare	
22	Gnd 1	Return for Port 1 Bias.
23	Port 1 Bias	Provides for applying an external bias to the active device connected to test port 1.
24	Port 2 Bias	Provides for applying an external bias to the active device connected to test port 2.
25	Gnd 2	Return for Port 2 Bias.

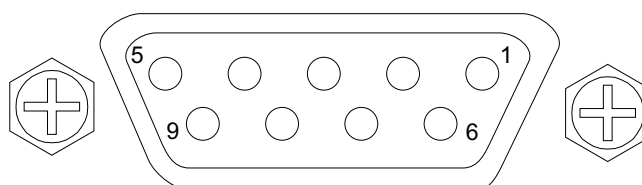
**Figure B-3.** Pinout Diagram, External I/O Connector (2 of 2)



*Pinout Diagram*

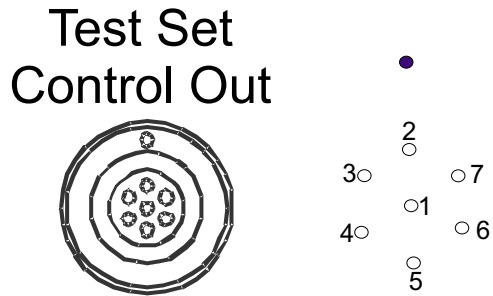
PIN	NAME	DESCRIPTION
1	Red	Red signal
2	Green	Green signal
3	Blue	Blue signal
4	Not Used	
5	Not Used	
6	Red Return	Red return
7	Green Return	Green return
8	Blue Return	Blue return
9	Not Used	
10	Digital Ground	Sync ground
11	Not Used	
12	Not Used	
13	Hsync	Horizontal sync
14	Vsync	Vertical sync
15	Not Used	

**Figure B-4.** Pinout Diagram, VGA IN/OUT Connector



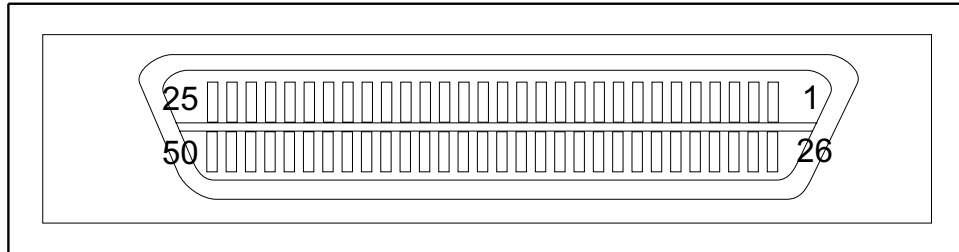
PIN	DESCRIPTION
1	CD
2	RXD
3	TXD
4	DTR
5	N.C.
6	N.C.
7	RTS
8	CTS
9	N.C.

**Figure B-5.** Pinout Diagram, Serial Port Connector



PIN	NAME	DESCRIPTION
1	Ground	Ground return
2	N/C	No connection
3	H Coax/L mm	HIGH <65 GHz, LOW >65 GHz
4	N/C	No connection
5	L Reverse	LOW reverse sweep, HIGH forward sweep
6	N/C	No connection
7	L Forward	LOW forward sweep, HIGH reverse sweep

**Figure B-6.** Pinout Diagram, Test Set Control Out Connector (Option 12)



PIN	DESCRIPTION	PIN	DESCRIPTION
1 thru 25	GND	38	Termination Power
26	DATA 1	39	N.C.
27	DATA 2	40	GND
28	DATA 3	41	$\overline{\text{ATN}}$
29	DATA 4	42	GND
30	DATA 5	43	$\overline{\text{BSY}}$
31	DATA 6	44	$\overline{\text{ACK}}$
32	DATA 7	45	$\overline{\text{RST}}$
33	DATA 8	46	$\overline{\text{MSG}}$
34	Data Parity	47	$\overline{\text{SEL}}$
35	GND	48	$\overline{\text{CD}}$
36	GND	49	$\overline{\text{REQ}}$
37	N.C.	50	$\overline{\text{I/O}}$

**Figure B-7.** Pinout Diagram, External SCSI-2 (Optional)





# ***Appendix C***

## ***Performance Specifications***

This appendix contains a copy of the 37000D Vector Network Analyzers Technical Data Sheet, Anritsu Part Number 11410-00350.



**Index**

**!**

3 dB Compressed Smith Chart Display Mode . 6-10  
40 MHz to 65 GHz Checkout . . . . . 14-12

**A**

Active Channel Selection . . . . . 6-13  
Active Device Measurements . . . . . 8-24 to 8-28  
    Discussion . . . . . 8-24 to 8-28  
Adapter Removal Measurements  
    Discussion . . . . . 8-34 to 8-38  
Address, GPIB . . . . . 2-7  
Analog Instrument Status . . . . . 6-12  
Analyzer Module . . . . . 3-4  
Apply Cal Key . . . . . 4-4,4-10  
Arrow Key . . . . . 4-9  
Autoscale Key . . . . . 4-6,4-25  
Average Key . . . . . 4-7  
Avg/Smooth Key . . . . . 4-7  
Avg/Smooth Menu Key . . . . . 4-29

**B**

Bandpass Impulse Response . . . . . 9-5  
Beatty Standard . . . . . 1-12  
Begin Cal Key . . . . . 4-4,4-10  
Bias Input Connectors . . . . . 4-6  
Broadband Calibration . . . . . 14-16  
    Merging Calibrations . . . . . 14-16  
Broadband Measurement System . . . . . 14-3  
Broadband Menus, Flow . . . . . 14-15

**C**

Cable Length Restrictions . . . . . 2-6  
Cables . . . . . 14-4  
CAD System . . . . . 8-28  
Calibrating for a Measurement . . . . . 7-9  
Calibration  
    See Measurement Calibration  
Calibration Key-Group Description . . 4-10 to 4-19  
Calibration Keys . . . . . 4-4,4-10 to 4-19  
Calibration Kits  
    3650 . . . . . 1-5

3651 . . . . . 1-6  
3652 . . . . . 1-7  
3653 . . . . . 1-8 to 1-9  
3656 . . . . . 1-10  
3657 . . . . . 1-11  
Contents . . . . . 12-3  
Model 3650 . . . . . 12-4  
Model 3651 . . . . . 12-5  
Model 3652 . . . . . 12-6  
Model 3653 . . . . . 12-7  
Model 3654/3654B . . . . . 12-8  
Model 3656 . . . . . 12-9  
Model 3657 . . . . . 12-10  
    Purpose . . . . . 12-3  
Calibration Sequence . . . . . 4-10  
Ch 1 Key . . . . . 4-8  
Ch 2 Key . . . . . 4-8  
Ch 3 Key . . . . . 4-8  
Ch 4 Key . . . . . 4-8  
Ch1 - Ch4 Keys . . . . . 4-24  
Channel Menu Key . . . . . 4-8,4-24  
Channels Key-Group . . . . . 4-24  
Channels Keys . . . . . 4-8  
Cleaning Connectors . . . . . 12-13  
Connector Pin Depth . . . . . 12-11  
Connector Pin Depth Tolerance . . . . . 12-12  
Connectors, Cleaning . . . . . 12-13  
Console and Table Setup . . . . . 13-7,14-6  
Copying Data Files . . . . . 4-41

**D**

Data Display  
    Active Channel Selection . . . . . 6-13  
    Analog Instrument Status . . . . . 6-12  
    Control . . . . . 6-13 to 6-14  
    Frequency Range . . . . . 6-12  
    Limits . . . . . 6-11  
    Linear Phase . . . . . 3-9  
    Log Magnitude . . . . . 3-9  
    Markers . . . . . 6-14  
    Measurement Status . . . . . 6-13  
    Plotter Output . . . . . 6-15  
    Polar . . . . . 3-10  
    Reference Position Marker . . . . . 6-12  
    Scale Resolution . . . . . 6-12

Screen-Image Printout . . . . . 6-15

Smith . . . . . 3-10

S-parameter Selection . . . . . 6-14

Status . . . . . 6-12

Sweep Marker Indicator . . . . . 6-13

Tabular Printout . . . . . 6-15

Update . . . . . 6-14

Data Display Modes

  3 dB Compressed Smith Chart . . . . . 6-10

  Dual Channel . . . . . 6-4

  Dual Channel Rectilinear Graticule . . . . . 6-8

  Dual Trace Overlay . . . . . 6-6

  Four Channel . . . . . 6-5

  Graph Data Types . . . . . 6-7

  Linear Polar Graticule. . . . . 6-8

  Log Polar Graticule . . . . . 6-9

  Marker Designation . . . . . 6-11

  Normal Smith Chart. . . . . 6-9

  Single Channel. . . . . 6-3

Data Display Modes and Types . . . . . 6-3 to 6-6

Data Entry Keys . . . . . 4-9

Data Plotting . . . . . 4-31

Data Points Key. . . . . 4-8,4-21

Default Parameters . . . . . 8-3,8-10

Default Program Key . . . . . 4-4,4-33

Default Settings . . . . . 4-34

Device ID Key . . . . . 4-21

Disk Files, Format . . . . . 4-40

Disk Output . . . . . 6-15

Disk Storage Interface . . . . . 4-40 to 4-41

Diskette Drive . . . . . 4-7

Display Key-Group . . . . . 4-25 to 4-28

Display Keys. . . . . 4-6,4-25

Domain Key . . . . . 4-8,4-21

Drive, External SCSI. . . . . 2-4

Dual Channel Display Mode . . . . . 6-4

Dual Channel Rectilinear Display Mode . . . . . 6-8

Dual Source Control

  Pre-operational Setup . . . . . 8-30

Dual Source Control Measurements

  Discussion . . . . . 8-29 to 8-33

Dual Trace Overlay Display Mode . . . . . 6-6

**E**

E/O Measurements . . . . . 8-65

  Equipment Setup . . . . . 8-65

  Measurement Procedure . . . . . 8-66

Enhancement Keys . . . . . 4-7,4-29

Enter Key . . . . . 4-9

Error Messages . . . . . 5-3

Error Modeling and Flowgraphs. . . . . 7-6

Error Terms

  Description . . . . . 3-11

Evaluating the Calibration . . . . . 7-11

External Monitor Connector . . . . . 2-8

External SCSI Drive, Setup . . . . . 2-4

**F**

Four Channel Display Mode . . . . . 6-5

Fourier Transform . . . . . 9-3

Frequency

  Range . . . . . 6-12

Frequency Domain . . . . . 9-3,9-8,9-12

Front Panel

  Calibration Key-Group Description . 4-10 to 4-19

  Channels Key-Group Description . . . . . 4-24

  Display Key-Group Description . . . 4-25 to 4-28

  Key-Group Descriptions . . . . . 4-3 to 4-9

  Markers/Limits Key-Group Description . 4-36 to 4-39

  Measurement Key-Group Description 4-21 to 4-23

  Output Key-Group Description . . . 4-31 to 4-32

  Save/Recall Key, Description . . . . . 4-20

  System State Key-Group Description 4-33 to 4-35

**G**

Gain Compression

  Swept Power Gain Compression Measurement . . . . . 8-43

  Swept Frequency Measurement . . . . . 8-51

Gain Compression Measurements

  Discussion . . . . . 8-39 to 8-57

Gating . . . . . 9-12

General Description . . . . . 3-3 to 3-4

GHz/10E+3/Ms/m Key . . . . . 4-9

GPIO

  Indicators . . . . . 4-3

GPIO Addresses . . . . . 2-7

GPIO Interface to External Plotter . . . . . 2-7

GPIO Setup and Interconnection . . . . . 2-6

Graph Data Types . . . . . 6-7

Graph Type Key. . . . . 4-6,4-25

**H**

Hard Copy  
 Plotter Output . . . . . 6-15  
 Screen-Image Printout . . . . . 6-15  
 Tabular Printout . . . . . 6-15  
 Hard Copy and Disk Output . . . . . 6-15  
 Hard Copy Keys . . . . . 4-5,4-31  
 High Level Noise Test  
 Test Procedure . . . . . 11-7  
 High Level Noises Test . . . . . 11-6  
 Hold Key . . . . . 4-8,4-21

**I**

Identification Number . . . . . 1-3  
 Impulse Response . . . . . 9-4  
 Initial Inspection . . . . . 2-3  
 Initial Setup . . . . . 11-3  
 Insertables . . . . . 7-5  
 Instrument Installation into Console . . . . . 13-8,14-7  
 Interface  
 Connectors . . . . . 2-6  
 Disk Storage . . . . . 4-40 to 4-41  
 Introduction . . . . . 11-3

**K**

Keyboard Connector . . . . . 4-7  
 Keypad . . . . . 4-9  
 Keys  
 Calibration . . . . . 4-10 to 4-19  
 Channel Key-Group . . . . . 4-24  
 Display Key-Group . . . . . 4-25 to 4-28  
 Markers/Limits . . . . . 4-36 to 4-39  
 Markers/Limits Key-Group . . . . . 4-36 to 4-39  
 Measurement Key-Group . . . . . 4-21 to 4-24  
 Output Key-Group . . . . . 4-31 to 4-32  
 Save/Recall Menu . . . . . 4-20  
 System State . . . . . 4-33 to 4-35  
 System State Key-Group . . . . . 4-33 to 4-35  
 kHz/10E-3/ps/mm Key . . . . . 4-9  
 Kit Contents . . . . . 12-3

**L**

Limit Frequency Readout Function . . . . . 4-36  
 Limits . . . . . 6-11

Limits Key . . . . . 4-5,4-36  
 Linear Polar Graticule Display Mode . . . . . 6-8  
 Load Match . . . . . 7-6  
 Log Magnitude Display . . . . . 3-9  
 Log Polar Graticule Display Mode . . . . . 6-9  
 LRL/LRM Calibration Procedure  
 Coaxial . . . . . 7-44  
 General . . . . . 7-36 to 7-45  
 Microstrip . . . . . 7-37  
 Waveguide . . . . . 7-46  
 LRL/LRM Calibration Setup Menu Flow . . . . . 4-15

**M**

Marker  
 Display of . . . . . 6-14  
 Reference Position . . . . . 6-12  
 Marker Designation . . . . . 6-11  
 Marker Menu Key . . . . . 4-5,4-36  
 Markers/Limits Key-Group . . . . . 4-36 to 4-39  
 Markers/Limits Keys . . . . . 4-5,4-36  
 ME7808C . . . . . 14-4  
 Measurement Calibration  
 Calibration Types . . . . . 7-6  
 Discussion . . . . . 7-3 to 7-12  
 Error Modeling and Flowgraphs . . . . . 7-6  
 Evaluating the Calibration . . . . . 7-11  
 LRL/LRM Procedure . . . . . 7-36 to 7-45  
 Offset-Short Procedure . . . . . 7-28 to 7-31  
 Sliding Load, Procedure . . . . . 7-13 to 7-18  
 Standard (SOLT) Procedure . . . . . 7-19 to 7-27  
 Triple Offset-Short Procedure . . . . . 7-32 to 7-35  
 Understanding the Calibration System . . . . . 7-5  
 Measurement Instruments . . . . . 14-4  
 Measurement Key-Group Description . . . . . 4-21 to 4-23  
 Measurement Keys . . . . . 4-8,4-21  
 Measurement Status . . . . . 6-13  
 Measurement Uncertainty . . . . . 7-3  
 Measurements  
 Active Device . . . . . 8-24 to 8-28  
 Adapter Removal . . . . . 8-34 to 8-38  
 Dual Source Control . . . . . 8-29 to 8-33  
 Gain Compression . . . . . 8-39 to 8-57  
 Receiver Mode . . . . . 8-58 to 8-61  
 Time Domain . . . . . 9-3  
 Transmission and Reflection . . . . . 8-3 to 8-11  
 Mechanical Shock . . . . . 12-12  
 Menu Flow  
 Calibration Key-Group Menus . . . . . 4-10 to 4-19

MARKER MENU Key . . . . . 4-36  
 Save/Recall Key. . . . . 4-20  
 Menu Key . . . . . 4-5,4-31  
 Menu Keys . . . . . 4-9  
 Menus  
   Channels Key-Group . . . . . 4-24  
   Display Key-Group . . . . . 4-25 to 4-28  
   Markers/Limits Key-Group . . . . . 4-36 to 4-39  
   Measurement Key-Group . . . . . 4-21 to 4-23  
   Output Key-Group . . . . . 4-31 to 4-32  
   System State Key-Group. . . . . 4-33 to 4-35  
 MHz/X1/ns/cm Key . . . . . 4-9  
 Microwave Load . . . . . 7-13  
 Millimeter Wave Measurements. . . . . 1-4  
 Millimeter Wave System  
   Allowable Measurements and Calibrations 13-17  
   Allowable Module Configurations . . . . . 13-17  
   Calibration . . . . . 13-12  
   Description . . . . . 13-3  
   Effect of Default Program . . . . . 13-18  
   Measurement Capabilities. . . . . 13-5  
   Measurement Procedures. . . . . 13-22  
   Operation . . . . . 13-13  
   Operational Checkout-General. . . . . 13-24  
   Operational Checkout-High Level Noise Test  
   . . . . . 13-27,13-29  
   Operational Checkout-IF Power Level Test 13-25  
   Performance Specifications . . . . . 13-4  
   Remote Operation. . . . . 13-23  
   System Performance . . . . . 13-4  
   Test Port Characteristics . . . . . 13-5  
 Model 3650 Calibration Kit. . . . . 12-4  
 Model 3651 Calibration Kit. . . . . 12-5  
 Model 3652 Calibration Kit. . . . . 12-6  
 Model 3653 Calibration Kit. . . . . 12-7  
 Model 3654/3654B Calibration Kit . . . . . 12-8  
 Model 3656 Calibration Kit. . . . . 12-9  
 Model 3657 Calibration Kit . . . . . 12-10  
 Multiple Source Control  
   Control Formula . . . . . 8-29  
   Operation . . . . . 8-31

**N**

Network Analyzers . . . . . 7-13  
   Basics. . . . . 3-6  
   Description . . . . . 1-3  
   Error Correction . . . . . 3-11  
   Measurements . . . . . 3-9

Options . . . . . 1-16  
 Primer . . . . . 3-5 to 3-11  
 Non-insertables. . . . . 7-5  
 Normal Smith Chart Display Mode . . . . . 6-9

**O**

O/E Measurements . . . . . 8-68  
   Equipment Setup. . . . . 8-68  
   Measurement Procedure . . . . . 8-68  
 Offset-Short Calibration Procedure . . . . . 7-28 to 7-31  
 Offset-Short Calibration Setup Menu Flow . . . . . 4-13  
 Open . . . . . 8-27  
 Operational Checkout  
   High Level Noise Test . . . . . 11-6  
   Initial Setup . . . . . 11-3  
   Required Test Equipment . . . . . 11-3  
   Sampler Efficiency Test . . . . . 11-4  
   Self Test. . . . . 11-3  
 Optical Application . . . . . 8-65 to 8-76  
   E/O Measurements. . . . . 8-65  
   O/E Measurements. . . . . 8-68  
 Option 2 Time Domain  
   Menus. . . . . 9-14 to 9-20  
 Option 2A Time Domain  
   Gating . . . . . 9-12 to 9-13  
   Gating Example . . . . . 9-14  
   Operating . . . . . 9-8  
   Windowing . . . . . 9-11  
 Option 4 External SCSI Drive  
   Requirements . . . . . 2-4  
   Setup . . . . . 2-4  
 Option 5 Receiver Mode  
   Menus. . . . . 8-59  
   Operating Procedure . . . . . 8-60  
   Operation . . . . . 8-59  
   Set-On Mode . . . . . 8-58  
   Sweeper Source Lock Mode . . . . . 8-58  
 Option Menu Key . . . . . 4-7,4-29  
 Options. . . . . 1-16  
 Output Key-Group . . . . . 4-31 to 4-32  
 Over Torquing Connectors. . . . . 12-12

**P**

Performance Specifications . . . . . 1-16  
 Phasor-impulse Response . . . . . 9-5  
 Pin Depth . . . . . 7-13  
 Plotter Output. . . . . 6-15

Plotting . . . . . 4-31  
 Polar Display . . . . . 3-10  
 Port 1 Connector . . . . . 4-6  
 Port 1 Test Connector . . . . . 4-4  
 Port 2 Connector . . . . . 4-6  
 Port 2 Test Connector . . . . . 4-5  
 Preparation for Storage and/or Shipment . . . . . 2-11  
 Preparation for Use. . . . . 2-3  
 Printing  
     Stop/Start. . . . . 4-31  
 Purpose . . . . . 12-3

**R**

Readout Marker key . . . . . 4-5  
 Readout Marker Key . . . . . 4-36  
 Receiver Mode Measurements . . . . . 8-58 to 8-61  
     Operating Procedure . . . . . 8-60  
 Recovering, Disk Write/Read Errors . . . . . 4-41  
 Ref Plane Key . . . . . 4-6,4-25  
 Reference Flat. . . . . 7-15  
 Reference Position Marker . . . . . 6-12  
 Rotary Knob. . . . . 4-9

**S**

S Params Key . . . . . 4-6,4-25  
 S2P File  
     Comment Line . . . . . 8-76  
     Creating. . . . . 8-74  
     Data Line . . . . . 8-75  
     Example. . . . . 8-76  
     File Format . . . . . 8-74  
     Option Line. . . . . 8-75  
 Sampler Efficiency Test. . . . . 11-4  
     Test Setup . . . . . 11-5  
 Save/Recall Menu . . . . . 4-20  
 Save/Recall Menu Key. . . . . 4-4 to 4-5  
 Save/Recall Menu Key . . . . . 4-20  
 Scale Resolution. . . . . 6-12  
 Scattering Parameters . . . . . 3-9  
 Screen-Image Printout . . . . . 6-15  
 SCSI Drive, External. . . . . 2-4  
 Self Test . . . . . 11-3  
 Set Scale Key . . . . . 4-6,4-25  
 Setup Menu Key. . . . . 4-8,4-21  
 Short. . . . . 8-27  
 Single Channel Display Mode . . . . . 6-3  
 Sliding Load . . . . . 7-13

17K50, 17KF50 . . . . . 1-7  
 17S50, 17SF50 . . . . . 1-5  
 Pin Depth. . . . . 7-13  
     Used in Calibrator. . . . . 7-5  
 Smith Chart . . . . . 8-10  
     3 dB Compressed . . . . . 6-10  
     Measurement Discussion . . . . . 8-8  
     Normal . . . . . 6-9  
 Smith Chart Display . . . . . 3-10  
 Source Match . . . . . 7-6  
 Source Module  
     General. . . . . 3-4  
 S-parameter . . . . . 8-25  
     Description. . . . . 3-9 to 3-10  
     General. . . . . 3-9  
     Selection, Display of . . . . . 6-14  
 Specifications, Performance . . . . . 1-16  
 Standard Calibration Setup Menu Flow . . . . . 4-11  
 Start Print Key . . . . . 4-5,4-31  
 Start Printing . . . . . 4-31  
 Status Display. . . . . 6-12  
 Stop Print Key. . . . . 4-5,4-31  
 Stop Printing . . . . . 4-31  
 Sweep Marker Indicator . . . . . 6-13  
 System Cabling. . . . . 13-10,14-9  
 System Description. . . . . 1-3  
 System GPIB Interconnection . . . . . 2-7  
 System State Key-Group . . . . . 4-33 to 4-35  
 System State Keys . . . . . 4-4,4-33

**T**

Tabular Printout . . . . . 6-15  
 Teflon Tuning Washers . . . . . 12-12  
 Test Ports  
     Establishing, Discussion . . . . . 7-3  
 Test Set  
     Reversing . . . . . 3-11  
 Test Set Module  
     General. . . . . 3-4  
 Time Domain Measurements . . . . . 9-3  
 Trace Memory Key . . . . . 4-6,4-26  
 Trace Smooth and Average Keys . . . . . 4-29  
 Trace Smooth Key . . . . . 4-7  
 Tracking. . . . . 7-6  
 Transmission and Reflection Measurements . . . . . 8-3  
     Discussion . . . . . 8-7  
     General. . . . . 8-3 to 8-11  
     Setup and Calibration . . . . . 8-3

Smith Chart . . . . . 8-8  
Triple Offset Short Calibration Procedure . 7-32 to  
7-35  
TRM Calibration Setup Menu Flow . . . . . 4-17

**U**

Using Connectors  
  Mechanical Shock . . . . . 12-12  
  Over Torquing. . . . . 12-12  
  Pin Depth . . . . . 12-11  
  Pin Depth Tolerance . . . . . 12-12  
  Teflon Tuning Washers. . . . . 12-12  
Utility Menu Key . . . . . 4-4,4-33

**V**

Verification Kit

3666 . . . . . 1-12  
3668. . . . . 1-14 to 1-15  
Used in Calibration. . . . . 7-11  
Video IF BW Key . . . . . 4-7,4-29

**W**

Wafer Probe Station . . . . . 14-13 to 14-14  
Windowing. . . . . 9-11

**Z**

Zo Load . . . . . 8-27  
Zo Reference. . . . . 7-13