

---

## Caution

---



Do not exceed the operating input power, voltage, and current level and signal type appropriate for the instrument being used, refer to your instrument's Function Reference.



Electrostatic discharge(ESD) can damage the highly sensitive microcircuits in your instrument. ESD damage is most likely to occur as the test fixtures are being connected or disconnected. Protect them from ESD damage by wearing a grounding strap that provides a high resistance path to ground. Alternatively, ground yourself to discharge any static charge built-up by touching the outer shell of any grounded instrument chassis before touching the test port connectors.

---

## **Safety Summary**

---

When you notice any of the unusual conditions listed below, immediately terminate operation and disconnect the power cable.

Contact your local Agilent Technologies sales representative or authorized service company for repair of the instrument. If you continue to operate without repairing the instrument, there is a potential fire or shock hazard for the operator.

- Instrument operates abnormally.
- Instrument emits abnormal noise, smell, smoke or a spark-like light during operation.
- Instrument generates high temperature or electrical shock during operation.
- Power cable, plug, or receptacle on instrument is damaged.
- Foreign substance or liquid has fallen into the instrument.

---

## **Herstellerbescheinigung**

### GERÄUSCHEMISSION

LpA < 70 dB  
am Arbeitsplatz  
normaler Betrieb  
nach DIN 45635 T. 19

---

## **Manufacturer's Declaration**

### ACOUSTIC NOISE EMISSION

LpA < 70 dB  
operator position  
normal operation  
per ISO 7779

## **Regulatory compliance information**

This product complies with the essential requirements of the following applicable European Directives, and carries the CE marking accordingly:

The Low Voltage Directive 73/23/EEC, amended by 93/68/EEC

The EMC Directive 89/336/EEC, amended by 93/68/EEC

To obtain Declaration of Conformity, please contact your local Agilent Technologies sales office, agent or distributor.

---

---

## Safety notice supplement

---

---

- This equipment complies with EN/IEC61010-1:2001.
- This equipment is MEASUREMENT CATEGORY I (CAT I). Do not use for CAT II, III, or IV.
- Do not connect the measuring terminals to mains.
- This equipment is POLLUTION DEGREE 2, INDOOR USE product.
- This equipment is tested with stand-alone condition or with the combination with the accessories supplied by Agilent Technologies against the requirement of the standards described in the Declaration of Conformity. If it is used as a system component, compliance of related regulations and safety requirements are to be confirmed by the builder of the system.



# **Agilent E4991A RF Impedance/Material Analyzer**

# **Operation Manual**

**Ninth Edition**

## **SERIAL NUMBERS**

This manual applies directly to instruments that have the firmware revision 2.1x and serial number prefix MY433.

For additional important information about firmware revisions and serial numbers, see Appendix A.



**Manufacturing No. E4991-90090**

**June 2012**

---

## Notices

The information contained in this document is subject to change without notice.

This document contains proprietary information that is protected by copyright. All rights are reserved. No part of this document may be photocopied, reproduced, or translated to another language without the prior written consent of the Agilent Technologies.

MS-DOS, Windows, Visual C++, Visual Basic, VBA and Excel are U.S. registered trademarks of Microsoft Corporation.

UNIX is a registered trademark in the United States and other countries, licensed exclusively through X/Open Company Limited.

Portions ©Copyright 2012, Microsoft Corporation. All rights reserved.

© Copyright 2001, 2002 ,2003, 2004, 2005, 2006 , 2012 Agilent Technologies

---

## Manual Printing History

The manual's printing date and part number indicate its current edition. The printing date changes when a new edition is printed (minor corrections and updates that are incorporated at reprint do not cause the date to change). The manual part number changes when extensive technical changes are incorporated.

March 2001	Preliminary (part number: E4991-90000)
April 2001	First Edition (part number: E4991-90010)
July 2001	Second Edition (part number: E4991-90020)
September 2001	Third Edition (part number: E4991-90030)
February 2002	Fourth Edition (part number: E4991-90040)
March 2003	Fifth Edition (part number: E4991-90050)
December 2004	Sixth Edition (part number: E4991-90060)
December 2005	Seventh Edition (part number: E4991-90070)
July 2006	Eighth Edition (part number: E4991-90080)
June 2012	Ninth Edition (part number: E4991-90090)



---

## Safety Summary

The following general safety precautions must be observed during all phases of operation, service, and repair of this instrument. Failure to comply with these precautions or with specific WARNINGS elsewhere in this manual may impair the protection provided by the equipment. Such noncompliance would also violate safety standards of design, manufacture, and intended use of the instrument. Agilent Technologies assumes no liability for the customer's failure to comply with these precautions.

---

### NOTE

The E4991A complies with INSTALLATION CATEGORY II as well as POLLUTION DEGREE 2 in IEC61010-1. The E4991A is an INDOOR USE product.

---

### NOTE

The LEDs in the E4991A are Class 1 in accordance with IEC60825-1, CLASS 1 LED PRODUCT

- Ground the Instrument  
To avoid electric shock, the instrument chassis and cabinet must be grounded with the supplied power cable's grounding prong.
- DO NOT Operate in an Explosive Atmosphere  
Do not operate the instrument in the presence of inflammable gasses or fumes. Operation of any electrical instrument in such an environment clearly constitutes a safety hazard.
- Keep Away from Live Circuits  
Operators must not remove instrument covers. Component replacement and internal adjustments must be made by qualified maintenance personnel. Do not replace components with the power cable connected. Under certain conditions, dangerous voltage levels may remain even after the power cable has been disconnected. To avoid injuries, always disconnect the power and discharge circuits before touching them.
- DO NOT Service or Adjust the Instrument Alone  
Do not attempt internal service or adjustment unless another person, capable of rendering first aid and resuscitation, is present.
- DO NOT Substitute Parts or Modify the Instrument  
To avoid the danger of introducing additional hazards, do not install substitute parts or perform unauthorized modifications to the instrument. Return the instrument to an Agilent Technologies Sales and Service Office for service and repair to ensure that safety features are maintained in operational condition.
- Dangerous Procedure Warnings  
Warnings, such as the example below, precede potentially dangerous procedures throughout this manual. Instructions contained in the warnings must be followed.

---










### WARNING

**Dangerous voltage levels, capable of causing death, are present in this instrument. Use extreme caution when handling, testing, and adjusting this instrument.**

---

## Safety Symbols

General definitions of safety symbols used on the instrument or in manuals are listed below.

-  Instruction Manual symbol: the product is marked with this symbol when it is necessary for the user to refer to the instrument manual.
-  Alternating current.
-  Direct current.
-  On (Supply).
-  Off (Supply).
-  In-position of push-button switch.
-  Out-position of push-button switch.
-  A chassis terminal; a connection to the instrument's chassis, which includes all exposed metal structure.
-  Stand-by.

---

### WARNING

**This warning sign denotes a hazard. It calls attention to a procedure, practice, or condition that, if not correctly performed or adhered to, could result in injury or death to personnel.**

---

### CAUTION

This Caution sign denotes a hazard. It calls attention to a procedure, practice, or condition that, if not correctly performed or adhered to, could result in damage to or destruction of part or all of the instrument.

---

### NOTE

This Note sign denotes important information. It calls attention to a procedure, practice, or condition that is essential for the user to understand.

---

## Certification

Agilent Technologies certifies that this product met its published specifications at the time of shipment from the factory. Agilent Technologies further certifies that its calibration measurements are traceable to the United States National Institute of Standards and Technology, to the extent allowed by the Institution's calibration facility or by the calibration facilities of other International Standards Organization members.

---

## Warranty

This Agilent Technologies instrument product is warranted against defects in material and workmanship for a period of one year from the date of shipment, except that in the case of certain components listed in this manual, the warranty shall be for the specified period. During the warranty period, Agilent Technologies will, at its option, either repair or replace products that prove to be defective.

For warranty service or repair, this product must be returned to a service facility designated by Agilent Technologies. Buyer shall prepay shipping charges to Agilent Technologies, and Agilent Technologies shall pay shipping charges to return the product to Buyer. However, Buyer shall pay all shipping charges, duties, and taxes for products returned to Agilent Technologies from another country.

Agilent Technologies warrants that its software and firmware designated by Agilent Technologies for use with an instrument will execute its programming instruction when properly installed on that instrument. Agilent Technologies does not warrant that the operation of the instrument, or software, or firmware will be uninterrupted or error free.

---

## Limitation of Warranty

The foregoing warranty shall not apply to defects resulting from improper or inadequate maintenance by Buyer, Buyer-supplied software or interfacing, unauthorized modification or misuse, operation outside the environmental specifications for the product, or improper site preparation or maintenance.

---

### IMPORTANT

No other warranty is expressed or implied. Agilent Technologies specifically disclaims the implied warranties of merchantability and fitness for a particular purpose.

---

## Exclusive Remedies

The remedies provided herein are Buyer's sole and exclusive remedies. Agilent Technologies shall not be liable for any direct, indirect, special, incidental, or consequential damages, whether based on contract, tort, or any other legal theory.

---

## Assistance

Product maintenance agreements and other customer assistance agreements are available for Agilent Technologies products.

For any assistance, contact your nearest Agilent Technologies Sales and Service Office. Addresses are provided at the back of this manual.

---

## Typeface Conventions

### **Sample (bold)**

Boldface type is used when a term is defined or emphasis.

### *Sample (Italic)*

Italic type is used for emphasis.

### Sample key

Indicates a hardkey (key on the front panel or external keyboard) labeled “Sample.” “key” may be omitted.

### **Sample** menu/button/box

Indicates a menu/button/box on the screen labeled “Sample” which can be selected/executed by clicking. “menu,” “button,” or “box” may be omitted.

### **Sample** block/toolbar

Indicates a block (group of hardkeys) or a toolbar (setup toolbar) labeled “Sample.”

### **Sample 1 - Sample 2 - Sample 3**

Indicates a sequential operation of **Sample 1**, **Sample 2**, and **Sample 3** (menu, button, or box). “-” may be omitted.

---

## Documentation Map

The following manuals are available for the Agilent E4991A.

- ***Operational Manual (Part Number E4991-900x0, attached to Option ABA)***

This manual describes most of the basic information needed to use the E4991A. It provides a function overview, detailed operation procedure for each function (from preparation for measurement to analysis of measurement results), measurement examples, specifications, and supplemental information. For programming guidance on performing automatic measurement with the E4991A, please see the *Programming Manual*.

- ***Installation and Quick Start Guide (Part Number E4991-902x1, attached to Option ABA)***

This manual describes installation of the instrument after it is delivered and the basic procedures for applications and analysis. Refer to this manual when you use the E4991A for the first time.

- ***Programming Manual (Part Number E4991-900x2, attached to Option ABA)***

This manual provides programming information for performing automatic measurement with the E4991A. It includes an outline of remote control, procedures for detecting measurement start (trigger) and end (sweep end), application programming examples, a command reference, and related information.

---

### NOTE

The number position shown by “x” in the part numbers above indicates the edition number. This convention is applied to each manual, CD-ROM (for manuals), and sample programs disk issued. Here, “0” indicates the initial edition, and each time a revision is made this number is incremented by 1. The latest edition allows the customer to specify Option ABJ (Japanese) or Option ABA (English) of the product.

---

Microsoft®, MS-DOS®, Windows®, and Visual Basic® for Applications are registered trademarks of Microsoft Corporation in U.S. and other countries.

---

## Software Installed

The Windows operating system installed in this machine is customized for more effective operation, and has different functions that are not part of the Windows operating system for ordinary PCs (personal computers). Therefore, do not attempt to use the system in ways other than those described in this manual or to install Windows-based software (including anti-virus software) for ordinary PCs as doing so may cause malfunctions.

Also note the followings.

- Do not update the Windows operating system installed in this machine to the Windows operating system for ordinary PCs. Doing so will cause malfunctions.
- Do not allow any computer virus to infect the system. This machine has no virus check function nor anti-virus software installed.

Agilent Technologies will not be held liable for any failure or damage arising from negligence regarding these prohibitions and warnings.

---

### NOTE

If the pre-installed software is damaged somehow, resulting in errant behavior by the machine, perform a "system recovery".

<b>1. How to Use This Operation Manual</b>	
Relationship of Operation Manual Contents to Using the E4991A . . . . .	20
<b>2. Function Overview</b>	
Names and Functions of Front Panel Blocks . . . . .	22
1. Standby switch . . . . .	23
2. 3.5-inch built-in floppy disk drive. . . . .	23
3. Color LCD display . . . . .	23
4. Measurement block (MEASUREMENT). . . . .	23
5. Stimulus block (STIMULUS). . . . .	24
6. Entry/navigation block (ENTRY/NAVIGATION) . . . . .	25
7. System block (SYSTEM) . . . . .	26
8. Utility key ( key) . . . . .	26
9. Test head interface (TEST HEAD INTERFACE). . . . .	26
Names and Functions of Rear Panel Blocks . . . . .	28
1. Power cable receptacle (-LINE) . . . . .	29
2. LAN port . . . . .	29
3. Printer parallel port (PRINTER, Parallel). . . . .	29
4. External trigger input connector (Ext Trig). . . . .	29
5. External monitor output terminal (VIDEO) . . . . .	29
6. GPIB connector . . . . .	29
7. High stability frequency reference output connector (Ref Oven, Option 1D5 only) . . . . .	29
8. External reference signal input terminal (Ext Ref In, 10 MHz 0 dBm) . . . . .	30
9. Internal reference signal output connector (Int Ref Out) . . . . .	30
10. Unused ports (Reserved). . . . .	30
11. Rear USB port . . . . .	30
12. Mini-DIN mouse port (MOUSE) . . . . .	30
13. Mini-Din keyboard port (KYBD) . . . . .	31
14. Serial number plate . . . . .	31
15. Unused ports (Reserved). . . . .	31
Names and Functions of LCD Display Areas. . . . .	32
1. Title bar . . . . .	32
2. Menu bar . . . . .	32
3. Marker values . . . . .	34
4. Setup toolbar . . . . .	35
5. Trace 1 . . . . .	38
6. Trace 2 . . . . .	38
7. Markers . . . . .	38
8. Scale reference line value . . . . .	38
9. Trace 1 axis . . . . .	38
10. Sweep start value. . . . .	38
11. Sweep stop value. . . . .	38
12. Trace 2 axis . . . . .	38
13. Status bar . . . . .	39
<b>3. Setting Measurement Conditions</b>	
Initialization of E4991A (presetting) . . . . .	42
Setting Material Measurement Parameter (Option 002 only). . . . .	43

---

# Contents

Procedure . . . . .	43
Selection and Confirmation of Target Trace (Active Trace) . . . . .	45
Selecting Active Trace . . . . .	45
Identifying Active Trace . . . . .	45
Selecting Sweep Parameter . . . . .	46
Procedure . . . . .	46
Using Time as Sweep Parameter (Zero Span Sweep) . . . . .	47
Procedure . . . . .	47
Selecting Sweep Type (Linear/Log/Segment) . . . . .	48
Procedure . . . . .	48
Selecting Sweep Direction . . . . .	49
Procedure . . . . .	49
Measurement Waiting Time/Sweep Time Setting . . . . .	50
Procedure . . . . .	51
Setting Sweep Range . . . . .	52
Procedure . . . . .	52
Setting Sweep Area with Marker . . . . .	54
Procedure . . . . .	56
Setting Number of Points (NOP) . . . . .	57
Procedure . . . . .	57
Oscillator Level Setting . . . . .	58
Definition of Oscillator Level Setting . . . . .	58
Procedure . . . . .	59
Setting and Applying dc Bias . . . . .	60
Procedure . . . . .	60
Setting the Trigger Source To Start Sweep . . . . .	61
Procedure . . . . .	61
Selecting Trigger Target (Trigger Event) . . . . .	62
Procedure . . . . .	62
Single Sweep, Continuous Sweep and Sweep Stop . . . . .	63
Procedure . . . . .	63
Selecting Polarity of External Trigger Input Signal . . . . .	64
Procedure . . . . .	64
CW Frequency Setting . . . . .	65
Procedure . . . . .	65
Sweeping a Plural Number of Sweep Areas under Different Conditions at One Time (Segment Sweep) . . . . .	66
Procedure . . . . .	67
Averaging Measurement Results . . . . .	71
Averaging Plural Sweeps (Sweep-to-Sweep Averaging) . . . . .	71
Averaging by Each Measurement Point (Point Averaging) . . . . .	73
<b>4. Calibration and Compensation</b>	
Outline of Calibration and Compensation Functions . . . . .	76
Types of Calibration and Compensation . . . . .	76
Calibration Reference Plane and Calibration Standard . . . . .	77
Calibration/Compensation measurement point mode . . . . .	78
Calibration and Compensation Using 7-mm Test Port as a Calibration Reference Plane . . . . .	81
Calibration using DUT Connecting Terminal as a Calibration Reference Plane . . . . .	83
Calibration of Open/Short/Load/Low-loss Capacitor . . . . .	84



Port Extension Compensation . . . . .	86
Procedure . . . . .	86
Electrical Length Compensation . . . . .	87
Procedure . . . . .	88
Fixture Compensation . . . . .	89
Measuring Fixture Compensation Data . . . . .	89
Switching Fixture Compensation On/Off . . . . .	90
Definition of Calibration/Compensation Kit . . . . .	91
Definition of Calibration Kit . . . . .	91
Definition of Calibration Kit in Permittivity Measurement . . . . .	92
Definition of Compensation Kit . . . . .	92
Restoring Calibration/Compensation Status . . . . .	94
Procedure . . . . .	94

**5. Display Setting**

Setting the Types and Numbers of Display Traces . . . . .	96
Procedure . . . . .	96
Maximize a Display Window on the Screen . . . . .	98
Procedure . . . . .	99
Selecting Measurement Parameter (Impedance Measurement) . . . . .	100
Procedure . . . . .	101
Setting Measurement Parameter (Material Measurement) . . . . .	102
Procedure . . . . .	102
Selecting Graph Coordinate Format . . . . .	104
Procedure . . . . .	105
Autoscale Adjustment . . . . .	107
Autoscale Adjustment for each Trace . . . . .	107
Autoscale Adjustment for all Traces at Once . . . . .	107
Manual Scale Setting . . . . .	108
Scale Setting in Rectangular Coordinates . . . . .	108
Scale Setting on Complex Plane . . . . .	111
Scale Setting in Polar Coordinate Format . . . . .	112
Setting of Reference Line Value by Using Marker . . . . .	112
Zooming a Trace . . . . .	113
Procedure . . . . .	113
Overlay Display and Split Display of Graphs . . . . .	114
Procedure . . . . .	114
Displaying Measurement Values in List Form . . . . .	115
Procedure . . . . .	115
Trace Comparison Using Memory Trace . . . . .	116
Comparison with a stored reference trace . . . . .	116
Subtraction of Offset Value . . . . .	116
Offset Value Setting by Using the Marker . . . . .	117
Selecting Sweep Area Display (Start/Stop or Center/Span) . . . . .	118
Procedure . . . . .	118
Setting Frequency Display Resolution . . . . .	119
Procedure . . . . .	119
Confirm the Setting Status on the Screen . . . . .	120
Procedure . . . . .	121

Continuous Phase Display Without Returning at $\pm 180^\circ$ .....	122
Procedure .....	122
Selecting Phase Unit .....	123
Procedure .....	123
Displaying Trace Title on Measurement Display .....	124
Procedure .....	124
Changing Display Colors .....	126
Procedure .....	126

## 6. Analysis of Measurement Results

Reading Value on the Trace by Specifying Stimulus Value .....	128
Procedure .....	129
Displaying the Values of Plural Points on a Trace in a Value List .....	130
Procedure .....	130
Reading Difference from Reference Point on a Graph (Delta Marker) .....	131
Delta Marker Function .....	131
Procedure .....	133
Reading Only the Actual Measurement Point/Reading the Distance between Measurement Points through Interpolation .....	135
Procedure .....	135
Move the Marker for Each Trace Independently .....	136
Selecting Marker Value Display for Plural Parameters .....	137
Procedure .....	138
Selecting Marker Analysis Target Trace (Data/Memory) .....	139
Procedure .....	139
Search for Max. and Min. Measurement Value .....	140
Procedure .....	140
Search for Target Point of Measurement Value .....	142
Procedure .....	142
Peak Search .....	144
Maximal Point and Minimal Point .....	144
Positive Peak and Negative Peak .....	145
Outline of Peak Search Function .....	146
Procedure .....	146
Define the Peaks Using Marker .....	148
Working Out Trace Average, Standard Deviation, and Peak to Peak .....	151
Procedure .....	151
Specify the Partial Search Area .....	153
Procedure .....	153
Execution of Automatic Search in Each Sweep (Search Tracking) .....	155
Procedure .....	155
Changing Marker Stimulus Value Display to Time/Relaxation Time .....	156
Procedure .....	156
Calculation of Equivalent Circuit Parameter and Simulation of Frequency Characteristics .....	157
Calculation of Equivalent Circuit Parameter based on Measurement Results .....	157
Frequency Characteristics Simulation based on Equivalent Circuit Parameters .....	158
Setting a Limit to the Trace and Making a Pass/Fail Determination .....	160
Procedure .....	161

<b>7. Saving and Recalling Internal Data</b>	
Overview of Save and Recall Functions . . . . .	166
Saving and Recalling Setting States (Save State) . . . . .	169
To save setting states: . . . . .	169
To recall setting states: . . . . .	170
Saving and Recalling Measurement Data in Binary Format . . . . .	172
To save measurement data in binary format: . . . . .	172
To recall measurement data: . . . . .	173
Saving Measurement Data to Read in Spreadsheet Software (Saving in ASCII Format) . . . . .	175
To save measurement data in ASCII format: . . . . .	176
To import measurement data saved in ASCII format into Microsoft Excel™: . . . . .	177
Saving Measurement Data in CITIfile Format . . . . .	179
Overview of CITIfile Data Format . . . . .	179
How to Create a CITIfile on the E4991A . . . . .	179
CITIfile Structure . . . . .	180
To create a CITIfile: . . . . .	181
Saving Display Information (Save Graphics) . . . . .	183
To save display information: . . . . .	183
Recalling Saved Image File . . . . .	184
<b>8. Printing Measurement Results and Internal Data</b>	
Printing Measurement Graphs and Internal Data Lists . . . . .	186
Supported Printers . . . . .	187
How to print data on the screen . . . . .	187
Installing Printer Drivers . . . . .	191
How to install a printer driver: . . . . .	191
<b>9. Setup and Use of Control/Management Functions</b>	
Setting the GPIB . . . . .	194
Setting talker/listener GPIB address of E4991A . . . . .	194
Setting system controller (USB/GPIB interface) . . . . .	194
Setting the Internal Clock . . . . .	197
Procedure for setting the internal clock . . . . .	197
Setting the Mouse . . . . .	200
Setup Step . . . . .	200
Confirmation of Options and Firmware Version . . . . .	203
Operation Procedure . . . . .	203
System Recovery . . . . .	204
Types of system recoveries . . . . .	204
Notes on executing system recovery . . . . .	204
Procedure to execute system recovery . . . . .	205
Procedure to create the user backup image . . . . .	208
Procedure to execute the user recovery function . . . . .	211
<b>10. Using LAN</b>	
Configuring the Network . . . . .	216
Enabling/disabling network . . . . .	216
Setting IP address . . . . .	218

Specifying computer name . . . . .	220
File Transfer Using FTP . . . . .	223
FTP file transfer using MS-DOS™ prompt . . . . .	223
FTP file transfer using FTP application software . . . . .	226
Stop/Abortion of process/Cut off from server by E4991A operation . . . . .	227
Using Remote User Interface . . . . .	228
Outline of Remote User Interface . . . . .	228
Installation of E4991A user interface software . . . . .	230
Procedure to uninstall E4991A user interface . . . . .	232
Starting up the E4991A user interface and connecting to the E4991A measurement server . . . . .	233
Disconnection of E4991A measurement server . . . . .	235
Closing the E4991A user interface . . . . .	236
Copying measurement plot and internal data to other application software . . . . .	236

## 11. Specifications and Supplemental Information

Definitions . . . . .	238
Measurement Parameters and Range . . . . .	238
Measurement Parameters . . . . .	238
Measurement Range . . . . .	238
Source Characteristics . . . . .	239
Frequency . . . . .	239
Oscillator Level . . . . .	239
Output Impedance . . . . .	240
DC Bias (Option 001) . . . . .	241
DC Voltage Bias . . . . .	241
DC Current Bias . . . . .	241
DC Bias Monitor . . . . .	241
Probe Station Connection Kit (Option 010) . . . . .	242
Oscillator Level . . . . .	242
Sweep Characteristics . . . . .	243
Sweep Conditions . . . . .	243
Segment Sweep . . . . .	243
Measurement Accuracy . . . . .	244
Conditions for Defining Accuracy . . . . .	244
Accuracy When Open/Short/Load Calibration is Performed . . . . .	244
Accuracy When Open/Short/Load/Low-Loss Capacitor Calibration is Performed (point averaging factor $\geq$ 8, typical) . . . . .	245
Definition of Each Parameter . . . . .	245
Calculated Impedance Measurement Accuracy . . . . .	247
Measurement Support Functions . . . . .	252
Error Correction . . . . .	252
Trigger . . . . .	253
Averaging . . . . .	253
Display . . . . .	253
Marker . . . . .	254
Equivalent Circuit Analysis . . . . .	254
Limit Marker Test . . . . .	254
Mass Storage . . . . .	254
Interface . . . . .	255

Measurement Terminal (at Test Head) . . . . .	255
Rear Panel Connectors . . . . .	255
General Characteristics . . . . .	257
Environment Conditions . . . . .	257
Other Specifications . . . . .	258
Option 002 Material Measurement (typical) . . . . .	263
Measurement Parameter . . . . .	263
Frequency Range . . . . .	263
Measurement Accuracy . . . . .	263
Examples of Calculated Permittivity Measurement Accuracy . . . . .	266
Examples of Calculated Permeability Measurement Accuracy . . . . .	271
Option 007 Temperature Characteristic Test Kit . . . . .	276
Operation Temperature . . . . .	276
Source Characteristics . . . . .	276
Measurement Accuracy (at 23°C ± 5°C) . . . . .	276
Typical Effects of Temperature Change on Measurement Accuracy . . . . .	282
Typical Material Measurement Accuracy When Using Option 002 and 007 . . . . .	285
Measurement Parameter . . . . .	285
Typical Effects of Temperature Change on Permittivity Measurement Accuracy . . . . .	298
<b>A. Manual Changes</b>	
Manual Changes . . . . .	308
Change 6 . . . . .	309
Change 5 . . . . .	309
Change 4 . . . . .	312
Change 3 . . . . .	314
Change 2 . . . . .	316
Change 1 . . . . .	318
<b>B. Probe Station Connection Kit (Option 010)</b>	
Option 010 Overview . . . . .	322
Recommended Probe Stations . . . . .	323
Recommended Probe Heads . . . . .	323
Mounting Test Head and Connecting Cables (using recommended probe station) . . . . .	324
Mounting Test Head and Connecting Cables (using probe stations other than recommended models) . . . . .	327
OPEN/SHORT/LOAD Calibration . . . . .	328
Selecting Fixture Type . . . . .	328
Definition of Calibration Kit . . . . .	328
Calibration/Compensation Measurement Point Mode . . . . .	329
Calibration of Open/Short/Load . . . . .	330
<b>C. Temperature Characteristic Test Kit (Option 007)</b>	
Overview . . . . .	334
Installation . . . . .	335
Cautions for protecting cable . . . . .	335
Connection procedure . . . . .	336

---

# Contents

Calibration/compensation . . . . .	340
Temperature compensation . . . . .	341
Execution procedure of temperature compensation . . . . .	341
Information to create program to execute temperature compensation . . . . .	341
Acquiring temperature compensation data . . . . .	344
Measuring temperature characteristic using sample program . . . . .	351
Measuring temperature characteristic using Tctest.Start macro . . . . .	352
Temperature compensation for measurement result using Compensation.Start macro . . . . .	369
Modifying attached sample program . . . . .	371
Changing limits when setting temperature change pattern . . . . .	371
Changing GPIB address . . . . .	372
Modifying other temperature chambers than recommended . . . . .	372
Recovery of the sample program furnished the option 007 . . . . .	375
<b>D. Menu References</b>	
Menu References . . . . .	378
Trace Menu . . . . .	378
Meas/Format Menu . . . . .	379
Scale Menu . . . . .	380
Display Menu . . . . .	384
Marker Menu . . . . .	389
Stimulus Menu . . . . .	397
Trigger Menu . . . . .	409
Utility Menu . . . . .	411
Save/Recall Menu . . . . .	416
System Menu . . . . .	418
<b>E. Theory on Material Measurement</b>	
Dielectric Material Measurement . . . . .	424
Definition of Permittivity . . . . .	424
Measurement Principle of Dielectric Material . . . . .	425
Error Components of 16453A Test Fixture . . . . .	426
Magnetic Material Measurement . . . . .	428
Definition of Permeability . . . . .	428
Measurement Principle of Magnetic Material . . . . .	429
Structure of 16454A Test Fixture . . . . .	432
<b>F. Information on Maintenance</b>	
Cleaning this Instrument . . . . .	434
Cleaning an LCD . . . . .	434
Maintenance of Connectors/Ports . . . . .	434
Cleaning a Display Other than an LCD . . . . .	436
Cautions Applicable to Requesting Repair, Replacement, Regular Calibration, etc. . . . .	437
Devices to be Sent Back for Repair or Regular Calibration . . . . .	437
Recommended Calibration Period . . . . .	437
<b>G. Initial Settings</b>	
Initial Settings, Settings that can be Saved/Recalled, Settings that can be Backed Up . . . . .	440

<b>H. Comparison Information of 4291B and E4991A</b>	
Major Differences . . . . .	452
Channels and Traces . . . . .	452
Calibration/Compensation . . . . .	452
Marker . . . . .	453
Limit test . . . . .	453
Function Comparison List . . . . .	454
<b>I. Messages</b>	
Alphabetical Order . . . . .	462
A . . . . .	462
B . . . . .	462
C . . . . .	462
D . . . . .	464
E . . . . .	464
F . . . . .	465
G . . . . .	465
I . . . . .	465
M . . . . .	467
N . . . . .	467
O . . . . .	469
P . . . . .	469
Q . . . . .	470
R . . . . .	471
S . . . . .	471
T . . . . .	472
U . . . . .	473
Messages indicating the internal status of the equipment . . . . .	474
Messages indicating measurement failure . . . . .	474
Messages indicating the results (or current status) of processing . . . . .	475





---

# 1      **How to Use This Operation Manual**

This chapter explains how to most efficiently use this Operation Manual.

## Relationship of Operation Manual Contents to Using the E4991A

The chapters of this Operation Manual cover the usage of this product from when it is delivered until when the user has obtained sufficient understanding of the instrument's functions to use it efficiently. Table 1-1 lists the product's operations along with the corresponding manuals and chapters.

**Table 1-1 Operations of E4991A and Corresponding Manuals/Chapters**

Operation	Corresponding Manual	Corresponding Chapter
1. Installation	<i>Installation and Quick Start Guide</i>	Chapter 2, "Installation Guide"
2. Understanding functions and measurement flow	<i>Installation and Quick Start Guide</i>	Chapter 3, "Basic Operations for RF Devices Measurement" Chapter 4, "Basic Operations for Dielectric Measurement" Chapter 5, "Basic Operations for Magnetic Measurement"
	<i>Operation Manual</i> (this book)	Chapter 2, "Function Overview," on page 21
3. Performing measurements (manual operation)	<i>Operation Manual</i> (this book)	Chapter 3, "Setting Measurement Conditions," on page 41 Chapter 4, "Calibration and Compensation," on page 75 Chapter 5, "Display Setting," on page 95 Appendix B, "Probe Station Connection Kit (Option 010)," on page 321 Appendix C, "Temperature Characteristic Test Kit (Option 007)," on page 333
4. Analyzing and handling measurement data (manual operation)	<i>Operation Manual</i> (this book)	Chapter 6, "Analysis of Measurement Results," on page 127 Chapter 7, "Saving and Recalling Internal Data," on page 165 Chapter 8, "Printing Measurement Results and Internal Data," on page 185
5. Using control and management facilities (manual operation)	<i>Operation Manual</i> (this book)	Chapter 9, "Setup and Use of Control/Management Functions," on page 193 Chapter 10, "Using LAN," on page 215
6. Development of automatic measurement system	<i>Programming Manual</i>	All chapters

---

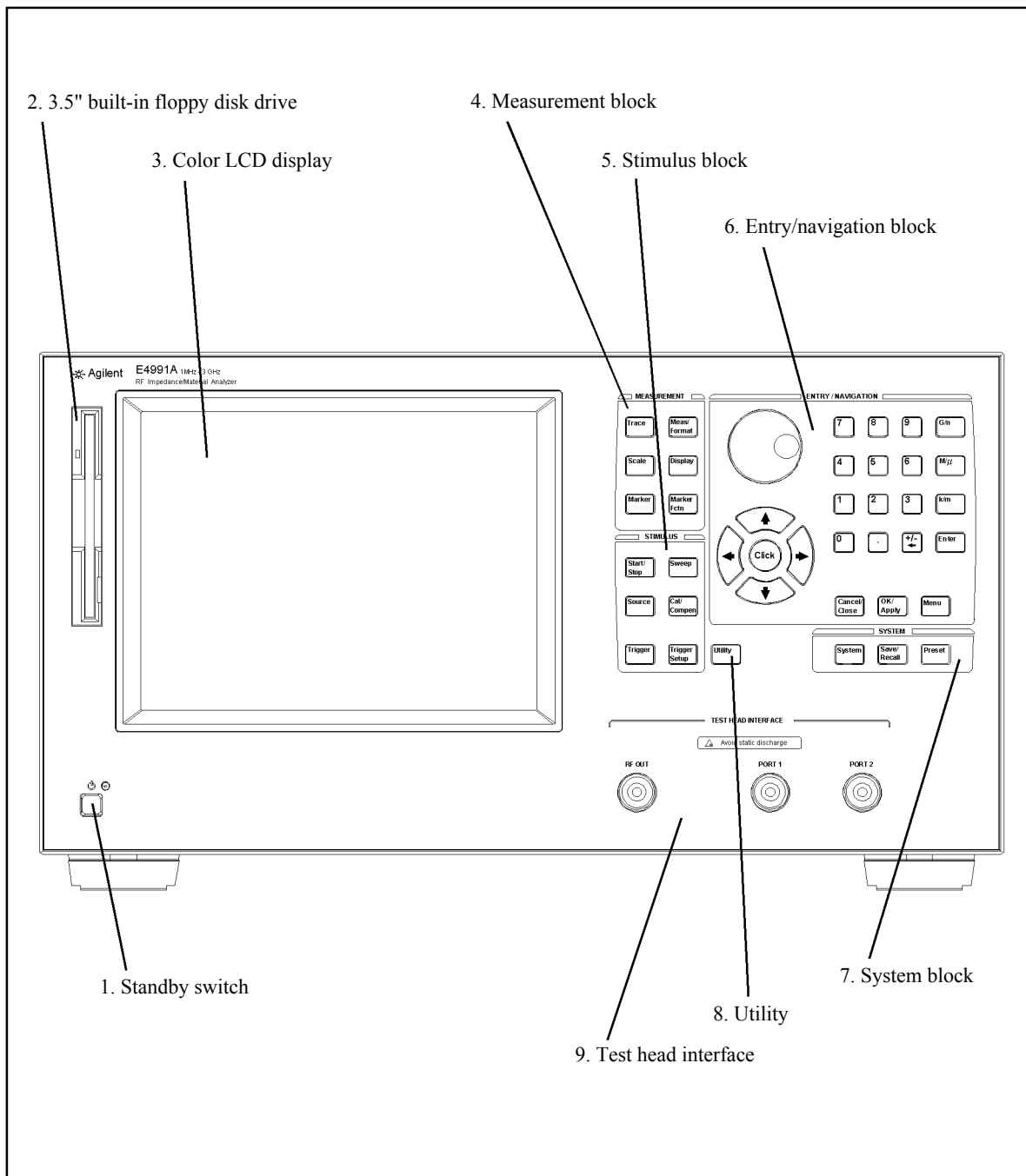
## 2 Function Overview

This chapter describes the functions of the Agilent E4991A Impedance/Material Analyzer available to the user from the front panel, rear panel, and LCD display blocks.

## Names and Functions of Front Panel Blocks

The names and functions of the E4991A front panel blocks are shown below.

Figure 2-1 E4991A front panel



e4991aaj001

## 1. Standby switch

Used to turn on/off the power to the E4991A.

---

### NOTE

To turn off the power to the E4991A, be sure to press this power supply switch. Alternatively, activate the E4991A shutdown process (i.e., software and hardware process required to turn off the power) by sending a shutdown command from the external controller. **You must never directly shut off the power supply by removing the power cable from the receptacle on the rear panel.**

If the power supply is directly shut off by removing the power cable, the shutdown process is not activated, and this may damage the E4991A software and hardware, resulting in operational failures.

**If the E4991A shutdown process is not properly executed, the E4991A may restart in safe mode. If this happens, activate the shutdown process to turn off the power to the E4991A and then press the standby switch to turn the power on again.**

For turning on/off the power, also refer to Chapter 1, “Installation Guide” in the *Installation and Quick Start Guide*.

---

## 2. 3.5-inch built-in floppy disk drive

This device is used to save the E4991A settings, measured data, calibration/compensation data, image data displayed on the LCD display, VBA (Visual Basic for Applications) programs, and other data to a floppy disk or to recall them. It works with 3.5-inch 1.44 MB DOS formatted floppy disks.

The floppy disk access lamp is located to the left of the disk slot. It lights up in green when the floppy disk drive accesses the disk by either read or write operation.

The disk eject button is located to the right of the disk slot. By pressing it, the currently inserted disk can be ejected.

---

### NOTE

Insert the floppy disk into the slot in the direction of the arrow denoted on the disk, **with the labeled side facing the LCD display.**

**Do not press the disk eject button while the floppy disk access lamp is lit.** If you attempt to forcibly eject the disk, the disk or drive may be destroyed.

---

## 3. Color LCD display

This displays all of the information required to operate the E4991A (e.g., measurement trace, settings, menu and setup bars). It is an 8.4-inch TFT type display.

For details on the information displayed on the LCD display, see “Names and Functions of LCD Display Areas” on page 32.

## 4. Measurement block (MEASUREMENT)



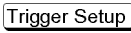
This contains a set of keys that are used to set the basic measurement conditions, except for the test signal settings. Pressing one of these keys brings up the associated toolbar to the right of the display.

<b>Trace</b> key	Used to select the desired trace to set (i.e., active trace). Each time you press this key, one of the active traces on the display is selected in order. When setting the measurement conditions, you must first use this key to select the active trace.
<b>Meas/Format</b> key	Used to show the Meas/Format toolbar at the right of the display. By working with this toolbar, you can select measurement parameters, set the vertical-axis form (linear or log) of a measurement graph, and perform other related tasks.
<b>Scale</b> key	Used to show the Scale toolbar at the right of the display. By working with this toolbar, you can set the scale of a measurement graph (e.g. total width, position of reference line).
<b>Display</b> key	Used to show the Display toolbar at the right of the display. By working with this toolbar, you can set the general settings of the view on the display, except for the vertical-axis form of a measurement graph and scale settings.
<b>Marker</b> key	Used to show the Marker toolbar at the right of the display. By working with this toolbar, you can set the basic settings of the marker, which is a small inverted delta symbol( $\nabla$ ). By using the marker, various measurement trace parameters can be read at specified values.
<b>Marker Fctn</b> key	Used to show the Marker Fctn (function) toolbar at the right of the display. By working with this toolbar, you can set the E4991A to run an analysis (search) with the marker.

## 5. Stimulus block (STIMULUS)




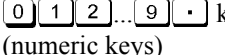




This contains a set of keys that are used to set the signal source. Pressing one of these keys causes the associated toolbar to be recalled at the right of the display.



<b>Start/Stop</b> key	Used to show the Start/Stop toolbar at the right of the display. By working with this toolbar, you can define the sweep span by setting a pair consisting of either a sweep start and sweep stop value or of a sweep center and sweep span value.
<b>Sweep</b> key	Used to show the Sweep Setup toolbar at the right of the display. By working with this toolbar, you can set the sweep conditions such as selection of sweep parameters and linear/log sweep.
<b>Source</b> key	Used to show the Source toolbar at the right of the display. By working with this toolbar, you can set the oscillator level, CW frequency, DC bias level, and other values.

 key	Used to show the Cal/Compen toolbar at the right of the display. By working with this toolbar, you can set up and execute calibration and compensation.
 key	Manual trigger key. If you press this in the manual trigger mode, the trigger is activated, initiating a measurement.
 key	Used to show the Trigger Setup toolbar at the right of the display. By working with this toolbar, you can set trigger settings such as the parameters for the trigger source (internal, external, manual, or GPIB).

## 6. Entry/navigation block (ENTRY/NAVIGATION)

This contains a set of keys that are used to move the cursor across the display or enter numeric values.

 (rotary knob)	By turning the knob clockwise or counterclockwise, you can move the onscreen setting cursor. If you press this knob with the cursor placed over a feature, it is selected and executed.
 key (arrow keys)	Used to move the onscreen setting cursor up, down, left, or right.
 key (click key)	By pressing this key, you can select and execute the feature that the cursor is placed over. It has the same function as pressing the rotary knob.
 key (numeric keys)	Used to type numeric values, one by one, in the cursor position. By pressing a unit key after entering a value, the value and unit are set and executed.
 key	When you press this key in an area where numeric values are typed, the character to the left of the cursor ( ) is deleted. If two or more characters are currently selected (i.e., highlighted) with the cursor, pressing this key clears all of them. If the numeric entry area contains no characters, input and deletion of '-' repeats each time you press this key.
 key (unit keys)	By pressing one of these keys after entering a numeric value with the numeric keys, the entry is set and executed with the prefix indicating unit of measurement added to the value. Two unit prefixes are labeled on each key except  ; however, the appropriate unit is determined automatically depending on the parameter being set. If you press the  key, the entered value is executed without a unit prefix.

- Cancel/Close** key Used to close the setup toolbar at the right of the display. Also, by pressing this key when a dialog box is onscreen, you can cancel any entry mode and the box closes (i.e., this key can be used instead of pressing the **Cancel** or **x** button in a dialog box).
- OK/Apply** key When you press this key when a dialog box is onscreen, the entered setting is executed and the box closes. This key can also be used instead of pressing the **OK** button in a dialog box.
- Menu** key By pressing this key, the leftmost menu opens in the menu bar at the top of the display. Then, the arrow keys () can be used to move the cursor to other menus or to the desired item in a menu. Pressing the click key () selects and executes the item. The **Menu** key is used to work with the menu bar when a mouse is not available.
- To close an open menu, press the **Menu** key again.

## 7. System block (SYSTEM)

This contains a set of keys that are used to set the control and management of the entire E4991A unit and to save/recall and preset (initialize) files.

- System** key Used to show the System Setup toolbar. By working with this toolbar, you can make control and management settings for the entire E4991A unit.
- Save/Recall** key Used to show the Save/Recall toolbar. By working with this toolbar, you can save the E4991A settings, measured data, calibration/compensation data, image data displayed on the LCD display, and VBA programs in the E4991A storage devices (e.g., floppy disk, nonvolatile memory) or recall them from storage.
- Preset** key Initializes the E4991A to the “Preset State” status.

## 8. Utility key (**Utility** key)

Used to show the Utility toolbar. By working with this toolbar, you can edit and execute VBA programs or set the E4991A to run an equivalent circuit analysis.

## 9. Test head interface (TEST HEAD INTERFACE)

This is the interface used to connect the test head. It contains three ports: RF OUT and PORTs 1 and 2, each of which is an N-type female connector.

---

### NOTE

You must not apply either alternate or direct current to the test head interface. Doing this could cause operational failure.

---

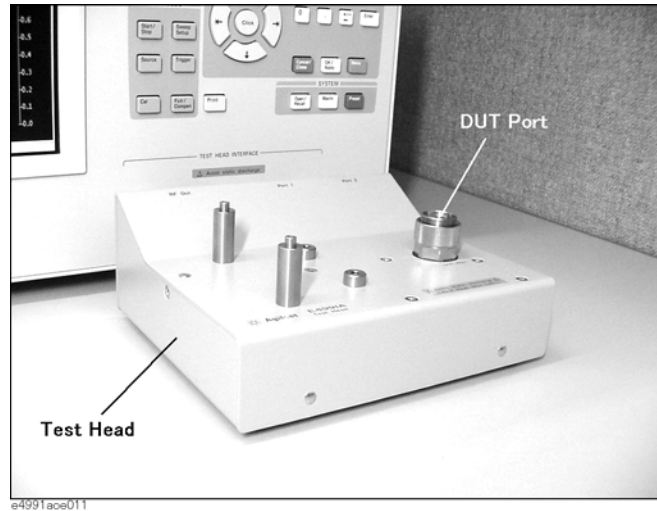


### Test head

The test head's DUT port (Figure 2-2) is classified as IEC61010-1 Installation Category I.

Figure 2-2

Test head connected to the E4991A and its DUT port



---

**CAUTION**



You must not apply either alternate or direct current to the DUT port. Doing this could cause operational failure. Pay particular attention to whether the capacitor has been charged. Fully discharge the device under test before connecting it to the test head DUT port (or test fixture).

---

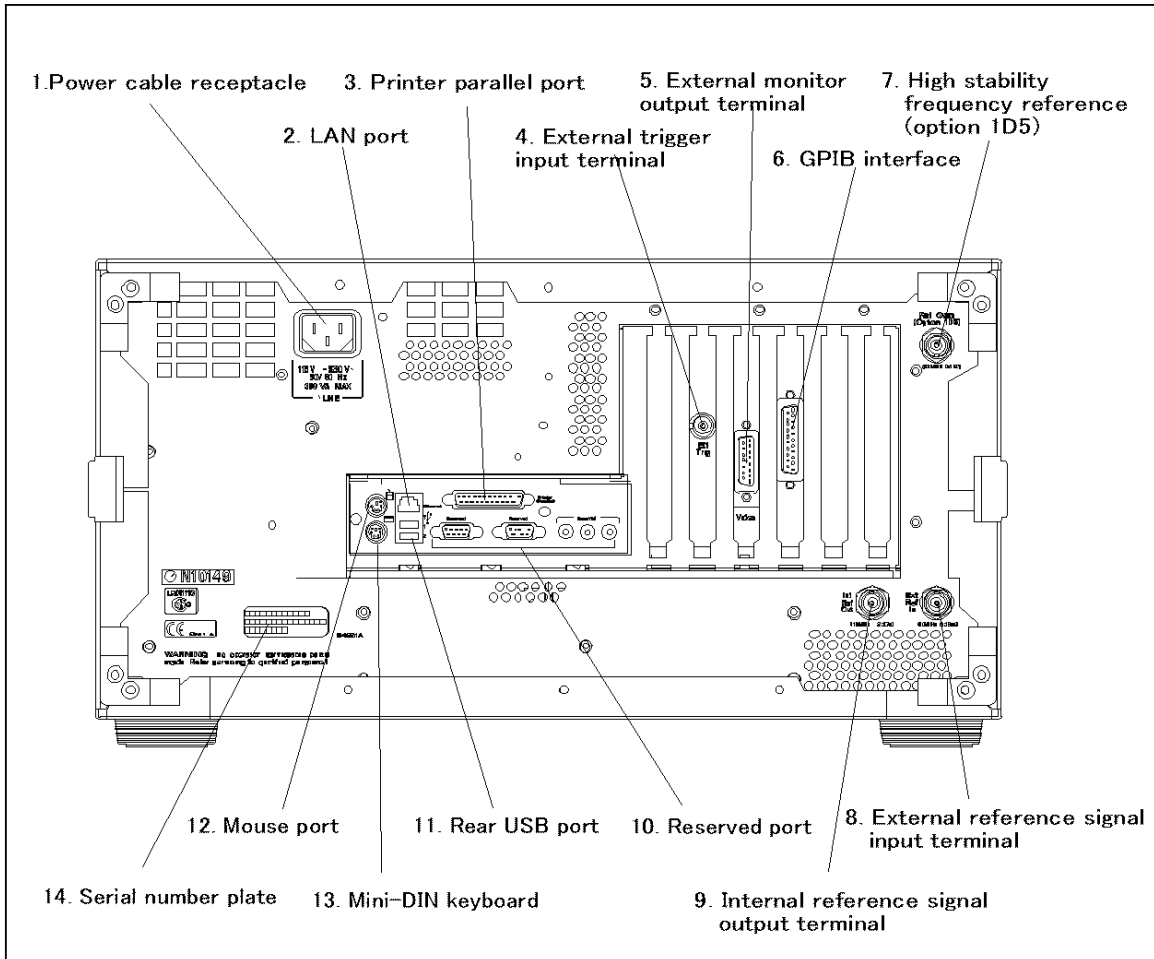
**CAUTION**

*Whenever you connect a DUT to or disconnect it from the DUT port for measurement, you must first turn off the dc bias or set the sweep to the hold state (in sweep hold state, dc bias is not applied to the DUT). If this step is not taken, the dc bias may destroy the DUT.*

## Names and Functions of Rear Panel Blocks

The names and functions of the E4991A rear panel blocks are shown below.

Figure 2-3 E4991A Rear Panel



E4991aee6001

## 1. Power cable receptacle (-LINE)

This is the receptacle for connection of the power cable.

For the requirements of the power supply, refer to Chapter 1, “Installation Guide” in the *Installation and Quick Start Guide*.

---

### NOTE

---

For the power cable, use the attached 3-wire power cable with grounding prong. For details, refer to Chapter 1, “Installation Guide” in the *Installation and Quick Start Guide*.

## 2. LAN port

Connector type: RJ-45J UTP (Unshielded Twisted Pair) LAN connector

Using this port, the E4991A can be connected to a Local Area Network (LAN). For how to use the instrument in a LAN, refer to the *Programming Manual*.

## 3. Printer parallel port (PRINTER, Parallel)

This is a 25-pin parallel port used for connecting a printer. With the specified printer connected to this port, you can print E4991A measurement graphs, measurement values list, settings list, and other data. For the printers that can be used with the E4991A, see “Supported Printers” on page 187.

## 4. External trigger input connector (Ext Trig)

Connector type: BNC connector (female)

This is the terminal through which a trigger signal is input to begin execution of measurement. It detects a trigger by the rising or falling edge following the Low or High level of a TTL-compatible signal. To trigger measurement with a signal input to this terminal, you must set the trigger source to EXTERNAL (external trigger input connector). For details of the input signal requirements of this terminal, see “External trigger input connector” on page 256.

## 5. External monitor output terminal (VIDEO)

Connector type: 15-pin VGA connector

This is the terminal used for connecting an external color monitor (display device). With a color monitor connected to this terminal, the same information that is displayed on the E4991A LCD display can be viewed on the monitor screen.

## 6. GPIB connector

This is a General Purpose Interface Bus (GPIB) connector. An auto-measurement system can be constructed by connecting an external controller or other equipment via this connector. For more details on auto-measurement systems that utilize a GPIB, refer to the *Programming Manual*.

## 7. High stability frequency reference output connector (Ref Oven, Option 1D5 only)

Connector type: BNC connector (male)

If Option 1D5 High Stability Frequency Reference is installed in the E4991A, this terminal outputs the reference signal.

---

**NOTE**

When Option 1D5 is installed, connect this terminal and “8. External reference signal input terminal (Ext Ref In, 10 MHz 0 dBm)” to the option by using the included BNC(m)-BNC(m) cable.

---

### **8. External reference signal input terminal (Ext Ref In, 10 MHz 0 dBm)**

Connector type: BNC connector (male)

This is a signal input terminal used to phase-lock the E4991A test signal to an external frequency reference signal. The accuracy of test signal frequency can be improved by inputting the external frequency reference signal to this terminal.

When the external frequency reference signal is input to this input terminal, the E4991A test signal is automatically phase-locked to its reference signal. When the signal input is no longer generated, the frequency reference signal in the E4991A is automatically used instead.

---

**NOTE**

If option 1D5 has been installed, connect this terminal and “7. High stability frequency reference output connector (Ref Oven, Option 1D5 only)” to the option by using the included BNC(m)-BNC(m) cable.

---

### **9. Internal reference signal output connector (Int Ref Out)**

Connector type: BNC connector (male)

This is an output terminal for the E4991A internal reference signal. By connecting this terminal and the external reference signal input terminal of other equipment, it can be used by phase-locking it with the E4991A reference signal.

### **10. Unused ports (Reserved)**

These ports are not available. Do not connect any device here.

### **11. Rear USB port**

This is a USB (Universal Serial Bus) port (number of ports: 2) used to connect a mouse, a USB/GPIB interface, or a printer. Using a mouse, you can efficiently make various settings by freely moving the cursor across the E4991A LCD display. With the specified printer connected to this port, you can print E4991A measurement graphs, measurement value lists, settings lists, and other data. For the printers that can be used with the E4991A, see [Printing Measurement Graphs and Internal Data Lists](#) on page xxx.

---

**NOTE**

Be sure to only use a mouse, a USB/GPIB interface, or a printer designated for use with the E4991A. Using a mouse other than those designated may cause incorrect actions to occur.

---

### **12. Mini-DIN mouse port (MOUSE)**

This is a port used to connect a mouse equipped with a Mini-Din connector. Using a

mouse, you can efficiently make various settings by freely moving the cursor across the E4991A LCD display.

---

**NOTE**

Use of a mouse other than the one specified for use with the E4991A may lead to operation error. Be sure to only use the mouse provided by Agilent Technologies.

The mouse has two buttons: left and right, which operate in a different manner. As used in this manual, the term “clicking with the mouse” indicates pressing the left mouse button.

---

### **13. Mini-Din keyboard port (KYBD)**

This port is used to connect a Mini-DIN style keyboard. Because alphabetic characters and symbols directed to the E4991A can be input only through a keyboard, you will need it for such tasks as editing a VBA program or typing a file name.

The arrow and numeric keys on the keyboard operate in the same manner as those on the E4991A front panel. Thus, you can use the keyboard for cursor navigation instead of operating the front panel or mouse.

---

**NOTE**

Use of a keyboard other than the one specified for use with the E4991A may lead to operation error. Be sure to only use the keyboard provided by Agilent Technologies.

---

### **14. Serial number plate**

This is a plate showing the serial number, i.e., the production number of the product.

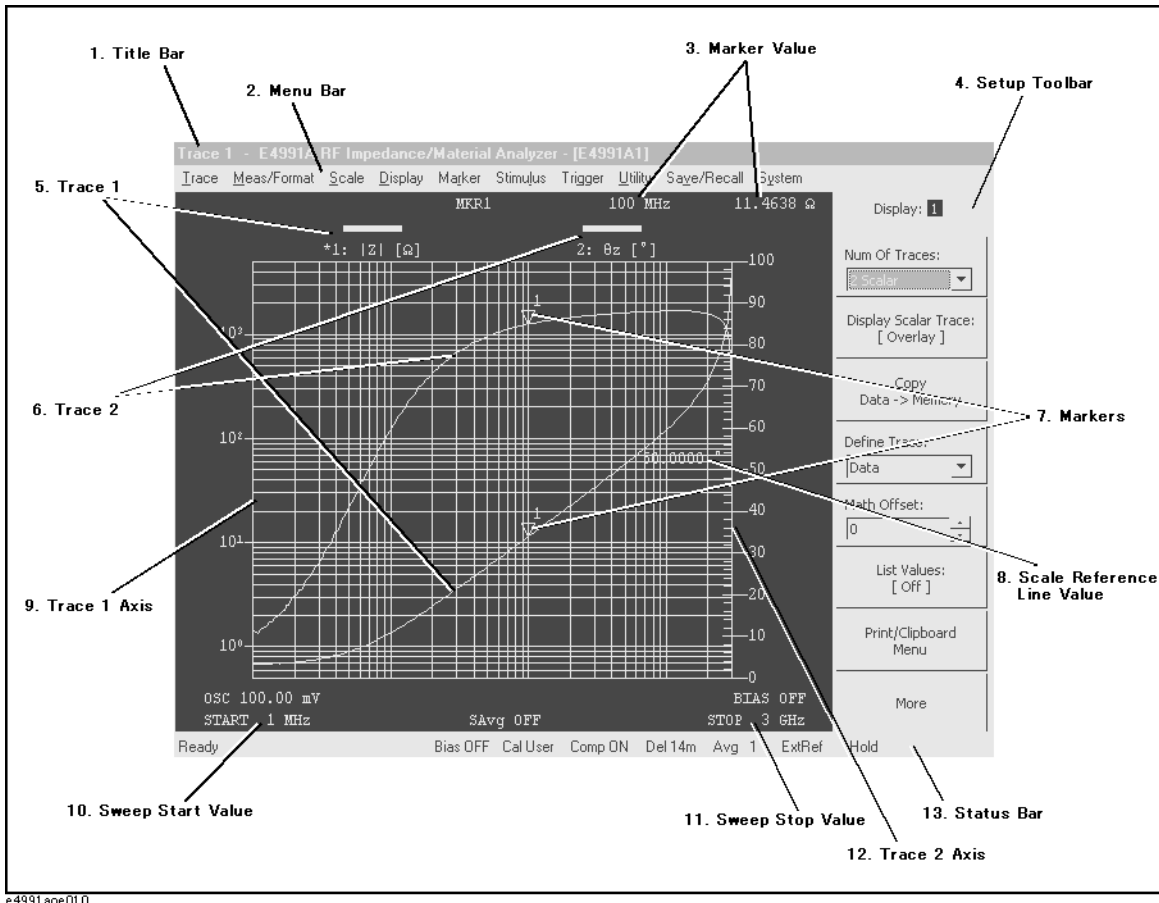
### **15. Unused ports (Reserved)**

These two ports are not available.

## Names and Functions of LCD Display Areas

The names and functions of the areas of the LCD display are shown below.

Figure 2-4 LCD display








### 1. Title bar


This displays the title that the user defines and enters. This is useful when printing and saving the onscreen measurement results.



### 2. Menu bar






You can make most settings for the E4991A by working with this menu bar in any or all of the following ways:

- o Using the **mouse** connected to the E4991A, click a menu name on the menu bar. In the menu that appears, select the desired menu item by clicking with the mouse.
- o Press the **Menu** key in the "6. Entry/navigation block (ENTRY/NAVIGATION)" on page 25 on the **front panel**. The leftmost menu of the menu bar opens. Using the

appropriate arrow keys (   ) , move the cursor to the desired menu and menu item. Then press the click key () to select and execute the item.












To dismiss the currently open menu, press the  key again.

- o While holding down the  key on the **keyboard** connected to the E4991A, type the alphabetic character underlined in the desired menu name to open the menu. In the menu that appears, select the desired menu item by typing the underlined character in the same manner. You do not need to press the  key after making a selection in this way.

Once a menu opens, you can use the following operations instead of the above. First, use the appropriate arrow keys (   ) on the keyboard to move the cursor up, down, left, or right over the menus. Then press the  key on the keyboard to select and execute the desired item.

Function Overview  
**Names and Functions of LCD Display Areas**

**Summary of working with the menu bar**

Operation	Front panel			External device	
	 (Rotary knob)	 (Arrow keys)	Other keys	Keyboard	Mouse
Open the menu on the menu bar	(Disabled)	(Disabled)	Press <b>Menu</b> (to open the menu at the far left)	Press <b>Alt</b> and an alphabetic character key* <sup>1</sup> together	Click the desired menu name on the menu bar (to open the menu)
Dismiss the menu bar without execution	(Disabled)	(Disabled)	Press <b>Menu</b>	Press <b>Alt</b>	Click the menu name on the currently open menu bar
Move to the next menu on the left	(Disabled)	Press 	(Disabled)	Press 	Move the pointer to the desired menu name on the menu bar
Move to the next menu on the right	(Disabled)	Press 	(Disabled)	Press 	Move the pointer to the desired menu name on the menu bar
Move the cursor up in a menu	(Disabled)	Press 	(Disabled)	Press  or an alphabetic character key* <sup>1*2</sup>	Move the pointer to the desired menu name on the menu bar
Move the cursor down in a menu	(Disabled)	Press 	(Disabled)	Press  or an alphabetic character key* <sup>1*2</sup>	Move the pointer to the desired menu name on the menu bar
Select an execute the menu item in the cursor position	(Disabled)	Press 	(Disabled)	Press <b>Enter</b>	Click the menu item name

\*1. The alphabetic character underlined in the menu or menu item name.

\*2. When you press an alphabetic character key, the menu or menu item is selected or executed without pressing **Enter**.

### 3. Marker values

This displays values at the marker position (∇) on the onscreen active trace.

Marker sweep parameter value (in this example, 100 MHz)	Displays the value of the sweep parameter in the marker position (in this example, frequency). In this example, displays the numeric value that represents the position on the horizontal axis.
---	---



Marker measurement parameter value (in this example, 11.4638 Ω)	Displays the value of the measurement parameter in the marker position (in this example,  Z  value). In this example, displays the numeric value that represents the position on the vertical axis.
---	---

#### 4. Setup toolbar

This is a vertical toolbar used to make various settings for the E4991A.

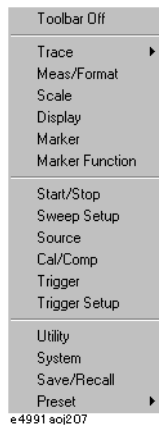
##### Recalling the desired setup toolbar

You can recall the desired toolbar in any of the following ways:

- o Press one of the following hardkeys to show the setup toolbar associated with that key:
  - Keys in “4. Measurement block (MEASUREMENT)” on page 23 (except for **Trace**)
  - Keys in “5. Stimulus block (STIMULUS)” on page 24 (except for **Trigger**)
  - Keys in “7. System block (SYSTEM)” on page 26 (except for **Preset**)
  - **Utility**
- o Work with the “2. Menu bar” on page 32 to show the setup toolbar associated with a menu item.
- o Right-click to open the shortcut menu (Figure 2-5) and click the desired setup toolbar name.

Figure 2-5

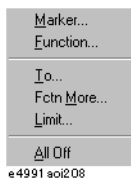
##### Shortcut menu



You can also bring up the marker shortcut menu (Figure 2-6) by right-clicking a marker (V) on the display.




Figure 2-6






##### Marker shortcut menu














**Working with the setup toolbar**

You can work with a displayed toolbar in any of the following ways:




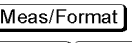



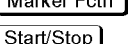
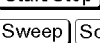


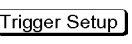
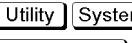



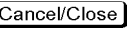

- o Using the **mouse** connected to the E4991A, directly click the setting item on the setup toolbar.
- o Move the cursor to the desired block in the toolbar by using the Up and Down arrow keys ( ) in the entry/navigation block on the front panel. Then press the click key () for selection and execution.











































Instead of pressing the  and  keys, you can turn the rotary knob () counterclockwise or clockwise to achieve the same result. Instead of the click key (), you can press the rotary knob () for selection and execution.

To move the cursor over the blocks in a toolbar, use the   keys.

- o Move the cursor down to the desired block in a toolbar by pressing  (or move the cursor up by holding down  and pressing ) on the keyboard connected to the E4991A. Then press the  key for selection and execution. To open a drop-down list box, hold down  while pressing , and then choose an item from the drop-down list box by releasing  and using  and .

**Summary of working with the setup toolbar**

Operation	Front panel			External device	
	 (Rotary knob)	 (Arrow keys)	Other keys	Keyboard	Mouse
Display the desired setup toolbar	(Disabled)	Work with the menu bar <sup>*1</sup> in combination with the  key (disabled alone)	Press one of the following:             	Work with the menu bar <sup>*1</sup>	Work with the menu bar <sup>*1</sup>
Dismiss the setup toolbar	(Disabled)	(Disabled)	Press 	Press 	Right-click to open the shortcut menu and press <b>Toolbar Off</b>

Operation	Front panel			External device	
	 (Rotary knob)	 (Arrow keys)	Other keys	Keyboard	Mouse
In the toolbar, move the cursor down the blocks	Turn counterclockwise	Press 	(Disabled)	Press 	Directly click the desired setting area in the toolbar
In the toolbar, move the cursor up the blocks	Turn clockwise	Press 	(Disabled)	Press and hold down  and then press 	Directly click the desired setting area in the toolbar
Open a drop-down list box	Press	Press 	(Disabled)	Press and hold down  and then press 	Directly click the drop-down list box
Move the cursor in a drop-down list box	Turn counterclockwise or clockwise	Press  or 	(Disabled)	Press  or 	Directly click the desired menu item (to select/execute)
Enter numeric values	(Disabled)	(Disabled)	Press    ...   	Press    ..   	Right-click the entry box to open the numeric entry dialog box and click the desired buttons
Execute numeric data entry with the unit added	(Disabled)	(Disabled)	Press  ,  ,  or  (executed)	Type the unit and press  (executed)	Right-click the entry box to open the numeric entry dialog box and click the desired buttons
Increase/Decrease the entered numeric values	Press and turn clockwise or counterclockwise	Press  and then press  or 	(Disabled)	Press  or 	Click <b>s</b> or <b>t</b> to the right of the entry box
Enter characters	(Disabled)	Work with the <b>Keyboard</b> dialog box displayed by the <b>Keyboard...</b> button	(Disabled)	Press   	Work with the <b>Keyboard</b> dialog box displayed by the <b>Keyboard...</b> button
Enter and select	Press	Press 	Press 	Press 	Select/execute by clicking the setting area

\*1. For working with the menu bar, see “2. Menu bar” on page 32.

## 5. Trace 1

This is one of the traces that can be displayed simultaneously on the E4991A. The bar indicating the trace and scale colors of Trace 1 as well as the measurement parameter names and their units (in this example,  $|Z|$  [ $\Omega$ ]) are displayed in the upper-left corner of the graph. The asterisk (“\*”) to the left of the trace number (1 for this trace) indicates that the trace is the active trace (target trace for setups). One of the traces on the screen must be the active trace, and any changes to the trace setup are executed for the active trace. The active trace is changed in sequential order by pressing the **Trace** key of “4. Measurement block (MEASUREMENT)” on page 23.

## 6. Trace 2

This is one of the traces that can be displayed simultaneously on the E4991A. The bar indicating the trace and scale colors of Trace 2 as well as the measurement parameter names and their units (in this example,  $\theta_z$  [ $^\circ$ ]) are displayed in the upper-middle area.

## 7. Markers

These are used to read the values on a trace as numeric values. The value at each marker position is displayed in the “3. Marker values” on page 34.

## 8. Scale reference line value

This displays the value of the scale reference line, which is a horizontal dotted line displayed in the same color as the corresponding trace.

## 9. Trace 1 axis

This displays the axis and scale of Trace 1.

## 10. Sweep start value

This displays the current sweep start value.

## 11. Sweep stop value

This displays the current sweep stop value.

## 12. Trace 2 axis

This displays the axis and scale of Trace 2.

### 13. Status bar

This displays the E4991A status information that is critical for the instrument's operation.

Indicator	Description
<b>Bias OFF</b>	dc bias is not being applied.
<b>Bias ON</b>	dc bias is being applied.
<b>Bias Lmt</b>	dc bias output is clamped to the current or voltage limit.
<b>Uncal</b>	Calibration is off.
<b>Cal Fix</b>	Calibration is on in fixed frequency/fixed power point mode.
<b>Cal FixR</b>	Calibration is on in fixed frequency/user-defined power point mode.
<b>Cal User</b>	Calibration is on in user-defined frequency/user-defined power point mode.
<b>Comp OFF</b>	Compensation is off.
<b>Comp ON</b>	Compensation is on.
<b>Del xxx</b>	Fixture electrical length compensation is applied. (A numeric value was set for the electrical length of the test fixture.) <b>xxx</b> represents the currently entered electrical length value in meters. For example, <b>Del 10m</b> indicates that the fixture's electrical length is set to 10 millimeters.
<b>Avg xx</b>	The point averaging factor is set to xx.
<b>Hold</b>	The trigger is on hold.
<b>Manual</b>	Waiting for manual trigger.
<b>External</b>	Waiting for external trigger.
<b>GPIB Bus</b>	Waiting for GPIB trigger (trigger command).
<b>ExtRef</b>	The "8. External reference signal input terminal (Ext Ref In, 10 MHz 0 dBm)" on page 30, and the E4991A test signal are phase-locked to a reference signal.
<b>Svc</b>	<p>The E4991A is in the service mode. Because this mode is designed for use in self-diagnosis or repair of the E4991A, the measurement performance guaranteed in the specification is not obtained. If this indicator is on in the usual operation mode, the E4991A may have experienced at failure.</p> <p>After executing a diagnostic operation, <b>Svc</b> will appear on the display. You must shutdown and restart the E4991A before making measurements.</p>

**Names and Functions of LCD Display Areas**

<b>Indicator</b>	<b>Description</b>
<b>Ovld</b>	An overload occurred in the measurement circuit. One or more measurement values are invalid. This indicator goes on when the device under test is removed or installed during measurement.

---

## 3 Setting Measurement Conditions

This chapter describes the method used to set up the measurement conditions (test signal and sweep) for the Agilent E4991A impedance/material analyzer.

## Initialization of E4991A (presetting)

The E4991A has an initialization state called the “Preset State.”

It is always possible to return the E4991A to its preset state by taking one of the following actions:

- Right-click to open the shortcut menu, and click **Preset-Execute**.
- Click **System-Preset** from the menu bar.
- Press  in the **SYSTEM** block on the front panel.

For more details on the E4991A’s initial settings, including the preset state, refer to Chapter G, “Initial Settings,” on page 439.



## Setting Material Measurement Parameter (Option 002 only)

When you take a material measurement (permittivity or permeability measurement) with the E4991A and “Option 002 material measurement,” the following setups must first be completed.

### Procedure

#### Step 1. Select the type of material measurement

- a. Right-click to open the shortcut menu and click **Utility** (or press Utility).
- b. Click the **Material Option Menu** button.
- c. Click to open the **Material Type** box and click on the material measurement type.

Material Type Box	Material Measurement Type
<b>Impedance</b>	Impedance measurement (measurement of general impedance parameters except for permittivity and permeability).
<b>Permittivity</b>	Permittivity measurement
<b>Permeability</b>	Permeability measurement

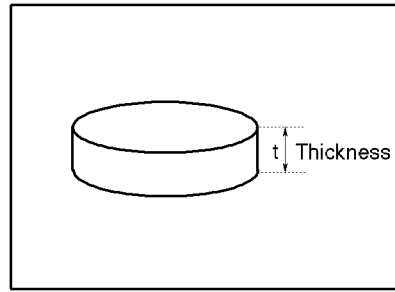
#### Step 2. Enter material dimensions

Using the numeric entry dialog box that appears by right-clicking inside the setting box described below (or using the **ENTRY/NAVIGATION** block key of the front panel), enter the necessary material dimensions:

Material Dimension Setting Box	Value to Enter
<b>Thickness</b>	Thickness of dielectric material $t$ [m] (see Figure 3-1)
<b>Height</b>	Height of magnetic material $h$ [m] (see Figure 3-2)
<b>Inner Diameter</b>	Inner diameter of magnetic material $b$ [m] (see Figure 3-2)
<b>Outer Diameter</b>	Outer diameter of magnetic material $c$ [m] (see Figure 3-2)

Figure 3-1

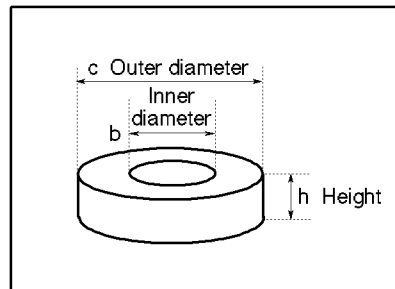
Material shape parameter for dielectric material



e4991a0e112

Figure 3-2

Material shape parameter for magnetic material





e4991a0e111

## Selection and Confirmation of Target Trace (Active Trace)

It is necessary to first select a target trace to set among the multiple traces shown on the display. This target trace is referred to as the “Active Trace.”


### Selecting Active Trace

You can select the active trace by taking any of the following actions:

- In the split display mode, click inside the window frame of the trace you want to activate.
- In a overlay display mode, click the name area of the measurement parameter (e.g. **2:  $\theta z$  [°]**) or click the measurement value axis (vertical axis) of the trace you want to activate. If you place the cursor in this area, it will change from  to .
- Right-click to open the shortcut menu and click **Trace-Scaler #** or **Trace-Complex # (# indicates trace number)**.
- Click **Trace-Scaler #** or **Trace-Complex # (# indicates trace number)** from the menu bar.
- Press **Trace** in the **MEASUREMENT**-block on the front panel (each press changes the active trace in sequential order).

### Identifying Active Trace

The selected active trace can be identified in the following ways:

- An asterisk (“\*”) appears to the left of the name area of the active trace’s measurement parameter (e.g. **2:  $\theta z$  [°]**).
- The active trace’s number is indicated in a window at the top of five setup toolbars: **Meas/Format, Scale, Display, Marker, Marker Function**.  
Active trace number  

- The active trace is indicated together with its number in the title area (at the top of the display) in the preset state.

#### NOTE

An operation done in a setup tool bar where the active trace number is not displayed shall be executed not for a particular trace but commonly for all traces on the display.

---

## Selecting Sweep Parameter

The sweep parameter of the source can be selected from among frequency, source power (level), dc bias voltage and current.

---

**NOTE**

Option 001 must be installed to sweep by dc bias voltage or current.

### Procedure

- Step 1.** Right-click to open the shortcut menu and click **Sweep Setup** (or press ).
- Step 2.** Click and open the **Sweep Parameter** box and click to select the sweep parameter.

Sweep Parameter box	Sweep Parameter
Frequency	Frequency
Power	Source power (level)
Bias Voltage	dc bias voltage (option 001 only)
Bias Current	dc bias current (option 001 only)

---

## Using Time as Sweep Parameter (Zero Span Sweep)

Measurement using time as the sweep parameter can be executed by setting the sweep parameter to zero. This sweep is called Zero Span sweep.

### Procedure

#### Step 1. Set the sweep span to zero:

- a. Right-click to open the shortcut menu and click **Start/Stop** (or press ).
- b. Using the numeric entry dialog box by right-clicking inside the **Span** box (or using the **ENTRY/NAVIGATION** block keys on the front panel), enter zero as the sweep span value.

#### Step 2. Set sweep time:

- a. Right-click to open the shortcut menu, and click **Sweep Setup** (or press ).
- b. Click the **Sweep Time** button.
- c. Using the numeric entry dialog box by right-clicking inside the **Sweep Time** box (or using the **ENTRY/NAVIGATION** block keys on the front panel), enter the sweep time (i.e., sweep span in the time sweep).

---

#### NOTE

If the number of measurement points is set to the maximum value (801), the sweep time can be set up to 16,080 second (approximately 4.5 hours).

## Selecting Sweep Type (Linear/Log/Segment)

You can select the sweep type by following the procedure below.

### Procedure

- Step 1.** Right-click to open the shortcut menu and click **Sweep Setup** (or press **Sweep**).
- Step 2.** Right-click to open the shortcut menu and click to select the **Sweep Type** box.

Sweep Type Box	Sweep Type
Linear	Linear sweep
Log	Log sweep
Segment	Segment sweep

---

### NOTE

When the oscillator level (power) or dc bias has already been selected as a sweep parameter, the sweep type is fixed to linear sweep and cannot be changed. For more details on selecting the sweep parameter, see “Selecting Sweep Parameter” on page 46.

If the segment sweep table has not been prepared, the segment sweep cannot be selected (when the segment sweep table has been not prepared, the **Segment** is not displayed, even if the **Sweep Type** box is opened). For more details on preparing the segment sweep table, see “Sweeping a Plural Number of Sweep Areas under Different Conditions at One Time (Segment Sweep)” on page 66.

---

---

## Selecting Sweep Direction

The characteristics of a device under test (DUT) having the hysteresis feature for sweep parameter can be observed from the appropriate sweep direction.

You can select the sweep direction by following the procedure below.

### Procedure

- Step 1.** Right-click to open the shortcut menu and click **Sweep Setup** (or press **Sweep**).
- Step 2.** Click the **Sweep Direction** button and select the Sweep Direction.

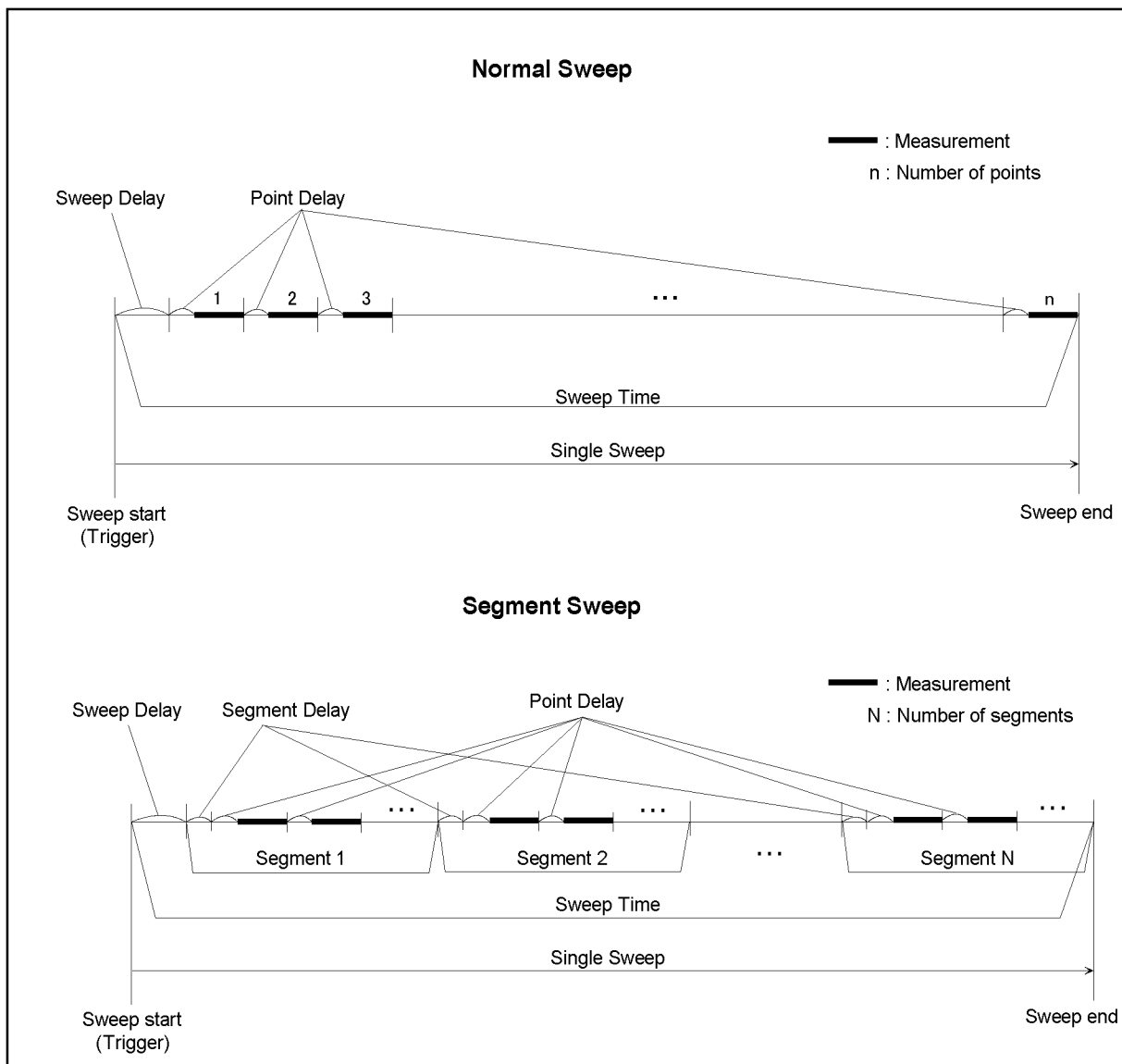
Sweep Direction Button	Sweep Direction Setup
Sweep Direction [Up]	Upward (in the direction from sweep start value to sweep stop value)
Sweep Direction [Down]	Downward (in the direction from sweep stop value to sweep start value)

## Measurement Waiting Time/Sweep Time Setting

A time delay can be set for the period after the sweep is triggered but before the actual sweep starts (sweep delay). Furthermore, a time delay can also be set for the period after a signal is applied to a DUT but before actual measurement starts (point delay). This function is useful, for example, when a certain period is required before the characteristics of the DUT can become stable after a signal is applied. Another application of this function is to observe the changes in a DUT's impedance over time for a long span.

Figure 3-3 shows the definitions of sweep time, sweep delay time, point delay time, and segment delay time.

Figure 3-3 Definition of measurement waiting time



e4991aee176



### Procedure

- Step 1.** Right-click to open the shortcut menu and click the **Sweep Setup** (or press Sweep).
- Step 2.** Click the **Sweep Setup** button.
- Step 3.** Using the numeric entry dialog box by right-clicking inside the **Sweep Time** box (or using the **ENTRY/NAVIGATION** block key on the front panel), enter the sweep or delay time.

Sweep Time Setting Box	Input Value
<b>Sweep Time</b>	Sweep time (time period for an entire sweep)
<b>Point Delay</b>	Point delay time (time delay for each measurement point)
<b>Segment Delay</b>	Segment delay time (time delay for each segment).
<b>Sweep Delay</b>	Sweep delay time (time delay for each sweep).

Setting the time period for an entire sweep (**Sweep Time**) makes it possible to automatically set equal time delays at a measurement point (**Point Delay**).

When the measurement point delay time (**Point Delay**), segment delay time (**Segment Delay**), or sweep delay time (**Sweep Delay**) is changed, the sweep time (**Sweep Time**) setting is automatically changed.

---

**NOTE**

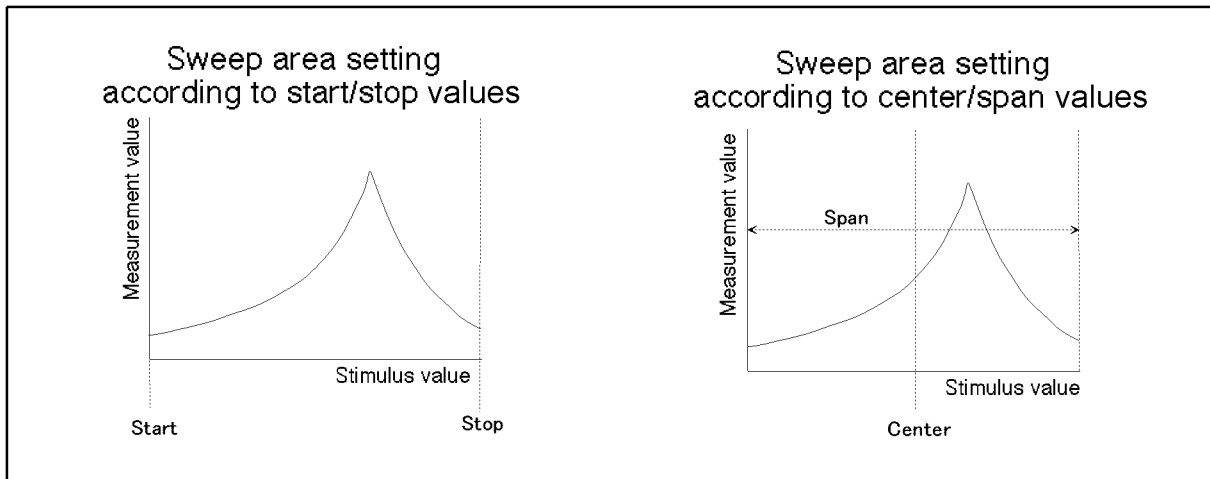
Segment delay time is only effective when the sweep type is set to segment sweep. For details on segment sweep, refer to “Sweeping a Plural Number of Sweep Areas under Different Conditions at One Time (Segment Sweep)” on page 66.

---

## Setting Sweep Range

There are two ways to set the sweep area. One is setting according to the start and stop values, and the other is setting according to the center and span values.

Figure 3-4 Sweep Area Setting



e4991a0e110











### Procedure

- Step 1.** Right-click to open the shortcut menu and click **Start/Stop** (or press ).
- Step 2.** When setting the sweep area according to Start/Stop values, change the values in the **Start** box and **Stop** box in the tool bar. When setting the sweep area according to Center/Span values, change the values in the **Center** box and **Span** box in tool bar.

Sweep Area Setting Box	Input Value
<b>Start</b>	Sweep start value.
<b>Stop</b>	Sweep stop value.
<b>Center</b>	Sweep center value.
<b>Span</b>	Sweep span value.

You can use any of the following methods to change the value in the box:

- Right-click in the box and enter the set value by clicking the numerical and unit buttons that appear.
- Click the up or down (s or t) button to increase or decrease the sweep area setting value.
- After all character strings in a box have been selected (displayed in reverse), press the keys in the **ENTRY/NAVIGATION** block to enter the sweep area setting value. To set up the sweep start value of 100 MHz, for example, press     in the **Start** box one-by-one.

- When all character strings in the box are selected (displayed in reverse), place the cursor at the top of the character string by pressing  or  and pressing the up and down   buttons or turning the rotary knob  to increase and decrease the sweep area setting value.
- When all character strings in the box are selected (displayed in reverse), enter the sweep area setting value with the external keyboard. To enter the sweep start value of 100 MHz, for example, press     (“M” should be typed as a capital letter) in the **Start** box and finish the entry by pressing .

---

**NOTE**

If you enter the sweep start and sweep stop values, the sweep center and sweep span values will be automatically calculated based on those values and displayed in their respective boxes. On the other hand, if you enter the sweep center and sweep span values, the sweep start and sweep stop values will be automatically calculated based on the entered sweep center and sweep span values and displayed in their respective boxes.

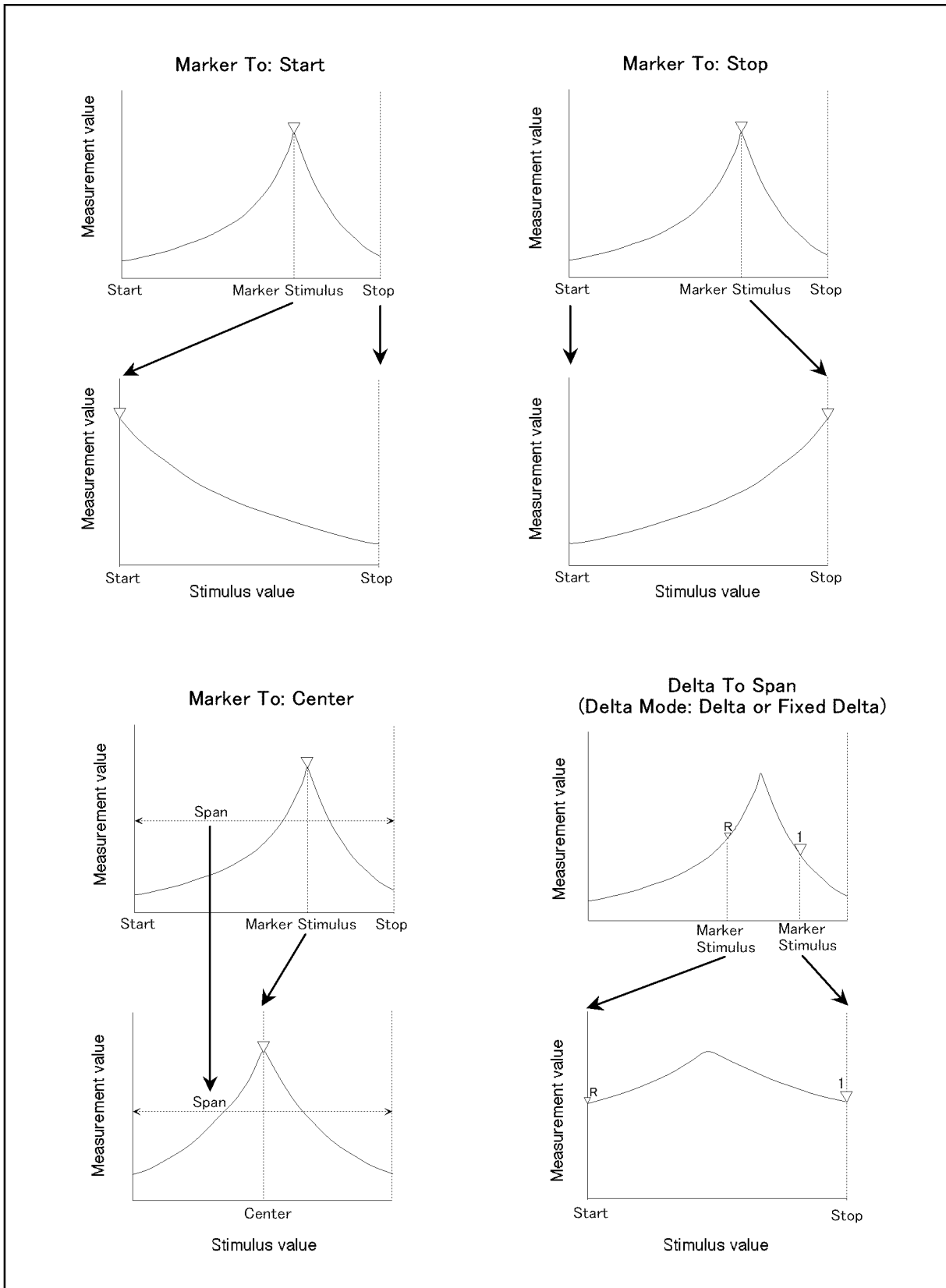
You cannot set up a sweep start value that is larger than the sweep stop value. If you want to sweep from a higher to a lower value, you should first set up the sweep area from a lower to a higher value and then set the sweep direction to “[Down].” For details on setting the sweep direction, see “Selecting Sweep Direction” on page 49.

---

## **Setting Sweep Area with Marker**

You can assign the position of the active marker on a trace (stimulus value) in the same way as setting sweep start value, sweep stop value, or sweep center value. It is also possible to assign the distance between Marker R and Marker 1 (or 2 - 8), which is the difference between stimulus values, in the same way as setting sweep span value (Figure 3-5).

Figure 3-5 Sweep Area Setting with the Marker



e4991aoe107

## Setting Measurement Conditions

### Setting Sweep Area with Marker

#### Procedure

- Step 1.** Place the active marker on the new sweep start, sweep stop, or sweep center. To set a sweep span, place Marker R and Marker 1 (or 2-8) on the trace points corresponding to the new sweep span and set the marker delta mode to delta or fixed delta. At this time, set Marker 1 (or 2-8) to active status (marker display:  $\nabla$ ). For details on how to use the marker, see Chapter 6, “Analysis of Measurement Results,” on page 127.
- Step 2.** Right-click to open the shortcut menu and click **Marker** (or press **Marker**).
- Step 3.** Click the **Marker To Menu** button.
- Step 4.** Set the position (distance) of markers on a new sweep area by clicking any of the following buttons for assigning marker values.

Button Assigning Marker Value	Sweep Area Display Mode
<b>Start</b>	Assign the stimulus value of the active marker as the sweep start value. As a result, the position of the marker establishes a new sweep start point.
<b>Stop</b>	Assign the stimulus value of the active marker as the sweep stop value. As a result, the position of the marker establishes a new sweep stop point.
<b>Center</b>	Assign the stimulus value of the active marker as the sweep center value. As a result, the position of the marker establishes a new sweep center point.
<b>Delta To Span</b>	For Marker R and the active marker (one of Markers 1 to 8), the smaller marker stimulus value is assigned as the sweep start value and the larger one is assigned as the sweep stop value. As a result, the sweep range between Marker R and the active marker establishes a new sweep span.

---

**NOTE**

After the sweep area is changed, no trace is displayed in the new sweep area until a new measurement is taken.

---

---

## Setting Number of Points (NOP)

The number of points (NOP) per sweep is set by following the procedure below.

### Procedure

- Step 1.** Right-click to open the shortcut menu and click **Sweep Setup** (or press ).
- Step 2.** Using the numeric entry dialog box that appears by right-clicking inside the **Number Of Points** box (or using the **ENTRY/NAVIGATION** block keys on the front panel), enter the number of points.

---

### NOTE

Number of points can be set as an integer from 2 to 801.

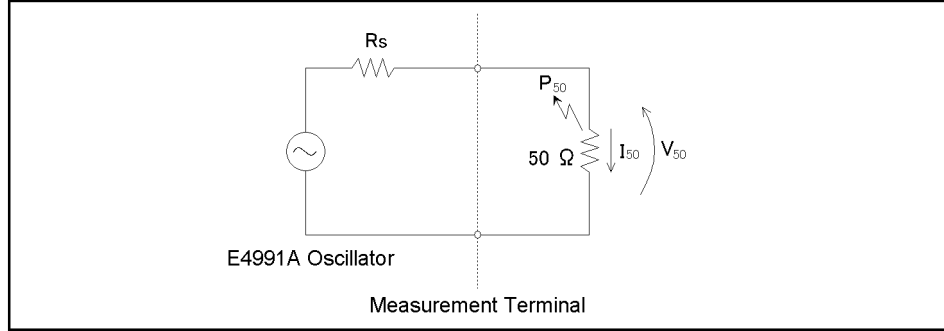
Number of points is set by the segment sweep table when the sweep type is segment (segment sweep). For setting the segment sweep table, see “Sweeping a Plural Number of Sweep Areas under Different Conditions at One Time (Segment Sweep)” on page 66.

---

## Oscillator Level Setting

### Definition of Oscillator Level Setting

When oscillator is not the sweep parameter (i.e., it's a fixed parameter), the oscillator unit can be selected from power (dBm), voltage (V) or current (A) depending on the oscillator level setting. Oscillator level units and the definition of their setting values are given below.



e4991a0e203

Oscillator Level Unit (Osc Unit)	Definition of Oscillator Level Setting Value
Power [dBm]	Power level $P_{set}$ is equivalent to the power level $P_{50}$ consumed in the $50 \Omega$ resistor connected to the measurement terminal ( $P_{set} = P_{50}$ ).
Voltage [V]	Voltage value $V_{set}$ is twice the value of $V_{50}$ when the measurement terminal is connected to the $50 \Omega$ resistor ( $V_{set} = V_{50} \times 2$ ). This value is approximately equal to the voltage when the measurement terminal is open <sup>*1</sup> .
Current [A]	Current value $I_{set}$ is twice the value of $I_{50}$ when the measurement terminal is connected to the $50 \Omega$ resistor ( $I_{set} = I_{50} \times 2$ ). This value is approximately equal to the current when the measurement terminal is shorted <sup>*2</sup> .

\*1. When measuring a DUT having a value of  $Z_x [\Omega]$ , you can calculate the voltage  $V_x [V]$  actually applied to the DUT as follows.

$$V_x = V_{set} \times \frac{Z_x}{Z_x + 50} \quad (V_{set}: \text{Setting value of the oscillator level [V]})$$

\*2. When measuring a DUT having a value of  $Z_x [\Omega]$ , you can calculate the current  $I_x [A]$  actually flowing into the DUT as follows.

$$I_x = I_{set} \times \frac{50}{Z_x + 50} \quad (I_{set}: \text{Setting value of the oscillator level [A]})$$

The accuracies of the levels calculated by Equations \*1 and \*2 are as follows.



$$\pm \left[ 30 + \left( 10^{\frac{A}{20}} - 1 \right) \times 100 + B \right] [\%] \text{ (Typical)}$$

A: oscillator level accuracy [dB]

B: impedance measurement accuracy [%]

### Procedure

Follow the procedure below to specify a fixed oscillator level (AC level) when the sweep parameter is any item other than oscillator level (i.e., frequency or dc bias).

#### Step 1. Selecting oscillator level unit

- a. Right-click to open the shortcut menu, and click **Source** (or press Source).
- b. Click and open the **Osc Unit** box and select the desired oscillator level unit.

Osc Unit Box	Oscillator Level Unit
Power	Power (dBm)
Voltage	Voltage (V)
Current	Current (A)

#### NOTE

The oscillator level unit that you set is used for sweeping the oscillator level and also for setting the fixed oscillator level, which is used for sweeping any parameter other than oscillator level.

#### Step 2. Oscillator Level Setting

Using the numeric entry dialog box that appears by right-clicking inside the **Osc Level** box (or using the **ENTRY/NAVIGATION** block keys on the front panel), enter the Osc level.

For example, use the **ENTRY/NAVIGATION** block keys to enter the oscillator level of -10 dBm by pressing +/- to delete the character string in the box and then pressing +/- 1 0 Enter.

#### NOTE

For more details on the entry area for the oscillator level and resolution, see “Specification and Reference Data.”

---

## Setting and Applying dc Bias

Follow the procedure below to apply dc bias to the DUT.

### Procedure

---

#### CAUTION

*Whenever you connect a DUT to or disconnect it from the E4991A for measurement, you must first turn off the dc bias or set the sweep to the hold state (in sweep hold state, dc bias is not applied to the DUT). If this step is not taken, the dc bias may destroy the device.*

---

#### Step 1. Select the dc Bias Mode:

- a. Right-click to open the shortcut menu and click **Source** (or press **Source**).
- b. Click to open the **Bias Source** box and then click to select the dc Bias Mode:

Bias Source Box	dc Bias Mode
Current	Current Source
Voltage	Voltage Source

#### Step 2. Set the dc Bias Level

Use the numeric entry dialog box that appears by right-clicking inside the **Bias Level** box (or the **ENTRY/NAVIGATION** block keys on the front panel) to enter the dcBias level.

#### Step 3. Set the dc Bias Limit

Use the numeric entry dialog box that appears by right-clicking inside the **Bias Limit** box (or the **ENTRY/NAVIGATION** block keys on the front panel) to enter the dc Bias Limit value.

#### Step 4. Apply dc Bias

- a. Click the **dc Bias** button and turn the dc Bias on.  

If this operation is made during a sweep measurement, the sweep mode will automatically stop the sweep. dc Bias will not be applied after the sweep is stopped.
- b. Execute sweep measurement according to the operating procedures described in “Single Sweep, Continuous Sweep and Sweep Stop” on page 63.

#### Step 5. Monitor dc Bias Level

The level of dc bias applied to the DUT can be displayed by the following procedure.

- a. Right-click to open the shortcut menu and click **Source** (or press **Source**).
- b. Click the **Bias Monitor** button and turn the dc bias level monitor on.
- c. Right-click to open the shortcut menu and click **Marker**.

Marker 1 appears on the trace and the dc bias level monitor value at the marker point is displayed at the top of the screen area. For more details on setting and using markers, refer to Chapter 6, “Analysis of Measurement Results,” on page 127.

---

## Setting the Trigger Source To Start Sweep

Set up the signal source to execute sweep start (i.e., the trigger source) by following the procedure below.

### Procedure

- Step 1.** Right-click to open the shortcut menu and click **Trigger Setup** (or press ⌘ **Trigger Setup**).
- Step 2.** Click to open the **Trigger Source Box** and select the desired trigger source.

Trigger Source Box	Trigger Source
<b>Internal</b>	Internal continuous trigger generated automatically by the E4991A.
<b>Manual</b>	Manual trigger generated by clicking the <b>Manual Trigger</b> button on the <b>Trigger Setup</b> toolbar or by pressing <span>⌘</span> <b>Trigger</b> *1.
<b>External</b>	External trigger implemented upon detecting TTL signal coming into external trigger input connector of rear panel.
<b>GPIB Bus</b>	GPIB trigger implemented by trigger command to start measurement sent via GPIB.

\*1. The manual trigger can also be executed by clicking **Trigger-Trigger** from the menu bar or by clicking **Trigger** from the shortcut menu displayed by pressing the right button.

---

### NOTE

For more details on the characteristics of the signal for an external trigger, see “Chapter 11, “Specifications and Supplemental Information,” on page 237.”

For more details on using GPIB, see *Programming Manual*.

---

## Selecting Trigger Target (Trigger Event)

You may select the target for trigger generation (trigger event) from single sweep (sweep trigger), one-point measurement (measurement point trigger), or one-segment measurement (segment trigger).

---

**NOTE**

The trigger event is fixed to **On Sweep** and cannot be changed when **Internal** is selected as the trigger source in “Setting the Trigger Source To Start Sweep” on page 61.

### Procedure

- Step 1.** Right-click to open the shortcut menu and click **Trigger Setup** (or press **Trigger Setup**).
- Step 2.** Click and open the **Trigger Event** Box and click to select the desired Trigger Event.

Trigger Event List	Trigger Event
<b>On Sweep</b>	Sweep trigger (single sweep is made with each trigger).
<b>On Point</b>	Measurement point trigger (one point is measured with each trigger).
<b>On Segment</b>	Segment trigger (one segment is measured with each trigger).

---

**NOTE**

It is necessary to prepare a segment sweep table before using a segment trigger. For more details on preparing a segment sweep table, see “Sweeping a Plural Number of Sweep Areas under Different Conditions at One Time (Segment Sweep)” on page 66.

---

## Single Sweep, Continuous Sweep and Sweep Stop

You may select the type of sweep execution upon trigger generation from single sweep, continuous sweep, and sweep stop.

### Procedure

- Step 1.** Right-click to open the shortcut menu and click **Trigger Setup** (or press ).
- Step 2.** Select the sweep mode by clicking one of the three buttons for sweep mode selection.

Sweep Mode Selection button	Sweep Mode
<b>Hold</b>	Sweep stop (sweep is immediately stopped and not restarted even if a trigger is generated).
<b>Single</b>	Single sweep (single sweep is triggered and when the sweep finishes Sweep Stop mode is invoked; if you press this button during the sweep, this sweep is stopped and a new single sweep is executed).
<b>Continuous</b>	Continuous sweep (sweep is continuously repeated by trigger generation).

---

#### NOTE

A check mark (✓) to the left of the sweep mode selection button indicates the mode that is currently selected and executed.

---

## Selecting Polarity of External Trigger Input Signal

You can select the polarity for trigger signal detection by the external trigger input connector on the rear panel by following the procedure below.

### Procedure

- Step 1.** Right-click to open the shortcut menu and click **Trigger Setup** (or press `Trigger Setup`).
- Step 2.** Click the **Trigger Polarity** Button and select the external trigger signal polarity.

Trigger Polarity Button	External Trigger Signal Polarity
<b>Positive</b>	Positive polarity (detects increasing TTL signal and triggers).
<b>Negative</b>	Negative polarity (detects decreasing TTL signal and triggers).

---

## CW Frequency Setting

When you set the sweep parameter to one other than frequency (source level, dc bias voltage, or dc bias current), set the fixed measurement frequency (CW frequency) by following the procedure below.

---

### NOTE

When the sweep parameter is set to frequency, it is not possible to set CW frequency. In order to set CW frequency, you should preset the sweep parameter to one other than frequency according to “Selecting Sweep Parameter” on page 46.

---

### Procedure

- Step 1.** Right-click to open the shortcut menu and click **Source** (or press **Source**).
- Step 2.** Using the numeric entry dialog box that appears by right-clicking inside the **CW Freq** box (or using the **ENTRY/NAVIGATION** block keys on the front panel), enter the CW frequency.

For example, to set the CW frequency, click **100M** in the numeric entry dialog box (or press **1** **0** **0** **M/μ** one-by-one with the **ENTRY/NAVIGATION** block keys on the front panel).

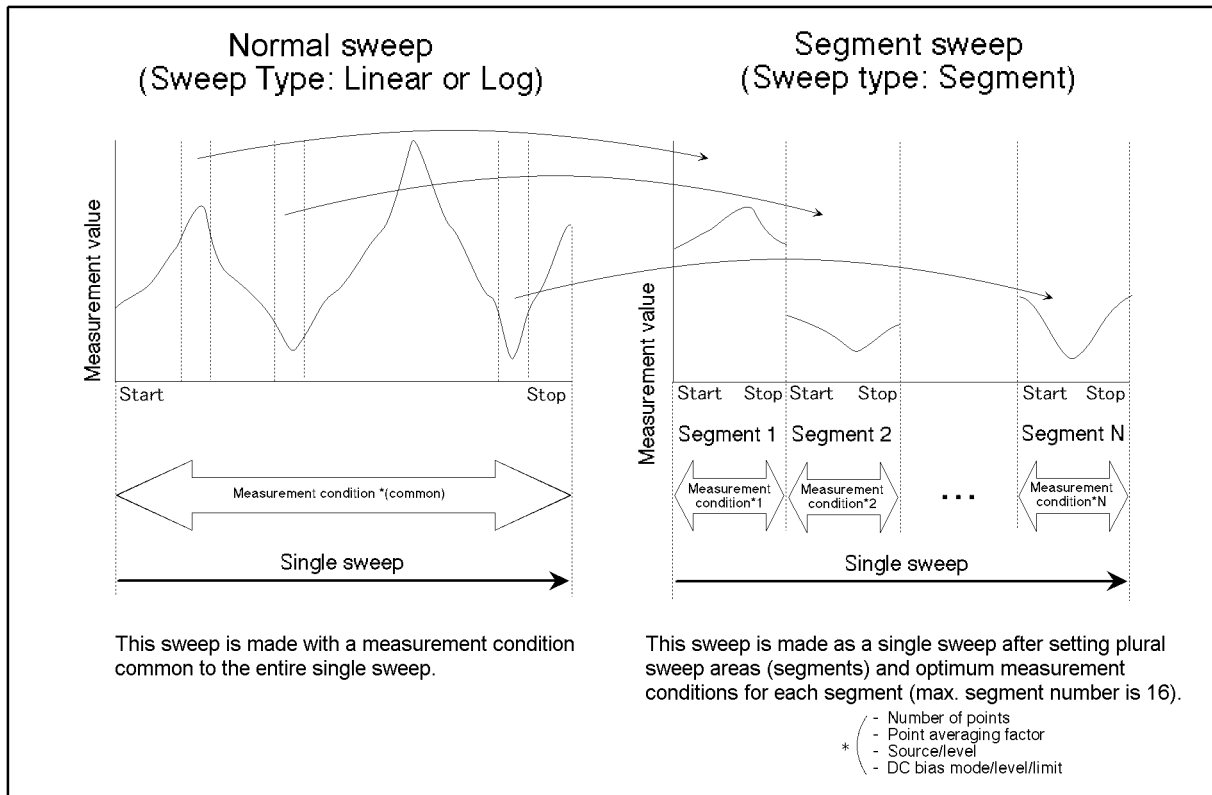
## Sweeping a Plural Number of Sweep Areas under Different Conditions at One Time (Segment Sweep)

When linear sweep or log sweep is selected as the sweep type in frequency sweep, certain measurement conditions like the point averaging factor and the oscillator level are uniform over the entire single sweep. Consequently, it is not possible to change such settings for a particular area.

In segment sweep, on the other hand, a plural number of frequency areas, which are called “segments,” can be individually set by users. In this case, certain measurement conditions (i.e., number of points, point averaging factor, source unit/oscillator level, DC bias mode/level/limit) can be set for each segment, and the entire series of such segment setups can be sequentially executed as a single sweep (Figure 3-6).

By using this feature, it is possible to take a sweep measurement in only the desired area and to skip the frequency areas that you do not need to measure. It is also possible to set optimal measurement conditions for each designated segment. For example, you can increase the point averaging factor and number of points for segments that require measurements with higher stability and more accurate frequency resolution (as resonance point). For segments without such stringent measurement requirements, you can set the conditions to enable high-speed measurement.

Figure 3-6 Concept of Segment Sweep



e4991a0e108



## Procedure

### Step 1. Preparation of segment table

- a. Right-click to open the shortcut menu and click **Sweep Setup** (or press Sweep).
- b. Click the **Segment Table Menu** button.  
 The segment sweep setup table (Figure 3-7) is displayed.

Figure 3-7

Segment Sweep Setup Table

- c. Click the **Add Segment** button to add a new segment in the Segment Sweep Table.

The default values for the first segment are listed in the Sweep columns of Chapter G, “Initial Settings,” on page 439. When the table already has segments, the last segment in the table is copied to create a new segment.

- d. Edit the added segment using the following buttons and boxes.

Segment Sweep Setting Button/Box	Setting Function
<b>Start</b> spin box	This sets sweep start frequency of segment.
<b>Stop</b> spin box	This sets sweep stop frequency of segment.
<b>Number Of Points</b> spin box	This sets number of points of segment.
<b>Point Average</b> spin box	This sets point averaging factor of segment.
<b>Delete Segment</b> button	This deletes the segment designated in the <b>Segment No.</b> box from the table.

## Setting Measurement Conditions

### Sweeping a Plural Number of Sweep Areas under Different Conditions at One Time (Segment Sweep)

Segment Sweep Setting Button/Box	Setting Function
<b>More</b> button	This opens the toolbar showing the buttons described below.
<< button	This returns to the toolbar showing the buttons described above.
<b>Osc Level</b> spin box	This sets source level of segment.
<b>Osc Unit</b> list box	This selects source level unit in segment sweep from among <b>Power</b> , <b>Voltage</b> and <b>Current</b> . <sup>*1</sup>
<b>Bias Level</b> spin box	This sets DC bias level of segment.
<b>Bias limit</b> spin box	This sets DC bias limit of segment.
<b>Bias Source</b> list box	This selects either <b>Voltage</b> or <b>Current</b> as DC bias mode in segment sweep. <sup>*1</sup>

\*1. This is a setting common to all segments (cannot be set individually for each segment).

To change the numeric value in a spin box, right-click in the box to open and use the numeric entry dialog box, or use the **ENTRY/NAVIGATION** block keys on the front panel.

To select an item in a box, click to open the box and then click to select the item.

The maximum number of segments in a table is 16. The maximum number of measurement points in the entire table is 801.

- e. Repeat step c and step d to complete the required segments.

To modify one of the created segments, enter the segment number in the **Segment No.** spin box and edit the segment in accordance with step d.

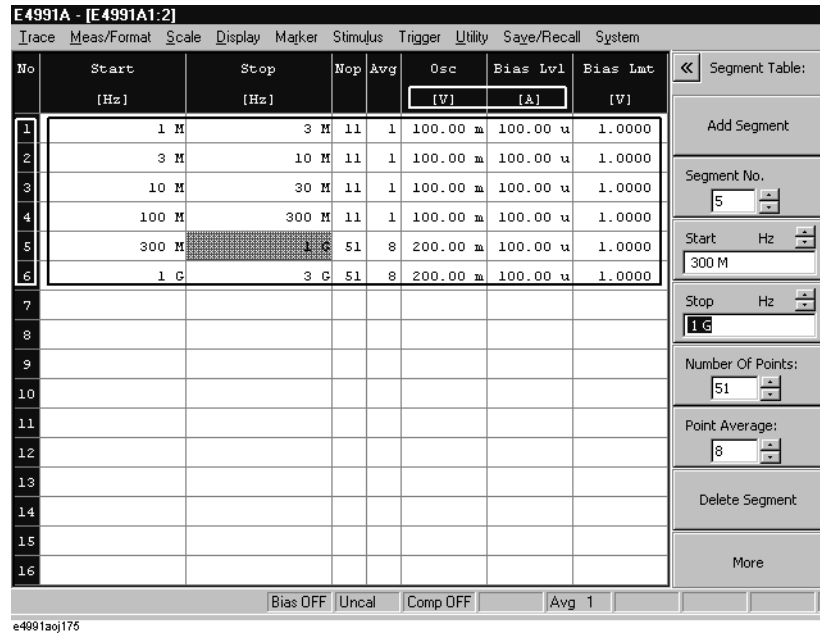
---

#### NOTE

You can directly call up the setup box for changing an item's value by clicking the current value in the segment table on the screen (Figure 3-7).

Figure 3-8

Area to Click and Call Setup Box (Inside the Frame)



**Step 2. Selecting segment as a sweep type**

- a. Right-click to open the shortcut menu and click **Sweep Setup** (or press **Sweep**).
- b. Click to open the **Sweep Type** box and then select **Segment** (Segment Sweep).

**Step 3. Setting a graph's horizontal axis in the segment sweep**

Click the **Segment Display** button and select the appropriate setting for the graph's horizontal axis by referring to the table below (See Figure 3-9).

**Segment Display Button**

**Graphic Horizontal Axis Display**

**Segment Display [Order Base]**

Order base (defines the horizontal axis at equal intervals in order of measurement).

**Segment Display [Freq Base]**

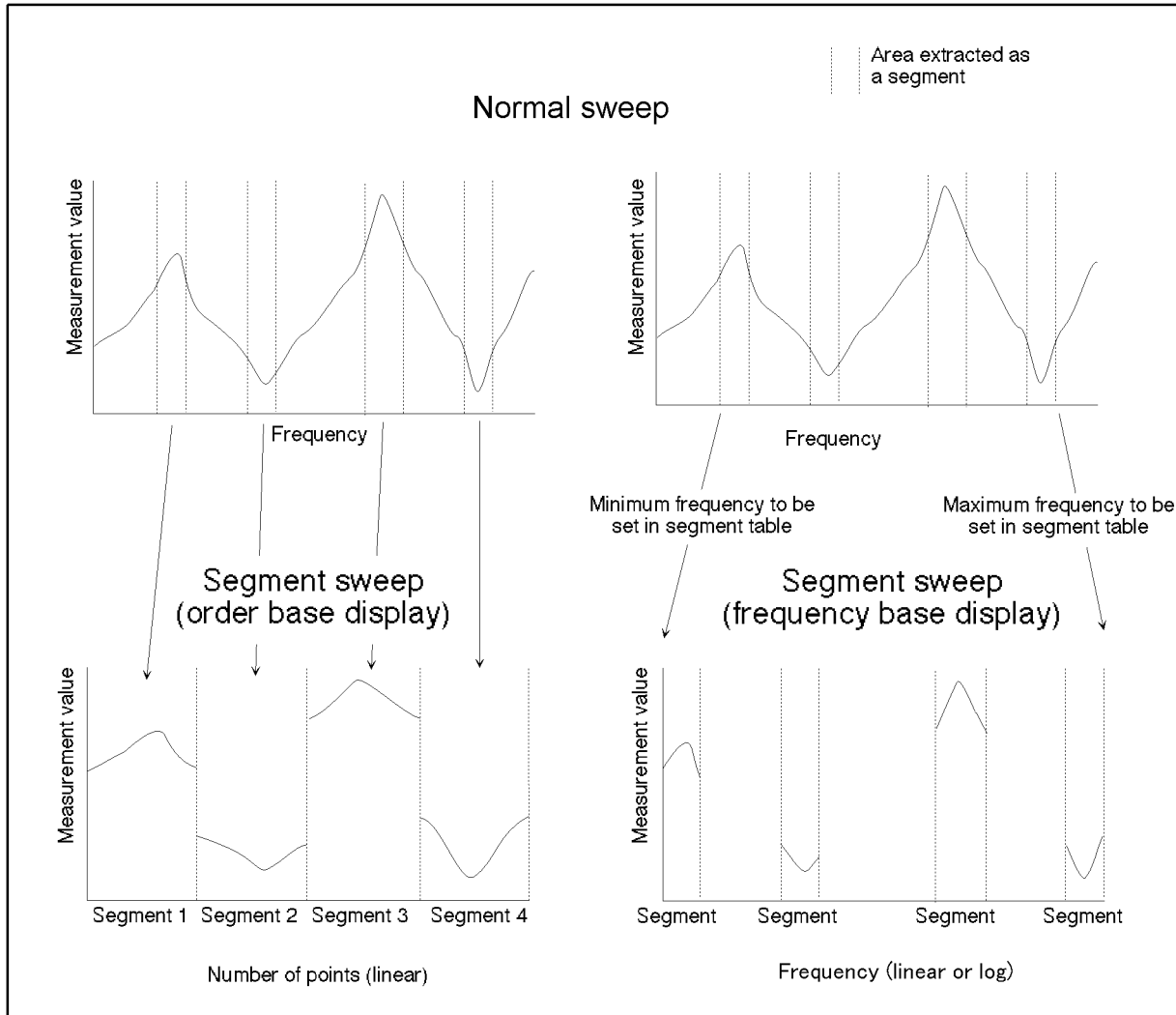
Frequency base (defines the horizontal axis as a linear frequency axis with the minimum frequency at the left end and the maximum frequency at the right end of the sweep table).

**Segment Display [Log Freq Base]**

Log frequency base (defines the horizontal axis as a log frequency axis with the minimum frequency at the left end and the maximum frequency at the right end of the sweep table).

Setting Measurement Conditions  
 Sweeping a Plural Number of Sweep Areas under Different Conditions at One Time (Segment Sweep)

Figure 3-9 Order Base Display and Frequency Base Display



e4991a0e109

## Averaging Measurement Results

### Averaging Plural Sweeps (Sweep-to-Sweep Averaging)

Sweep-to-sweep averaging means to average the data (vector quantities) of all points based on the index average of a continuous sweep weighed with an averaging factor designated by the user. Sweep-to-sweep averaging is performed according to Equation 3-1:

**Equation 3-1** Sweep-to-sweep averaging calculation formula

$$A_n = \frac{S_n}{F} + \left(1 - \frac{1}{F}\right) \times A_{n-1}$$

where:

$A_n$  = Calculation result of sweep-to-sweep averaging from n-times sweeping at the measurement point (vector quantity).

$S_n$  = Measurement value from n-times sweeping at the measurement point (vector quantity).

F = Sweep-to-sweep averaging n-times.

Set the sweep-to-sweep averaging by following the procedure below.

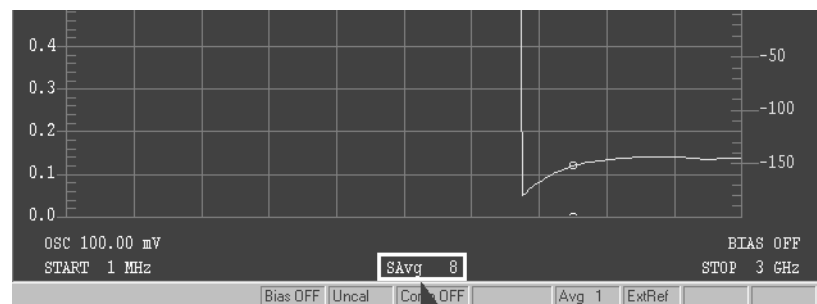
#### Procedure

- Step 1.** Right-click to open the shortcut menu and click **Meas/Format** (or press **Meas/Format**).
- Step 2.** Click the **Sweep Average** button to turn the sweep-to-sweep averaging on.
- Step 3.** Enter the number of times for sweep-to-sweep averaging with the numeric entry dialog box that appears by right-clicking inside the **Swp Avg Count** box or with the **ENTRY/NAVIGATION** block keys on the front panel.

For example, to set the sweep-to-sweep averaging number of times to 8, click **8** and **Enter** in the numeric entry dialog box (or press **8** **Enter**) using the **ENTRY/NAVIGATION** block keys on the front panel).

**Figure 3-10**

#### Displaying Sweep-to-Sweep Averaging Counter



Sweep-to-Sweep Averaging Counter

Setting Measurement Conditions  
**Averaging Measurement Results**

---

**NOTE**

You may set the number of times for sweep-to-sweep averaging in integers from 1 to 999.

If you click the **Sweep Average Restart** button while performing sweep-to-sweep averaging,  $n$  in Equation 3-1 will be reset to 1.

---

### Averaging by Each Measurement Point (Point Averaging)

With point averaging, each measurement point is measured the number of times designated by the user, and the average measured vector quantity sets the value for that point. Accordingly, sweep time becomes longer in proportion to an increased number of times set for averaging. Point averaging is performed according to Equation 3-2.

Equation 3-2 Point Averaging Calculation Formula

$$M = \frac{1}{F} \sum_{n=1}^F S_n$$

where;

- M = Calculation result of point averaging at the measurement point (vector quantity).
- S<sub>n</sub> = Measurement value from n-times sweeping at the measurement point (vector quantity).
- F = Point averaging n-times.

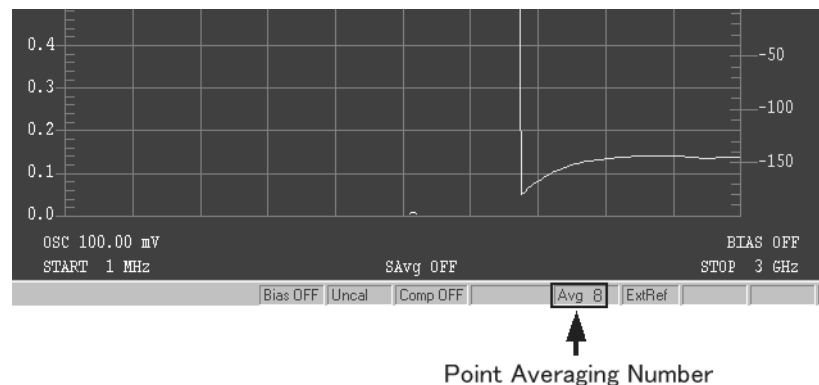
Set point averaging by following the procedure below.

#### Procedure

- Step 1.** Right-click to open the shortcut menu and click **Sweep Setup** (or press **[Sweep]**)
- Step 2.** Enter the number of times for point averaging with the numeric entry dialog box that appears by right-clicking inside the **Point Avg** box or with the **ENTRY/NAVIGATION** block keys on the front panel.

For example, to set the point averaging number of times to 8, click **8** and **Enter** in the numeric entry dialog box (or press **[8]** **[Enter]** using the **ENTRY/NAVIGATION** block keys on the front panel).

Figure 3-11 Displaying Point Averaging Number



**NOTE** You may set the number of times for point averaging in integers from 1 to 100.

Setting Measurement Conditions  
**Averaging Measurement Results**



---

**4****Calibration and Compensation**

It is necessary to perform calibration and compensation before using the Agilent E4991A to take measurements.

## Outline of Calibration and Compensation Functions

Any measuring instrument, however sophisticated it may be, has a certain degree of error in actual use. The functions of calibration and compensation of the E4991A minimize possible errors and assure higher measurement accuracy.

### Types of Calibration and Compensation

The E4991A has five calibration/compensation functions as shown in Table 4-1.

**Table 4-1 Calibration/Compensation Functions of E4991A**

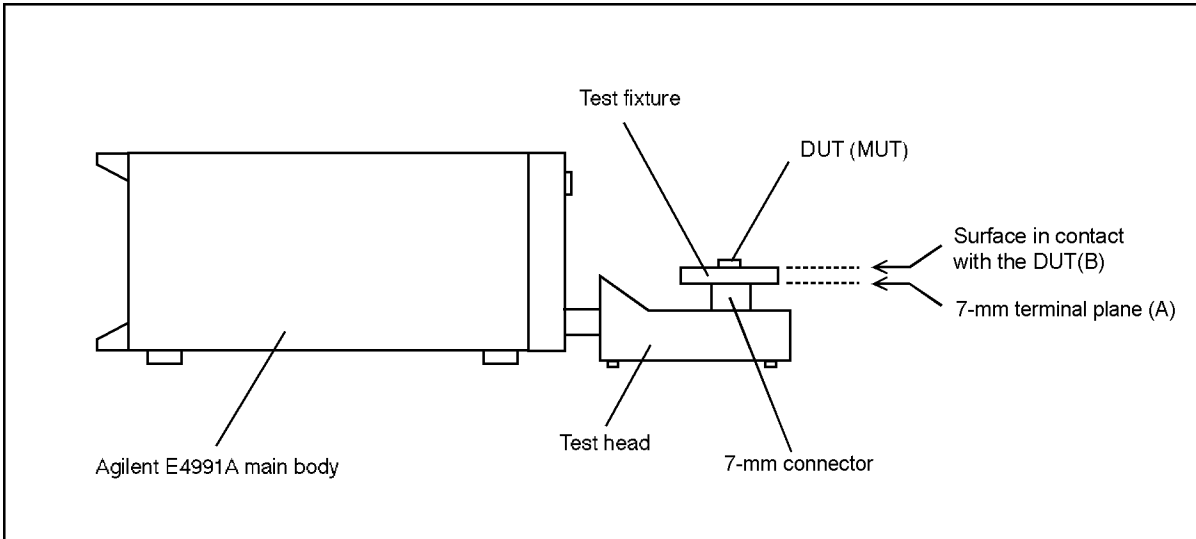
Calibration/compensation functions	Execution Method	Effect
Calibration of open/short/load	All calibration data are measured by connecting three standards (open, short, and load) one-by-one to the desired reference plane (connector). This reference plane is called the calibration reference plane.	The error factors within the area from the instrument body to the calibration reference plane are removed. If calibration is performed for the connector of the DUT, it is not necessary to execute any further calibration/compensation.
Calibration of low-loss capacitor	The calibration data are measured by connecting the low-loss capacitor to the calibration reference plane after completing the open/short/load calibration. This can only be executed when the 7-mm connector is used as the calibration reference plane.	This decreases high Q (low-loss coefficient) above the frequency band near 1 GHz, which is difficult to decrease by only using open/short/load calibration.
Port extension compensation <sup>*1</sup>	When the port is extended from the compensation reference plane by a coaxial cable, enter the delay time (sec.) of the extension as a numerical value and regard the corresponding extended portion as a distributed parameter circuit without loss.	This compensates additional error caused by phase shift in the area of the port extended by the coaxial cable.
Fixture electrical length compensation	Electrical length is entered as a numerical value. Since the electrical length of an exclusive-use test fixture is registered in the E4991A, the necessary electrical length can be set by simply selecting the model number of the test fixture used.	This compensates additional errors caused by phase shift at the test fixture.
Compensation of open/short	All compensation data are measured after bringing the tested device's connecting terminal to the open and/or short state.	This removes any additional measurement error caused by residual impedance in the test fixture.

\*1. Port extension compensation is not required when an Agilent test fixture is directly connected to the 7-mm terminal of the test head.

### Calibration Reference Plane and Calibration Standard

Before choosing which method of calibration and compensation to use, you must first decide where to set the calibration reference plane. The most common calibration reference plane is the 7-mm terminal plane in front of the test head. In this case, you may use open, short, load, and low-loss capacitor standards included in the calibration kit supplied with the E4991A. You may also use the terminal plane as a calibration reference plane for connecting the tested device. However, you need to use a calibration standard (working standard) that has a similar shape to the device under test.

**Figure 4-1** Calibration Reference Plane



e4991a0e120

**Table 4-2 Calibration Reference Plane and Necessary Calibration/Compensation**

Calibration Reference Plane	Necessary Calibration/Compensation	Place and Method of Execution
7-mm terminal for test head* <sup>1</sup> (A)	1. Calibration for open/short/load	Connect the coaxial terminal calibration kit to the coaxial terminal of the test head (calibration reference plane).
	2. Calibration of low-loss capacitor (This calibration is only used for such cases as high-Q measurement when high accuracy or consideration of low-loss factor is required at a frequency above approx. 1 GHz.)	Connect the low-loss capacitor to the calibration reference plane.* <sup>2</sup>
	3. Compensation for a fixture's electrical length	Enter this electrical length into the Agilent E4991A as data covering the area from the calibration reference plane to the tested device connecting plane.* <sup>3</sup>
	4. Compensation of open/short	Bring the tested device's connecting terminal into the open and short states.
Terminal for connecting to the DUT (B)	Calibration of open/short/load	Connect the working standard* <sup>4</sup> to the tested device's connecting terminal to make a calibration reference plane.

\*1. In extending the coaxial cable from the 7-mm terminal of test head to the test fixture, it is possible to compensate the port extension for the extended portion. For more on the port extension, see "Port Extension Compensation" on page 86.

\*2. Since the low-loss capacitor is the 7-mm type, this calibration can only be executed when the calibration reference plane is a 7-mm terminal.

\*3. When using an exclusive-use test fixture with a registered electrical length, you only need to select the model number of the fixture.

\*4. This is a reference device that has a similar shape to the device under test.

### Calibration/Compensation measurement point mode

The E4991A has three modes for defining the measurement points when the calibration and compensation data are measured.

#### User-defined frequency/User-defined power point mode

Obtain calibration/compensation data at the same frequency and power points as used in actual device measurement, which are determined by the sweep setups. Each set of calibration/compensation data is applied to each measurement at the same points.

#### Fixed frequency/fixed power point mode

Obtain calibration/compensation data in a fixed frequency (Table 4-4) and power (Table 4-5) range of the E4991A. In device measurement, calibration or compensation is applied to each measurement point by using interpolation.

#### Fixed frequency/user-defined power point mode

Obtain calibration/compensation data at fixed frequency points (Table 4-4) covering the entire frequency range of the E4991A and at the same power points used in actual device

measurement, which are determined by the sweep setups. Frequency interpolation is used to apply calibration or compensation to the device measurement.

**Table 4-3 Calibration/Compensation Measurement Point Mode**

Calibration/Compensation Measurement Point Mode	Calibration/Compensation Measurement Condition			Advantages	Disadvantages
	Frequency	Power	Number of measurement points		
User-defined frequency / User-defined power point mode ( <b>User Freq&amp;Pwr</b> )	Frequency points determined by sweep setups	Power points determined by sweep setups	Same as the number of sweep measurement points (NOP)	The most accurate DUT measurement can be performed.	Need to retake the calibration/compensation data if measurement points (frequency and/or power) are changed.
Fixed frequency / Fixed power point mode ( <b>Fixed Freq&amp;Pwr</b> )	372 Preset points (Table 4-4)	372 Preset points (Table 4-5)	$372 \times 3 = 1116$ points	Not necessary to retake the calibration/compensation data even if the measurement points are changed.	Takes longer time to complete calibration/compensation data measurement due to large number of measurement points.
Fixed frequency / User-defined power point mode* <sup>1</sup> ( <b>FixedFreq, UserPwr</b> )	372 Preset points (Table 4-4)	Power points determined by sweep setups	372 points	Not necessary to retake the calibration/compensation data if the frequency points are changed.	

\*1. This mode can be selected only when the sweep parameter is set to frequency.

Table 4-4

**Fixed Frequency Points for Calibration/Compensation Data Measurement (total 372 points)**

1.00 MHz, 1.03 MHz, 1.06 MHz, 1.09 MHz, 1.12 MHz, 1.15 MHz, 1.18 MHz, 1.21 MHz, 1.24 MHz, 1.26 MHz, 1.29 MHz, 1.32 MHz, 1.35 MHz, 1.38 MHz, 1.41 MHz, 1.44 MHz, 1.47 MHz, 1.50 MHz, 1.55 MHz, 1.60 MHz, 1.65 MHz, 1.70 MHz, 1.75 MHz, 1.80 MHz, 1.85 MHz, 1.90 MHz, 1.95 MHz, 2.00 MHz, 2.10 MHz, 2.20 MHz, 2.30 MHz, 2.40 MHz, 2.50 MHz, 2.60 MHz, 2.80 MHz, 3.00 MHz, 3.20 MHz, 3.40 MHz, 3.60 MHz, 3.80 MHz, 4.00 MHz, 4.30 MHz, 4.60 MHz, 5.00 MHz, 5.50 MHz, 6.00 MHz, 6.50 MHz, 7.00 MHz, 7.50 MHz, 8.00 MHz, 9.00 MHz,
10.0 MHz, 11.0 MHz, 12.0 MHz, 13.0 MHz, 14.0 MHz, 15.0 MHz, 16.0 MHz, 18.0 MHz, 20.0 MHz, 22.0 MHz, 24.0 MHz, 26.0 MHz, 28.0 MHz, 30.0 MHz, 33.0 MHz, 36.0 MHz, 39.0 MHz, 42.0 MHz, 45.0 MHz, 48.0 MHz, 51.0 MHz, 55.0 MHz, 60.0 MHz, 65.0 MHz, 70.0 MHz, 75.0 MHz, 80.0 MHz, 85.0 MHz, 90.0 MHz, 95.0 MHz,
100 MHz, 110 MHz, 120 MHz, 130 MHz, 140 MHz, 150 MHz, 160 MHz, 170 MHz, 180 MHz, 190 MHz, 200 MHz, 210 MHz, 220 MHz, 230 MHz, 240 MHz, 250 MHz, 260 MHz, 270 MHz, 280 MHz, 290 MHz, 300 MHz, 310 MHz, 320 MHz, 330 MHz, 340 MHz, 350 MHz, 360 MHz, 370 MHz, 380 MHz, 390 MHz, 400 MHz, 410 MHz, 420 MHz, 430 MHz, 440 MHz, 450 MHz, 460 MHz, 470 MHz, 480 MHz, 490 MHz, 500 MHz, 510 MHz, 520 MHz, 530 MHz, 540 MHz, 550 MHz, 560 MHz, 570 MHz, 580 MHz, 590 MHz, 600 MHz, 610 MHz, 620 MHz, 630 MHz, 640 MHz, 650 MHz, 660 MHz, 670 MHz, 680 MHz, 690 MHz, 700 MHz, 710 MHz, 720 MHz, 730 MHz, 740 MHz, 750 MHz, 760 MHz, 770 MHz, 780 MHz, 790 MHz, 800 MHz, 810 MHz, 820 MHz, 830 MHz, 840 MHz, 850 MHz, 860 MHz, 870 MHz, 880 MHz, 890 MHz, 900 MHz, 910 MHz, 920 MHz, 930 MHz, 940 MHz, 950 MHz, 960 MHz, 970 MHz, 980 MHz, 990 MHz,
1.00 GHz, 1.01 GHz, 1.02 GHz, 1.03 GHz, 1.04 GHz, 1.05 GHz, 1.06 GHz, 1.07 GHz, 1.08 GHz, 1.09 GHz, 1.10 GHz, 1.11 GHz, 1.12 GHz, 1.13 GHz, 1.14 GHz, 1.15 GHz, 1.16 GHz, 1.17 GHz, 1.18 GHz, 1.19 GHz, 1.20 GHz, 1.21 GHz, 1.22 GHz, 1.23 GHz, 1.24 GHz, 1.25 GHz, 1.26 GHz, 1.27 GHz, 1.28 GHz, 1.29 GHz, 1.30 GHz, 1.31 GHz, 1.32 GHz, 1.33 GHz, 1.34 GHz, 1.35 GHz, 1.36 GHz, 1.37 GHz, 1.38 GHz, 1.39 GHz, 1.40 GHz, 1.41 GHz, 1.42 GHz, 1.43 GHz, 1.44 GHz, 1.45 GHz, 1.46 GHz, 1.47 GHz, 1.48 GHz, 1.49 GHz, 1.50 GHz, 1.51 GHz, 1.52 GHz, 1.53 GHz, 1.54 GHz, 1.55 GHz, 1.56 GHz, 1.57 GHz, 1.58 GHz, 1.59 GHz, 1.60 GHz, 1.61 GHz, 1.62 GHz, 1.63 GHz, 1.64 GHz, 1.65 GHz, 1.66 GHz, 1.67 GHz, 1.68 GHz, 1.69 GHz, 1.70 GHz, 1.71 GHz, 1.72 GHz, 1.73 GHz, 1.74 GHz, 1.75 GHz, 1.76 GHz, 1.77 GHz, 1.78 GHz, 1.79 GHz, 1.80 GHz, 1.81 GHz, 1.82 GHz, 1.83 GHz, 1.84 GHz, 1.85 GHz, 1.86 GHz, 1.87 GHz, 1.88 GHz, 1.89 GHz, 1.90 GHz, 1.91 GHz, 1.92 GHz, 1.93 GHz, 1.94 GHz, 1.95 GHz, 1.96 GHz, 1.97 GHz, 1.98 GHz, 1.99 GHz, 2.00 GHz, 2.01 GHz, 2.02 GHz, 2.03 GHz, 2.04 GHz, 2.05 GHz, 2.06 GHz, 2.07 GHz, 2.08 GHz, 2.09 GHz, 2.10 GHz, 2.11 GHz, 2.12 GHz, 2.13 GHz, 2.14 GHz, 2.15 GHz, 2.16 GHz, 2.17 GHz, 2.18 GHz, 2.19 GHz, 2.20 GHz, 2.21 GHz, 2.22 GHz, 2.23 GHz, 2.24 GHz, 2.25 GHz, 2.26 GHz, 2.27 GHz, 2.28 GHz, 2.29 GHz, 2.30 GHz, 2.31 GHz, 2.32 GHz, 2.33 GHz, 2.34 GHz, 2.35 GHz, 2.36 GHz, 2.37 GHz, 2.38 GHz, 2.39 GHz, 2.40 GHz, 2.41 GHz, 2.42 GHz, 2.43 GHz, 2.44 GHz, 2.45 GHz, 2.46 GHz, 2.47 GHz, 2.48 GHz, 2.49 GHz, 2.50 GHz, 2.51 GHz, 2.52 GHz, 2.53 GHz, 2.54 GHz, 2.55 GHz, 2.56 GHz, 2.57 GHz, 2.58 GHz, 2.59 GHz, 2.60 GHz, 2.61 GHz, 2.62 GHz, 2.63 GHz, 2.64 GHz, 2.65 GHz, 2.66 GHz, 2.67 GHz, 2.68 GHz, 2.69 GHz, 2.70 GHz, 2.71 GHz, 2.72 GHz, 2.73 GHz, 2.74 GHz, 2.75 GHz, 2.76 GHz, 2.77 GHz, 2.78 GHz, 2.79 GHz, 2.80 GHz, 2.81 GHz, 2.82 GHz, 2.83 GHz, 2.84 GHz, 2.85 GHz, 2.86 GHz, 2.87 GHz, 2.88 GHz, 2.89 GHz, 2.90 GHz, 2.91 GHz, 2.92 GHz, 2.93 GHz, 2.94 GHz, 2.95 GHz, 2.96 GHz, 2.97 GHz, 2.98 GHz, 2.99 GHz, 3.00 GHz

Table 4-5

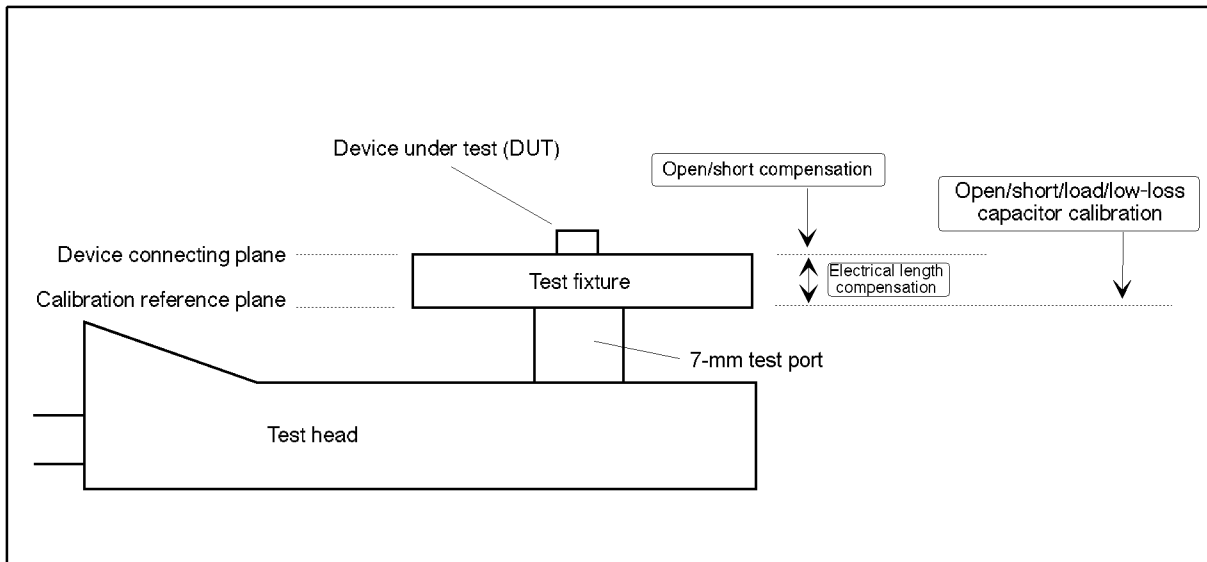
**Fixed Power Points for Calibration/Compensation Data Measurement (total 3 points)**

-23 dBm, -13 dBm, -3 dBm
--------------------------

## Calibration and Compensation Using 7-mm Test Port as a Calibration Reference Plane

In order to use the 7-mm test port as a calibration reference plane, the steps given in the procedure below need to be carried out in the order listed.

Figure 4-2 Calibration and Compensation using 7-mm Test Port as Calibration Reference Plane



e4991 aoe034

### Step 1. Definition of calibration/compensation

The definitions of the calibration kit and compensation kit to be used should be changed as needed.

For more on this procedure, see “Definition of Calibration/Compensation Kit” on page 91.

### Step 2. Open/short/load/low-loss capacitor calibration:

Measure calibration data of open/short/load with the 7-mm terminal of the test head. To measure a device with high Q (low-loss factor) at a frequency higher than approx. 1 GHz, calibration of low-loss capacitor needs to be done.

For more on this procedure, see “Calibration of Open/Short/Load/Low-loss Capacitor” on page 84.

### Step 3. Connection of test fixture

Connect the test fixture in front of the 7-mm terminal. For more on the connecting method, see the fixture’s operation manual.

### Step 4. Fixture’s electrical length compensation

The electrical length is set according to the kind of fixture used.

For more on this procedure, see “Electrical Length Compensation” on page 87.

**Step 5. Open/short compensation**

Measure the compensation data of open/short according to the test fixture used.

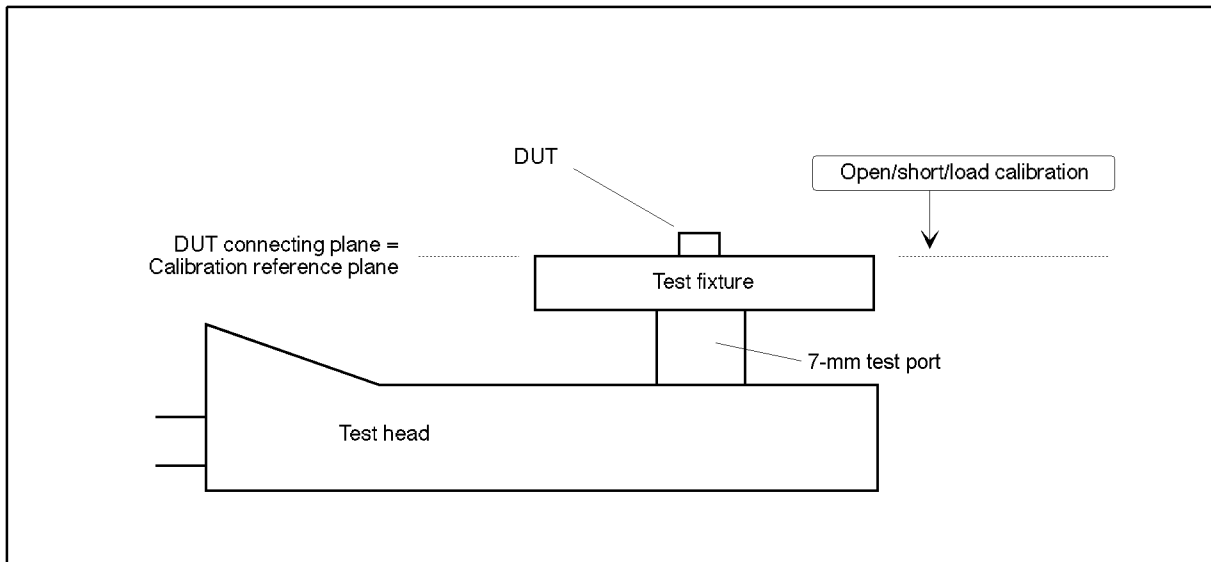
For more on this procedure, see “Fixture Compensation” on page 89.



## Calibration using DUT Connecting Terminal as a Calibration Reference Plane

To use the DUT connecting terminal as a calibration plane, you only need to execute calibration for open/short/load.

**Figure 4-3** Calibration using DUT Connecting Terminal as a Calibration Reference Plane



e4991aoe119

Measure the calibration data according to the following procedure:

### Step 1. Definition of calibration kit

The definition of the calibration kit used should be changed as needed.

For more on this procedure, see “Definition of Calibration/Compensation Kit” on page 91.

### Step 2. Connection of test fixture

Connect a test fixture in front of the 7-mm terminal. For more on the connecting method, see the fixture’s operation manual.

### Step 3. Open/short/load calibration

Measure the calibration data of open/short/load at the DUT connection terminal (used as a calibration reference plane).

For more on this procedure, see “Calibration of Open/Short/Load/Low-loss Capacitor” on page 84. (Note that low-loss capacitor calibration is not performed.)

---

## Calibration of Open/Short/Load/Low-loss Capacitor

The calibration data of open/short/load/low-loss capacitor is measured according to the following procedure.

### Step 1. Selection of measurement point for calibration/compensation

- a. Right-click to open the shortcut menu and click **Cal/Comp** (or press Cal/ Compen).
- b. Click the **Cal Menu** button.
- c. Click to open the **Cal Type** box and select the desired calibration/compensation measurement point mode.

Cal Type Box	Calibration/Compensation Measurement Point Mode
Fixed Freq&Pwr	Fixed frequency/fixed power point
FixedFreq, UserPwr	Fixed frequency/user-defined power point
User Freq&Pwr	User-defined frequency/user-defined power point

### Step 2. Measurement of open calibration data

- a. Connect the open standard (OS) to the terminal used as the calibration reference plane.

---

**NOTE**

When connecting a standard (open, short, load, low-loss capacitor) included in the E4991A calibration kit to the 7-mm terminal, firmly tighten it with the supplied torque wrench. If calibration data is measured when the standard is not adequately secured, this will degrade the repeatability of later measurements.

- b. Click the **Meas Open** button and measure the open calibration data.

---

**NOTE**

When you want to interrupt measurement of calibration data, click the **Abort Cal Meas** button shown during measurement.

When the measurement of each type of calibration data is finished, a check mark (✓) will appear to the left side of the corresponding calibration execution button. This mark indicates that the calibration data is stored.

### Step 3. Measurement of short calibration data.

- a. Connect the short standard (0 Ω) to the terminal used as the calibration reference plane.
- b. Click the **Meas Short** button and measure short calibration data.

### Step 4. Measurement of load calibration data.

- a. Connect the load standard (50 Ω) to the terminal used as the calibration reference plane.
- b. Click the **Meas Load** button and measure the load calibration data.

### Step 5. Measurement of low-loss capacitor calibration data.

If the 7-mm terminal is used as a calibration plane and low-loss capacitor calibration is required, execute the following procedure:

- a. Connect the low-loss capacitor to the 7-mm terminal used as the calibration reference plane.
- b. Click the **Meas Low-Loss C (optional)** button and measure the low-loss capacitor calibration data.

---

**NOTE**

Low-loss capacitor calibration can be performed only when the 7-mm terminal of the test head is used as the calibration reference plane.

---

**Step 6. Finishing calibration data measurement and confirmation of calibration state.**

- a. Click the **Done** button to finish measuring the calibration data.

---

**NOTE**

To delete all measured calibration data, click the **Cal Reset** button. At the same time, all stored fixture compensation data are also deleted.

- b. Confirm the calibration state according to the display of the **Cal Menu** button as shown below.

Display of Cal Menu button	Calibration State
Cal Menu [Fix]	Calibration is on while in the fixed frequency/fixed power point mode.
Cal Menu [FixR]	Calibration is on while in the fixed frequency/user-defined power point mode.
Cal Menu [User]	Calibration is on while in the user-defined frequency/user-defined power point mode.
Cal Menu [Uncal]	Calibration is off

## Port Extension Compensation

Port extension compensation is done to compensate the phase shift when the port is extended by a cable connected from the calibration reference plane (generally 7-mm terminal of test head). This function regards the transmission line as a distributed parameter circuit without loss.

Usually, port extension compensation is not necessary because the test fixture is connected directly to the front of 7-mm terminal of the test head.

### Procedure

- Step 1.** Right-click to open the shortcut menu and click the **Cal/Comp** button (or press  )
- Step 2.** By using the numeric entry dialog box that appears by right-clicking inside the **Port Extension** box (or using the **ENTRY/NAVIGATION** block keys on the front panel), enter the port extension compensation value (sec.) to be used.

## Electrical Length Compensation

The electrical lengths of the test fixtures shown in Table 4-6 have been registered in the E4991A in advance. To use these fixtures, you may set the needed electrical length by simply selecting the model number of the fixture to be used. If you use fixtures that are not registered, however, you must enter the electrical length as a numerical value.

**Table 4-6 Test fixtures with registered electrical lengths**

Model Number	Electrical Length
16191A	14 mm
16192A	11 mm
16193A	14 mm
16194A	50 mm
16196A	26.2 mm
16196B	26.9 mm
16196C	27.1 mm
16197A	14 mm
16453A	0 mm
16454A (Fixture size: S)	0 mm
16454A (Fixture size: L)	0 mm

**NOTE**

The 16453A is automatically selected when the permittivity measurement (**Permittivity**) is selected as material type (**Material Type**).

The 16454A (fixture size: S) or 16454A (fixture size: L) can be selected when the permeability measurement (**Permeability**) is selected as material type (**Material Type**).

For selecting the material type, refer to “Setting Material Measurement Parameter (Option 002 only)” on page 43.

## Procedure

### Step 1. Selecting fixture

- a. Right-click to open the shortcut menu and click **Cal/Comp** (or press Cal/ Compen).
- b. Click and open the **Fixture Type** box and then click to select the test fixture to be used. To use a test fixture that is not registered, select **User**.

Fixture Type box	Test Fixture
<b>None</b>	Electrical length compensation off
<b>16191A</b>	16191A
<b>16192A</b>	16192A
<b>16193A</b>	16193A
<b>16194A</b>	16194A
<b>16196A</b>	16196A
<b>16196B</b>	16196B
<b>16196C</b>	16196C
<b>16197A</b>	16197A
<b>16453A</b>	16453A
<b>16454A (S)</b>	16454A (fixture size: Small)
<b>16454A (L)</b>	16454A (fixture size: Large)
<b>User</b>	Test fixture not registered (user fixture)

### Step 2. Setting electrical length of user fixture

If **User** is selected in step 1-b, enter the electrical length of the fixture to be used by using the numeric entry dialog box that appears by right-clicking inside the **Fixture Length** box (or using the **ENTRY/NAVIGATION** block keys on the front panel).

## Fixture Compensation

Fixture compensation is executed according to the following procedure.

**NOTE**

Fixture compensation should always be done after open/short/load calibration, port extension compensation, or electrical length compensation.

### Measuring Fixture Compensation Data

**Step 1.** Right-click to open the shortcut menu and click the **Cal/Comp** button (or press **Cal/Compen**).

**Step 2.** Click the **Comp Menu** button.

**Step 3. Measurement of open compensation data**

Open compensation is executed according to the following procedure (if you do not need to execute this procedure, proceed to step 4).

- a. Bring the DUT measurement terminal of the test fixture to the open state. For how to bring it to the open state, see the manual of the test fixture used.
- b. Click the **Meas Open** button and measure the open compensation data.

**NOTE**

To stop measurement of fixture compensation data, click the **Abort Comp Meas** button that appears during compensation data measurement.

When the measurement of each type of calibration data is finished, a check mark (√) will appear to the left side of the corresponding calibration execution button. This mark indicates that the calibration data is stored.

**Step 4. Measurement of short compensation data**

Short compensation is executed according to the following procedure (if you do not need to execute this procedure, proceed to step 5).

- a. Bring the DUT measurement terminal of the test fixture to the short state. For how to bring it to the short state, see the manual of the test fixture used.
- b. Click the **Meas Short** button and measure the short compensation data.

**Step 5. Finishing compensation data measurement and confirmation of compensation state.**

Click the **Done** button to finish measuring the compensation data.

With this click, fixture compensation automatically turns on (error compensation is executed with compensation data for the measurement).

Fixture Comp Menu Button Display	Fixture Compensation State
Comp Menu: [ON]	On (error compensation is executed with compensation data for the measurement)
Comp Menu: [OFF]	Off (error compensation is not executed)

## Calibration and Compensation

### Fixture Compensation

---

**NOTE**

If you want to turn off the compensation data after they are measured and stored, turn off each fixture compensation individually according to “Switching Fixture Compensation On/Off” on page 90.

---

### Switching Fixture Compensation On/Off

After measurement of fixture compensation data, you may switch On/Off the stored open compensation data and short compensation data.

**Step 1.** Right-click to open the shortcut menu and click **Cal/Comp** (or press ).

**Step 2.** Click the **Comp Menu** button.

**Step 3.** Click the **Comp Open** button and **Comp Short** button to toggle their states On/Off.

Display of Comp Open Button	State of Open Compensation
<b>Comp Open: [On]</b>	On (open compensation is executed for the measurement)
<b>Comp Open: [Off]</b>	Off (open compensation is not executed for the measurement)

Display of Comp Short Button	State of Short Compensation
<b>Comp Short: [On]</b>	On (short compensation is executed for the measurement)
<b>Comp Short: [Off]</b>	Off (short compensation is not executed for the measurement)

---

**NOTE**

When either open compensation or short compensation should be on, the **Comp Menu** button is displayed as “On” (see step 5, Note in “Measuring Fixture Compensation Data” on page 89).

If you click the **Done** button, all stored compensation data will be automatically turned on.

---

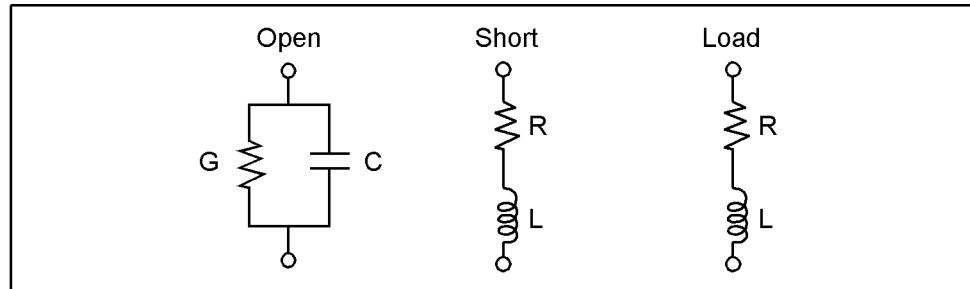


## Definition of Calibration/Compensation Kit

### Definition of Calibration Kit

Figure 4-4 shows a circuit model of the calibration kit supplied with the E4991A.

**Figure 4-4**      **Circuit Model of Calibration Kit.**



e4991a0j117

**NOTE**      To define the calibration kit for permittivity measurement, refer to “Definition of Calibration Kit in Permittivity Measurement” on page 92.

#### Procedure

- Step 1.** Right-click to open the shortcut menu and click the **Cal/Comp** button (or press ).
- Step 2.** Click the **Cal Kit Menu** button
- Step 3.** Click and open the **Cal Kit Type** box and click to select **User**.

Cal Kit Type Box	Types of Calibration Kits
<b>7 mm</b>	7-mm calibration kit (calibration kit supplied with the E4991A)
<b>User</b>	User calibration kit (a calibration kit prepared by the user)

**NOTE**      If you select **7 mm**, the definition prepared in advance is automatically applied (you cannot change the definition). If you use the 7-mm calibration kit supplied with the E4991A, please select **7 mm**.

- Step 4.** By using the numeric entry dialog box that appears by right-clicking inside the calibration kit definition box (or using the **ENTRY/NAVIGATION** block keys on the front panel),

## Calibration and Compensation

### Definition of Calibration/Compensation Kit

enter the definition of the calibration kit:

Calibration Kit Definition Box	Value to be defined
<b>Open G: (S)</b>	Equivalent parallel conductance G of Open calibration standard (preset state: 0 S)
<b>Open C: (F)</b>	Equivalent parallel capacitance C of Open Calibration standard (preset state: 82 fF)
<b>Short R: (<math>\Omega</math>)</b>	Equivalent series resistance R of Short Calibration standard (preset state: 0 $\Omega$ )
<b>Short L: (H)</b>	Equivalent series inductance L of Short Calibration standard (preset state: 0 H)
<b>Load R: (<math>\Omega</math>)</b>	Equivalent series resistance R of Load Calibration standard (preset state: 50 $\Omega$ )
<b>Load L: (H)</b>	Equivalent series inductance L of Load Calibration standard (preset state: 0 H)

### Definition of Calibration Kit in Permittivity Measurement

When the permittivity measurement (**Permittivity**) is selected as the material measurement type (**Material Type**) in “Setting Material Measurement Parameter (Option 002 only)” on page 43, the definition of the calibration kit is different from impedance measurement.

#### Procedure

**Step 1.** Right-click to open the shortcut menu and click the **Cal/Comp** button (or press **Cal/Compen**).

**Step 2.** Click the **Cal Kit Menu** button.

When the permittivity measurement is selected, **PTFE** is selected as the load standard of the calibration kit in the **Cal Kit Type** box.

**Step 3.** By using the numeric entry dialog box that appears by right-clicking inside the calibration kit definition box (or using the **ENTRY/NAVIGATION** block keys on the front panel), enter the definition of the compensation kit:

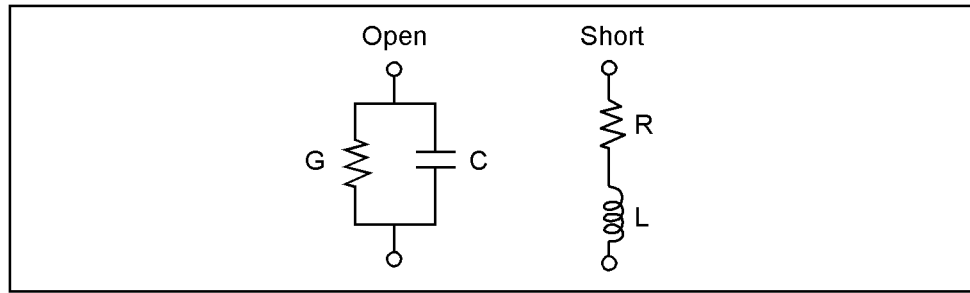
Load Calibration Standard Definition Box	Load Calibration Standard to be defined
<b><math>\epsilon_r</math> Real</b>	Real part of permittivity of the load calibration standard (preset state: 2.1)
<b><math>\epsilon_r</math> Loss</b>	Imaginary part of permittivity of the load calibration standard (preset state: 0)
<b>Thickness</b>	Thickness of the load calibration standard (preset state: 800 $\mu\text{m}$ )

### Definition of Compensation Kit

Figure 4-5 shows the circuit model of the compensation kit adopted in the E4991A.

**Figure 4-5**

**Circuit model of compensation kit**



e4991aoj118

**Procedure**

- Step 1.** Right-click to open the shortcut menu and click the **Cal/Comp** button (or press ).
- Step 2.** Click the **Comp Kit Menu** button.
- Step 3.** By using the numeric entry dialog box that appears by right-clicking inside the compensation kit definition box (or using the **ENTRY/NAVIGATION** block keys on the front panel), enter the definition of the compensation kit:

Calibration Kit Definition Box	Value to be defined
<b>Open G: (S)</b>	Equivalent parallel conductance $G$ of Open compensation standard (preset state: 0 S)
<b>Open C: (F)</b>	Equivalent parallel capacitance $C$ of Open Compensation standard (preset state: 0 F)
<b>Short R: (<math>\Omega</math>)</b>	Equivalent series resistance $R$ of Short Compensation standard (preset state: 0 $\Omega$ )
<b>Short L: (H)</b>	Equivalent series inductance $L$ of Short Compensation standard (preset state: 0 H)

## **Restoring Calibration/Compensation Status**

The E4991A has a function to restore the previously set calibration/compensation status (including calibration/compensation data) in the event that it becomes invalid due to erroneous entry after calibration/compensation measurement. The restored data arrays include calibration data arrays, calibration coefficient arrays, fixture compensation data arrays, and fixture compensation coefficient arrays (Figure 7-1 on page 168). For more information on restoring settings, refer to “Initial Settings, Settings that can be Saved/Recalled, Settings that can be Backed Up” on page 440.

### **Procedure**

- Step 1.** Right-click to open the shortcut menu and then click **Cal/Comp** (or press ).
- Step 2.** Click the **Recover Cal/Comp State** button.

---

### **NOTE**

After turning off the power, the calibration/compensation data become permanently lost and thus cannot be recovered. You can only restore calibration/compensation data that have been acquired since turning the power on.

---

---

## **5** **Display Setting**

This chapter describes the various ways of displaying the measurement results of the Agilent E4991A RF Impedance/Material Analyzer.

---

## Setting the Types and Numbers of Display Traces

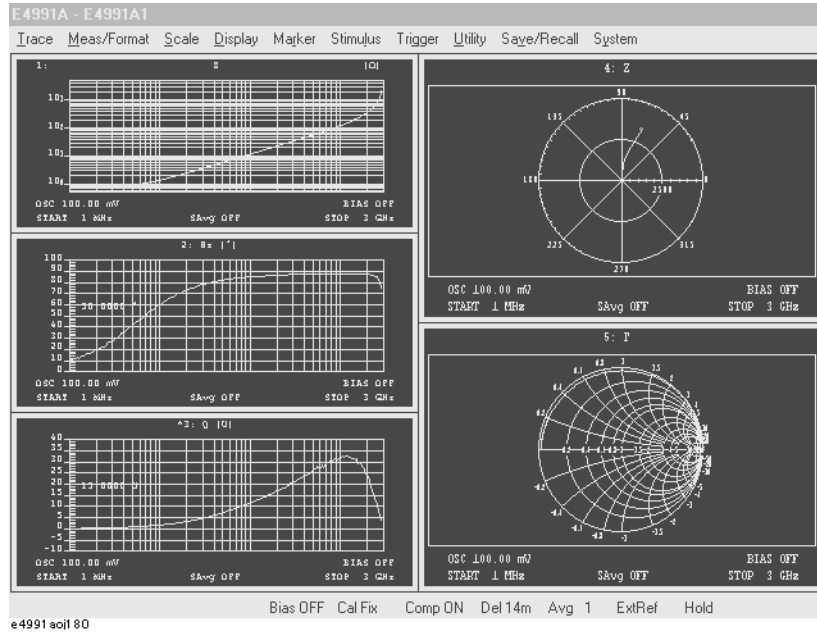
The E4991A is able to simultaneously display a maximum of five traces: three scalar traces and two complex.

### Procedure

- Step 1.** Right-click to open the shortcut menu and select **Display** (or press the **Display** key on the front panel).
- Step 2.** Click to open the **Number of Traces** drop-down box and select the desired types and numbers of traces to display.

Number of Traces Box	Types and Numbers of Displayed Traces
<b>1 Scalar</b>	Scalar trace × 1
<b>2 Scalar</b>	Scalar trace × 2
<b>3 Scalar</b>	Scalar trace × 3
<b>1 Complex</b>	Complex traces × 1
<b>2 Complex</b>	Complex traces × 2
<b>1 Sclr, 1 Cmplx</b>	Scalar trace × 1 Complex traces × 1
<b>1 Sclr, 2 Cmplx</b>	Scalar trace × 1 Complex traces × 2
<b>2 Sclr, 1 Cmplx</b>	Scalar trace × 2 Complex traces × 1
<b>2 Sclr, 2 Cmplx</b>	Scalar trace × 2 Complex traces × 2
<b>3 Sclr, 1 Cmplx</b>	Scalar trace × 3 Complex traces × 1
<b>3 Sclr, 2 Cmplx</b>	Scalar trace × 3 Complex traces × 2

**Figure 5-1** Display of 3 Scalar Traces / 2 Complex Traces (3 Sclr, 2 Cmplx)



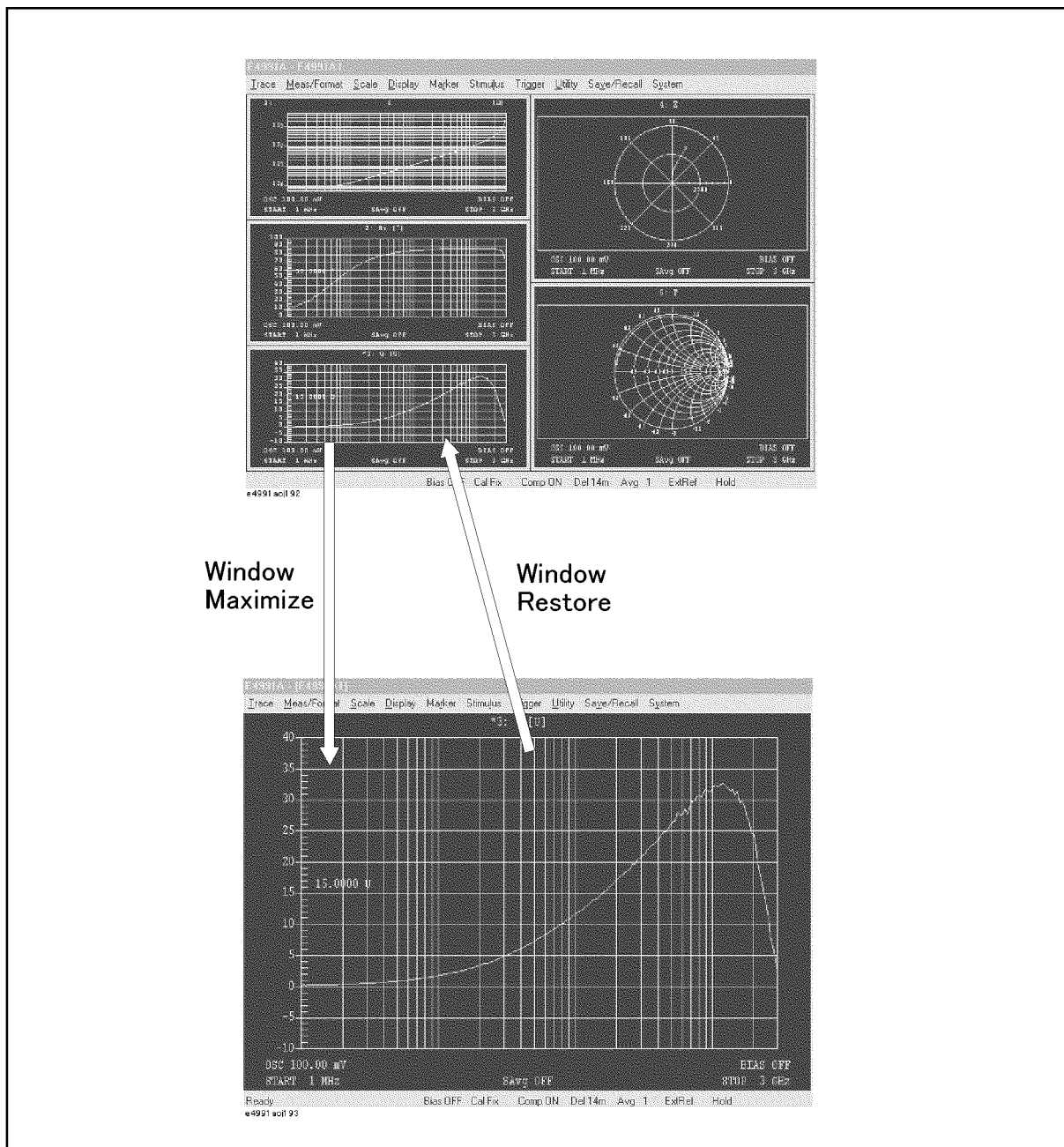
**NOTE**

In Figure 5-1, scalar traces are displayed in the split display mode. For details about overlay and split displays, refer to “Overlay Display and Split Display of Graphs” on page 114.

## Maximize a Display Window on the Screen

When multiple windows are displayed on the screen after selecting the number of traces to display, the window that contains the active trace can be maximized on the screen (Figure 5-2).

Figure 5-2 Maximize and Restore a Display Window



e4991a0j196



### Procedure

- Step 1.** Click inside the window you want to maximize (or press **Trace**) to make the window active. The frame of the selected window becomes red.
- Step 2.** Right-click to open the shortcut menu and then select **Display** (or press **Display**).
- Step 3.** Click **More** (or press **Display**).
- Step 4.** Click **Window Maximize** to maximize the window.

To go back to the original window size and configuration of windows showing all traces, click **Window Restore**

## Selecting Measurement Parameter (Impedance Measurement)

The measurement parameter is selected with the **Meas Parameter** box in the **Meas/Format** toolbar (Table 5-1, Table 5-2).

**Table 5-1 Meas Parameter Box (for scalar traces)**

Meas Parameter Box	Measurement Parameter
Z	Impedance absolute value
$\theta_z$	Impedance phase
<b>R</b>	Resonance resistance
<b>X</b>	Equivalent series reactance
Y	Absolute value of admittance
$\theta_y$	Phase of admittance
<b>G</b>	Equivalent parallel conductance
<b>B</b>	Equivalent parallel susceptance
$\Gamma$	Reflection parameter
$\theta_\gamma$	Phase of reflection parameter
$\Gamma_x$	Real part of reflection coefficient (complex number)
$\Gamma_y$	Imaginary part of reflection coefficient (complex number)
<b>Cp</b>	Equivalent parallel capacitance
<b>Cs</b>	Equivalent series capacitance
<b>Lp</b>	Equivalent parallel inductance
<b>Ls</b>	Equivalent series inductance
<b>Rp</b>	Equivalent series resistance
<b>Rs</b>	Equivalent parallel resistance
<b>D</b>	Loss coefficient
<b>Q</b>	Q value

**Table 5-2 Meas Parameter Box (for complex traces)**

Meas Parameter Box	Measurement Parameter
<b>Z</b>	Complex impedance
<b>Y</b>	Complex admittance

**Table 5-2 Meas Parameter Box (for complex traces)**

Meas Parameter Box	Measurement Parameter
$\Gamma$	Complex reflection coefficient

**Procedure**

- Step 1.** Click inside the window of the trace whose measurement parameter you want to select (or click the measurement parameter name (area e.g. **2:  $\theta z$  [°]**) in an overlay display) (or press the **Trace** key on the front panel), thus making the trace active.
- Step 2.** Right-click to open the shortcut menu and select **Meas/Format** (or press the **Meas/Format** key on the front panel).
- Step 3.** Click on the **Meas Parameter** drop-down box and select the desired Meas Parameter (Table 5-2, Table 5-1).

**NOTE**

When using the E4991A with option 002 (material measurement function), it is possible to select dielectric material or magnetic material measurement parameters in addition to the measurement parameters listed above. See “Setting Measurement Parameter (Material Measurement)” on page 102.

## Setting Measurement Parameter (Material Measurement)

When using “Option 002 material measurement” with the E4991A for material measurement, select the parameters by following the procedure below.

### Procedure

- Step 1.** Click inside the window of the trace whose measurement parameter you want to select (or click the measurement parameter name (area e.g. **2:  $\epsilon_r''$  [MU]**) in an overlay display) (or press the **Trace** key on the front panel), thus making the trace active.
- Step 2.** Right-click to open the shortcut menu and select **Meas/Format** (or press **Meas/Format**).
- Step 3.** Click on the **Meas Parameter** drop-down box and select the desired measurement parameter. (In material measurement, parameters in Table 5-3 to Table 5-6 are added to the impedance measurement parameters).

Table 5-3

**Meas Parameter Box (for dielectric material/scalar traces)**

Meas Parameter:	Measurement Parameter
$\epsilon_r'$	Real part of complex permittivity ( $\epsilon_r'$ )
$\epsilon_r''$	Imaginary part of complex permittivity ( $\epsilon_r''$ )
$\tan\delta (\epsilon)$	Dielectric loss tangent ( $\tan\delta$ )
$ \epsilon_r $	Absolute value of complex permittivity ( $ \epsilon_r $ )

Table 5-4

**Meas Parameter Box (for dielectric material/complex traces)**

Meas Parameter:	Measurement Parameter
$\epsilon_r$	Complex permittivity ( $\epsilon_r$ )

Table 5-5

**Meas Parameter Box (for magnetic material/scalar trace)**

Meas Parameter:	Measurement Parameter
$\mu_r'$	Real part of complex permeability ( $\mu_r'$ )
$\mu_r''$	Imaginary part of complex permeability ( $\mu_r''$ ).
$\tan\delta (\mu)$	Magnetic loss tangent ( $\tan\delta$ )
$ \mu_r $	Absolute value of complex permeability ( $ \mu_r $ )

Table 5-6

**Meas Parameter Box (for Magnetic Material / Complex Trace)**

<b>Meas Parameter:</b>	<b>Measurement Parameter</b>
$\mu_r$	Complex permeability ( $\mu_r$ )

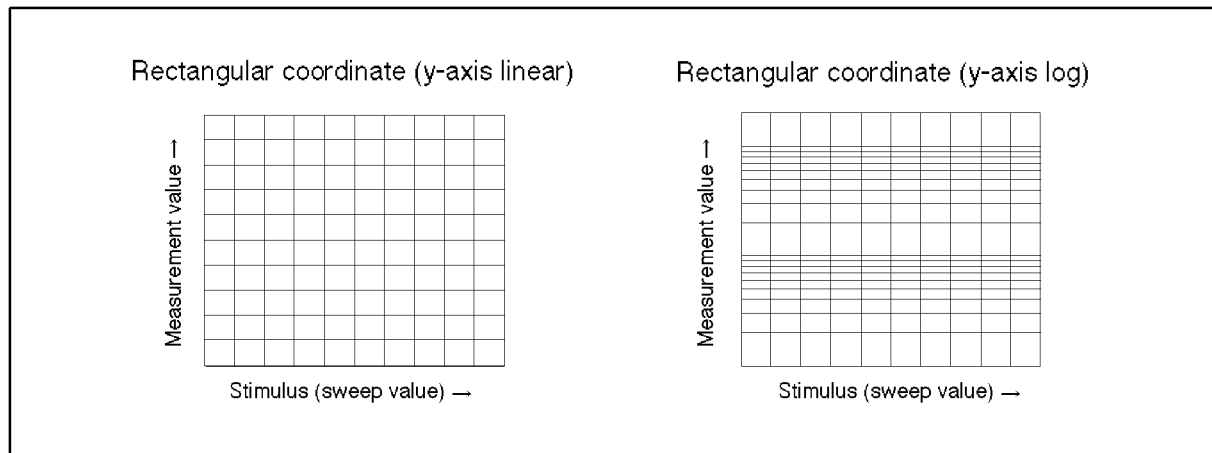
## Selecting Graph Coordinate Format

The Graph Coordinate Format differs according to the measurement parameter used (see Table 5-7, Figure 5-3, Figure 5-4).

**Table 5-7** Types of Measurement Parameters and Available Graph Coordinate Formats (√: Available)

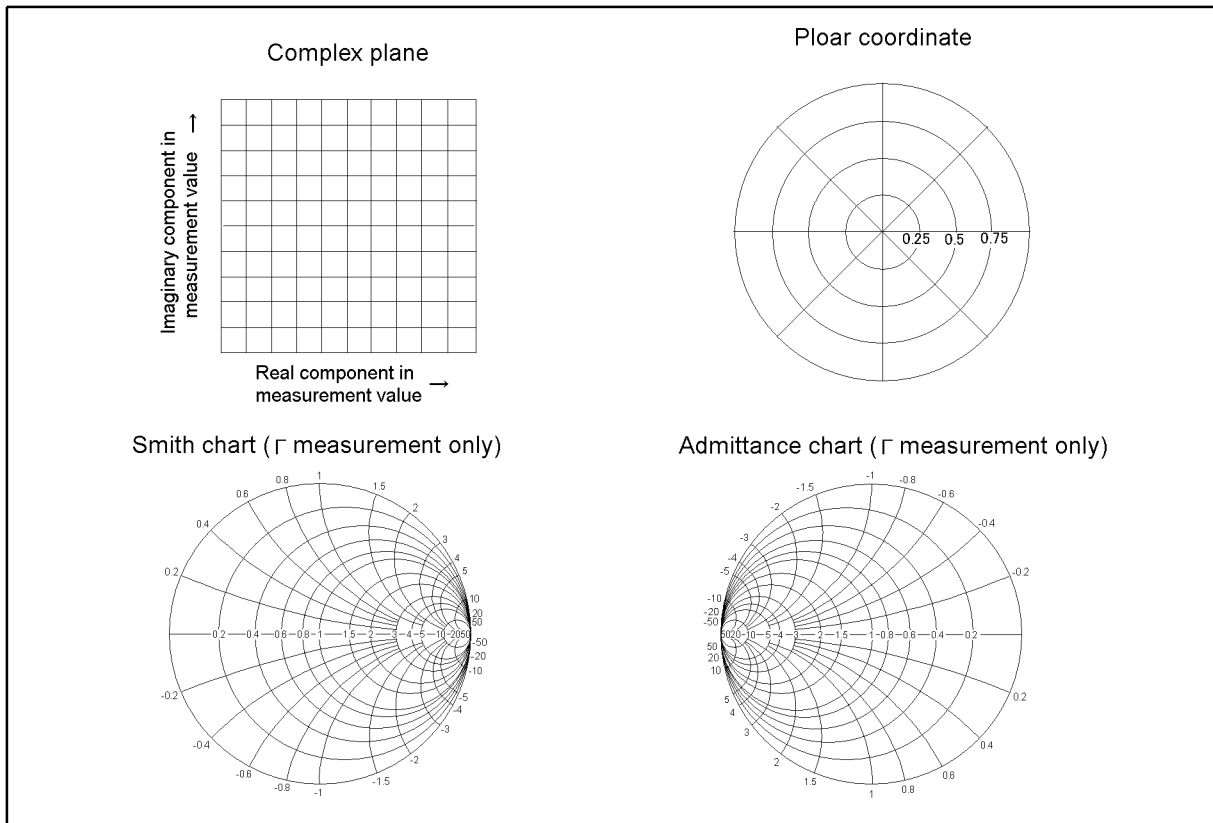
Measurement Parameter	Rectangular coordinate (y-axis linear)	Rectangular coordinate (y-axis log)	Complex plane	Polar coordinate	Smith chart	Admittance chart
Scalar parameter ( $ Z $ , $\theta_z$ , $L_s$ , etc.)	√	√				
Complex parameter	Z, Y		√	√		
	$\Gamma$		√	√	√	√

**Figure 5-3** Available Graph Coordinate Formats in Scalar Parameter Measurement



e4991a0e115

Figure 5-4 Optional Graph Coordinate Format in the Complex Parameter Measurement



e4991a0e116

### Procedure

- Step 1.** Click inside the window of the trace whose coordinate format you want to select (or click the measurement parameter name (area e.g. **2: θz [°]**) in an overlay display) (or press the **Trace** key on the front panel), thus making the trace active.
- Step 2.** Click and open the shortcut menu and select **Meas/Format** (or press the **Meas/Format** key).
- Step 3.** Click on the **Format** drop-down box and select the desired coordinate format.

Format Box (for scalar parameter measurement)	Coordinate Format
<b>Lin-Y-Axis</b>	Rectangular coordinates of Y-axis linear (X-axis: Sweep parameter, Y-axis: Measurement parameter)
<b>Log Y-Axis</b>	Rectangular coordinates of Y-axis log (X-axis: Sweep parameter, Y-axis: Measurement parameter)

## Display Setting

### Selecting Graph Coordinate Format

<b>Format Box (for complex parameter measurement)</b>	<b>Coordination Format</b>
<b>Complex</b>	Complex plane (X-axis: Actual number, Y-axis: imaginary number)
<b>Polar</b>	Polar coordinate
<b>Smith<sup>*1</sup></b>	Smith chart
<b>Admittance<sup>*1</sup></b>	Admittance chart

\*1. Selection is only possible when the measurement parameter is  $\Gamma$  (complex reflection parameter).



---

## Autoscale Adjustment

### Autoscale Adjustment for each Trace

#### Procedure

- Step 1.** Click inside the window of the trace whose autoscale adjustment you want to select (or click the measurement parameter name (area e.g. **2:  $\theta z$  [°]**) in an overlay display) (or press the **Trace** key on the front panel), thus making the trace active
- Step 2.** Right-click to open the shortcut menu and select **Scale** (or press the **Scale** key).
- Step 3.** Click the **Autoscale** button to execute Autoscale Adjustment.

### Autoscale Adjustment for all Traces at Once

#### Procedure

- Step 1.** Right-click to open the shortcut menu and select **Scale** (or press the **Scale** key).
- Step 2.** Click the **Autoscale All** button to execute Autoscale adjustment for all of the traces on the display.

## Manual Scale Setting

Scale setting differs according to the coordinate format of the target trace (Table 5-8, Figure 5-5).

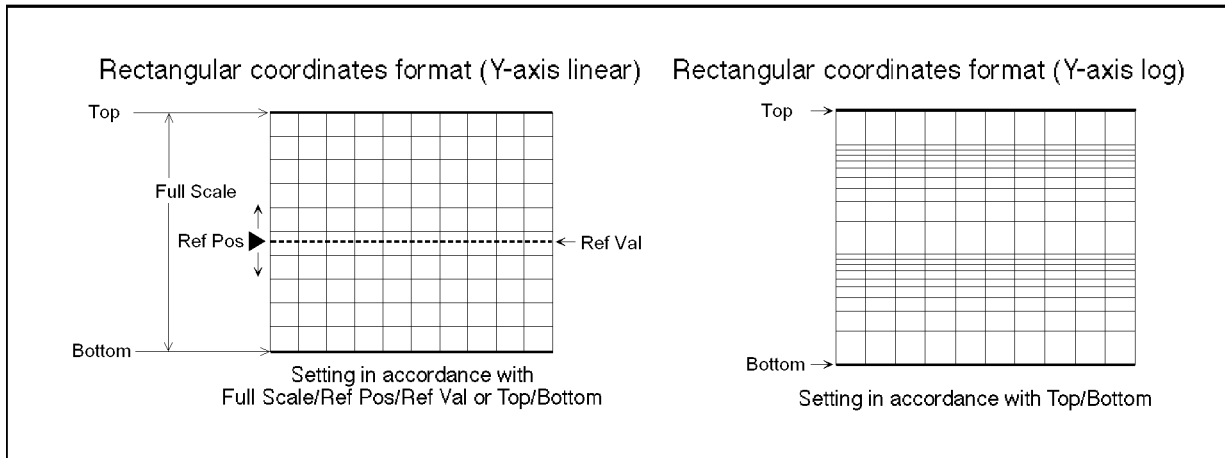
**Table 5-8 Method of setting scale for each coordination format**

Measurement parameter	Coordinate format to select	Method of manually setting scale
Scalar parameter ( $ Z $ , $\theta_z$ , $L_s$ , etc.)	Rectangular coordinates (Y-axis linear)	<ul style="list-style-type: none"> <li>Setting according to full-scale value (Full Scale), position of reference line (Ref Pos) and value of reference line (Ref Val).</li> <li>Setting according to max. value (Top) and min. value (Bottom).</li> </ul>
	Rectangular coordinates (Y-axis log)	Setting according to max. value (Top) and min. value (bottom)
Complex parameter ( $Z$ , $Y$ , $\Gamma$ )	Complex plane	Setting according to 1 scale length (Scale), X-axis reference line (Ref X) and Y-axis reference line has (Ref Y)
	Polar coordinate	Setting according to the distance (scale) from origin to the outer most circle
	Smith chart (only $\Gamma$ )	(not changeable, scale is always fixed)
	Admittance chart (only $\Gamma$ )	(not changeable, scale is always fixed)

### Scale Setting in Rectangular Coordinates

When the Y-axis is set to linear in the rectangular coordinate format, it is possible to set the scale according to the position of the reference line (Ref Pos), value of reference line (Ref Val) and full-scale value (Full Scale), or according to the max. value (Top) and min. value (Bottom). However, when the Y-axis is set to log in the rectangular coordinate format, it is only possible to set the scale according to the max. value (Top) and min. value (Bottom).

Figure 5-5 Scale setting according to the coordination format



e4991 a0e066

### Procedure

- Step 1.** Click inside the window of the trace whose scale setting you want to adjust (or click the measurement parameter name (area e.g. **2:  $\theta z$  [°]**) in an overlay display) (or press the **Trace** key on the front panel), thus making the trace inside the window active.
- Step 2.** Right-click to open the shortcut menu and select **Scale** (or press the **Scale** key).
- Step 3.** Click the **Scale Entry** Button and select the scale setting format.

Scale Entry Button Display	Scale setting format
Scale Entry [Scale/Ref]	Setting according to full-scale value, position of reference line, value for reference line.
Scale Entry [Top/Bottom]	Setting according to max. and min. values (max. and min. values can be changed by modifying the reference line position while keeping the corresponding full-scale value unchanged).

### NOTE

When the y-axis is log scale, you cannot select **Scale Entry [Scale/Ref]**.

- Step 4.** Using the numeric entry dialog box that appears by right-clicking inside each setting box below (or using the **ENTRY/NAVIGATION** block keys on the front panel), enter the value of each scale setting.

Scale Setting Box	Entry Value
Full Scale	Full-scale value
Ref Val	Value for Y-axis reference line
Ref Pos	Position of reference line with the linear scale showing 10 as max. value and 0 as min. value. The value of the middle point on the Y-axis is 5.
Top	Max. value (highest value on y-axis scale)

Display Setting  
**Manual Scale Setting**

**Scale Setting Box**

**Entry Value**

**Bottom**

Min. value (lowest value on y-axis scale)

---

**NOTE**

The display of the reference line and the value of the reference line on the graph can be switched On/Off with the **Reference Line** button.

Instead of entering the value of the reference line as a numerical value into the **Ref Val** box, you can directly enter the position of the marker (measurement value) into the reference line value. See “Setting of Reference Line Value by Using Marker” on page 112.

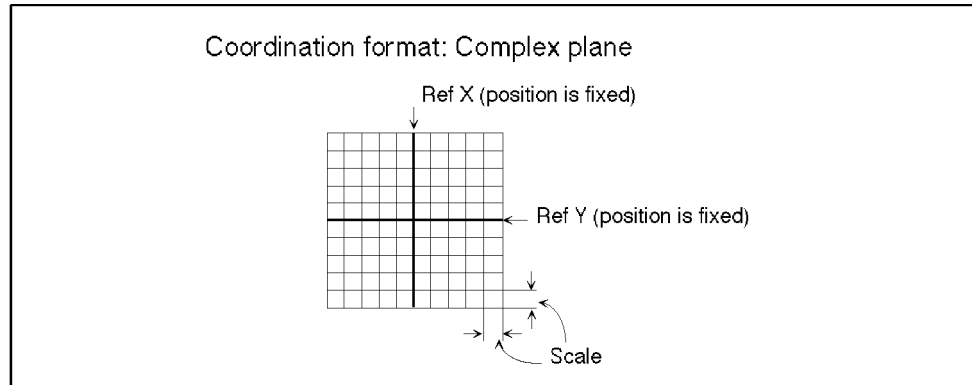
---

## Scale Setting on Complex Plane

When the coordinate format is the complex plane, the scale setting shall be made on the basis of the length per scale (Scale), X-axis reference value (Ref X), and Y-axis reference value (Ref Y).

Figure 5-6

Scale Setting in complex plane display



e4991aoe113

### Procedure

- Step 1.** Click inside the complex trace on which you want to set the Scale Setting (or press **Trace**) to make the trace active.
- Step 2.** Right-click to open the shortcut menu and select **Scale** (or press the **Scale** key).
- Step 3.** Using the numeric entry dialog box that appears by right-clicking inside each Scale Setting Box (or using the **ENTRY/NAVIGATION** block keys on the front panel), enter each value.

Scale Setting Box	Entry Value
<b>Scale</b>	The length per scale (common to X-axis and Y-axis).
<b>Ref X</b>	Value of X-axis reference line (middle point).
<b>Ref Y</b>	Value of Y-axis reference line (middle point).

### NOTE

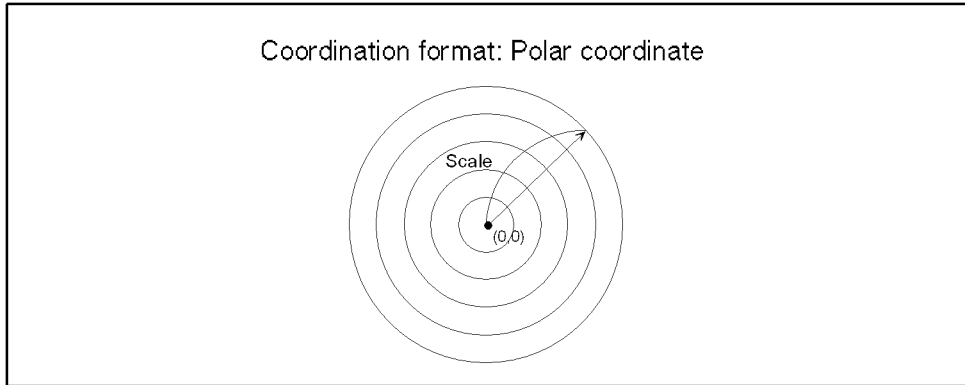
Instead of entering the value of the reference line as a numerical value into the **Ref X** box and **Ref Y** box, you can directly enter the actual number portion and imaginary number portion of the marker position's measurement value into the value of the X-axis reference line and the value of the Y-axis reference line. See "Setting of Reference Line Value by Using Marker" on page 112.

## Scale Setting in Polar Coordinate Format

When the coordinate format is polar, set the scale according to the distance (scale) from the origin to the outermost circle.

Figure 5-7

### Scale Setting in Polar Coordinate Format



e4991ace114

### Procedure

- Step 1.** Click inside the complex trace whose scale you want to set (or press the **Trace** key) to make the trace active.
- Step 2.** Right-click to open the shortcut menu and select **Scale** (or press the **Scale** key).
- Step 3.** Using the numeric entry dialog box that appears by right-clicking inside the **Scale** box (or using the **ENTRY/NAVIGATION** block keys on the front panel), enter the distance from the origin to the outermost circle.

## Setting of Reference Line Value by Using Marker

The reference line value can be set by using the position of marker when the coordinate format is rectangular (Y-axis linear) or a complex plane.

- Step 1.** Click inside the window of the trace whose scale you want to set (or click the measurement parameter name area (e.g. **2:  $\theta z$  [°]**) in overlay display) (or press the **Trace** key) to make the trace active.
- Step 2.** Move the marker to the position on the trace that you want to use as the value of the scale reference line and leave the marker active.
- Step 3.** Right-click to open the shortcut menu and select **Marker** (or press the **Marker** key).
- Step 4.** Click the **Marker To Menu** button.
- Step 5.** Press the **Reference** button and assign the measurement value of the active marker's position as the reference value.

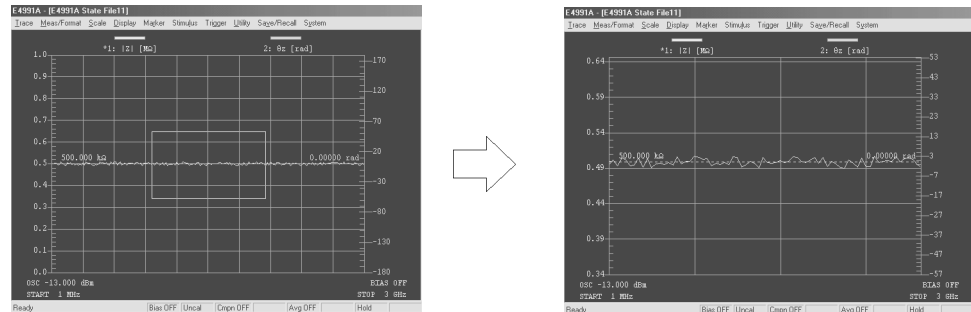
When the coordinate format is a complex plane, the actual number portion and imaginary number portion of the measurement value of the marker position can be assigned into the value of the X-axis reference line and the value of the Y-axis reference line.

## Zooming a Trace

By using the mouse, a specified area of the trace on the display can be zoomed.

Figure 5-8

### Zooming a Trace




### Procedure

- Step 1.** Imagine a rectangular area of the active trace that you would like to zoom and place the cursor at one corner (e.g. upper left) while holding down the left mouse button.
- Step 2.** Drag the cursor along the diagonal line of the imaginary rectangular area while holding down the mouse button.
- Step 3.** Release the left mouse button, when the cursor reaches to the opposite corner of the rectangle from where you started.

### NOTE

To return the zoomed trace to the original size, simply click the cursor once in the display.

It is not possible to continue zooming the trace more than once.

The trace cannot be zoomed if the specified rectangular area is too small. While dragging, the cursor remains a  icon until the specified area is large enough for zooming.

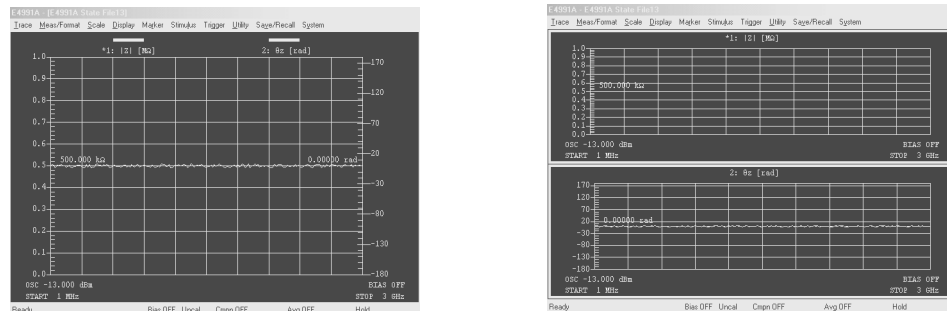
Zooming of the trace is only possible by using the mouse.

## Overlay Display and Split Display of Graphs

To display more than two scalar traces, you may select either the overlay display or the split display.

Figure 5-9

Overlay display (left) and split display (right) of graphs



### Procedure

- Step 1.** Right-click to open the shortcut menu and select **Display** (or press the **[Display]** key).
- Step 2.** Click the **Display Scalar Trace** button to toggle between **[Overlay]** and **[Split]**.

#### Display Scalar Trace Button

#### Overlay/Split Display

Display Scalar Trace **[Overlay]**

Overlay display

Display Scalar Trace **[Split]**

Split display

### NOTE

Complex traces are always viewed in split display and never in overlay display.

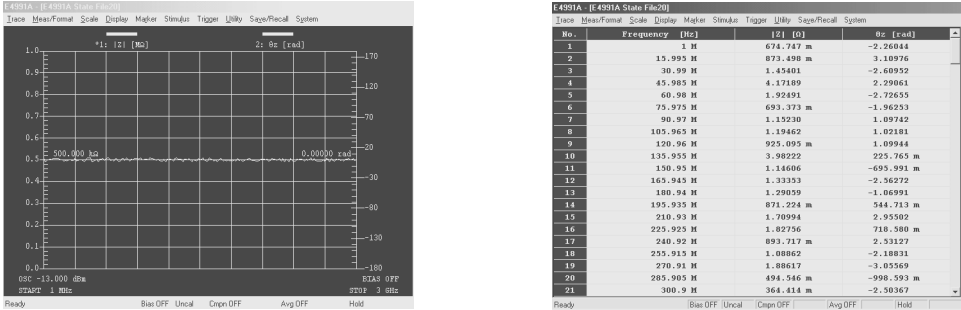


## Displaying Measurement Values in List Form

Instead of displaying the trace in graph form, the measured values can be displayed in a numerical list.

Figure 5-10

Displaying the measured values in list “Off” (left) and “On” (right)



### Procedure

- Step 1.** Right-click to open the shortcut menu and select **Display** (or press the **Display** key).
- Step 2.** Click the **List Values** button to toggle display of list values [On] and [Off]. If multiple traces are displayed, this button toggles the state of the active trace (outlined in red).

## Trace Comparison Using Memory Trace

### Comparison with a stored reference trace

#### Procedure

- Step 1.** Measure and display the reference trace.
- Step 2.** Click inside the window of the reference trace (or click the measurement parameter name area (e.g. **2:  $\theta z$  [°]**) in overlay display) (or press the **Trace** key) to make the trace active.
- Step 3.** Right-click to open the shortcut menu and select **Display** (or press the **Display** key).
- Step 4.** Click the **Copy Data** → **Memory** button to store the reference trace's data in the memory trace.

#### NOTE

When the **Copy Data** → **Memory** button is clicked, usually only the active trace's data are stored in the memory trace. However, if the active trace is one of different overlaid traces in the same window, the data of all traces in the window are stored in memory traces.

- Step 5.** Click on the **Define Trace** box and select the method of displaying the trace.

Define Trace Box	Trace Display Method
<b>Data</b>	Data Trace: <i>DATA</i> Memory Trace: (No display)
<b>Memory</b>	Data Trace: (No display) Memory Trace: <i>MEM</i>
<b>Data &amp; Memory</b>	Data Trace: <i>DATA</i> Memory Trace: <i>MEM</i>
<b>Data – Memory</b>	Data Trace: <i>DATA – MEM</i> Memory Trace: (No display)
<b>Delta %</b>	Data Trace: $\frac{DATA - MEM}{MEM} \times 100$ Memory Trace: (No display)

where *DATA* is the measurement data and *MEM* is the data stored by the **Copy Data** → **Memory** button.

### Subtraction of Offset Value

The result of subtracting an offset value from the measurement value can be displayed as a data trace.

#### Procedure

- Step 1.** Click inside the window of the trace from which the offset value will be subtracted (or

click the measurement parameter name area (e.g. **2:  $\theta z$  [°]**) in overlay display) (or press the **Trace** key) to make the trace active.

- Step 2.** Right-click to open the shortcut menu and select **Display** (or press the **Display** key).
- Step 3.** Using the numeric entry dialog box that appears by right-clicking inside the **Math Offset** box (or using the **ENTRY/NAVIGATION** block keys on the front panel), enter the Offset value.

### Offset Value Setting by Using the Marker

The measurement value of the marker's position can be directly assigned as the offset value.

- Step 1.** Click inside the window of the trace in which the offset value will be set (or click the measurement parameter name area (e.g. **2:  $\theta z$  [°]**) in overlay display) (or press the **Trace** key) to make the trace active.
- Step 2.** Move the marker to the position on the trace to be set as the offset value and leave the marker active.
- Step 3.** Right-click to open the shortcut menu and select **Marker** (or press the **Marker** key).
- Step 4.** Click the **Marker To Menu** button.
- Step 5.** Press the **Offset** button to assign the measurement value of the active marker's position as an offset value.

## Selecting Sweep Area Display (Start/Stop or Center/Span)

The sweep area shown at the bottom of the measurement display can be set to display either the sweep's start value and stop value or the sweep's center value and span value.

### Procedure

- Step 1.** Right-click to open the shortcut menu and select **Start/Stop** (or press the **Start/Stop** key).
- Step 2.** Click the **Stimulus Display** Button, and select the Sweep Area Display Mode.

Stimulus Display Button	Sweep Area Display Mode
Stimulus Display: [Start/Stop]	The sweep start value and the sweep stop value.
Stimulus Display: [Center/Span]	The sweep center value and the sweep span value.

## Setting Frequency Display Resolution

Display resolution of the frequency data (sweep range, marker stimulus value, etc.) on the screen can be changed over the range from 1 mHz to 1 MHz. The actual setting value is not changed, but the indicated value is rounded in accordance with the display resolution.

### Procedure

- Step 1.** Right-click to open the shortcut menu and select **Display** (or press the **Display** key).
- Step 2.** Click the **More** button (or press the **Display** key again).
- Step 3.** Click on the **Freq Disp Resolution** box and select the desired frequency display resolution (**1 mHz, 10 mHz, ..., 1 MHz**).

## Confirm the Setting Status on the Screen

A summary of the E4991A setting status can be displayed on the screen (Figure 5-10 through Figure 5-12).

Figure 5-11

Operation Parameters Display

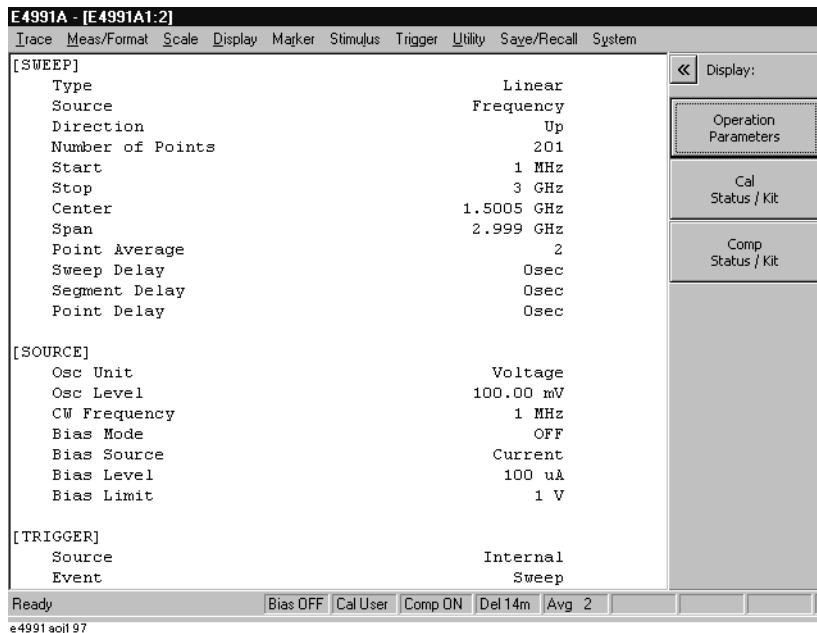
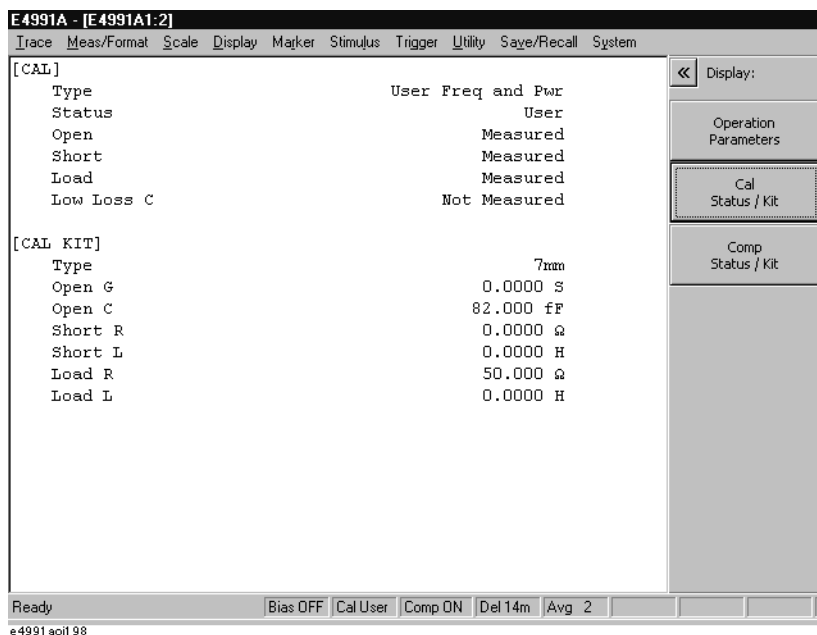
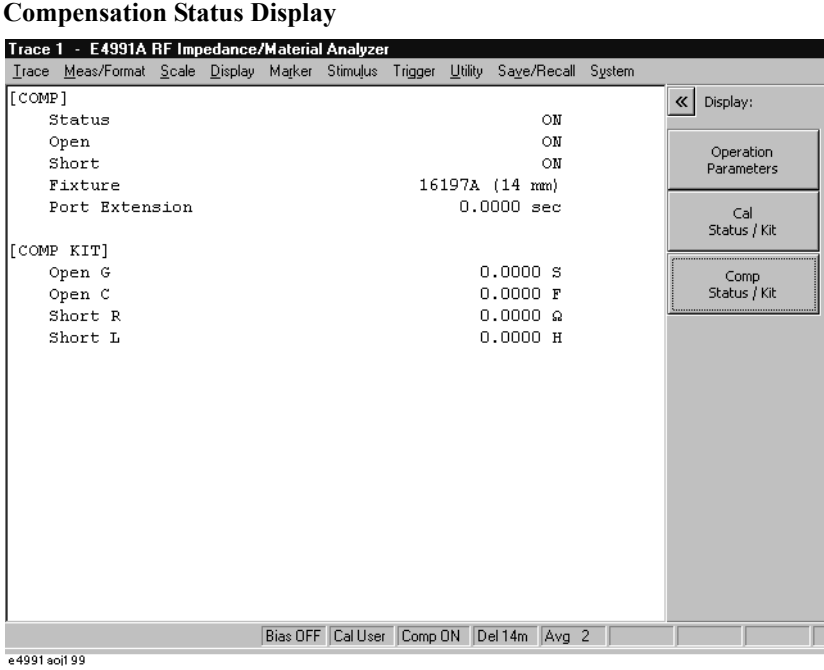


Figure 5-12

Calibration Status Display



**Figure 5-13**



**Procedure**

- Step 1.** Right-click to open the shortcut menu and select **Display** (or press the Display key).
- Step 2.** Click the **More** button (or press the Display key again).
- Step 3.** Click the **Operation Param Menu** button.
- Step 4.** Click to select the desired setting status display from the following buttons.

Setting status display selection button	Displayed setting status
<b>Operation Parameters</b>	Operation parameters (Figure 5-10)
<b>Cal Status / Kit</b>	Calibration status and calibration kit settings (Figure 5-11)
<b>Comp Status / Kit</b>	Compensation status and compensation kit settings (Figure 5-12)

## Continuous Phase Display Without Returning at $\pm 180^\circ$

When the phase measurement value continuously increases or decreases, the trace becomes discontinuous at  $+180^\circ$  or  $-180^\circ$  of the phase point because at this point the measurement values are replaced by  $-180^\circ$  and  $+180^\circ$ , respectively. The phase extension display function was designed to prevent such discontinuity and display the phase trace continuously.

The phase extension function can be set by following the procedure below.

### Procedure

- Step 1.** Click inside the window of the trace for which the phase extension display is to be set (or click the measurement parameter name area (e.g. **2:  $\theta_Z$  [°]**) in overlay display) (or press the **Trace** key) to make the trace active.
- Step 2.** Right-click to open the shortcut menu and select **Meas/Format** (or press the **Meas/Format** key).
- Step 3.** Click the **Expand Phase** button to toggle the phase extension display between **[On]** and **[Off]**.

Expand Phase Button Display	Phase Expansion Display
Expand Phase: <b>[On]</b>	On (The phase is possible to display under $-180^\circ$ or over $180^\circ$ .)
Expand Phase: <b>[Off]</b>	Off (The phase is displayed within the area of $-180^\circ$ to $180^\circ$ .)



## Selecting Phase Unit

You can set the phase unit used in setting the scale for phase measurement or in reading data with a marker by following the procedure below.

### Procedure

- Step 1.** Click inside the window of the trace for which the phase unit is to be set (or click the measurement parameter name area (e.g. **2:  $\theta z$  [°]**) in overlay display) (or press the **Trace** key) to make the trace active.
- Step 2.** Right-click to open the shortcut menu and select **Meas/Format** (or press the **Meas/Format** key).
- Step 3.** Click the **Phase Unit** Button to change the phase unit.

Phase Unit Button Display	Phase Unit
Phase Unit: [Radian]	Radian (rad)
Phase Unit: [Degree]	Degree (°)

---

## Displaying Trace Title on Measurement Display

It is possible to title each trace and show it on the display.

### Procedure

- Step 1.** Click inside the window of the trace you want to title (or click the measurement parameter name area (e.g. **2:  $\theta z$  [°]**) in overlay display) (or press the **Trace** key) to make the trace active.
- Step 2.** Right-click to open the shortcut menu and select **Display** (or press the **Display** key).
- Step 3.** Click the **More** button (or press the **Display** key again).
- Step 4.** Click the **Title** button. The **Edit Title** dialog box will appear (Figure 5-14).

Figure 5-14

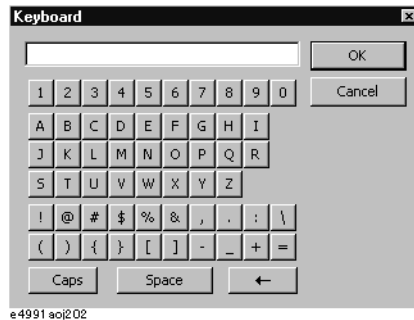
### Edit Title Dialog Box



- Step 5.** Click the **keyboard...** button to open the Keyboard dialog box (Figure 5-15) and use this dialog box (or an external keyboard) to input a title in the **Title** box.

Figure 5-15

### Keyboard Dialog Box



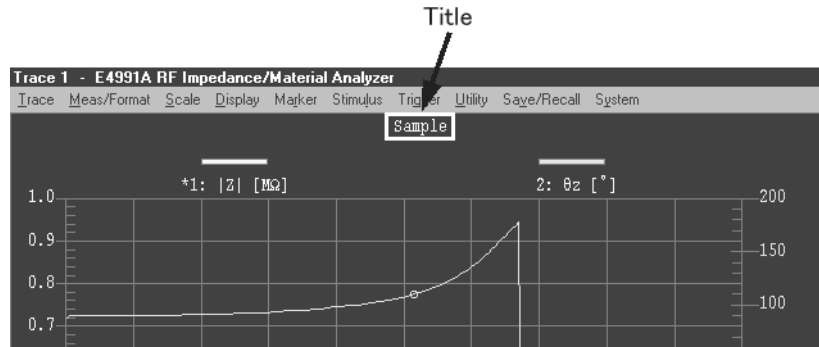
- Step 6.** Click the **OK** button in the **Edit Title** dialog box to enter the trace's title.

---

### NOTE

A trace's title may be revised at any time by again following the above procedure.

Figure 5-16 Title Display



---

## Changing Display Colors

The display colors of the characters and graphics on the display can be changed for each item.

### Procedure

- Step 1.** Right-click to open the shortcut menu and select **Display** (or press the **Display** key).
- Step 2.** Click the **More** Button (or press the **Display** key again).
- Step 3.** Click the **Color Setting Menu** Button.
- Step 4.** Click on the **Item** Box and select the item whose display color you want to change.

Item Box	Item to Change Display Color
Scalar 1 Data	Data trace of scalar trace 1
Scalar 1 Mem	Memory trace of scalar trace 1
Scalar 2 Data	Data trace of scalar trace 2
Scalar 2 Mem	Memory trace of scalar trace 2
Scalar 3 Data	Data trace of scalar trace 3
Scalar 3 Mem	Memory trace of scalar trace 3
Complex 1 Data	Data trace of complex trace 1
Complex 1 Mem	Memory trace of complex trace 1
Complex 2 Data	Data trace of complex trace 2
Complex 2 Mem	Memory trace of complex trace 2
Background	Background of trace display
Grid	Trace display grid

- Step 5.** Using the numeric entry dialog box that appears by right-clicking inside each color level setting box of **Red**, **Green** and **Blue** (or using the **ENTRY/NAVIGATION** block keys on the front panel), enter the color values for the selected item.

Color Level Setting Box	Setting Value
Red	Value of red color level (0: black to 255: pure red)
Green	Value of green color level (0: black to 255: pure green)
Blue	Value of blue color level (0: black to 255: pure blue)

---

# 6

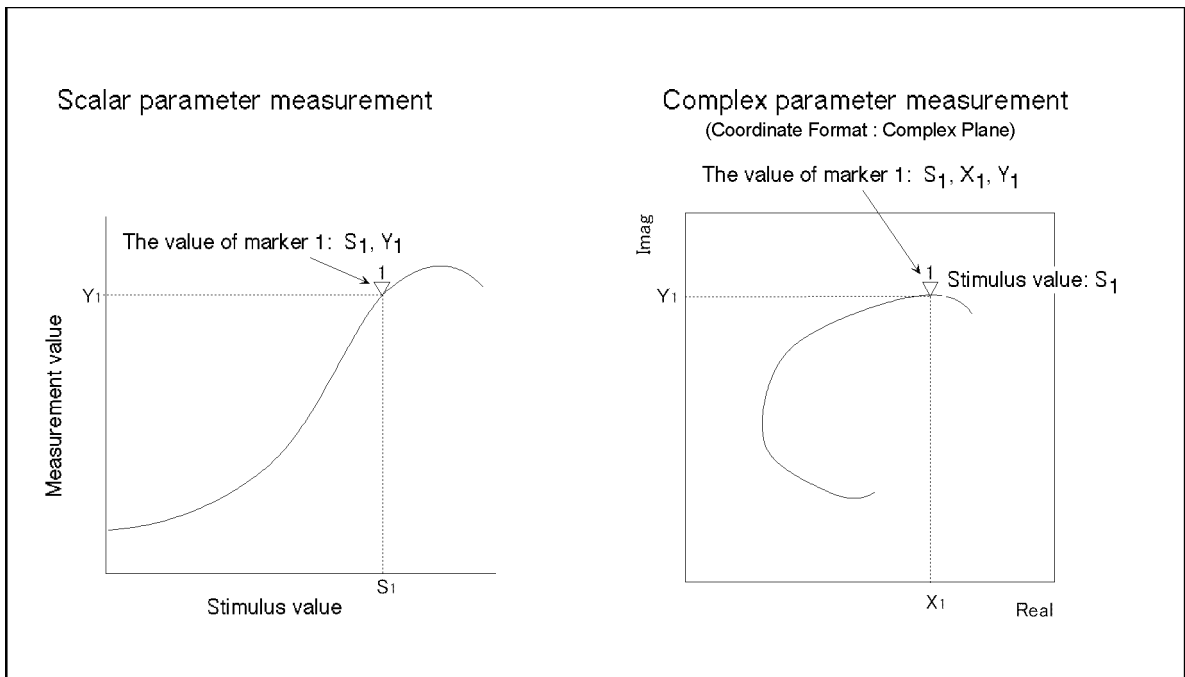
## Analysis of Measurement Results

This chapter explains how the measurement results of the E4991A are analyzed.

## Reading Value on the Trace by Specifying Stimulus Value

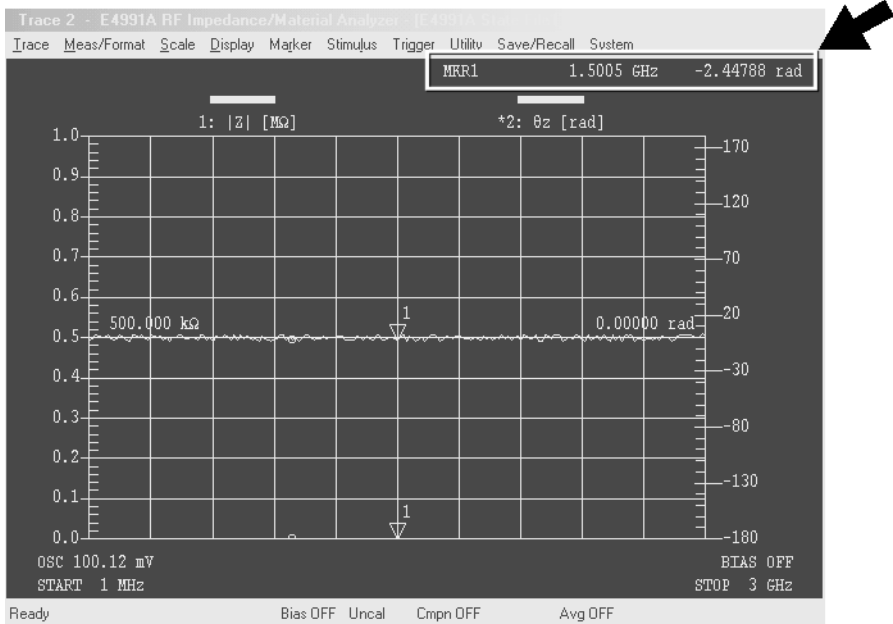
By using a marker, it is possible to read the measurement data numerically on the display.

Figure 6-1 Reading measurement data on the trace by using a marker.



e4991aoc100

Figure 6-2 Display of marker value (stimulus value, measurement value)



## Procedure

### Step 1. Display a marker on the trace (turn the marker “On”)








- Click inside the window of the trace to read the measurement value (or click the measurement parameter name area e.g. **2:  $\theta z$  [°]** in the case of overlay display) (or press **Trace**) to make the trace active.
- Right-click to open the shortcut menu and click **Marker** (or press **Marker**).
- Click and open the **Select Marker** box and click to select the marker to be used (**Marker R, Marker 1 to Marker 8**).

After the above operation, the selected marker turns on.

### Step 2. Move the Marker

A stimulus value indicating the marker position is displayed in the **Stimulus** box. A change in the stimulus value may move the marker.

The following methods can be used to change the value in the **Stimulus** box:

- Click the numeric box and unit box of the numeric entry dialog box that appears by right-clicking inside the box and enter the values of marker and stimulus.
- Click the s and t buttons in the upper-right part of the box to increase and decrease the marker stimulus value.
- Place the cursor on the marker's position on the trace (cursor icon changes from  to ) , move the cursor to the desired position on the trace while holding down the left mouse button, and then release the mouse button so that the marker moves to the desired position.
- When all character strings in the box are already selected (displayed in reverse text), enter the marker stimulus value by pressing the **ENTRY/NAVIGATION** Block key.
- When all character strings in the box are already selected (displayed in reverse), place the cursor **[|]** at the head of the character strings by pressing  or  and then press the  and  buttons or turn the  rotary knob to increase or decrease the stimulus value.

The marker value (stimulus value and measurement value) is displayed in the upper part of the measurement graph (Figure 6-2).

### Step 3. Deleting marker from trace (turn the marker “Off”)

- Click and open the **Select Marker** box and click to select the marker to turn off (**Marker R, Marker 1 to Marker 8**).
- Click **Selected Marker** and turn the marker off.

---

**NOTE**

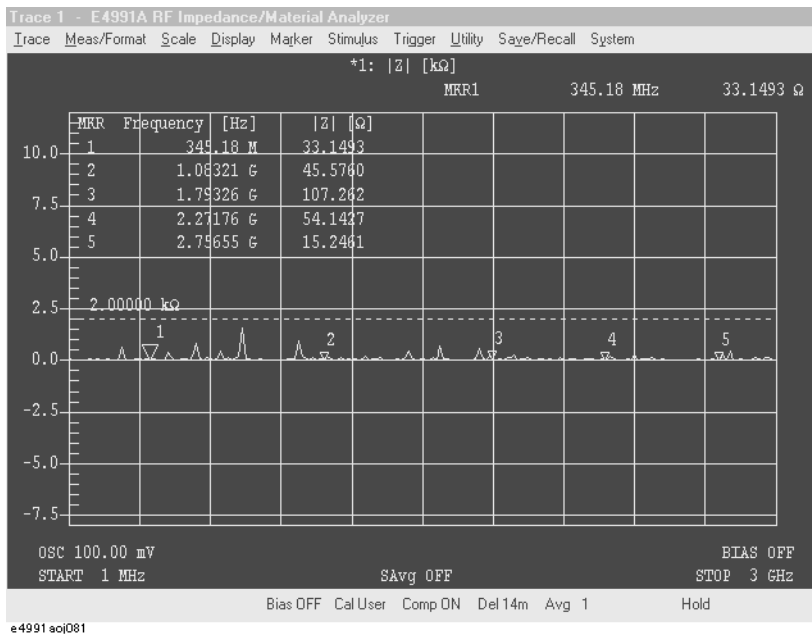
Click the **All Off** button to turn off all of the markers on the display.

## Displaying the Values of Plural Points on a Trace in a Value List

It is possible to place plural markers on a trace and display their respective values (stimulus value and measurement value) in a list.

Figure 6-3

### Marker List Display “On”



### Procedure

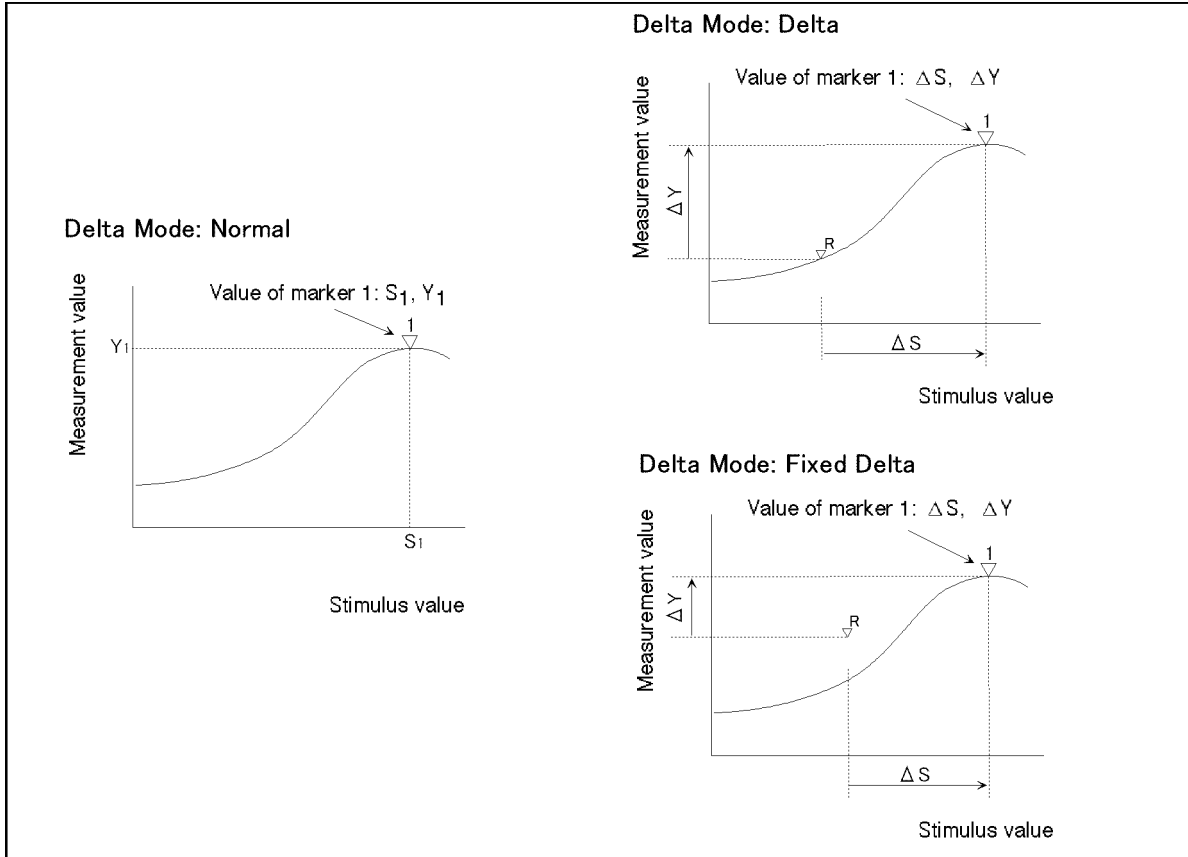
- Step 1.** Place plural markers on the trace according to “Reading Value on the Trace by Specifying Stimulus Value” on page 128.
- Step 2.** Click inside the window of the trace to display the marker list (or click the measurement parameter name area e.g. **2:  $\theta_z$  [°]** in the case of overlay display) (or press **Trace**) to make the trace active.
- Step 3.** Right-click to open the shortcut menu and click **Marker Function** (or press **Marker Fctn**).
- Step 4.** Click the **More** button (or press **Marker Fctn**).
- Step 5.** Click the **Marker List** button to turn the marker list display “on” (Figure 6-3).



## Reading Difference from Reference Point on a Graph (Delta Marker)

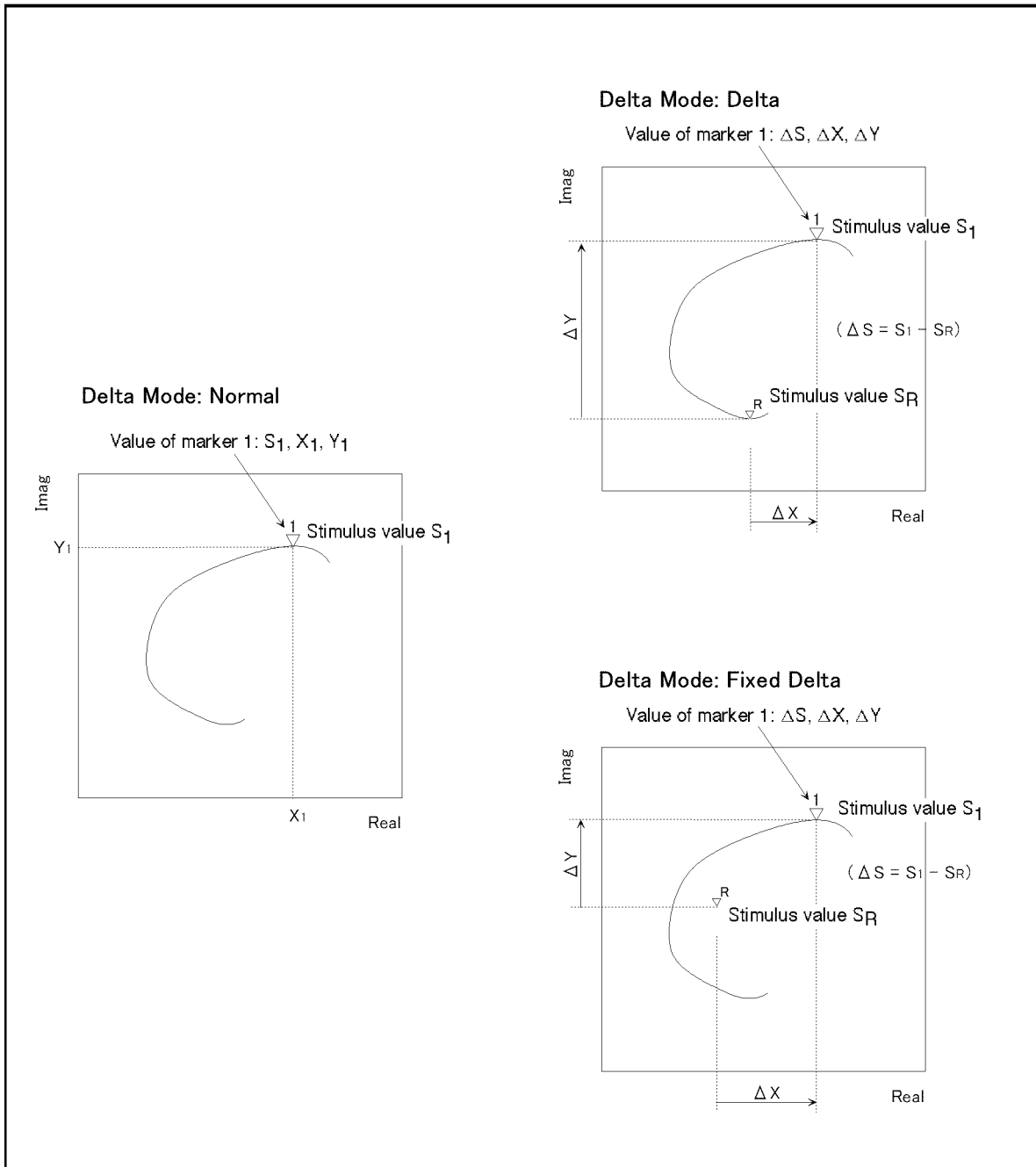
### Delta Marker Function

Figure 6-4 Delta Marker Mode in Scalar Parameter Measurement



e4991ace084

Figure 6-5 Delta Marker Mode in Plural Parameter Measurement



e4991a0e085

## Procedure

### Step 1. Delta Mode Selection

- a. Click inside the window of the trace using the Delta Marker function (or click the measurement parameter name area e.g. **2:  $\theta z$  [°]** in the case of overlay display) (or press **Trace**) to make the trace active.
- b. Right-click to open the shortcut menu and click **Marker** (or press **Marker**).
- c. Click to select **Marker R** from the **Select Marker** box.
- d. Click **Delta Marker Menu**.
- e. Click and select **Delta** or **Fixed Delta** from the **Delta Mode** box.

Delta Mode Box	Delta Mode
Normal	Normal (Delta Mode “off”)
Delta	Delta Mode
Fixed Delta	Fixed Delta Mode

### Step 2. Placing Marker R on reference point

Using the numeric entry dialog box that appears by right-clicking within the following box (or using the **ENTRY/NAVIGATION** block key on the front panel), enter the position of the reference point (Marker R) into each box:

Reference Marker Value Setting	Delta Mode
Stimulus Box	Stimulus value of Marker R
Delta Value Box	Measurement value of Marker R (Primary measurement parameter value) <sup>*1</sup>
Delta Aux Value Box	Secondary measurement parameter value of Marker R <sup>*1*2</sup>

\*1. Setting possible only when **Fixed Delta** is selected in step 1-e.

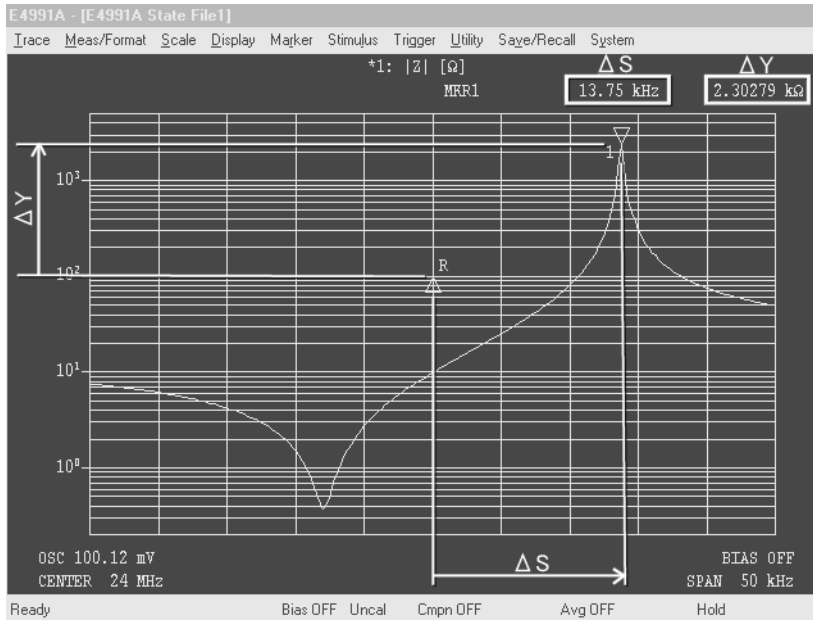
\*2. Setting possible only for complex parameter measurement.

### Step 3. Reading difference from reference point by using marker 1 to 8

- a. Click the << button.
- b. Click and select a Marker for value reading from the **Select Marker** box (**Marker 1 to Marker 8**).
- c. Using the numeric entry dialog box that appears by right-clicking within the **Stimulus** box (or using the **ENTRY/NAVIGATION** block key on the front panel), enter the Stimulus value (DS) of the difference on the reference point of Marker R into the **Stimulus** box.
- d. Read the marker value displayed in the upper-part of the measurement graph (Figure 6-6).

Figure 6-6

Delta Marker (Fixed Mode)

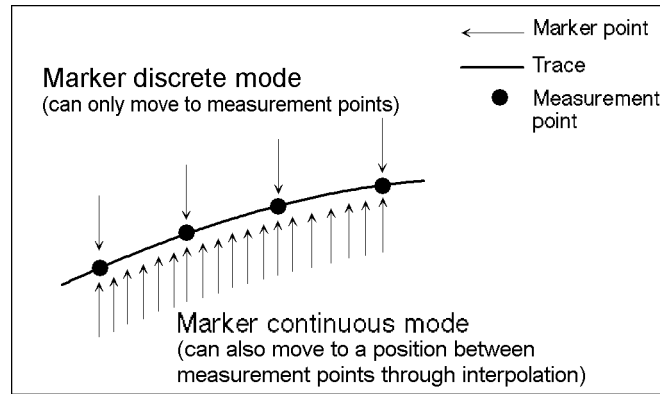


## Reading Only the Actual Measurement Point/Reading the Distance between Measurement Points through Interpolation

By setting the marker to continuous mode, the marker on the trace can freely move not only to an actual measurement point but also to a position within the distance between measurement points. Such an intermediary position can be automatically determined by an interpolation calculation.

**Figure 6-7**

### Markers' Continuous Mode and Discontinuous Mode



e4991 aoe086

### Procedure

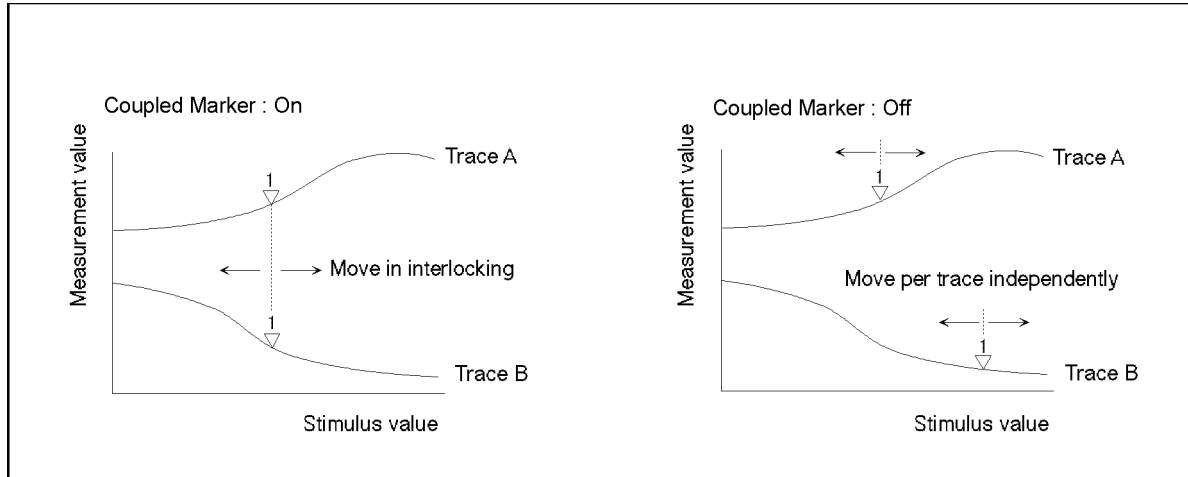
- Step 1.** Click inside the window of the trace to set a marker to continuous mode or discrete mode (or click the measurement parameter name area, e.g. **2:  $\theta z$  [°]** in the case of overlay display) (or press **Trace**) to make the trace active.
- Step 2.** Right-click to open the shortcut menu and click **Marker** (or press **Marker**).
- Step 3.** Click the **More** button (or press **Marker**).
- Step 4.** Click the **Marker** button to toggle the marker between continuous and discrete modes.

Marker Button Display	Marker Continuous/Discrete Mode
<b>Marker: [Continuous]</b>	Continuous mode (marker can move to any arbitrary point)
<b>Marker: [Discrete]</b>	Discrete mode (marker can move only to measurement points)

## Move the Marker for Each Trace Independently

You can move the marker either for each trace independently or while it's interlocked with all of the traces.

Figure 6-8 Marker Interlocking On/Off



e4991a0e087

- Step 1.** Right-click to open the shortcut menu and click the **Marker** (or press **Marker**).
- Step 2.** Click the **More** button (or press **Marker**).
- Step 3.** Click the **Coupled Marker** button to toggle marker interlocking “On/Off”.

Coupled Marker Button Display	Marker Interlocking
Coupled Marker: [On]	On (marker moves with all traces interlocked)
Coupled Marker: [Off]	Off (marker moves for each trace independently)

## Selecting Marker Value Display for Plural Parameters

When using a marker for plural traces, the marker value is displayed in the form of two scalar parameters converted from two plural parameters (main and sub-parameters). This conversion method enables selection from six kinds of marker values (Table 6-1), irrespective of the coordination format set (polar coordination, plural planes, Smith chart, Admittance chart).

**Table 6-1                      Marker Value Display Mode and Marker Value Displayed**

Marker Value Display Mode (selection in Smith/Polar box)	Marker Value	
	Main Parameter	Sub-parameter
<b>Real Imag</b>	Actual number component	Imaginary number component
<b>LinMag Phase</b>	Amplitude (linear)	Phase
<b>LogMag Phase</b>	Amplitude (log, dB unit)	Phase
<b>R+jX</b>	Resistance (actual number component of plural impedances <sup>*1</sup> )	Reactance (Imaginary number component of plural impedances <sup>*1</sup> )
<b>G+jB</b>	Conductance (actual number component of plural admittances <sup>*2</sup> )	Susceptance (Imaginary number component of plural admittances <sup>*2</sup> )
<b>Swr Phase</b>	Standing wave ratio	Phase of reflection coefficient

\*1. In case of measuring plural impedances (Z), the same value is displayed as when **Real Imag** is selected.

\*2. In case of measuring plural admittances (Y), the same value is displayed as when **Real Imag** is selected.

## Analysis of Measurement Results

### Selecting Marker Value Display for Plural Parameters

The preset marker value display mode is set for each coordination format according to Table 6-2:

**Table 6-2** Preset marker value display modes

Coordination Format (selected in Format box)	Setting of preset marker value display mode
<b>Complex</b> (Plural planes)	<b>Real Imag</b>
<b>Polar</b> (Polar coordinate)	<b>LinMag Phase</b>
<b>Smith</b> (Smith chart) <sup>*1</sup>	<b>R+jX</b>
<b>Admittance</b> (Admittance chart) <sup>*1</sup>	<b>G+jB</b>

\*1. Can only be selected for measuring plural reflection coefficient  $\Gamma$ .

### Procedure

- Step 1.** Click inside the window of the trace to change the marker value display mode (or press **Trace**) and make the trace active.
- Step 2.** Right-click to open the shortcut menu and click the **Marker Function** (or press **Marker Fctn**).
- Step 3.** Click the **More** button (or press **Marker Fctn**).
- Step 4.** Click and select the Marker value display mode from the **Smith/Polar** box (see Table 6-1).



---

## Selecting Marker Analysis Target Trace (Data/Memory)

When the memory trace is used according to the procedures of “Trace Comparison Using Memory Trace” on page 116, it is necessary to select the memory trace as the target of analysis by the marker (data trace is the preset setting).

### Procedure

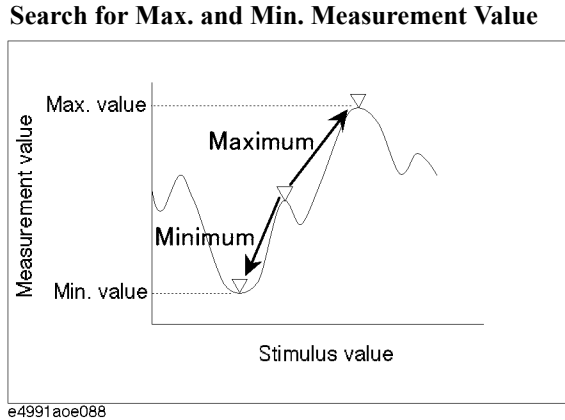
- Step 1.** Click inside the window of the trace to select it as the target trace for marker analysis (or click the measurement parameter name area, e.g. **2:  $\theta z$  [°]** in the case of overlay display) (or press **Trace**) and make the trace active.
- Step 2.** Right-click to open the shortcut menu and click **Marker** (or press **Marker**).
- Step 3.** Click the **Marker On** button and select the marker analysis target trace.

Marker On Button Display	Marker Analysis Target Trace
Marker On: [Data]	Data trace
Marker On: [Memory]	Memory trace

## Search for Max. and Min. Measurement Value

By using the functions of max. search and min. search, you can search for the maximum and minimum points of measurement value on the trace and move the marker to these points.

Figure 6-9



### Procedure

#### Step 1. Activate the marker to be used.

- Click inside the window of the trace on which you want to search for maximum and minimum values (or click the measurement parameter name area, e.g. **2:  $\theta z$  [°]** in the case of overlay display) (or press **Trace**) to make the trace active.
- Right-click to open the shortcut menu and click **Marker** (or press **Marker**).
- Click and open the **Select Marker** box and click to select the marker to be used (**Marker R**, **Marker 1** to **Marker 8**).

The above operation makes the selected marker active.

#### Step 2. Move the marker to max. and min.

- Right-click to open the shortcut menu and click the **Marker Function** (or press **Marker Fctn**).
- Click the **Search Type** drop-down menu to select **Maximum** or **Minimum**.

Search Type Menu	Marker Search
<b>Maximum</b>	The point where the measurement value on the trace is maximum.
<b>Minimum</b>	The point where the measurement value on the trace is minimum.

- Click the **Search** button to execute the search for the maximum value or the minimum value.

---

**NOTE**

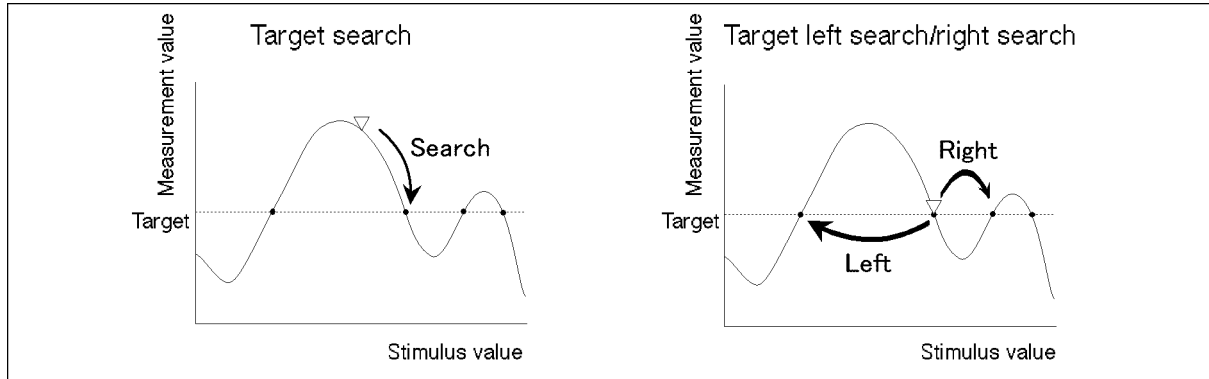
---

When a partial search area has been specified according to the procedure of “Specify the Partial Search Area” on page 153, the marker moves to the maximum value or the minimum value on the trace within this area.

## Search for Target Point of Measurement Value

By using the target search function, you can search for a point that has a specified measurement value on the trace (target) and move the marker to that point.

**Figure 6-10** Target Search Function



e4991ace089

### Procedure

#### Step 1. Setting target (target measurement value)

- a. Click inside the window of the trace on which you want to execute a target search (or click the measurement parameter name area, e.g. **2:  $\theta z$  [°]** in the case of overlay display) (or press **Trace**) to make the trace active.
- b. Right-click to open the shortcut menu and click **Marker Function** (or press **Marker Fctn**).
- c. Click the **Search Def&Range Menu** button
- d. Using the numeric entry dialog box that appears by right-clicking inside the **Target Value** box (or using the **ENTRY/NAVIGATION** block key on the front panel), enter the measurement value of the search into the **Target Value** box.

#### Step 2. Executing target search

- a. Click the **<<** button.
- b. Click the **Search Type** drop-down menu to select **Target**.

Search Type Menu Item	Marker Search
Target	The point having the target set on the trace as a measurement value.

- c. Click the **Search** button to execute the target search.

### NOTE

When a partial search area has been specified according to the procedure of “Specify the Partial Search Area” on page 153, the marker moves to the maximum or minimum value on the trace within this area.

When plural target points exist on a trace, the marker moves from its position before the search to the nearest target having the same measurement value (Figure 6-10).

**Step 3. Searching for other targets on a trace**

When plural target points exist on the trace, if you click on the **Left** or the **Right** button, you can move the marker from the present target to the next target in the designated direction.

<b>Button for moving to other target</b>	<b>Function</b>
<b>Left</b>	This button searches from the present marker position in the direction of smaller stimulus values and moves the marker to the first target found.
<b>Right</b>	This button searches from the present marker position in the direction of larger stimulus values and moves the marker to the first target found.

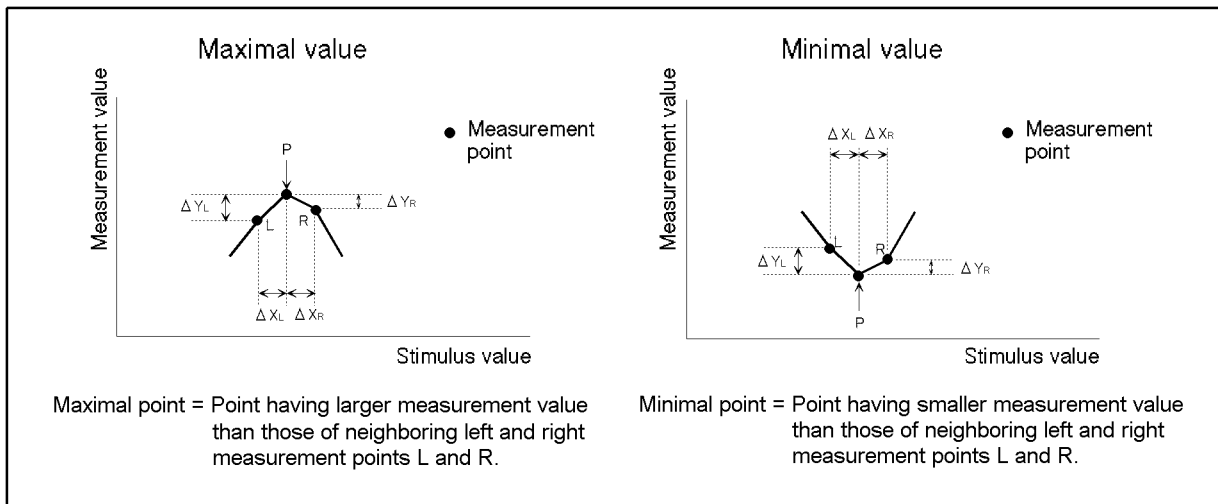
## Peak Search

By using the peak search function, you can search for a peak on a trace and move the marker to this peak.

### Maximal Point and Minimal Point

Maximal points (minimal points) mean those measurement points having a larger (smaller) value than those of both their neighboring left and right measurement points (see Figure 6-11).

Figure 6-11 Maximal Point and Minimal Point



e4991a0e091

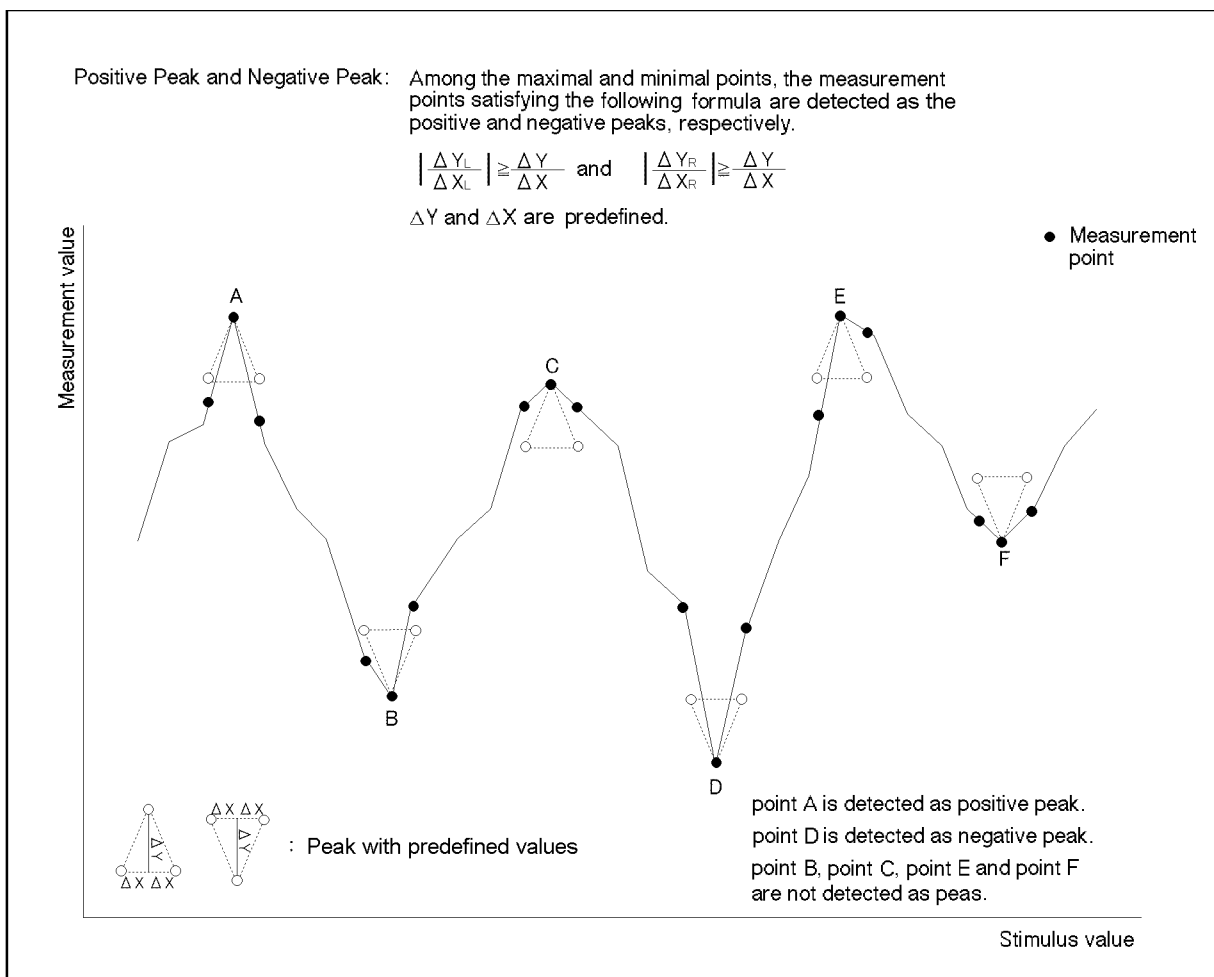
### Positive Peak and Negative Peak

To determine positive or negative peaks, we assume peak areas formed by three measurement points, i.e. one measurement point on each side of a maximal or minimal point. Among maximal (minimal) points (defined in Figure 6-11), a positive (negative) peak is defined as a point having absolute values of the left- and right-side linear inclinations that are larger than a certain predefined inclination ( $\frac{\Delta Y}{\Delta X}$ ) (Figure 6-12). By

predefining ( $\frac{\Delta Y}{\Delta X}$ ) in the E4991A, you can search for positive and negative peaks

corresponding to desired values while excluding maximal and minimal points that do meet the defined values.

**Figure 6-12** Positive Peak and Negative Peak

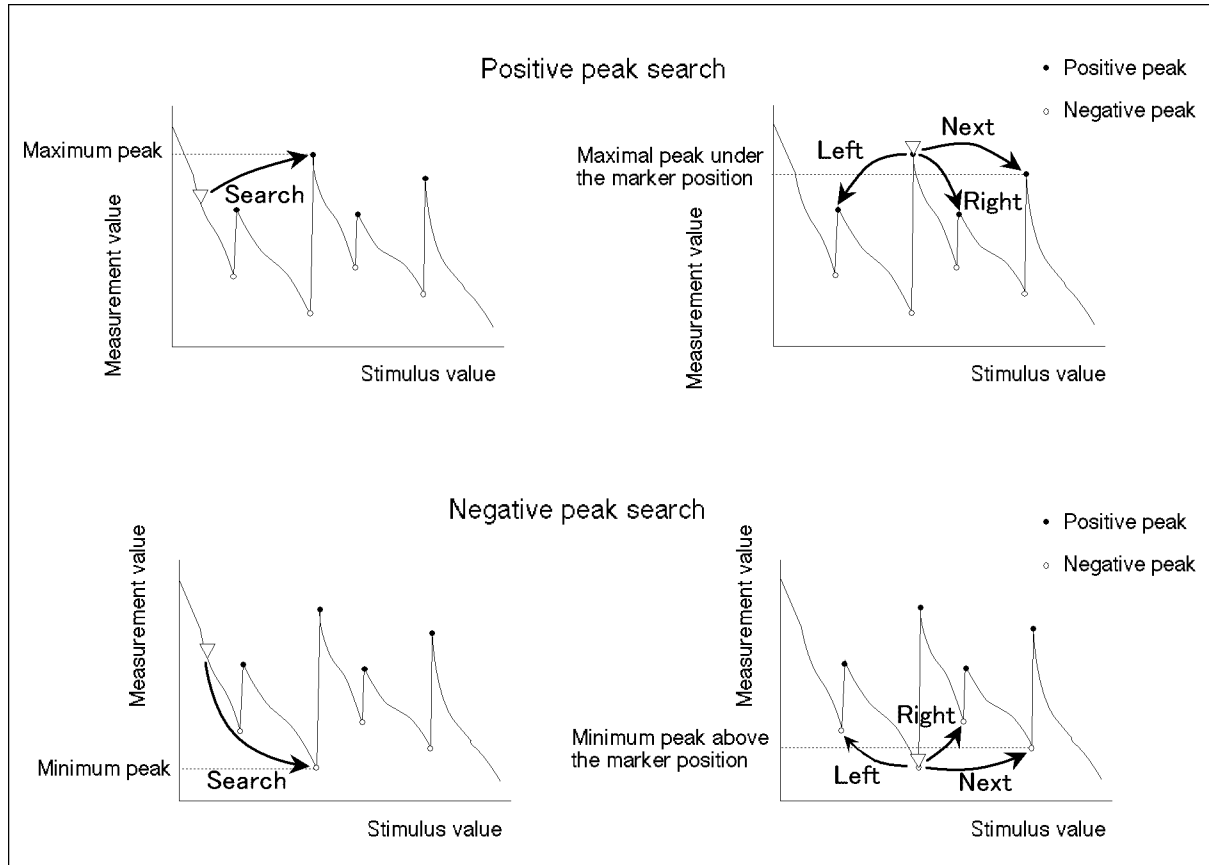


e4991a0e092

## Outline of Peak Search Function

According to the definition of the peak, the E4991A can execute the peak search as shown in Figure 6-13:

Figure 6-13 Peak Search Function



e4991 aoe090

## Procedure

### Step 1. Define Peak

- a. Click inside the window of the trace on which you want to execute peak search. (or click the measurement parameter name area, e.g. **2:  $\theta z$  [°]** in the case of overlay display) (or press **Trace**) to make the trace active.
- b. Right-click to open the shortcut menu and click **Marker Function** (or press **Marker Fctn**).
- c. Click the **Search Def&Range Menu** button.
- d. Using the numeric entry dialog box that appears by right-clicking inside the **Peak Delta X** and **Peak Delta Y** boxes (or using the **ENTRY/NAVIGATION** block key), enter the



values to define the peak into the **Peak Delta X** and **Peak Delta Y** boxes.

Peak Defining Box	Definition of Peak
Peal Delta X	$\Delta X$ (see Figure 6-11)* <sup>1</sup>
Peak Delta Y	$\Delta Y$ (see Figure 6-11)* <sup>2</sup>

\*1. Preset setting, 10M (= 10.000.000)

\*2. Preset setting, 1

**NOTE** Instead of directly entering numeric values for  $\Delta X$  and  $\Delta Y$ , it is possible to define the peak by using the marker on the trace. See “Define the Peaks Using Marker” on page 148.

### Step 2. Specify the marker to be used

- Right-click to open the shortcut menu and click **Marker** (or press **Marker** ).
- From the **Select Marker** drop-down menu, select the Marker to use for the peak and activate it (**Marker R**, **Marker 1** to **Marker 8**).

**NOTE** To turn unnecessary markers off, press the **Selected Marker** button after selecting the marker in the **Select Marker** drop-down menu.

### Step 3. Execute peak search

- Right-click to open the shortcut menu and click **Marker Function** (or press **Marker Fctn** ).
- From the **Search Type** drop-down menu, select **Positive Peak** or **Negative Peak**.

Search Type Drop-down Menu	Marker Search
Positive Peak	Positive Peak (see Figure 6-11)
Negative Peak	Negative Peak (see Figure 6-11)

- Click one of the following Peak Search buttons to execute the peak search.

Peak Search Button	Function
Search	This moves the marker to the peak having the maximum measurement value among the peaks on the trace.
Next	In the case of positive peak: This moves the marker to the next maximum peak having a smaller measurement value than that in the position of the present active marker. In the case of negative peak: This moves the marker to the next minimum peak having a larger measurement value than that in the position of the present active marker.

Analysis of Measurement Results  
**Peak Search**

Peak Search Button	Function
Left	This executes peak search from the position of the present active marker to the left (toward smaller stimulus values) and moves the marker to the first detected peak.
Right	This executes peak search from the position of the present active marker to the right (toward larger stimulus values) and moves the marker to the first detected peak.

---

**NOTE** When a partial search area has been specified according to the procedure of “Specify the Partial Search Area” on page 153, the marker moves to the peak existing within this area.

---

**Define the Peaks Using Marker**

You can set the peak definitions by placing the marker directly on the maximal and minimal points on the trace (Figure 6-14). In other words, the marker values at these points establish the peak definitions.

- Step 1.** Place the marker (and the reference marker) on the desired position in accordance with Figure 6-14.
- Step 2.** Click inside the window of the trace used to define the peak (or the measurement parameter name area, e.g. 2: qz [×] in the case of overlay display) (or press **Trace**) to make the trace active.
- Step 3.** Right-click to open the shortcut menu and click **Marker Function** (or press **Marker Fctn**).
- Step 4.** Click the **Search Def&Range Menu** button.
- Step 5.** Click the **Marker to Peak Delta** button to define the peak according to the position of the present marker (and the reference marker). The defined results are assigned automatically into the **Peak Delta X** and the **Peak Delta Y** boxes.

Name of Box	Value Assigned
<b>Peak Delta X</b> Box	In the case of <b>Delta Mode: Normal</b> The absolute value of difference between the marker stimulus value and the stimulus value of the measurement point adjacent to the left of the marker ( $\Delta X$ ).
	In the case of <b>Delta Mode: Delta</b> or <b>Fixed Delta</b> The absolute value of the marker stimulus value (difference from the reference marker) ( $\Delta X$ ).
<b>Peak Delta Y</b> Box	In the case of <b>Delta Mode: Normal</b> The absolute value of difference between the marker measurement value and the measurement value of the measurement point to the immediate left of the marker ( $\Delta Y$ ).
	In the case of <b>Delta Mode: Delta</b> or <b>Fixed Delta</b> The absolute value of the marker measurement value (difference from the reference marker) ( $\Delta Y$ ).

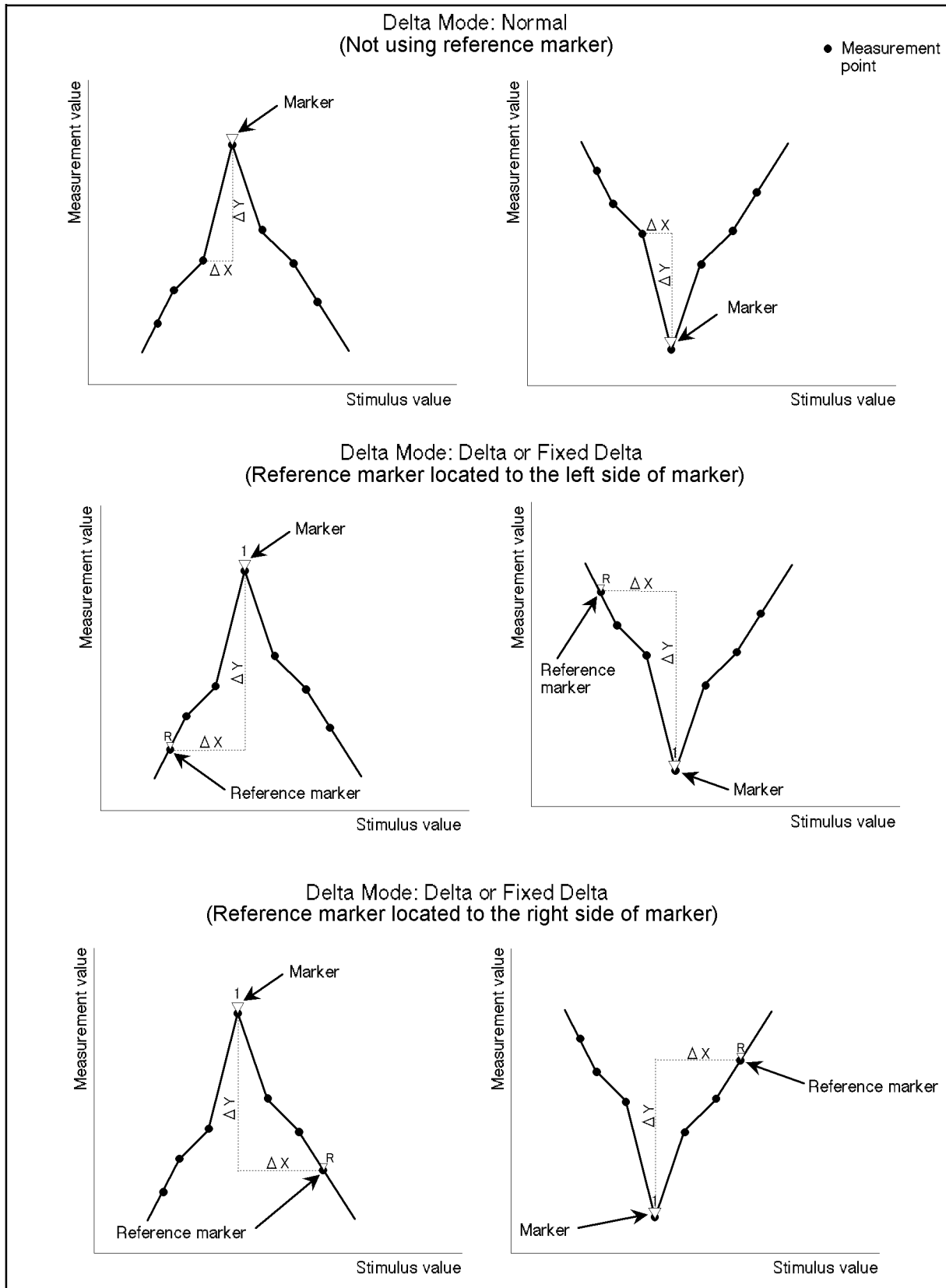
---

**NOTE**

---

If you do not place the marker on the maximal and minimal points, you may assign the marker value at this time as the definition of peak.

Figure 6-14 Definition of Peak by Using Marker



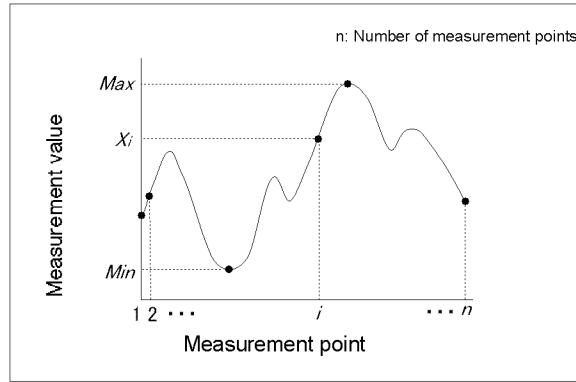
e4991a0e093

## Working Out Trace Average, Standard Deviation, and Peak to Peak to Peak

Based on the measurement value, you can work out statistical data such as average, standard deviation, and peak to peak.

**Figure 6-15**

**Parameters to Calculate Statistical Data**



e4991a0e096

**Table 6-3**

**Definitions of Statistical Data**

Statistical Data	Definition
Average ( <b>mean</b> )	$\frac{\sum_{i=1}^n x_i}{n}$ <p>where n: number of measurement points, xi: measurement value of the number i of measurement points</p>
Standard Deviation ( <b>s. dev</b> )	$\sqrt{\frac{\sum_{i=1}^n (x_i - \text{mean})^2}{n - 1}}$ <p>where n: number of measurement points, xi: measurement value of the number i of measurement points, mean: average value</p>
Peak to Peak ( <b>peak-peak</b> )	<p><math>Max - Min</math></p> <p>where Max: maximum measurement value, Min: minimum measurement value</p>

### Procedure

- Step 1.** Click inside the window of the trace whose statistical data you want to display (or the measurement parameter name area, e.g. **2:  $\theta z$  [°]** in the case of overlay display) (or press **Trace**) to make the trace active.
- Step 2.** Right-click to open the shortcut menu and click **Marker Function** (or press **Marker Fctn**).

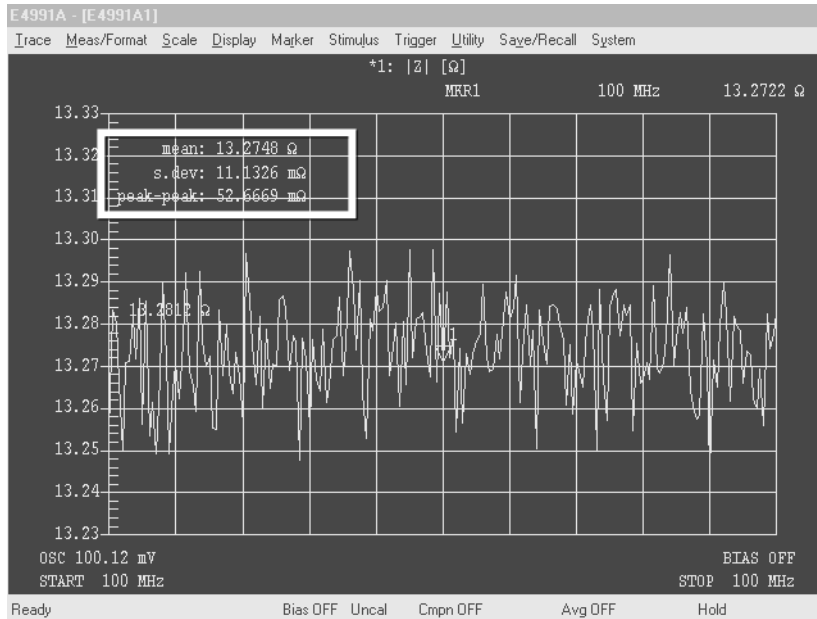
Analysis of Measurement Results  
Working Out Trace Average, Standard Deviation, and Peak to Peak

**Step 3.** Click the **More** button (or press **Marker Fctn**).

**Step 4.** Click the **Statistics** button to turn on the display of statistical data (Figure 6-16).

Figure 6-16

Display of Statistical Data



**NOTE**

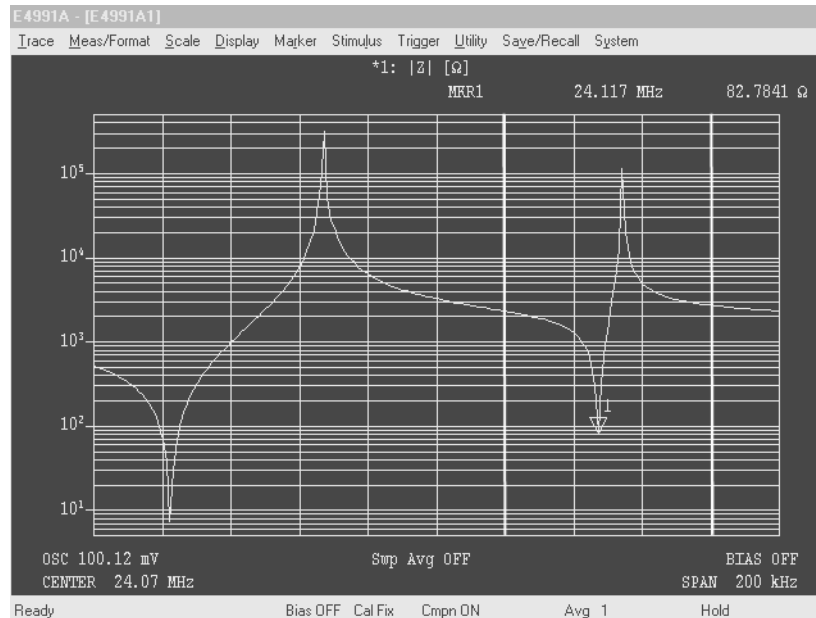
When a partial search area has been specified according to the procedure of “Specify the Partial Search Area” on page 153, the statistics data is worked out according to the measurement value within this area.

## Specify the Partial Search Area

By specifying a partial search area, you can execute the search function within this area.

Figure 6-17

### Specify Partial Search Area and Search for Minimum Point



## Procedure

### Step 1. Setting the lower limit of partial search area:

- a. Click inside the window of the trace on which you want to set a partial search area (or click the measurement parameter name area, e.g. **2:  $\theta z$  [°]** in the case of overlay display) (or press **Trace**) to make the trace active.
- b. Move the active marker to the lower limit of the partial search.
- c. Right-click to open the shortcut menu and click **Marker Function** (or press **Marker Fctn**).
- d. Click the **Search Def & Range Menu** button.
- e. Click the **Partial Search** button and turn the search function on.
- f. Click the **Marker to Left Range** button and set the position of the present active marker to the lower limit value of the partial search area.


By completing the above operation, you can display on the graph the straight line showing the lower limit value of the partial search area.

### Step 2. Setting the upper limit of partial search area:

- a. Move the active marker to the upper limit of the partial search.

## Analysis of Measurement Results

### Specify the Partial Search Area

- b. Right-click to open the shortcut menu and click **Marker Function** (or press ).
- c. Click the **Search Def & Range Menu** button.
- d. Click the **Marker to Right Range** button and set the position of the present active marker on the upper limit of the partial search area.

By completing the above operation, you can display on the graph the straight line showing the upper limit of the partial search area.

---

#### NOTE

Click the **Mkr Delta to Search Range** button when marker R and marker 1 (or markers 2 to 8) are placed on the lower limit value and the upper limit value (or on the upper limit value and the lower limit value), respectively. This allows you to instantly set the partial search area.

---



---

## Execution of Automatic Search in Each Sweep (Search Tracking)

By turning on Search Tracking before clicking the execution button, you can repeat the search every time a sweep is finished.

### Procedure

- Step 1.** Click inside the window of the trace on which you want to set search tracking (or the measurement parameter name area, e.g. **2:  $\theta z$  [°]** in the case of overlay display) (or press **Trace**) to make the trace active.
- Step 2.** Right-click to open the shortcut menu and click **Marker Function** (or press **Marker Fctn**).
- Step 3.** Click the **Search Track** button to turn search tracking on.

## Changing Marker Stimulus Value Display to Time/Relaxation Time

You can change the marker stimulus value shown on the display to time/relaxation time.

### Procedure

- Step 1.** Click inside the window of the trace on which you want to change the marker stimulus value (or the measurement parameter name area, e.g. **2:  $\theta z$  [°]** in the case of overlay display) (or press **Trace**) to make the trace active.
- Step 2.** Right-click to open the shortcut menu and click **Marker Function** (or press **Marker Fctn**).
- Step 3.** Click the **More** button (or press **Marker Fctn**).
- Step 4.** Select the marker stimulus value display from the **Marker X Axis** drop-down menu.

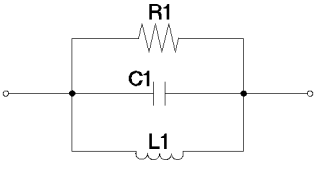
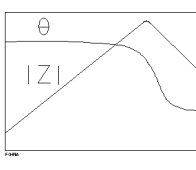
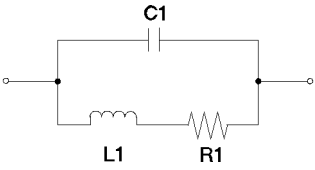
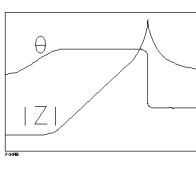
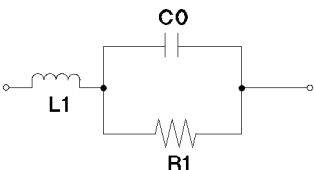
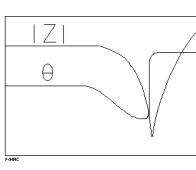
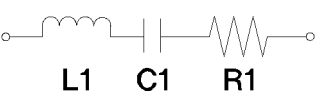
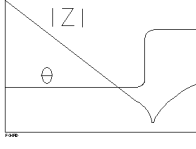
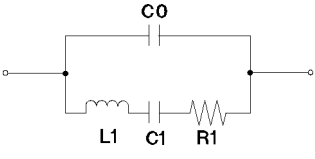
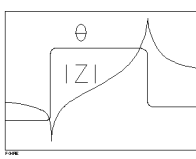
Marker X Axis Drop-down Menu	Marker Stimulus Value Display
Stimulus	Stimulus value (preset setting)
Time	Time (time from the sweep start until the finish of measurement of the marker position)
$1/(2*\pi*F)$	Relaxation time = $\frac{1}{2\pi F}$ (F = frequency [Hz])

## Calculation of Equivalent Circuit Parameter and Simulation of Frequency Characteristics

### Calculation of Equivalent Circuit Parameter based on Measurement Results

The E4991A is provided with four types of 3-element equivalent circuits and one type of 4-element equivalent circuit. It is possible to calculate the equivalent circuit parameter based on the sample measurement results as well as to display the frequency characteristics on the screen based on the input equivalent circuit parameter.

**Table 6-4 Selection of Equivalent Circuit**

Equivalent Circuit Model	Typical Frequency Characteristics	DUT Example
<b>A</b> 		Inductor with high core loss
<b>B</b> 		Inductor Resistor
<b>C</b> 		High-value resistor
<b>D</b> 		Capacitor
<b>E</b> 		Resonator

\*1. Measurement parameter:  $|Z| - \theta$ , Sweep type: log, Vertical axis:  $|Z|$  is log and  $\theta$  is linear

## Analysis of Measurement Results


### Calculation of Equivalent Circuit Parameter and Simulation of Frequency Characteristics

\*2. Measurement parameter:  $|Z| - \theta$ , Sweep type: linear (or log), Vertical axis:  $|Z|$  is log and  $\theta$  is linear

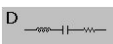
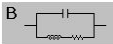
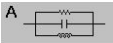
#### Procedure

##### Step 1. Executing DUT measurement using frequency as sweep parameter

##### Step 2. Selecting Equivalent Circuit

- Right-click to open the shortcut menu and click **Utility** (or press ).
- Click the **Equivalent Circuit Menu** button.
- Click the **Select Circuit** button.
- Select the desired equivalent circuit model among the five equivalent circuit models.

Equivalent Circuit Model Selection Button	Marker Stimulus Value Display
	Equivalent circuit: A
	Equivalent circuit: B
	Equivalent circuit: C
	Equivalent circuit: D
	Equivalent circuit: E



##### Step 3. Calculating equivalent circuit parameter

- Click the **<<** button.
- Click the **Calculate Parameters** button to execute calculation of the equivalent circuit parameter.

The calculated equivalent circuit parameters are displayed in each box of **R1**, **C1**, **L1** and **C0**.

### Frequency Characteristics Simulation based on Equivalent Circuit Parameters

#### Procedure

---

**NOTE**

When executing simulation of frequency characteristics based on the equivalent circuit parameter calculated according to the procedure of “Calculation of Equivalent Circuit Parameter based on Measurement Results” on page 157, only Step 4 needs to be executed.

---

##### Step 1. Setting the measurement conditions

## Analysis of Measurement Results

### Calculation of Equivalent Circuit Parameter and Simulation of Frequency Characteristics

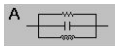
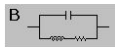

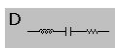
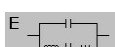
Set the frequency characteristics to the desired measurement conditions (measurement parameter, sweep conditions).

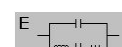
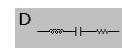
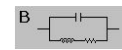
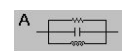
#### NOTE

Be sure to set the sweep parameter to frequency.

#### Step 2. Selecting equivalent circuit

- a. Right-click to open the shortcut menu and click **Utility** (or press **Utility**).
- b. Click the **Equivalent Circuit Menu** button.
- c. Click the **Select Circuit** button.
- d. Select the desired equivalent circuit model from among the five equivalent circuit models.

Equivalent Circuit Model Selection Button	Equivalent Circuit
	Equivalent circuit: A
	Equivalent circuit: B
	Equivalent circuit: C
	Equivalent circuit: D
	Equivalent circuit: E



#### Step 3. Entering Equivalent Circuit Parameter value

- a. Click the **<<** button.
- b. Enter the equivalent circuit parameter values into each box of **R1**, **C1**, **L1**, **C0**.

#### Step 4. Executing frequency characteristics simulation

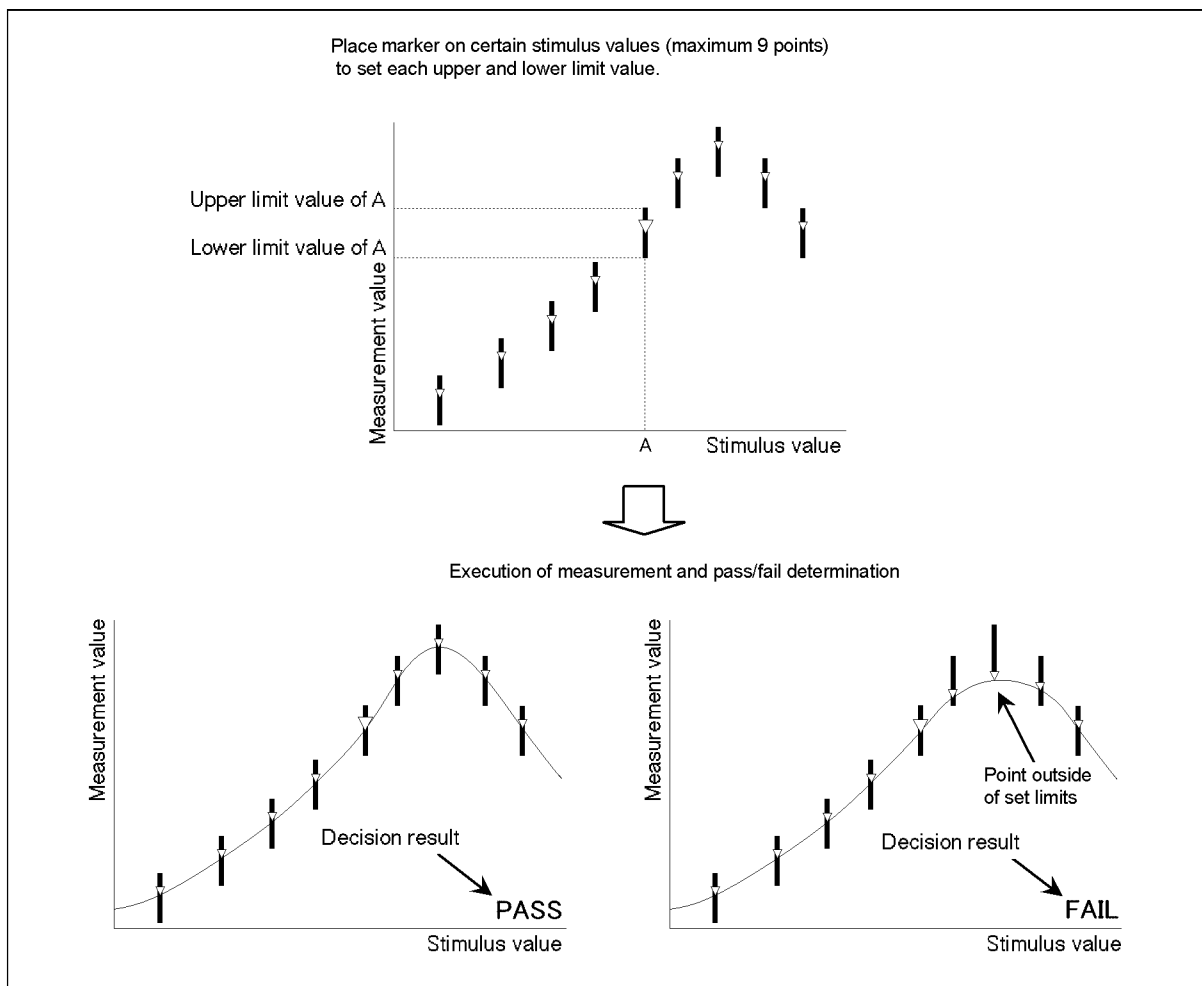
Click the **Simulate Freq-Char** button or the **Simulate Freq-Char of All Traces** to execute frequency characteristics simulation.

Frequency Characteristics Simulation Execution Button	Purpose of Simulation
<b>Simulate Freq-Char</b>	To display the simulation result for the present active trace by using its memory trace.
<b>Simulate Freq-Char of All Traces</b>	To display the simulation result for all traces displayed on the display by using each memory trace.

## Setting a Limit to the Trace and Making a Pass/Fail Determination

By using the marker limit test functions, you can set a limit to a trace and make a pass/fail determination on the measured results (Figure 6-18).

Figure 6-18 Marker Limit Test Function



e4991 aoe097

## Analysis of Measurement Results

### Setting a Limit to the Trace and Making a Pass/Fail Determination

#### Procedure

##### Step 1. Setting marker position and its upper limit and lower limit values

- a. Click inside the window of the trace on which you want to execute the marker limit test (or click the measurement parameter name area, e.g. **2:  $\theta z$  [°]** in the case of overlay display) (or press **Trace**) to make the trace active.
- b. Right-click to open the shortcut menu and click **Marker Function** (or press **Marker Fctn**).
- c. Click the **More** button (or press **Marker Fctn**).
- d. Click the **Limit Test Menu** button to display the Limit Marker Test Setup Table (Figure 6-19).

Figure 6-19 Limit Marker Test Setup Table

Marker Name	Limit Test On/Off Status	Marker Stimulus Value	Upper Limit	Lower Limit	Limit Test Result
R	Off	0	0	0	----
1	Off	1.5005 G	0	0	----
2	Off	0	0	0	----
3	Off	0	0	0	----
4	Off	0	0	0	----
5	Off	0	0	0	----
6	Off	0	0	0	----
7	Off	0	0	0	----
8	Off	0	0	0	----
&LL	Off				----

Limit Test: [ Off ]	
Select Marker:	Marker 1
Test Marker: [ Off ]	
Stimulus: Hz	0
Upper: $\Omega$	0
Lower: $\Omega$	0

- e. Use the **Select Marker** drop-down menu to select the marker to be used for limit setting (**Marker R**, **Marker 1** to **Marker 8**).

#### NOTE

If you first select the marker, the **Test Marker** button automatically turns on. When the **Test Marker** button is off, you should click this button to turn it on.

- f. For the markers selected in Step 1e. above, enter the values into the **Stimulus** box, **Upper** box, and **Lower** box.

#### Limit Marker Setting Box

#### Setting

Stimulus

Marker Position (stimulus value)

## Analysis of Measurement Results

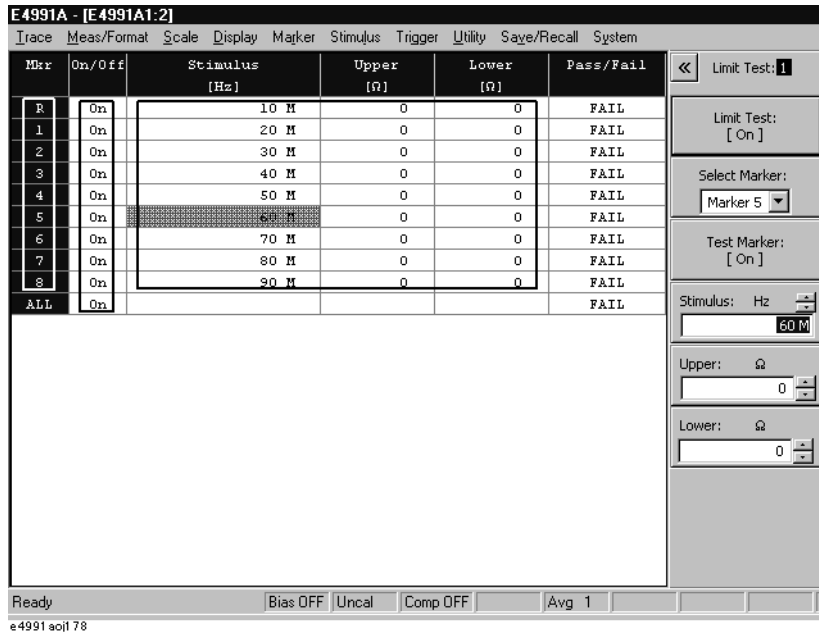
### Setting a Limit to the Trace and Making a Pass/Fail Determination

<b>Limit Marker Setting Box</b>	<b>Setting</b>
<b>Upper</b>	Upper limit of measurement value
<b>Lower</b>	Lower limit of measurement value

g. Set the limit by repeating Steps 1e and 1f while using the necessary number of markers.

**Figure 6-20**

**Clickable Area for Moving Cursor to the Setup Box**



#### Step 2. Execution of Marker Limit Test

The marker limit test is preset to the “on” state, so the test result (**PASS** or **FAIL**) is displayed in the lower-right area of the graph each time a sweep finishes at the completion of Step 1.

#### NOTE

Even after setting the limit, you can click the **Limit Test** button to freely toggle the ON-OFF function of the marker limit test.

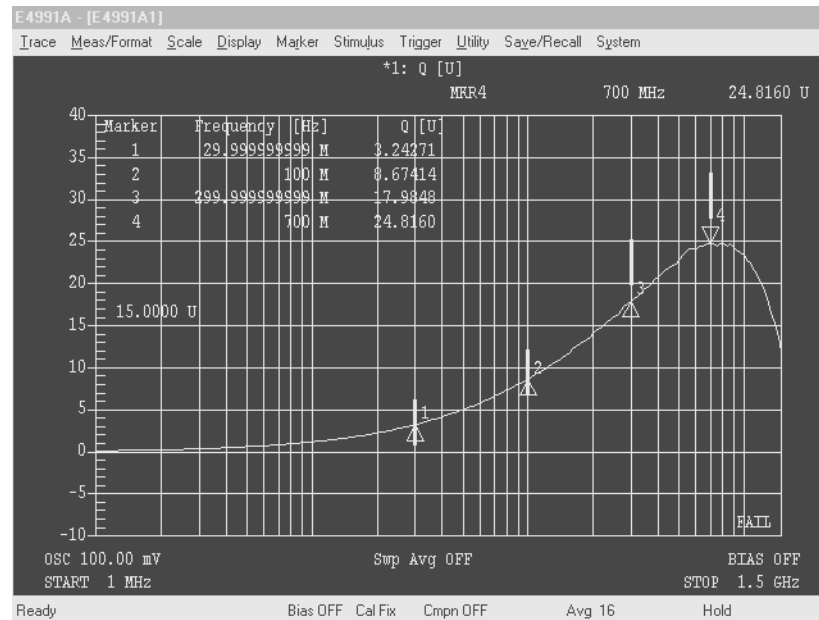
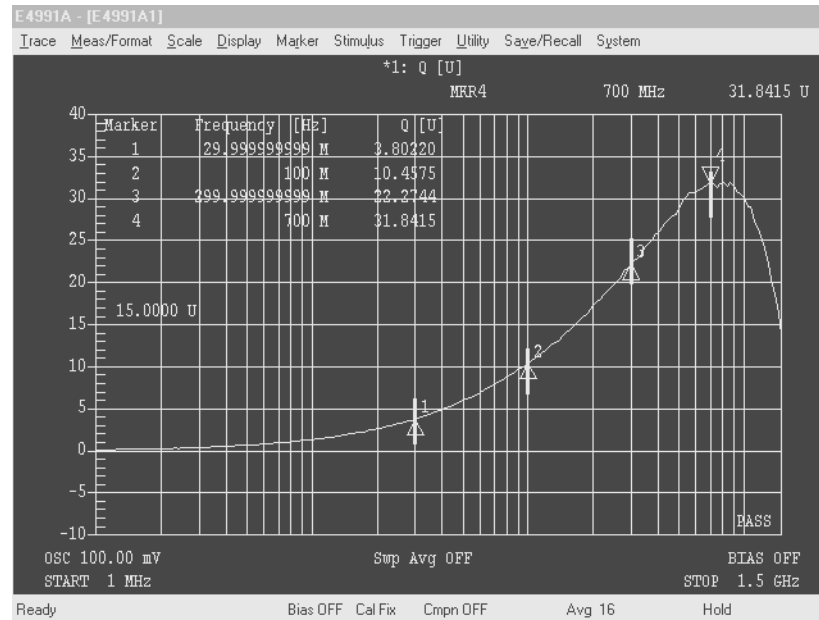
When this function is on, a line showing the limit area appears on the display.



Analysis of Measurement Results  
 Setting a Limit to the Trace and Making a Pass/Fail Determination

Figure 6-21

Example of Marker Limit Test (marker list display “ON”)



Analysis of Measurement Results  
**Setting a Limit to the Trace and Making a Pass/Fail Determination**

---

7

## Saving and Recalling Internal Data

This chapter explains how to save and recall the E4991A's internal data, which includes setting states, measurement data, and graphic images.

## Overview of Save and Recall Functions

The E4991A has save and recall functions to save its internal data in storage devices, such as hard disks or floppy disks, and to recall the data for later use. Table 7-1 shows the save types and their functions. Table 7-2 shows the internal data saved with each save type.

**Table 7-1** Save Types and Their Function

Save Type		Function
Type	File format (Extension)	
Save State	Binary (.sta)	Saves E4991A's setting states, calibration/compensation data, and measurement data. This data is later recalled by the E4991A to set the instrument to the same state as when the data was saved.
Save Data	Binary (.dat)	Saves arrays of E4991A internal data. These arrays are later recalled by the E4991A and used in the same way as when they were saved.
	ASCII (.txt)	Saves arrays of E4991A internal data. This data can be imported into spreadsheet software on a PC.
	CITIfile (.txt)	Converts E4991A measurement data into S parameter data for a specified circuit model. This data can be imported into design support software for design work.
Save Graphics	BMP (.bmp)	Saves E4991A graphic images. This data can be imported into image processing software on a PC.
	JPG (.jpg)	Saves E4991A graphic images. This data can be imported into image processing software on a PC.

**Table 7-2 Save Types and Saved Internal Data (√: Always saved; on/off: Can be switched.)**

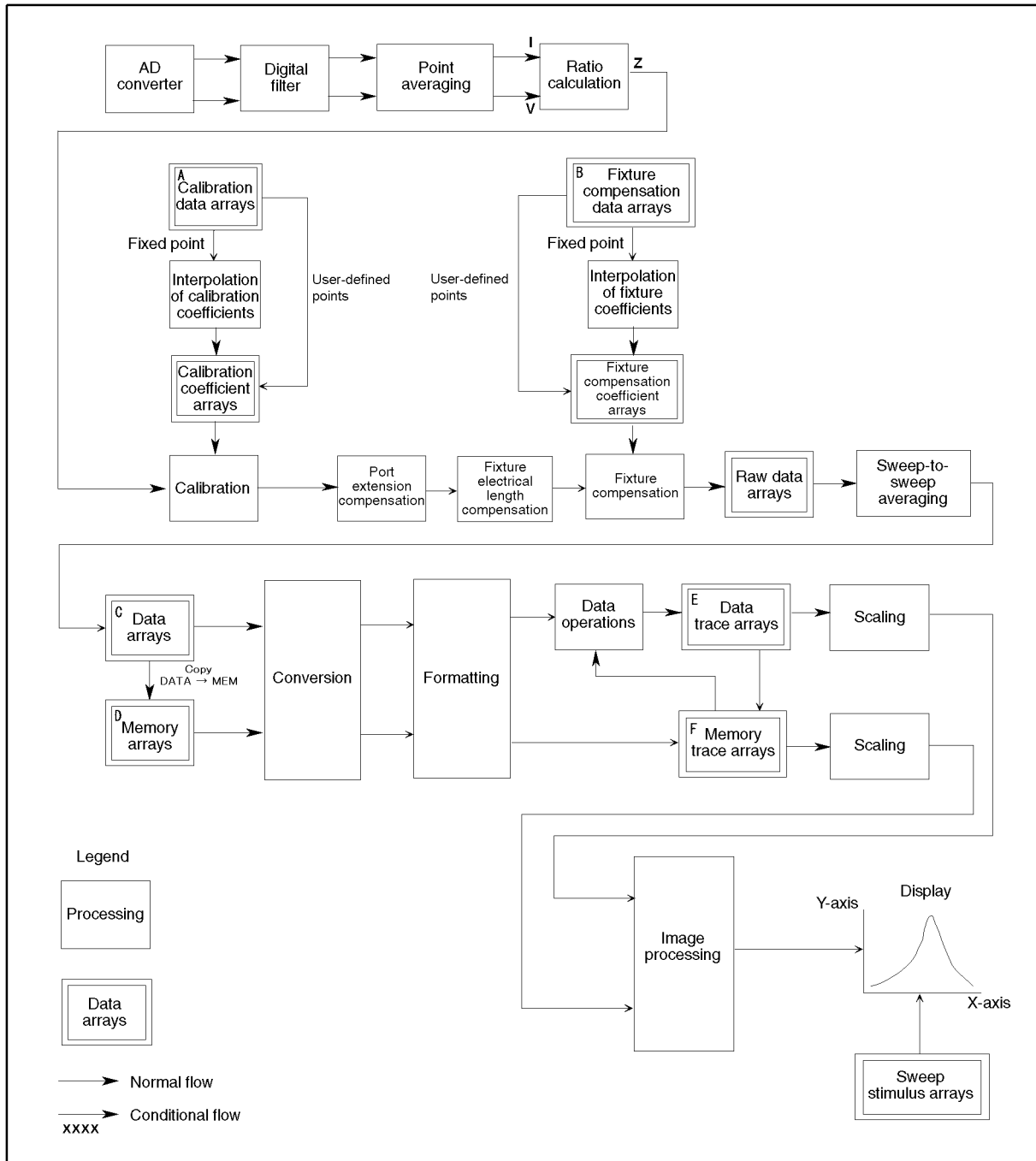
E4991A Internal Data		Save State	Save Data		Save Graphics (BMP/JPG)
			Binary/ASCII format	CITIfile format	
Setting States	All setting states* <sup>1</sup>	√			
Calibration and Compensation Data	Calibration data arrays (see <b>A in Figure 7-1</b> )	√			
	Fixture compensation data arrays (See <b>B in Figure 7-1</b> )	√			
Measurement Data	Data arrays (see <b>C in Figure 7-1</b> )	√	on/off		
	Memory arrays (see <b>D in Figure 7-1</b> )	√	on/off		
	Data trace arrays (see <b>E in Figure 7-1</b> )	√	on/off		
	Data trace arrays (see <b>F in Figure 7-1</b> )	√	on/off		
Converted Data	S parameter, into which measurement data was converted for a specified circuit model			√	
Graphics	Screen data				√

\*1. There are some exceptions. For more details, refer to Appendix G on page 439.

Figure 7-1 shows the E4991A's internal data flow.

Saving and Recalling Internal Data  
**Overview of Save and Recall Functions**

**Figure 7-1 E4991A Internal Data Flow**



e4991a0e121

## Saving and Recalling Setting States (Save State)

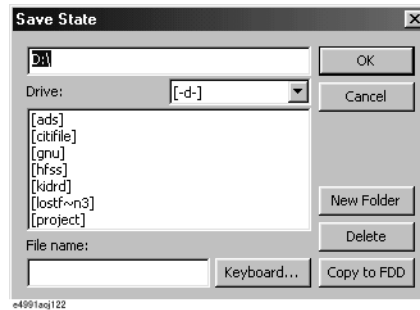
The “Save State” is used to save the E4991A’s setting states, calibration/compensation data, and measurement data (see Table 7-2) into storage devices, such as hard disks and floppy disks, and to recall the data for setting up the E4991A. It is impossible for software other than that of the E4991A to read this data since it is saved in binary format.

### To save setting states:

- Step 1.** Set up the E4991A in the state you want to save.
- Step 2.** Right-click to open the shortcut menu and select **Save/Recall**. Alternatively, you can just press **Save/Recall**.
- Step 3.** Click the **Save State** button to open the **Save State** dialog box (see Figure 7-2).

**Figure 7-2**

**Save State Dialog Box**



- Step 4.** If you want to save the data to a floppy disk, insert the disk into the floppy disk drive.

**NOTE**

If you use the E4991A built-in floppy disk drive, use a 1.44 MB floppy disk in the DOS format.

- Step 5.** The current directory, including the drive name, is displayed in the top box. As shown in Table 7-3, navigate to the drive and directory where you want to save the file.

**Table 7-3**

**Operations in Save/Recall Dialog Box**

Operation	Procedure
Select a drive	Click to open the <b>Drive</b> drop-down list and select the desired storage device.
Move to a lower directory	In the <b>Directory/File list</b> box, double-click the desired directory enclosed by [ ] brackets.
Move to an upper directory	In the <b>Directory/File list</b> box, double-click [..].
Create a new directory under the current directory	In the <b>File name</b> box, type a new directory name and click the <b>New Folder</b> button. Alternatively, if you want to use the mouse to enter the directory name, use the <i>Keyboard</i> dialog box displayed when you click the <b>Keyboard...</b> button.

**Table 7-3**                      **Operations in Save/Recall Dialog Box**

Operation	Procedure
Delete a directory or file	In the <b>Directory/File list</b> box, click to select a directory or a file (the selected one is shown in reversed text) and then click the <b>Delete</b> button.
Copy the existing file to floppy disk	In the <b>Directory/File list</b> box, click to select a directory or a file (the selected one is shown in reversed text) and then click the <b>Copy to FDD</b> button.

**Step 6.** In the **File name** box, type the name of the file you want to save. If you want to use the mouse to enter the file name, use the **Keyboard** dialog box displayed when you click the **Keyboard...** button.

**NOTE**                                      When you type the file name, you do not have to type a file extension. The extension “.sta” is automatically appended, indicating the file contains setting states.

**By naming this directory and file name “d\autorec.sta” when saving setting states, the file will be read automatically and used for setting up the instrument when it is turned on.**

If you want to overwrite a previously saved file, click to select the desired file in the Directory/File list box (the selected one is shown in reversed text). The selected file name is then displayed in the **File name** box.

**Step 7.** Click **OK** to save the data.

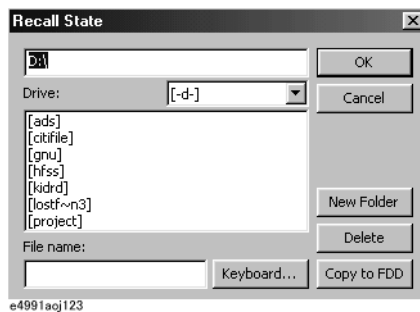
**NOTE**                                      To cancel saving and close the dialog box, click the **Cancel** button or the **X** button instead of **OK**.

**To recall setting states:**

**Step 1.** Right-click to open the shortcut menu and select **Save/Recall**. Alternatively, you can just press **[Save/Recall]**.

**Step 2.** Click the **Recall State** button to open the **Recall State** dialog box (see Figure 7-3).

**Figure 7-3**                      **Recall State Dialog Box**



**Step 3.** When you recall the saved states from a floppy disk, insert the disk into the floppy disk drive.



**Step 4.** The current directory, including the drive name, is displayed in the top box. As shown in Table 7-3 on page 169, navigate to the directory where the file containing the states you want to recall resides.

**Step 5.** In the Directory/File list box, click to select the desired file. The selected one is displayed in reversed text.

---

**NOTE** A status file has the extension “.sta”.

---

**Step 6.** Click **OK** to recall the data.

---

**NOTE** To cancel recalling and close the dialog box, click the **Cancel** button or the **X** button instead of **OK**.

---

## Saving and Recalling Measurement Data in Binary Format

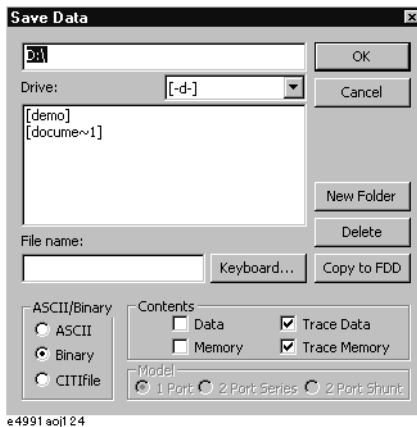
If you want to save measurement data for later recall and use by the E4991A, you must save it in binary format.

### To save measurement data in binary format:

- Step 1.** Perform the measurement for which you want to save data.
- Step 2.** Right-click to open the shortcut menu and select **Save/Recall**. Alternatively, you can just press **Save/Recall**.
- Step 3.** Click the **Save Data** button to open the **Save Data** dialog box (see Figure 7-4).

Figure 7-4

Save Data Dialog Box



- Step 4.** Select the **Binary** option button in the **ASCII/Binary** section.
- Step 5.** Click the check box(es) next to the type(s) of array(s) in the **Contents** section to choose the data you want to save.

Check Box in Contents section	Type of Internal Array
<b>Data</b>	Data arrays (see C in Figure 7-1)
<b>Memory</b>	Memory arrays (see D in Figure 7-1)
<b>Trace Data</b>	Data trace arrays (see E in Figure 7-1)
<b>Trace Memory</b>	Memory trace arrays (see F in Figure 7-1)

- Step 6.** If you want to save the data to a floppy disk, insert the disk into the floppy disk drive.

**NOTE**

If you use the E4991A built-in floppy disk drive, use a 1.44 MB floppy disk in the DOS format.

- Step 7.** The current directory, including the drive name, is displayed in the top box. As shown in Table 7-3 on page 169, navigate to the drive and directory where you want to save the file.

**Step 8.** In the **File name** box, type the name of the file you want to save. If you want to use the mouse to enter the file name, use the **Keyboard** dialog box displayed when you click the **Keyboard...** button.

---

**NOTE** When you type the file name, you do not have to type a file extension. The extension “.dat” is automatically appended, indicating the file contains measurement data in binary format.

If you want to overwrite a previously saved file, click to select the desired file in the Directory/File list box (the selected one is shown in reversed text). The selected file name is then displayed in the **File name** box.

---

**Step 9.** Click **OK** to save the data.

---

**NOTE** To cancel saving and close the dialog box, click the **Cancel** button or the **X** button instead of **OK**.

---

### To recall measurement data:

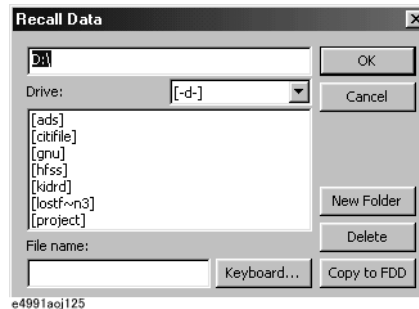
Perform the following procedure to recall measurement data saved to the E4991A in binary format.

**Step 1.** Right-click to open the shortcut menu and select **Save/Recall**. Alternatively, you can just press **Save/Recall**.

**Step 2.** Click the **Recall Data** button to open the **Recall Data** dialog box (see Figure 7-5).

**Figure 7-5**

**Recall Data Dialog Box**



**Step 3.** When you recall the data from a floppy disk, insert the disk into the floppy disk drive.

**Step 4.** The current directory, including the drive name, is displayed in the top box. As shown in Table 7-3 on page 169, navigate to the directory where the file containing the measurement data you want to recall resides.

**Step 5.** In the Directory/File list box, click to select the desired file. The selected file is displayed in the reversed text.

---

**NOTE** A file saved in binary format has the extension “.dat”.

---

**Step 6.** Click **OK** to recall the data.

---

**NOTE** To cancel recalling and close the dialog box, click the **Cancel** button or the **X** button

## Saving and Recalling Internal Data

### Saving and Recalling Measurement Data in Binary Format

\_\_\_\_\_ instead of **OK**.

---

**NOTE**

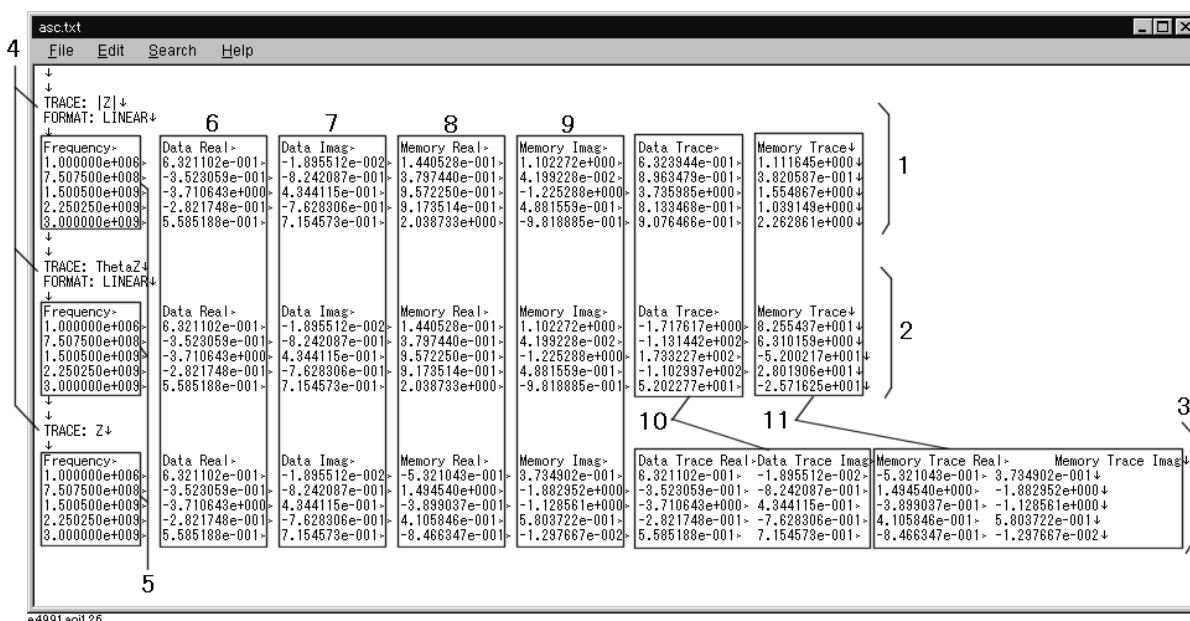
It is impossible to recall the data when the number of points of the saved data is different from the number of points in the E4991A's set-up; in this case, an error occurs.

## Saving Measurement Data to Read in Spreadsheet Software (Saving in ASCII Format)

Measurement data that has been saved in ASCII format can be imported into software on a PC such as Microsoft Notepad™ (a text editor) or Microsoft Excel™ (a spreadsheet application).

Figure 7-6 shows an example of measurement data saved in ASCII format. This data was measured under the conditions shown in the Table 7-4, saved in an ASCII file, and then viewed with a text editor on a PC.

**Figure 7-6** Example of Measurement Data Saved in ASCII Format (using text editor to view data saved under conditions shown in Table 7-4)



↓ in Figure 7-6 indicates a return code, and %o indicates a tab. Numbers 1 to 11 indicate the following:

1. Trace 1 data ( $|Z|$ )
2. Trace 2 data ( $\theta z$ )
3. Trace 4 data ( $Z$ )
4. Measurement parameters for each trace (TRACE:) and axis format (FORMAT:)  
The axis format is displayed only when a measurement parameter is scalar.
5. Sweep parameters and their values
6. Real components of data arrays (see C in Figure 7-1)
7. Imaginary components of data arrays (see C in Figure 7-1)
8. Real components of memory arrays (see D in Figure 7-1)
9. Imaginary components of memory arrays (see D in Figure 7-1)
10. Data trace arrays (see E in Figure 7-1)  
If a measurement parameter represents a complex number, real and imaginary parts are displayed.
11. Memory trace arrays (see F in Figure 7-1)  
If a measurement parameter represents a complex number, real and imaginary parts are

Saving and Recalling Internal Data  
**Saving Measurement Data to Read in Spreadsheet Software (Saving in ASCII Format)**

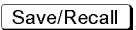
displayed.

**Table 7-4 Measurement Conditions for Saving Data**

Measurement Condition	Value
Number of points	5 (for simplicity, the small number of points is used.)
Number of traces and trace types	2 × scalar traces and 1 × complex trace ( <b>2 Sclr, 1 Complex</b> )
Measurement parameters	Trace 1:  Z , Trace 2: $\theta z$ , Trace 4: Z
Axis Format	Trace 1: <b>Linear Y-Axis (Lin Y-Axis)</b> Trace 2: <b>Linear Y-Axis (Lin Y-Axis)</b>
Define Trace	Trace 1: <b>Data &amp; Memory</b> , Trace 2: <b>Data &amp; Memory</b> , Trace 4: <b>Data &amp; Memory</b>

**NOTE** Data that has been saved in ASCII format cannot be recalled and used by the E4991A. To recall data to the E4991A, save it in binary format. For details, see the section “Saving and Recalling Measurement Data in Binary Format” on page 172.

**To save measurement data in ASCII format:**

- Step 1.** Perform the measurement for which you want to save data.
- Step 2.** Right-click to open the shortcut menu and select **Save/Recall**. Alternatively, you can just press .
- Step 3.** Click the **Save Data** button to open the **Save Data** dialog box (see Figure 7-4).
- Step 4.** Select the **ASCII** option button in the **ASCII/Binary** section.
- Step 5.** Click the check box(es) next to the type(s) of array(s) in the **Contents** section to choose the data you want to save.

Check Box in Contents Section	Type of Internal Array
<b>Data</b>	Data arrays (see C in Figure 7-1)
<b>Memory</b>	Memory arrays (see D in Figure 7-1)
<b>Trace Data</b>	Data trace arrays (see E in Figure 7-1)
<b>Trace Memory</b>	Memory trace arrays (see F in Figure 7-1)

- Step 6.** If you want to save the data to a floppy disk, insert the disk into the floppy disk drive.

**NOTE** If you use the E4991A built-in floppy disk drive, use a 1.44 MB floppy disk in the DOS format.

- Step 7.** The current directory, including the drive name, is displayed in the top box. As shown in Table 7-3 on page 169, navigate to the drive and directory where you want to save the file.
- Step 8.** In the **File name** box, type the name of the file you want to save. If you want to use the

## Saving Measurement Data to Read in Spreadsheet Software (Saving in ASCII Format)

mouse to enter the file name, use the **Keyboard** dialog box displayed when you click the **Keyboard...** button.

---

### NOTE

When you type the file name, you do not have to type a file extension. When the measurement data is saved in ASCII format, the extension “.txt” is automatically appended.

If you want to overwrite a previously saved file, click to select the desired file in the Directory/File list box (the selected one is shown in reversed text). The selected file name is then displayed in the **File name** box.

---

**Step 9.** Click **OK** to save the data.

---

### NOTE

To cancel saving and close the dialog box, click the **Cancel** button or the **X** button instead of **OK**.

---

### To import measurement data saved in ASCII format into Microsoft Excel™:

Measurement data that has been saved in ASCII format can be imported into spreadsheet software on a PC. This section shows an example of importing data into the popular Microsoft Excel 97™ program.

- Step 1.** Start the Microsoft Excel™ application.
- Step 2.** Click **File/Open** on the menu bar.
- Step 3.** In the **Open** dialog box, click to select a **text file (\*.prn, \*.csv, \*.txt)** from the **File Type** dialog box.
- Step 4.** Select the ASCII file (with the extension .txt) containing the E4991A measurement data, and click the **Open** button.
- Step 5.** In the **Text Input Wizard - Step 1 of 3** dialog box that appears, click the **Delimited - Characters Such As Commas or Tabs Separate Fields** option button in the Original Data Type section and then click **Next**.
- Step 6.** In the **Text Input Wizard - Step 2 of 3** dialog box that appears, check the **Tab** check box in the **Delimiter** section and then click **Next**.
- Step 7.** In the **Text Input Wizard - Step 3 of 3** dialog box that appears, click the **General** option button of the **Column Data Format** section and then click **Finish**.

Figure 7-7 shows an example of ASCII data imported into Excel™.

Figure 7-8 shows an example of a data trace graph generated by one of the Excel™ chart functions (scatter diagram). This graph’s source data is different from the data shown in Figure 7-7.

Saving and Recalling Internal Data  
**Saving Measurement Data to Read in Spreadsheet Software (Saving in ASCII Format)**

Figure 7-7 Example of ASCII Measurement Data File Imported into Excel™

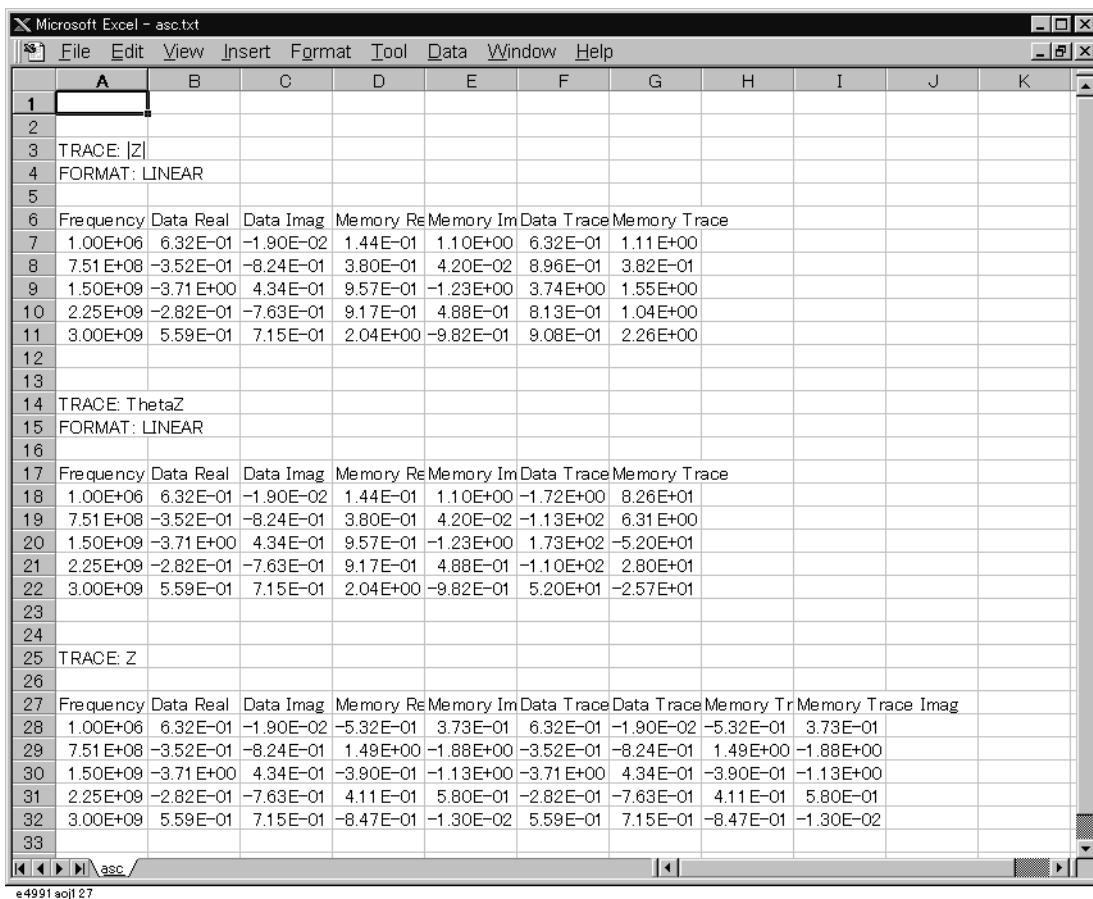
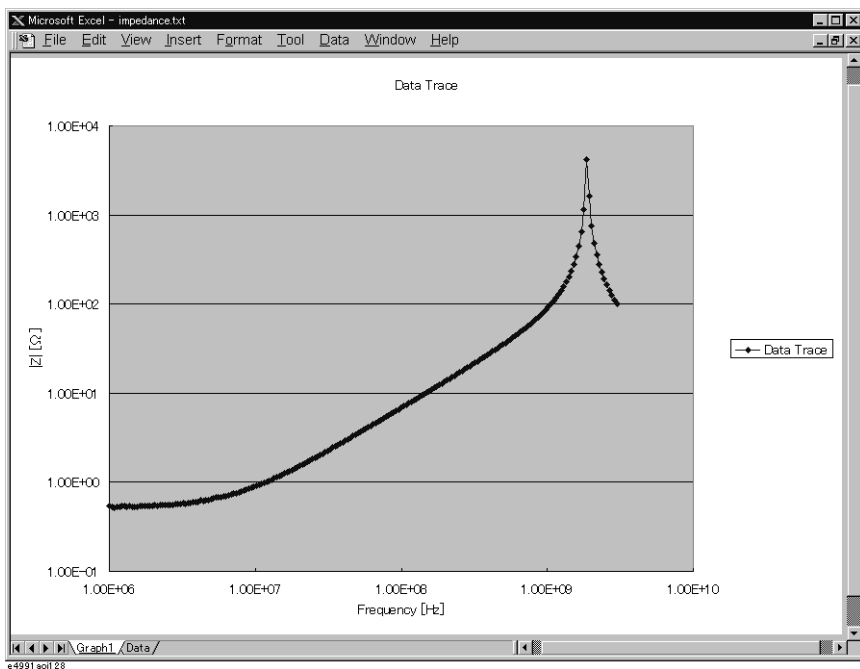


Figure 7-8 Example of Data Trace Graph Generated by Excel™ chart function (scatter diagram)





## Saving Measurement Data in CITIfile Format

### Overview of CITIfile Data Format

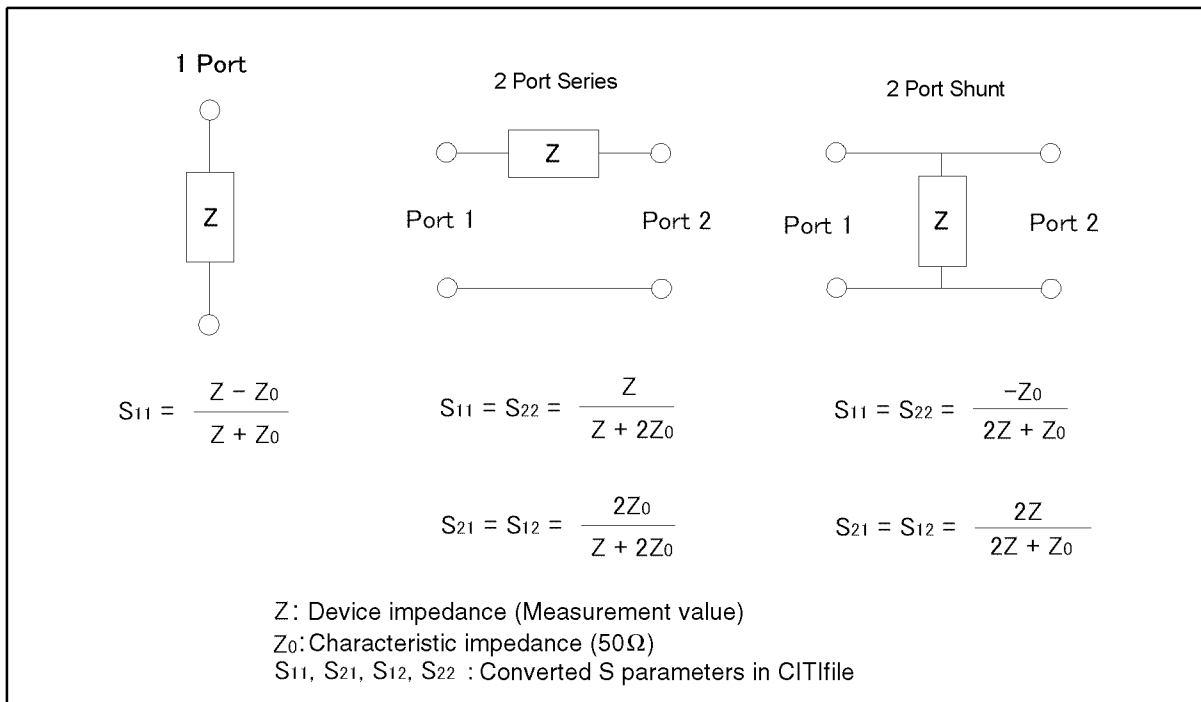
A Common Instrumentation Transfer and Interchange file (CITIfile) uses a standard data format for exchanging data between a computer and an instrument. A CITIfile has some predefined rules for the data it contains. However, a CITIfile can be saved in any disk format (DOS, HFS, etc.), transferred by any method (via disk, LAN, GPIB, etc.), and reside under any operating system (DOS, UNIX, etc.) since its data format is ASCII.

Any other instrument or computer can read a CITIfile created strictly in accord with the predefined rules. For example, measurement data from an impedance analyzer can be imported into Agilent's Microwave Design System (MDS) and Advanced Design System (ADS), among others, for simulation.

### How to Create a CITIfile on the E4991A

When a CITIfile is created on the E4991A, impedance measurement data (see C of Figure 7-1) is converted into S parameters for a specified device model. Figure 7-9 shows device models and conversion expressions.

**Figure 7-9** Creation of CITIfile on E4991A (circuit models and conversion expressions)



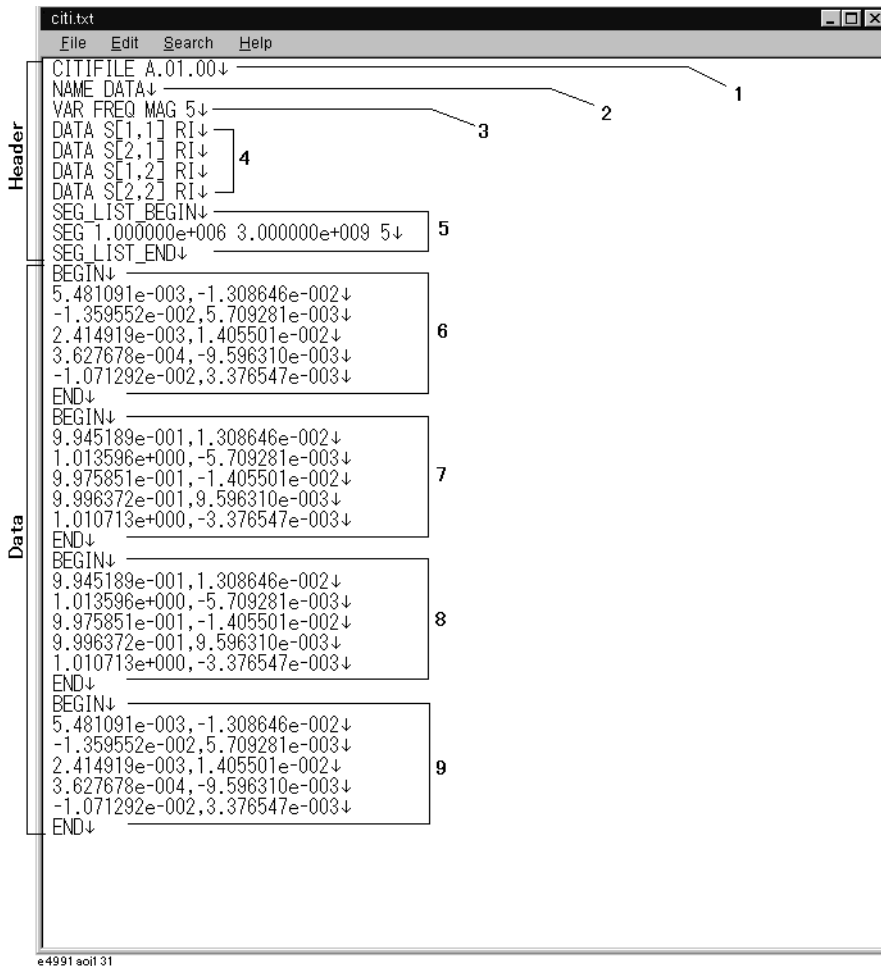
e4991a0e130

## CITIfile Structure

Figure 7-10 shows an example of a CITIfile actually created and saved by the E4991A.

Figure 7-10

Example of CITIfile Saved by E4991A



↓ in Figure 7-10 indicates a return code.

A CITIfile consists of the Header and Data sections. The Header section contains status information and the Data section contains array data. Numbers 1-9 in Figure 7-10 indicate the following:

1. The keyword CITIFILE is always included at the top of this type of file to indicate that it is a CITIfile. Following this keyword is a version number (A.01.00 in this case).
2. Following the keyword NAME is the name of the CITIfile package. A CITIfile generated by the E4991A always has the name DATA.
3. Following the keyword VAR is the information on variables. FREQ indicates frequency, MAG amplitude format, and 5 the number of measurement points.
4. Following the keyword DATA are a data array name and a format, the details of which are described in the DATA section in the latter part of this CITIfile package. S[1,1], S[2,1], S[1,2], and S[2,2] represent the four S parameters  $S_{11}$ ,  $S_{21}$ ,  $S_{12}$ , and  $S_{22}$ , respectively. RI indicates that the data is described in the R1 format, which consists of real and imaginary parts.
5. Between the keywords SEG\_LIST\_BEGIN and SEG\_LIST\_END are segment lists.

- Following the keyword SEG are start frequency (1 MHz in this case), stop frequency (3GHz in this case) and the number of measurement points (5 points in this case).
6. Between the keywords BEGIN and END are array data ( $S_{11}$ ) shown in 4. The real and imaginary parts are delimited with a comma.
  7. Between the keywords BEGIN and END are array data ( $S_{21}$ ) shown in 4. The real and imaginary parts are delimited with a comma.
  8. Between the keywords BEGIN and END are array data ( $S_{12}$ ) shown in 4. The real and imaginary parts are delimited with a comma.
  9. Between the keywords BEGIN and END are array data ( $S_{22}$ ) shown in 4. The real and imaginary parts are delimited with a comma.

**To create a CITIfile:**

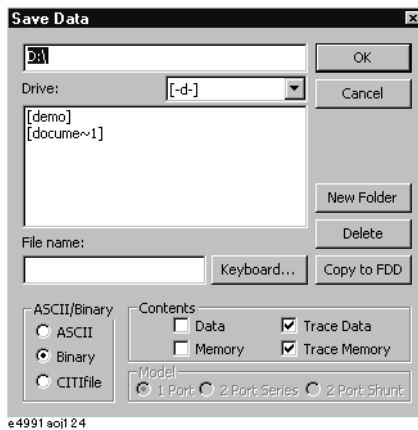
- Step 1.** Perform impedance measurement of a component under test while the instrument is set to the desired measurement conditions.

**NOTE** Before measurement, perform necessary calibration and compensation.

- Step 2.** Right-click to open the shortcut menu and select **Save/Recall**. Alternatively, you can just press **Save/Recall**.
- Step 3.** Click the **Save Data** button to open the **Save Data** dialog box (see Figure 7-11).

**Figure 7-11**

**Save Data Dialog Box**



- Step 4.** Click the **CITIfile** option button in the **ASCII/Binary** section.
- Step 5.** Click the option button next to the desired circuit model in the **Model** section.

Option Buttons in Model Section	Circuit Model
<b>1 port</b>	1-port model (see 1 port in Figure 7-9)
<b>2-port Series</b>	2-port series model (see 2-port series in Figure 7-9)
<b>2-port Shunt</b>	2-port shunt model (see 2-port shunt in Figure 7-9)

## Saving and Recalling Internal Data

### Saving Measurement Data in CITIfile Format

**Step 6.** If you want to save the data to a floppy disk, insert the disk into the floppy disk drive.

---

**NOTE** If you use the E4991A built-in floppy disk drive, use a 1.44 MB floppy disk in the DOS format.

---

**Step 7.** The current directory, including the drive name, is displayed in the top box. As shown in Table 7-3 on page 169, navigate to the drive and directory where you want to save the file.

**Step 8.** In the **File name** box, type the name of the file you want to save. If you want to use the mouse to enter the file name, use the **Keyboard** dialog box displayed when you click the **Keyboard...** button.

---

**NOTE** When you type the file name, you do not have to type a file extension. The extension “.txt” is automatically appended, indicating that the file is saved in ASCII format.

If you want to overwrite a previously saved file, click to select the desired file in the Directory/File list box (the selected one is shown in reversed text). The selected file name is displayed in the **File name** box.

---

**Step 9.** Click **OK** to save the data.

---

**NOTE** To cancel saving and close the dialog box, click the **Cancel** button or the **X** button instead of **OK**.

---

## Saving Display Information (Save Graphics)

Graphic images on the E4991A LCD display that have been saved in a file in BMP (Windows or OS/2 Bitmap) or JPG (JPEG) format can be imported and used by image processing software.

### To save display information:

- Step 1.** Display the graphic images you want to save.
- Step 2.** Right-click to open the shortcut menu and select **Save/Recall**. Alternatively, you can just press **Save/Recall**.
- Step 3.** Click the **Save Graphics** button to open the **Save Graphics** dialog box (see Figure 7-12).

**Figure 7-12**



- Step 4.** Click the option button next to the desired file format of the **Format** section.

Option Buttons in Format Section	Saved File Format
<b>Jpeg</b>	JPEG format
<b>BMP</b>	Windows or OS/2 Bitmap format

- Step 5.** If you want to save the data to a floppy disk, insert the disk into the floppy disk drive.

**NOTE**

If you use the E4991A built-in floppy disk drive, use a 1.44 MB floppy disk in the DOS format.

- Step 6.** The current directory, including the drive name, is displayed in the top box. As shown in Table 7-3 on page 169, navigate to the drive and directory where you want to save the file.
- Step 7.** In the **File name** box, type the name of the file you want to save. If you want to use the mouse to enter the file name, use the **Keyboard** dialog box displayed when you click the **Keyboard...** button.

## Saving and Recalling Internal Data

### Saving Display Information (Save Graphics)

---

**NOTE** When you type the file name, you do not have to type a file extension. The extension “.bmp” or “.jpg” is automatically appended, depending on the format selected in Step 4.

If you want to overwrite a previously saved file, click to select the desired file in the Directory/File list box (the selected one is shown in reversed text). The selected file name is displayed in the **File name** box.

---

**Step 8.** Click **OK** to save the data.

---

**NOTE** To cancel saving and close the dialog box, click the **Cancel** button or the **X** button instead of **OK**.

---

---

**NOTE** The graphic image is saved at the moment of clicking the **OK** button. The displayed setup toolbar is not included in the saved image.

---

### Recalling Saved Image File

An image file that has been saved in the .bmp or .jpg format can be imported into image processing software. For details on how to import an image file, refer to the manual of the application you are using.

---

## 8 Printing Measurement Results and Internal Data

This chapter explains how to print a measurement graph or an internal data list shown on the instrument's display with a printer attached to the E4991A.

## Printing Measurement Graphs and Internal Data Lists

To print measurement result graphs, measurement value lists (Figure 8-1), and measurement condition (operating parameter) lists (Figure 8-2), attach your printer to the printer parallel port (“3. Printer parallel port (PRINTER, Parallel)” on page 29), or the rear USB port (“11. Rear USB port” on page 30) on the rear panel of the E4991A.

**Figure 8-1** Example Printout of Measurement Value List (number of measurements: 5)

No.	Frequency [Hz]	Z [ $\Omega$ ]	$\theta z$ [ $^{\circ}$ ]
1	1 M	9.93270	-130.127
2	750.75 M	9.29911	146.346
3	1.5005 G	42.4958	95.8164
4	2.25025 G	181.623	85.2015
5	3 G	27.0127	-45.9005

e4991a0j143

**Figure 8-2** Example Printout of Measurement Condition (Operating Parameter) List

[SWEEP]	
Sweep Source	Frequency
Sweep Type	Linear
Number of Points	5
Point Average	1
[SOURCE]	
Osc Level	100.00 mV
Osc Unit	Voltage
CW Frequency(Hz)	1 M
Bias Mode	OFF
Bias Source	Current
Bias Level	100 $\mu$ A
Bias Limit	1 V
[TRIG]	
Event	Sweep
Source	Internal
Polarity	Positive
[CAL/COMPEN]	
Type	Fixed,Full Range
-Calibration-	
Open	ON
Short	ON
Load	ON
Low Loss C	ON
-Compensation-	
Open	ON
Short	ON

e4991a0j142



## Supported Printers

Table 8-1 shows the printers that can be attached to the E4991A, printer driver used, and corresponding port on the E4991A.

For the latest information of the supported printers for the E4991A, contact Agilent Technologies. When contacting us, see the list of our customer centers at the end of this manual.

**Table 8-1 Printers for Use with E4991A (as of April 2001)**

Printer Maker	Model Name	Printer Driver <sup>*1</sup>	Port
Hewlett-Packard	DeskJet 930C Series	HP DeskJet 550C	Printer parallel port
	DeskJet 895C Series (895Cse, 895Cxi)		
	DeskJet 970C Series (970Cse, 970Cxi)		

\*1. The drivers for all supported printers at the time of shipment are installed in the E4991A.

### NOTE

If you want to use a printer that Agilent has announced support for other than those listed in Table 8-1, you must first install the appropriate printer driver software on the E4991A. For details on how to install a printer driver, see “Installing Printer Drivers” on page 191.

Only the printers, printer drivers, and ports used for the local user interface (Table 8-1) can be used for the E4991A remote user interface software on an external PC. For details on the remote user interface, see “Using Remote User Interface” on page 228.

## How to print data on the screen

### NOTE

When the **Add New Hardware Wizard** (Figure 8-3) dialog box pops up, you must press **Cancel** to quit the wizard.

**Figure 8-3**

### Add New Hardware Wizard



**Step 1.** Prepare your printer.

Printing Measurement Results and Internal Data  
**Printing Measurement Graphs and Internal Data Lists**

- a. Attached your printer to the printer parallel port (see “3. Printer parallel port (PRINTER, Parallel)” on page 29) on the rear panel of the E4991A.

For details on how to attach a printer to the port, see the appropriate instructions in your printer’s manual.

**NOTE** Do not attach a printer until you have installed the corresponding driver on the E4991A.

- b. Turn on your printer’s power.

**Step 2.** To print a measurement graph, click inside the window of the desired trace (or press **Trace**) to make its window active. The selected window’s frame will be red.

**Step 3.** Right-click to open the shortcut menu and select **Display**, or just press **Display**.

**Step 4.** Click the **Print/Clipbd Menu** button.

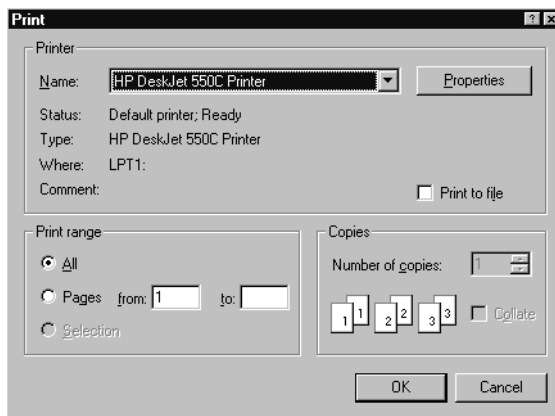
**Step 5.** Click to select the desired print operation button.

Print operation button	Function
<b>Print Graph (Color)</b>	Prints the graph in the active window in color.
<b>Print Graph (Mono)</b>	Prints the graph in the active window in black and white.
<b>Printer List Values</b>	Prints a list of measurement values (Figure 8-1).
<b>Print Operating Params</b>	Prints a list of operating parameters (measurement conditions) (Figure 8-2).

After clicking one of the above buttons, the **Print** dialog box (Figure 8-4) opens.

**Figure 8-4**

**Print Dialog Box**



**Step 6.** Confirm that **HP DeskJet 550C Printer** is selected in the **Name** box of the **Printer** section.

Selection in Name drop-down list	Printer
<b>HP DeskJet 550C Printer</b>	HP DeskJet 930C Series (Attached to printer parallel port)

Selection in Name drop-down list	Printer
	HP DeskJet 895C Series (Attached to printer parallel port)
	HP DeskJet 970C Series (Attached to printer parallel port)

**NOTE** If you use a printer driver installed in accordance with “Installing Printer Drivers” on page 191, click the **Name** drop-down menu to select your printer’s name.

**Step 7.** Perform print setting, as discussed in Table 8-2.

**Table 8-2 Options in Print Dialog Box**

Option	How to set
Printer properties and Print to file	Click the <b>Properties</b> button in the <b>Printer</b> section to display the printer driver’s property dialog box (Figure 8-5), where you can set up printing options such as portrait or landscape print orientation. You can create a printer file (.prn) instead of outputting to your printer by checking the <b>Print to file</b> check box (✓) in the <b>Printer</b> section.
Print range	If the print range covers more than two pages, click to select the <b>All</b> (print all pages) or <b>Pages</b> (print specified pages) radio button in the <b>Print range</b> section. When you select the <b>Pages</b> radio button, enter the start and end pages in the <b>from</b> and <b>to</b> boxes, respectively <sup>*1</sup> .
Number of copies <sup>*2</sup>	Enter the number of copies you want to print in the <b>Number of copies</b> box in the <b>Copies</b> section <sup>*3</sup> .
Collate <sup>*2</sup>	To make collated sets of copies, check the <b>Collate</b> check box in the <b>Copies</b> section.

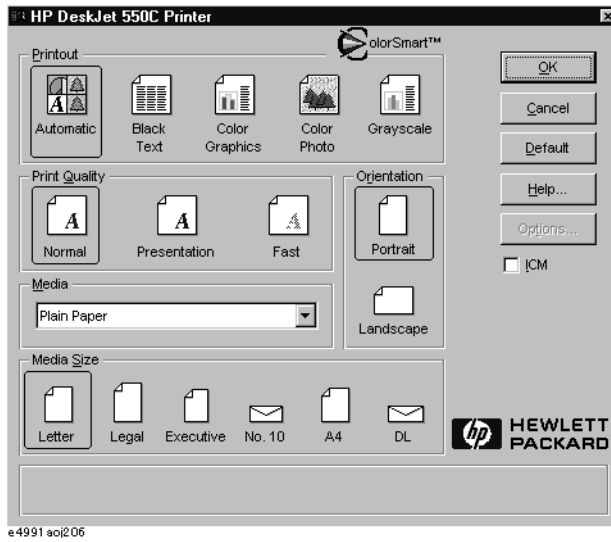
<sup>\*1</sup>. Use the front panel key or the keyboard to type the number.

<sup>\*2</sup>. Some printers do not support this function.

<sup>\*3</sup>. Use the front panel key or the keyboard to type the number, or use the st buttons to the right of the spin box to select the desired number.

Figure 8-5

Properties Dialog Box for HP DeskJet 550C Printer Driver



Step 8. Click **OK** to start printing.

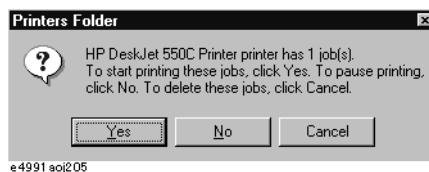
**NOTE**

To close the dialog box without printing, click the **Cancel** or **X** button instead of **OK**.

The Printer Folder dialog box (Figure 8-6) may pop up after turning on the E4991A if the instrument has print data. On the external keyboard, press and hold down **Alt** and then press **Tab** to again display the Printers Folder dialog box (Figure 8-6) and then click **Cancel** to delete the internal data.

Figure 8-6

Printers Folder Dialog Box



## Installing Printer Drivers

If you want to use a different type of printer that Agilent has announced support for, perform the following procedure to install the corresponding printer driver in the E4991A.

### How to install a printer driver:

#### NOTE

**Agilent Technologies does not support the use of any printer or printer driver that is not officially approved for use by Agilent Technologies.**

You must not physically attach the driver's printer until you have completed Step 2.

**Be sure to install the printer driver's American English version that can run under Windows 2000™.**

The printer driver can be installed from a 3.5 inch floppy disk or through the LAN port of the E4991A. When you install the printer driver via LAN, you need to connect an external computer to the E4991A's FTP server, transfer the driver file to the hard disk drive of the E4991A, and access the driver file to install the driver; alternatively, you can connect an external hard disk drive to the E4991A via LAN and remotely access the driver file to install the driver. You must complete the LAN settings of the E4991A before you can install a printer driver via LAN. For more details about setting up and using a LAN, refer to "Configuring the Network" on page 216.

Use the mouse or keyboard to perform the following procedure.

#### Step 1. Obtain the printer driver.

Obtain the English version of the printer driver that can run under Window 2000. In most cases, a printer driver can be downloaded from the Web site of the printer's manufacturer.

When you install the printer driver from a floppy disk, copy the downloaded printer driver file(s) into 3.5 inch floppy disks. When you install it over LAN, transfer the driver file into the hard disk drive of the E4991A using the FTP function or move it to a hard disk drive connected to the E4991A via LAN.

#### NOTE

When copying a printer driver to floppy disks, the file is typically divided into about three disks. Therefore, if you download a printer driver from a Web site, you must specify that the driver be divided into several files so that you can copy each file to a floppy disk.

#### Step 2. Exit the E4991A system program.

- a. Select **System - Exit** from the menu bar. This opens the **Enter Password to exit** dialog box (see Figure 8-7).

Figure 8-7

#### Enter Password to exit Dialog Box



- b. Use the character entry dialog box that appears when you click the **Keyboard...** button

## Printing Measurement Results and Internal Data Installing Printer Drivers

or your keyboard to type the password, **e4991a**, in the **Password** box.

- c. Click **OK** to exit the E4991A system.

### Step 3. Turn on the printer's power and attach it to the E4991A.

### Step 4. Install the printer driver.

Install the printer driver in the E4991A just as you would do in a computer running Windows 2000™. For details, see the installation procedure included with the printer driver.

### Step 5. Shutdown the E4991A and then restart it.

- a. Move the mouse pointer to the lower left part of the E4991A screen and click **Start - Shut Down...**
- b. Click to select **Shut down** and choose **OK**.
- c. After the E4991A's power is turned off, press and immediately release the Standby switch (see "1. Standby switch" on page 23) and then press the switch again to turn the power on.

---

**9**

## **Setup and Use of Control/Management Functions**

This chapter describes the setup and use of the E4991A Control/Management functions that are not directly related to measuring and analyzing DUTs.

## Setting the GPIB

This section describes how to set the interface necessary to use the GPIB (General Purpose Interface Bus) of the E4991A. For information on the concept and concrete implementation of the auto measurement using GPIB, refer to “Programmers Guide.”

### Setting talker/listener GPIB address of E4991A

When controlling the E4991A using GPIB commands from the external controller connected to the GPIB connector, you need to set the talker/listener GPIB address of the E4991A.

Follow these steps to make this setting:

- Step 1.** Open the shortcut menu by right-clicking and select System (Or press [System] ).
- Step 2.** Click the GPIB Setup Menu button
- Step 3.** Open the E4991A Address box by clicking it, and then select a new address by clicking one.

### Setting system controller (USB/GPIB interface)

When controlling an external device from the E4991A, connect the USB port of the E4991A and the GPIB port of the external device through the USB/GPIB interface.

Follow these steps to set the USB/GPIB interface:

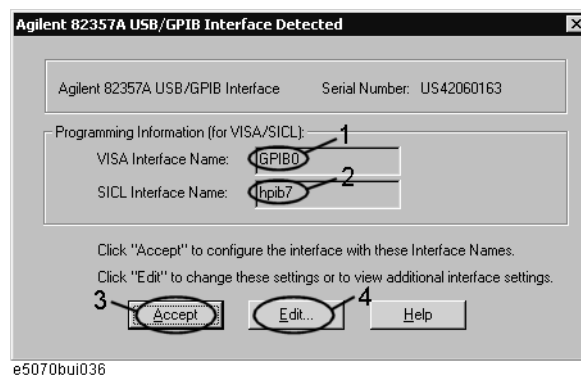
- Step 1.** Connect the USB port of the E4991A to the USB/GPIB interface. The USB/GPIB Interface Detected dialog box (Figure 9-1) appears.

#### NOTE

Do not connect two or more USB/GPIB interfaces.

Figure 9-1

USB/GPIB Interface Detected dialog box



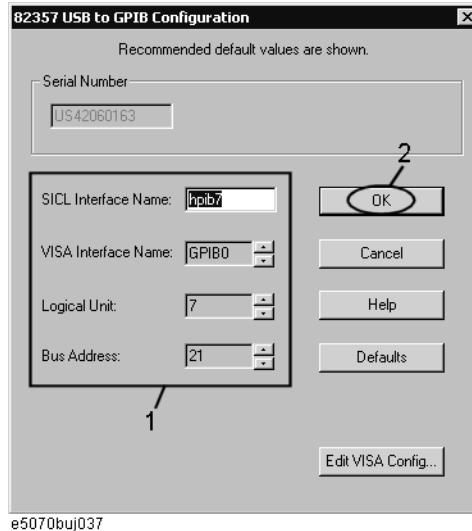
- Step 2.** Confirm that VISA Interface Name is set to GPIB0 (1 in Figure 9-1) and SICL Interface Name is set to hpib7 (2 in Figure 9-1) and then click the **Accept** button (3 in Figure 9-1). If the setting is correct, the procedure is complete. If the setting is different, click the **Edit** button (4 in Figure 9-1).



- Step 3.** The USB to GPIB Configuration dialog box (Figure 9-2) appears. Make the setting enclosed in the thick lines in Figure 9-2 (1 in Figure 9-2) according to the figure and then click the **OK** button (2 in Figure 9-2).

Figure 9-2

USB to GPIB Configuration dialog box



If you need to check/change the setting of the USB/GPIB interface after connecting the USB/GPIB interface, follow these steps:

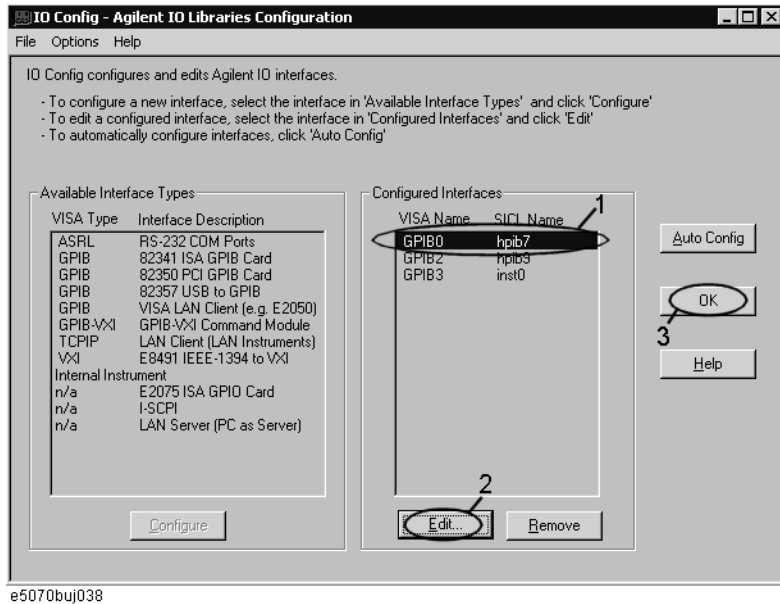
- Step 1.** Open the shortcut menu by right-clicking and select System (Or press [System] ).
- Step 2.** Click the GPIB Setup Menu button.
- Step 3.** Press **System Controller Configuration**.
- Step 4.** The IO Config dialog box (Figure 9-3) appears. Select (highlight) **GPIB0 hpib7** (1 in Figure 9-3) and then click the **Edit** button (2 in Figure 9-3).

**NOTE**

In the IO Config dialog box, do not click buttons other than specified here or do not change other settings because doing so may cause serious damage to the functions of the E4991A.

Figure 9-3

IO Config dialog box



**Step 5.** The USB to GPIB Configuration dialog box (Figure 9-2) appears. Check/change the setting of the USB/GPIB interface and then click the **OK** button (2 in Figure 9-2).

**Step 6.** In the USB to GPIB Configuration dialog box, click the **OK** button (3 in Figure 9-3).

## Setting the Internal Clock

The E4991A has a built-in clock for the date and time. This internal clock is used for recording the date and time of when internal data or a VBA program is saved as a file.

### Procedure for setting the internal clock

**NOTE** Use the mouse or keyboard for the following operation.

#### Step 1. Exiting the E4991A system program.

- a. Click **System - Exit** in the menu bar.

The **Enter Password to exit** dialog box (Figure 9-4) opens.

Figure 9-4

#### Enter Password to exit dialog box



- b. Click the **Keyboard...** button and use the displayed character entry dialog box or use an external keyboard to enter the password **e4991a** in the **Password** box.
- c. Click the **OK** button to exit the E4991A system.

#### Step 2. Setting the date and time.

- a. Click the **Start** button in the lower-left corner of the screen and select **Settings - Control Panel** (Figure 9-5). This operation will open the **Control Panel** window (Figure 9-6).

Figure 9-5

#### Select Control Panel from the start menu.

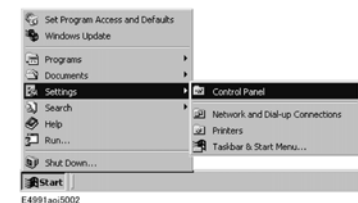


Figure 9-6

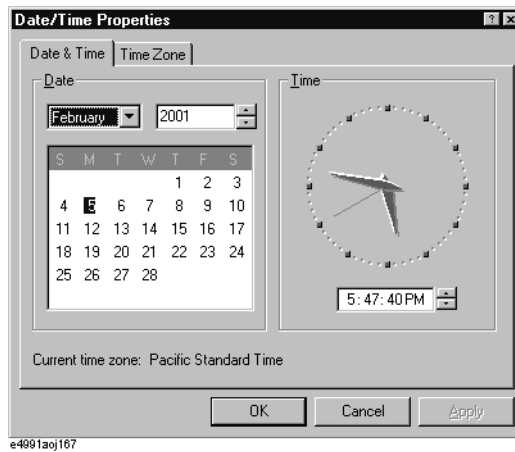
Control Panel window



- b. After double-clicking the **Date/Time** icon, the Date/Time Properties dialog box (Figure 9-7) will open.

Figure 9-7

Date/Time Properties dialog box



- c. Set the date and time in the **Date** and **Time** areas, respectively.
- d. Click the **Time Zone** tab.

Figure 9-8

Date/Time Properties dialog box (Time Zone tab)



- e. Click the **t** button to select the time zone.
- f. If you want to set daylight savings time automatically, enter a check mark (✓) in the **Automatically adjust clock for daylight saving changes** check box.
- g. Click the **OK** button.

**NOTE**

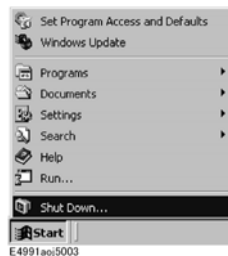
When you want to execute a setting change for the mouse at the same time, proceed to Step 3 on page 200 for “Setting the Mouse” (doing both procedures at this time will require you to restart the E4991A only once).

- h. Click the **x** button in the **Control Panel** window to close the window.

**Step 3. Shutting down and restarting the E4991A.**

- a. Click **Start - Shut Down...** (Figure 9-9).

**Figure 9-9** Click **Start - Shut Down**.



- b. Click the **Shut down** option button and then click the **OK** button (Figure 9-10). The E4991A will shut down.

**Figure 9-10** Shut down dialog box



- c. When the power of the E4991A is off, press the Standby switch once to activate the switch and then press it again to turn on the power.

## Setting the Mouse

The user can change the setup for the mouse connected to the E4991A and the movement of the pointer.

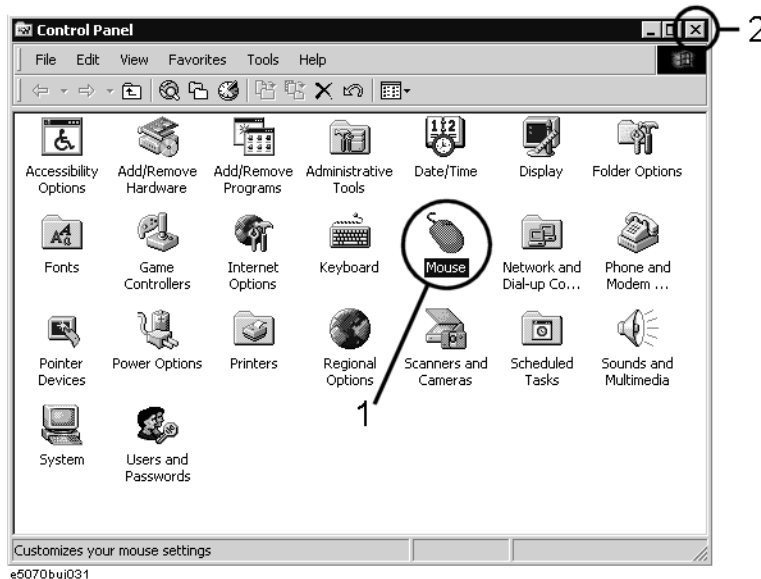
### Setup Step

**NOTE** Be sure to use a mouse and a keyboard for mouse setup operations.

- Step 1.** Exiting the E4991A system program.
  - a. Click System - Exit in the menu bar. The Enter Password to exit dialog box (Figure 9-2) opens.
  - b. Click the Keyboard... button and use the displayed character entry dialog box or use an external keyboard to enter the password e4991a in the Password box.
  - c. Click the OK button to exit the E4991A system.
- Step 2.** Click the Start button in the lower-left corner of the screen and select **Settings - Control Panel** (Figure 9-5). This will open the **Control Panel** window (Figure 9-11).

Figure 9-11

### Control Panel Window



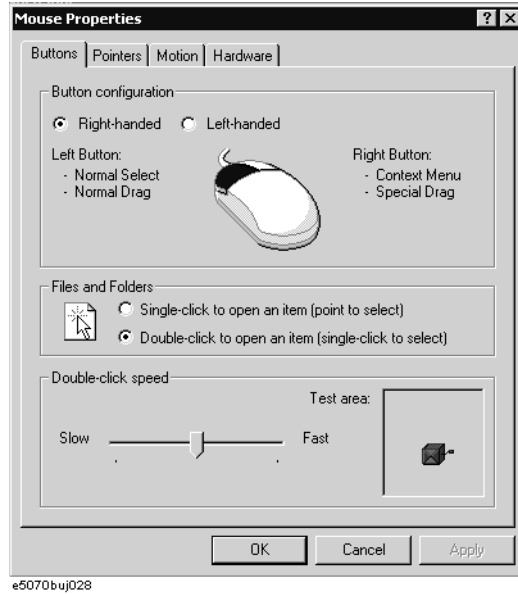
- Step 3.** Double-click the **Mouse** icon (1 in Figure 9-11) in the Control Panel window.

**NOTE** Do not click icons other than specified here or do not change other settings because doing so may cause serious damage to the functions of the E4991A.

**Step 4.** The Mouse Properties dialog box (Figure 9-12) is displayed.

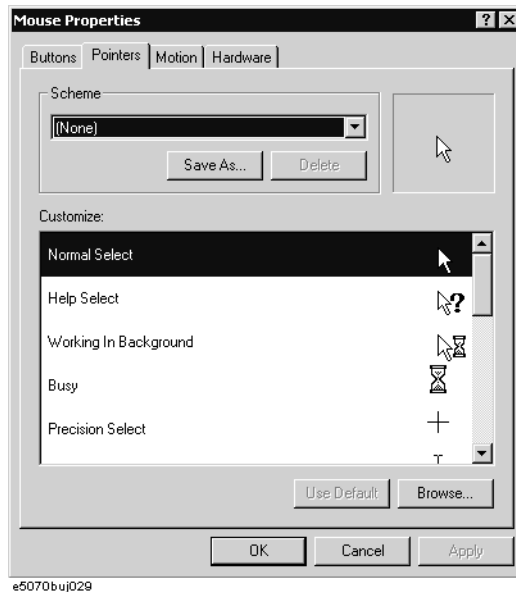
Define the setup for a right-handed/left-handed person in the **Buttons configuration** area. Define also the setup for double-click speed in the **Double-click speed** area.

**Figure 9-12** Mouse Properties Dialog Box (Buttons tab)



**Step 5.** Click the **Pointers** tab (Figure 9-13).

**Figure 9-13** Mouse Properties Dialog Box (Pointers tab)



## Setup and Use of Control/Management Functions

### Setting the Mouse

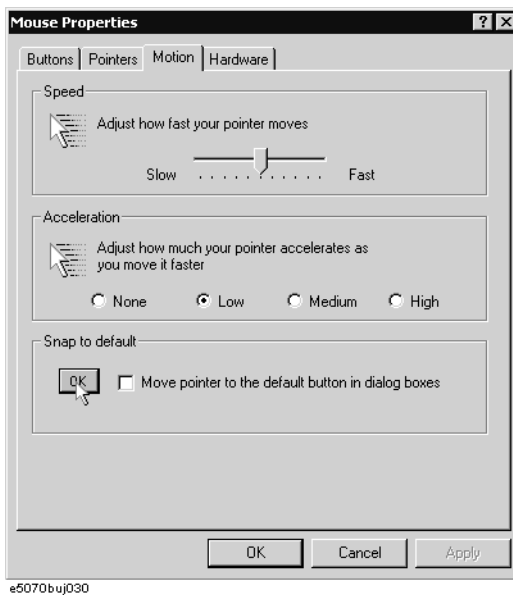
**Step 6.** Enter a registration name into the **Scheme** box and specify the shapes of pointers for the registration name in the box below.

To create a registration name, click the **Save As...** button. Enter the registration name into the **Save Scheme** dialog box that appears, and click the **OK** button.

**Step 7.** Click the **Motion** tab (Figure 9-14).

Figure 9-14

Mouse Properties Dialog Box (Motion tab)



**Step 8.** Specify the pointer speed in the **Pointer speed** area and the pointer trail in the **Pointer trail** area.

**Step 9.** Click the **OK** button.

**Step 10.** Click the × button (1 in Figure 9-11) at the corner in the Control Panel window.

#### NOTE

When you want to execute a setting change for the internal clock at the same time, proceed to Step 2-b for “Setting the Internal Clock” on page 197. (doing both procedures at this time will require you to restart the E4991A only once).

**Step 11.** Shutting down and restarting the E4991A.

- Click Start - Shut Down... (Figure 9-7).
- Click the Shut down option button and then click the OK button (Figure 9-8). The E4991A will shut down.
- When the power of the E4991A is off, press the Standby switch once to activate the switch and then press it again to turn on the power.



---

## Confirmation of Options and Firmware Version

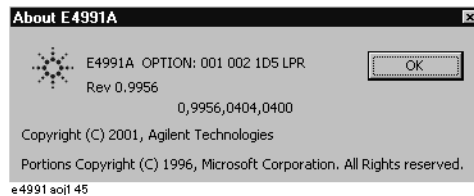
The options and the version of firmware installed in the E4991A can be confirmed by following the procedure below.

### Operation Procedure

- Step 1.** Open the shortcut menu by right-clicking and select **System** (Or press **System**).
- Step 2.** Click the **About E4991A** button. This opens the **About E4991A** dialog box (Figure 9-15), where you can confirm the installed options and firmware version.

Figure 9-15

About E4991A dialog box



- Step 3.** Close the **About E4991A** dialog box by clicking the **OK** button.

## **System Recovery**

By executing system recovery, you can return the system of the E4991A (the Windows operating system and the firmware) to the factory state (at the time of purchase <sup>\*1</sup>).

### **Types of system recoveries**

The following two types of system recoveries are available.

- o Factory recovery  
Returns the contents of the C drive to the factory state.
- o User recovery <sup>\*2</sup>  
Returns the contents of the C drive to a user-specified state. To use this function, you must prepare for recovery in advance. For information on preparation, see “Procedure to create the user backup image” on page 208 for information on the execution. Also, see “Procedure to execute the user recovery function” on page 211.

### **Notes on executing system recovery**

Executing system recovery causes the following:

- o In addition to the Windows operating system and the firmware, the following settings of the E4991A are returned to the factory state.
  - Network setting
  - GPIB setting
  - Printer setting
- o The driver for the supported printer installed after purchase is deleted.
- o You need to execute initial registration again.

Files you created using the save function (files in the D drive) are not affected, but we recommend backing them up before executing system recovery for precautionary purposes.

---

\*1. If the hard disk failed and has been replaced after purchase, the state when the replacement was performed is recovered.

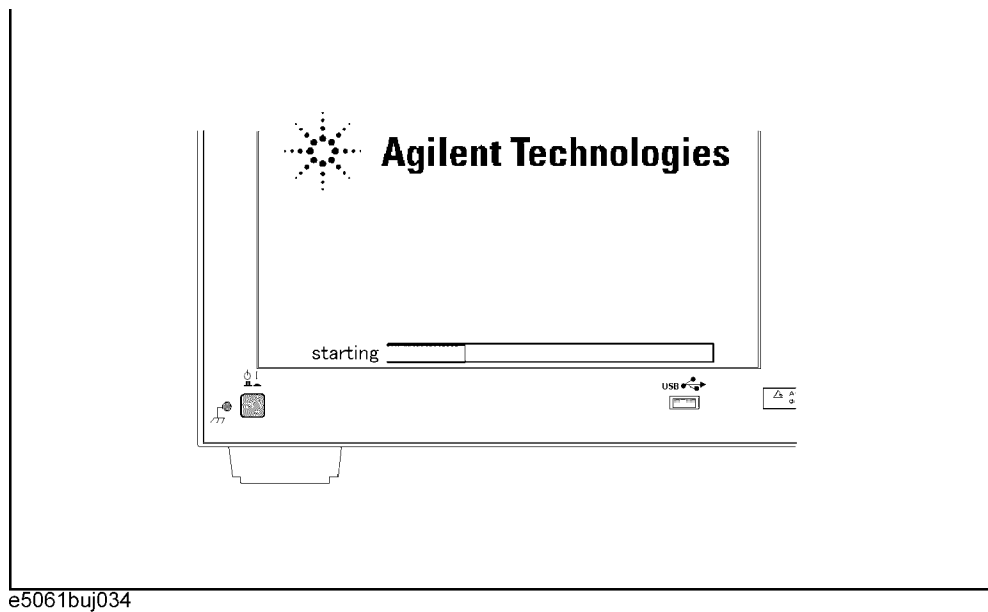
\*2. This function is available when the volume label on the hard disk is IG201 or higher.

### Procedure to execute system recovery

This section describes how to return the contents of the C drive to the factory state.

**NOTE** You need the keyboard for this operation.

- Step 1.** Shut down the E4991A.
- Step 2.** Connect the keyboard to the E4991A.
- Step 3.** Insert the disk for the system recovery into the floppy disk drive of the E4991A.
- Step 4.** Press the standby switch of the E4991A to turn it on.
- Step 5.** When the screen as shown in the figure below appears, press and hold **Esc** of the keyboard until this screen disappears.



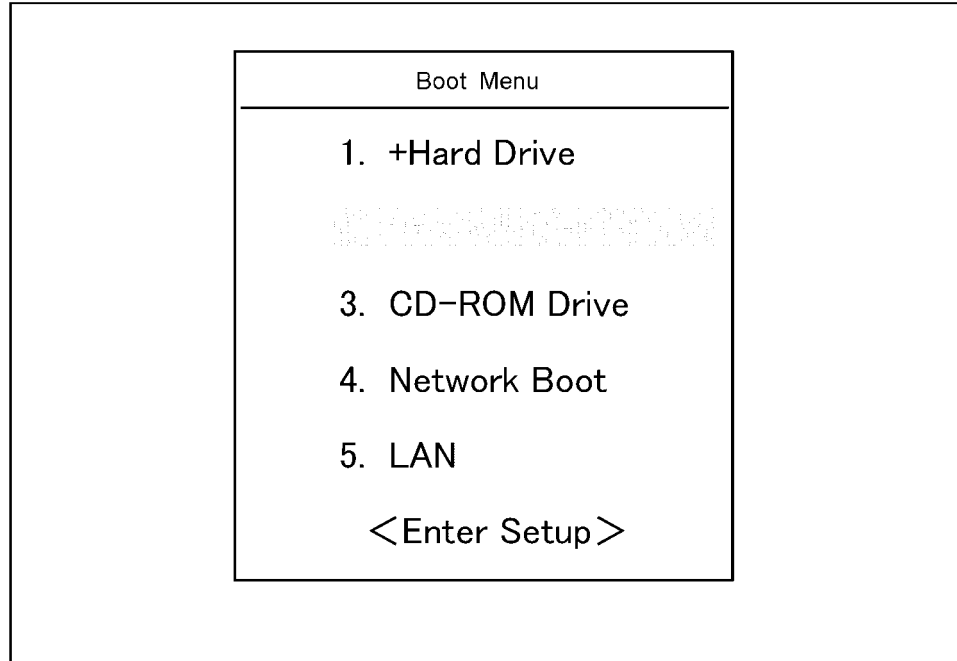
**NOTE** After several seconds, the next screen appears automatically even if you do not press any key, so do not miss it.

If the above message does not appear, the instrument is at fault; contact your local Agilent customer center listed at the end of this manual or distributor.

## Setup and Use of Control/Management Functions

### System Recovery

**Step 6.** The following screen appears. Select “+Removable Devices” with   of the keyboard, and press  of the keyboard.



**Step 7.** The message as shown below appears. Press  of the keyboard. If you want to cancel the factory recovery, press  here.

Agilent Technologies System Utilities  
Recovery & Backup Options

Choose One of the following:

- 
1. Recover Factory Backup Image
  2. Create User Backup Image
  3. Recover User Backup Image
  4. Exit
- 

Enter a Choice: \_

#### NOTE

If the above message does not appear, the instrument or the disk for the system recovery is at fault; contact your local Agilent customer center listed at the end of this manual or distributor.

- Step 8.** The message as shown below appears. Press **C** of the keyboard. If you want to cancel the system recovery, press **E** here.

You chose to Restore your system by installing the original factory installed OS and system software.

WARNING: Press C to Continue only if you are sure that you want to proceed. The C: Drive will be completely overwritten with no chance of recovering any data. Use Option 1 to recover the system from a serious malfunction caused by corrupted or inadvertently deleted files on the system's primary C: partition.

Press C to Continue or E to Exit: \_

- Step 9.** The message as shown below appears. Press **C** of the keyboard to start the factory recovery. If you want to cancel the factory recovery, press **E** here.

CAUTION! Interrupting this process may leave the system in an unstable state. Allow the software to complete the backup and recovery process. This may take up to 20 minutes depending on the system configuration.

Press C to Continue or E to Exit: \_

---

**CAUTION**

**Never turn off the power during the factory recovery because doing so may cause serious damage to the E4991A.**

- Step 10.** The factory recovery will be complete in about 5 minutes. When the factory recovery is complete, the message as shown below appears. Press **Ctrl**, **Alt**, and **Delete** of the keyboard at the same time to restart.

Remove the disk and Press CLT+ALT+DEL to restart your system.

---

**NOTE**

If the above message does not appear, the instrument is at fault; contact your local Agilent customer center listed at the end of this manual or distributor.

- Step 11.** After restart, the screen for initial registration appears. Execute initial registration. For information on the execution procedure, refer to *Installation/Quick Start Guide*.

### Procedure to create the user backup image

This section describes how to create the user backup image. The C drive contents saved in this creation are recalled when the user recovery function is executed.

---

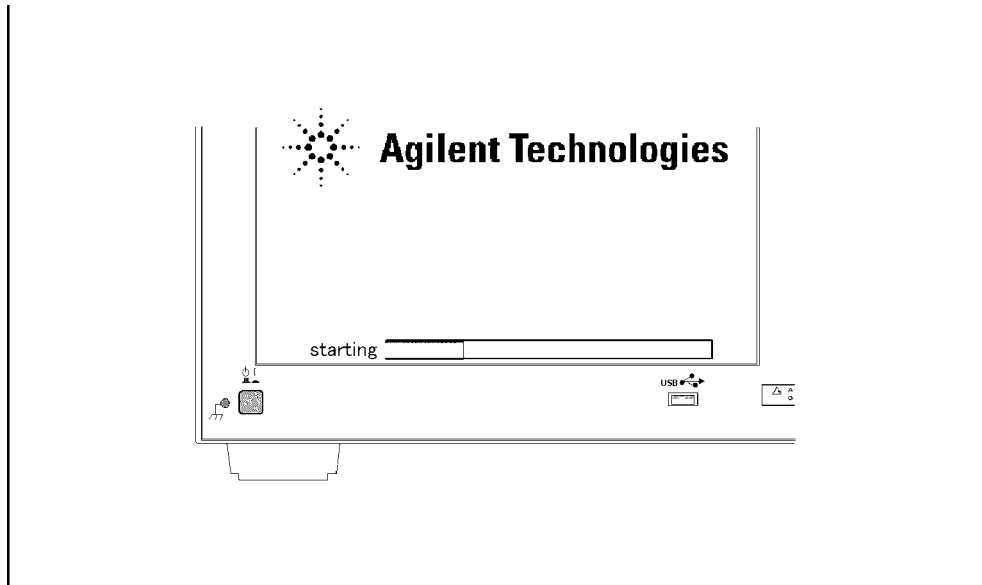
**NOTE** This function is available when the volume label on the hard disk is IG201 or higher.

---

**NOTE** You need the keyboard for this operation.

---

- Step 1.** Shut down the E4991A.
- Step 2.** Connect the keyboard to the E4991A.
- Step 3.** Insert the disk for the system recovery into the floppy disk drive of the E4991A.
- Step 4.** Press the standby switch of the E4991A to turn it on.
- Step 5.** When the screen as shown in the figure below appears, press and hold **Esc** of the keyboard until this screen disappears.



e5061buj034

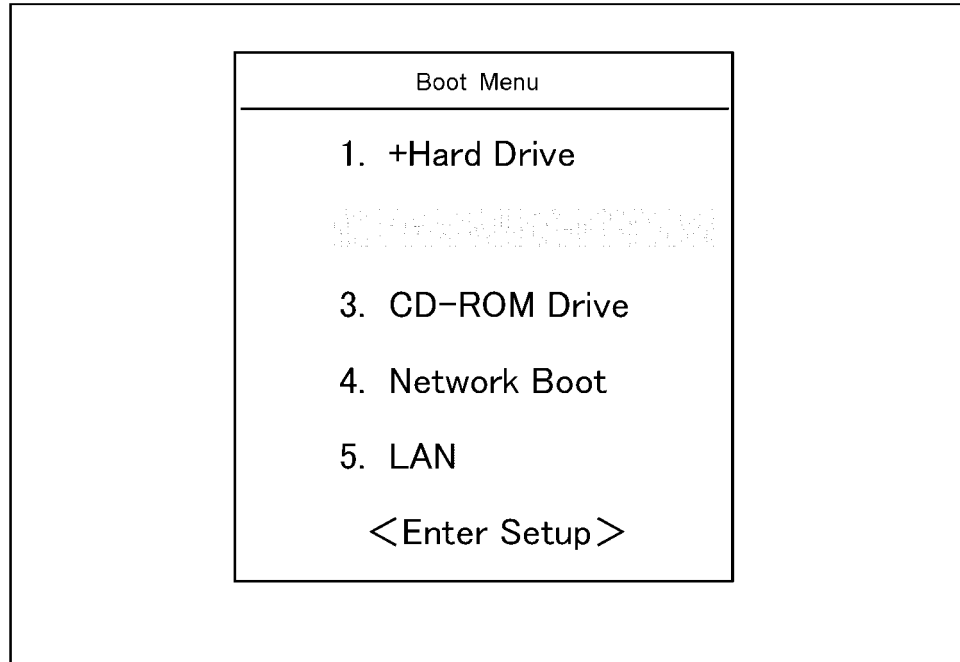
---

**NOTE** After several seconds, the next screen appears automatically even if you do not press any key, so do not miss it.

If the above message does not appear, the instrument is at fault; contact your local Agilent customer center listed at the end of this manual or distributor.

---

**Step 6.** The following screen appears. Select “+Removable Devices” with   of the keyboard, and press  of the keyboard.



**Step 7.** The message as shown below appears. Press  of the keyboard. If you want to cancel the create user backup image, press  here.

```
Agilent Technologies System Utilities
Recovery & Backup Options
```

Choose One of the following:

- 
1. Recover Factory Backup Image
  2. Create User Backup Image
  3. Recover User Backup Image
  4. Exit
- 

Enter a Choice: \_

**NOTE**

If the above message does not appear, the instrument or the disk for the system recovery is at fault; contact your local Agilent customer center listed at the end of this manual or distributor.

## Setup and Use of Control/Management Functions

### System Recovery

- Step 8.** The message as shown below appears. Press **C** of the keyboard. If you want to cancel the create user backup image, press **E** here.

You chose to create a backup image file of your system.

The system will perform a quick integrity check of the file structure on the C: Drive. It will then copy the C: partition to an image file and store it on the System Recovery partition.

Press C to Continue or E to Exit: \_

- Step 9.** The message as shown below appears. Press **C** of the keyboard to start the create user backup image. If you want to cancel the create user backup image, press **E** here.

CAUTION! Interrupting this process may leave the system in an unstable state. Allow the software to complete the backup and recovery process. This may take up to 20 minutes depending on the system configuration.

Press C to Continue or E to Exit: \_

---

#### CAUTION

**Never turn off the power during the create user backup image because doing so may cause serious damage to the E4991A.**

- Step 10.** The create user backup image will be complete in about 5 minutes. When the create user backup image is complete, the message as shown below appears. Press **Ctrl**, **Alt**, and **Delete** of the keyboard at the same time to restart.

Remove the disk and Press CLT+ALT+DEL to restart your system.

---

#### NOTE

If the above message does not appear, the instrument is at fault; contact your local Agilent customer center listed at the end of this manual or distributor.



### Procedure to execute the user recovery function

Returns the contents of the C drive to a user-specified state. To use this function, you must create the user backup image in advance. For more information, see the description “Procedure to create the user backup image” on page 208.

---

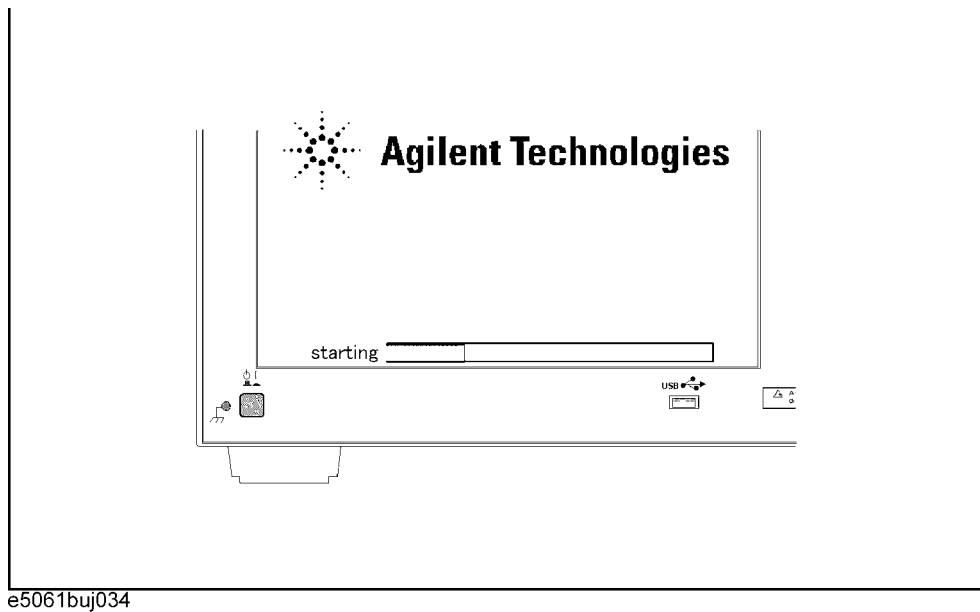
**NOTE** This function is available when the volume label on the hard disk is IG201 or higher.

---

**NOTE** You need the keyboard for this operation.

---

- Step 1.** Shut down the E4991A.
- Step 2.** Connect the keyboard to the E4991A.
- Step 3.** Insert the disk for the system recovery into the floppy disk drive of the E4991A.
- Step 4.** Press the standby switch of the E4991A to turn it on.
- Step 5.** When the screen as shown in the figure below appears, press and hold **Esc** of the keyboard until this screen disappears.



---

**NOTE** After several seconds, the next screen appears automatically even if you do not press any key, so do not miss it.

---

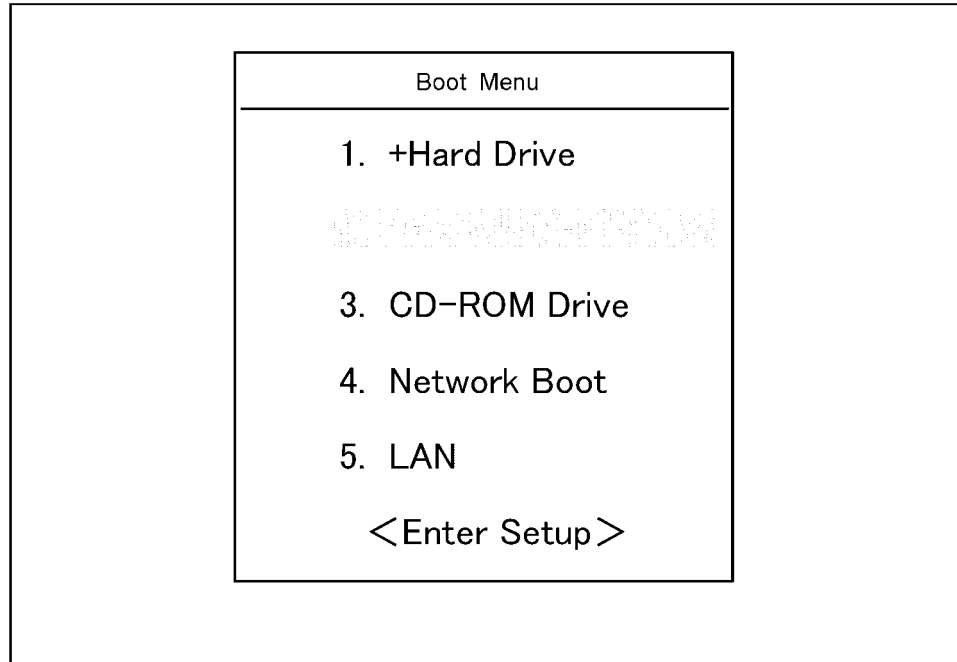
If the above message does not appear, the instrument is at fault; contact your local Agilent customer center listed at the end of this manual or distributor.

---

## Setup and Use of Control/Management Functions

### System Recovery

**Step 6.** The following screen appears. Select “+Removable Devices” with   of the keyboard, and press  of the keyboard.



**Step 7.** The message as shown below appears. Press  of the keyboard. If you want to cancel the user recovery, press  here.

```

Agilent Technologies System Utilities
Recovery & Backup Options

Choose One of the following:

```

- 
1. Recover Factory Backup Image
  2. Create User Backup Image
  3. Recover User Backup Image
  4. Exit
- 

Enter a Choice: \_

#### NOTE

If the above message does not appear, the instrument or the disk for the system recovery is at fault; contact your local Agilent customer center listed at the end of this manual or distributor.

- Step 8.** The message as shown below appears. Press **C** of the keyboard. If you want to cancel the user recovery, press **E** here.

You chose to recover your own system backup image file.

WARNING: Press C to Continue only if you are sure that you want to proceed. The C: partition will be completely overwritten with no chance of recovering any data. Use Option 3 to recover the system from a serious malfunction caused by corrupted or inadvertently deleted files on the system's primary C: partition.

Press C to Continue or E to Exit: \_

- Step 9.** The message as shown below appears. Press **C** of the keyboard to start the user recovery. If you want to cancel the user recovery, press **E** here.

CAUTION! Interrupting this process may leave the system in an unstable state. Allow the software to complete the backup and recovery process. This may take up to 20 minutes depending on the system configuration.

Press C to Continue or E to Exit: \_

---

**CAUTION**

**Never turn off the power during the system recovery because doing so may cause serious damage to the E4991A.**

- Step 10.** The user recovery will be complete in about 5 minutes. When the user recovery is complete, the message as shown below appears. Press **Ctrl**, **Alt**, and **Delete** of the keyboard at the same time to restart.

Remove the disk and Press CLT+ALT+DEL to restart your system.

---

**NOTE**

If the above message does not appear, the instrument is at fault; contact your local Agilent customer center listed at the end of this manual or distributor.



---

---

# 10

## Using LAN

This chapter explains how to transfer files and perform remote operations from an external computer by connecting the E4991A to a Local Area Network (LAN).

---

## Configuring the Network

---

### NOTE

When you use the E4991A by connecting it to your LAN, consult your network administrator and make the setting of the LAN correctly.

This section describes how to set the following basic items necessary to connect the E4991A to the LAN (Local Area Network).

- o “Enabling/disabling network” on page 216
- o “Setting IP address” on page 218
- o “Specifying computer name” on page 220

If you need detail network settings, consult your network administrator and perform operation in the same way as the Windows 2000® PC.

### Enabling/disabling network

You can enable/disable the network connection function of the E4991A.

Follow these steps to enable/disable the network connection function.

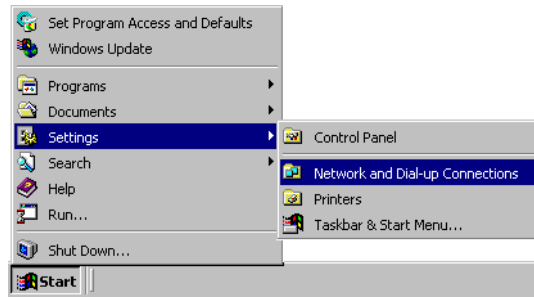
- Step 1.** Use the LAN cable to connect the E4991A to the LAN.
- Step 2.** Exit from the E4991A system program.
  - a. Click System - Exit from the menu bar. This opens the Enter Password to exit dialog box (Figure 10-1).

**Figure 10-1** Enter Password to exit dialog box

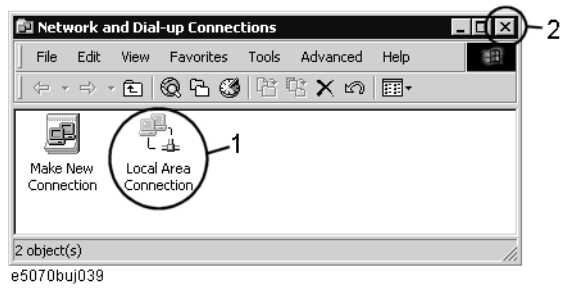


- b. Enter the password: e4991a into the Password box by using the character input dialog box that appears by clicking the Keyboard... button or by using the external keyboard.
    - c. Exit from the E4991A system by clicking the OK button.
- Step 3.** Click the **Start** button at the lower left of the screen to select **Settings - Network and Dial-up Connections** (Figure 10-3). This opens Network and Dial-up Connections window (Figure 10-3).

**Figure 10-2** Select Network and Dial-up Connections



**Figure 10-3** Network and Dial-up Connections window



## Using LAN Configuring the Network

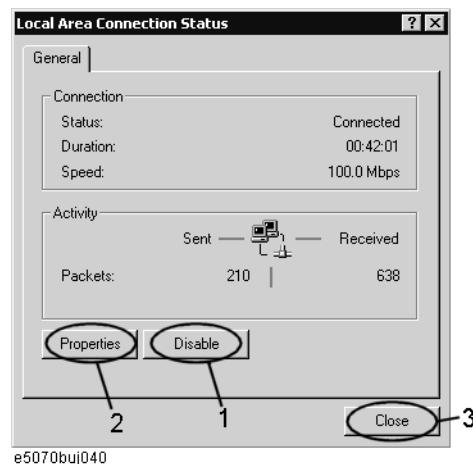
### Step 4. When switching from disable to enable:

Double-click the Local Area Connection icon (1 in Figure 10-3) in the Network and Dial-up connections window to enable the network connection function.

### When switching from enable to disable:

Double-click the Local Area Connection icon (1 in Figure 10-3) in the Network and Dial-up Connections window. The Local Area Connection Status dialog box (Figure 10-4) appears. Click the **Disable** button (1 in Figure 10-4) to disable the network connection function.

Figure 10-4 Local Area Connection Status dialog box



**Step 5.** Click the × button (2 in Figure 10-3) in the upper right of the Network and Dial-up Connections window.

## Setting IP address

Follow these steps to set the IP address:

**Step 1.** Exit from the E4991A system program.

- Click **System -Exit** from the menu bar. The Enter Password to exit dialog box appears.
- Enter the password: e4991a into the Password box by using the character input dialog box that appears by clicking the Keyboard... button or by using the external keyboard.
- Click the OK button to exit the E4991A system.

**Step 2.** Click the **Start** button at the lower left of the screen to select **Settings - Network and Dial-up Connections** (Figure 10-3). This opens Network and Dial-up Connections window (Figure 10-3).

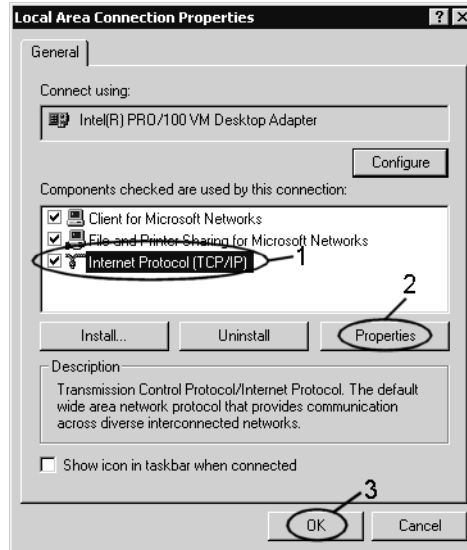
**Step 3.** Double-click the Local Area Connection icon (1 in Figure 10-3) in the Network and Dial-up Connections window. The Local Area Connection Status dialog box (Figure 10-4) appears. Click the **Properties** button (2 in Figure 10-4).



**Step 4.** The Local Area Connection Properties dialog box (Figure 10-5) appears. Select (highlight) **Internet Protocol (TCP/IP)** (1 in Figure 10-5) and then click the **Properties** button (2 in Figure 10-5).

Figure 10-5

Local Area Connection Properties dialog box

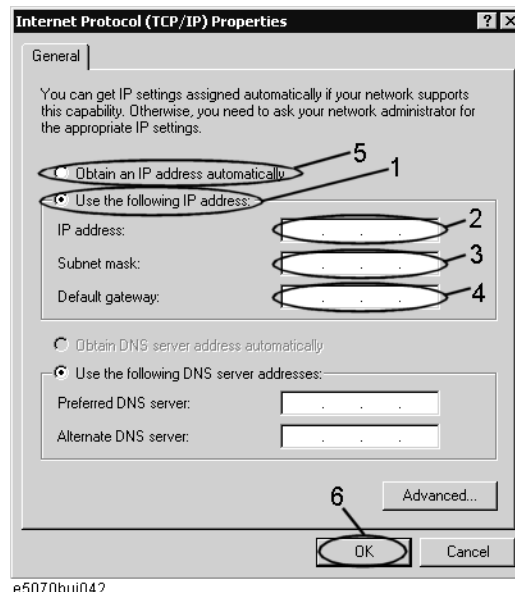


**Step 5.** The Internet Protocol (TCP/IP) Properties dialog box (Figure 10-6) appears. Click (select) **Use the following IP address** (1 in Figure 10-6) and then enter the IP address (2 in Figure 10-6), the subnet mask (3 in Figure 10-6), and the gateway address (4 in Figure 10-6).

If the IP address can be obtained automatically (if the DHCP server can be used), click (select) **Obtain an IP address automatically** (5 in Figure 10-6).

Figure 10-6

Internet Protocol (TCP/IP) Properties dialog box



e5070bu042

## Using LAN Configuring the Network

- Step 6.** In the Internet Protocol (TCP/IP) Properties dialog box, click the **OK** button (6 in Figure 10-6).
- Step 7.** In the Local Area Connection Properties dialog box, click the **OK** button (3 in Figure 10-5).
- Step 8.** In the Local Area Connection Status dialog box, click the **Close** button (3 in Figure 10-4).
- Step 9.** Click the × button (2 in Figure 10-3) in the upper right of the Network and Dial-up Connections window.

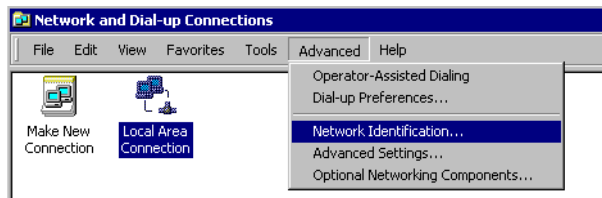
### Specifying computer name

Follow these steps to specify the computer name:

- Step 1.** Exit from the E4991A system program.
  - a. Click **System -Exit** from the menu bar. The Enter Password to exit dialog box (Figure 10-1) appears.
  - b. Enter the password: e4991a into the Password box by using the character input dialog box that appears by clicking the Keyboard... button or by using the external keyboard.
  - c. Click the OK button to exit the E4991A system.
- Step 2.** Click the **Start** button at the lower left of the screen to select **Settings - Network and Dial-up Connections** (Figure 10-3). This opens Network and Dial-up Connections window (Figure 10-3).
- Step 3.** Click the Advanced? Network Identification...from the menu bar of the Network and Dial-up Connections window.

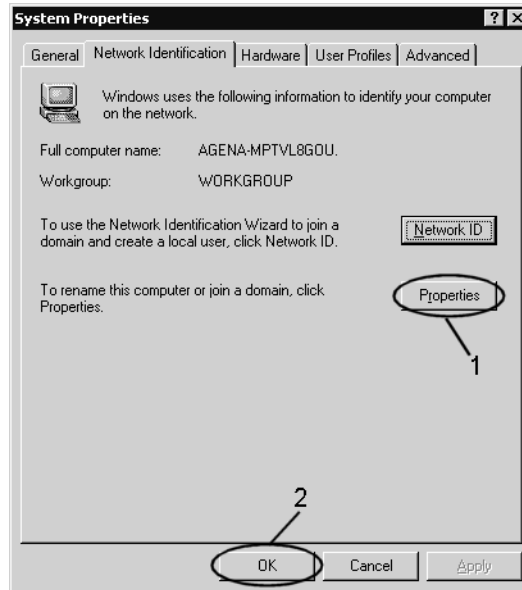
Figure 10-7

### Click the Advanced? Network Identification... from the menu bar



- Step 4.** The System Properties dialog box (Figure 10-8) appears. Click the **Properties** button (1 in Figure 10-8).

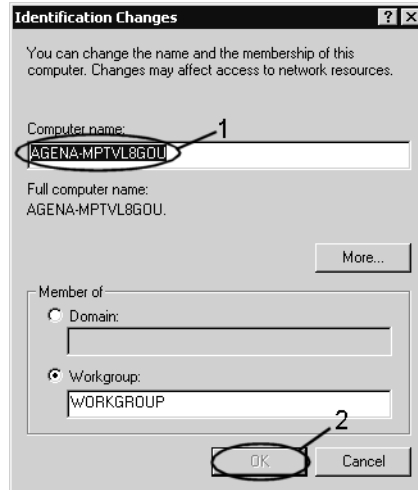
Figure 10-8 System Properties dialog box



e5070buj043

Step 5. The Identification Changes dialog box (Figure 10-9) appears. Enter the computer name in the **Computer Name** box (1 in Figure 10-9).

Figure 10-9 Identification Changes dialog box



e5070buj044

Step 6. The Network Identification dialog box (Figure 10-10) appears. Click the **OK** button.

Figure 10-10 Network Identification dialog box

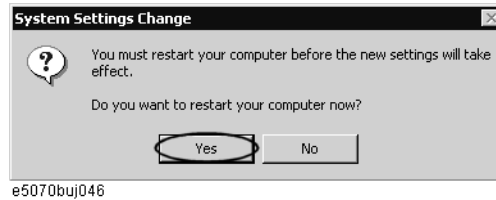


e5070buj045

## Using LAN Configuring the Network

- Step 7.** In the Identification Changes dialog box, click the **OK** button (2 in Figure 10-9).
- Step 8.** In the System Properties dialog box, click the **OK** button (2 in Figure 10-8).
- Step 9.** The System Settings Change dialog box (Figure 10-11) appears. Click the **Yes** button to restart the E4991A.

**Figure 10-11** System Settings Change dialog box



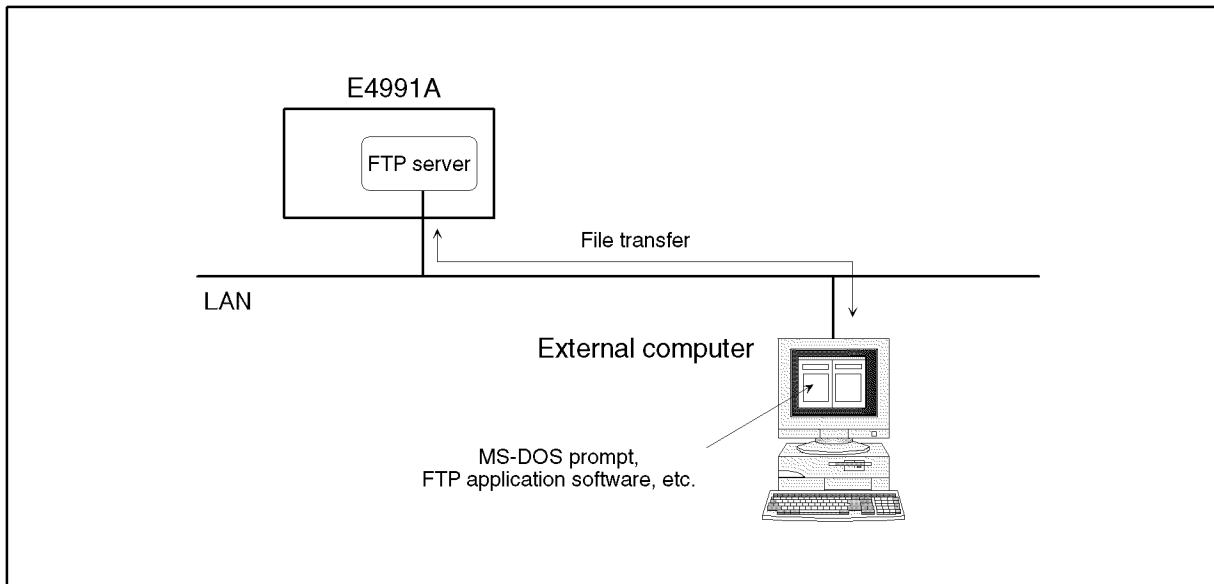
---

**NOTE** Until the E4991A is restarted, changed setting does not take effect.

## File Transfer Using FTP

Files can be transferred between the E4991A connected to a LAN and external computers by using the E4991A's File Transfer Protocol (FTP) server function.

**Figure 10-12** File transfer using FTP



### NOTE

No more than one FTP connection can be made to a single E4991A unit at the same time.

Refer to “Configuring the Network” on page 216 for connecting the E4991A to a LAN. Refer to your computer’s user manuals for how to connect the computer to the LAN.

The explanation given below assumes that you understand the basic computer operations under Windows™ and MS-DOS™ environments.

### FTP file transfer using MS-DOS™ prompt

You can connect to the E4991A FTP server and carry out file transfer by accessing the MS-DOS™ prompt (the software interface needed to use the MS-DOS™ window) on your computer under the Windows™ environment while connected to a LAN.

#### Operation Procedures

##### Step 1. Make the E4991A FTP server valid.

### NOTE

Validation of the E4991A’s FTP server is only available from the local user interface. For details on the local user interface and remote user interface, refer to “Using Remote User Interface” on page 228.

- a. Open the shortcut menu by right-clicking and select **System** (or press System).

## Using LAN File Transfer Using FTP

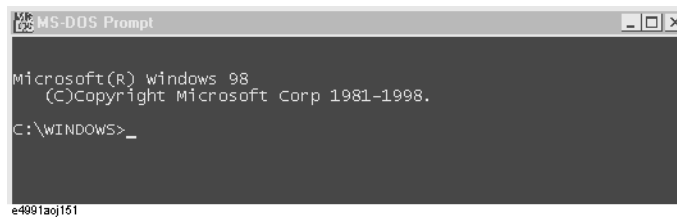
- b. Click the **FTP Server Menu** button.
- c. Click the **FTP Server** button to toggle it to On (Valid) if it is set to **FTP Server: [Off]**.

Indication on FTP Server button	Condition of FTP server
FTP Server: [On]	On (Valid)
FTP Server: [Off]	Off (Invalid)

### Step 2. Connect to the E4991A FTP server from an external computer

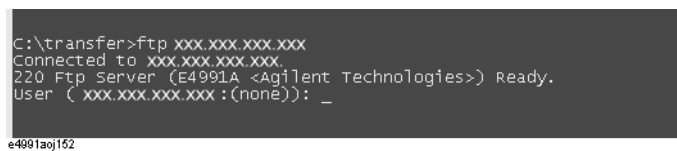
- a. Bring up the MS-DOS™ prompt on the external computer (Figure 10-13).

**Figure 10-13** MS-DOS™ prompt screen



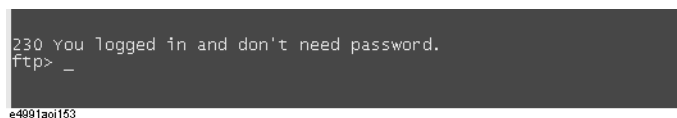
- b. Input commands after the MS-DOS™ prompt to shift the current directory of the computer to the directory where files are sent and received (for example C:\transfer).
- c. Type:  
**ftp <IP address>**  
(<IP address> is the IP address of the connected E4991A) or if the host name is specified, type:  
**ftp <hostname>**  
(<hostname> is the hostname of the connected E4991A, for example e4991a\_01) after the MS-DOS™ prompt and press **Enter** (Figure 10-14).

**Figure 10-14** Connection to E4991A FTP server  
(xxx.xxx.xxx.xxx is the IP address of the connected E4991A)



- d. Press **Enter** without inputting anything, even though input of a user name is prompted by **User(xxx.xxx.xxx.xxx: (none)):**. The display then indicates that the connection is complete (Figure 10-15).

**Figure 10-15** After connection to E4991A FTP server.



### NOTE

The E4991A FTP server connection is not provided with a security function based on user name and password.

**Step 3. Using FTP commands**

FTP commands can be used after connection has been made to the FTP server. Common FTP commands are given in Table 10-1. Use the [Help] command in Table 10-1 to find out about other commands and their functions.

**Table 10-1 Common FTP commands (server: E4991A, client: external computer)**

FTP command	Function
ascii	Sets file transfer mode to ASCII
binary	Sets file transfer mode to binary
cd <i>remote_directory</i>	Changes the server's current directory to <i>remote_directory</i> .
delete <i>remote_file</i>	Deletes <i>remote_file</i> from the server
dir [ <i>remote_directory</i> ]	Shows a file list of the directory named <i>remote_directory</i> in the server. The list of the entire current directory's contents is indicated if <i>remote_directory</i> is not specified.
get <i>remote_file</i> [ <i>local_file</i> ]	Creates a copy of the server's <i>remote_file</i> on the client as <i>local_file</i> . The file name <i>remote_name</i> is kept as the client-side file name if a new file name <i>local_file</i> is not specified.
help	Shows the list of FTP commands.
help <i>command</i>	Gives a simple explanation of the command <i>command</i> .
lcd [ <i>local_directory</i> ]	Changes the current directory of the client to <i>local_directory</i> .
put <i>local_file</i> [ <i>remote_file</i> ]	Creates a copy of the client's <i>local_file</i> on the server as <i>remote_file</i> . The file name <i>local_file</i> is kept as the server-side file name if a new file name <i>remote_file</i> is not specified.
rmdir <i>remote_directory</i>	Deletes <i>remote_directory</i> from the server.
quit	Disconnects from the server to terminate FTP.

As an example, the following procedures would be followed for transferring (copying) a binary format data-saving file called sample.dat in the current directory of the E4991A (server) to the external computer (client) under the same file name.

- a. Type **binary** after the **ftp>** prompt and press **[Enter]** to set the file transfer mode to binary (Figure 10-16).

**Figure 10-16 Setting in binary transfer mode**

```
ftp> binary
200 Type set to I.
ftp> _
```

e4991a0j163

- b. Type **get sample.dat** after the **ftp>** prompt and press **[Enter]**. The file sample.dat on the E4991A is transferred to the working directory of the external computer (a copy is

## Using LAN File Transfer Using FTP

created) (Figure 10-17).

**Figure 10-17** Transfer sample.dat file to PC

```
ftp> get sample.dat
200 PORT Command Successful.
150 Opening Image mode data connection for file transfer
226 Transfer complete
ftp: 28037 bytes received in 0.22Seconds 127.44Kbytes/sec.
ftp> _
```

e4991a0j164

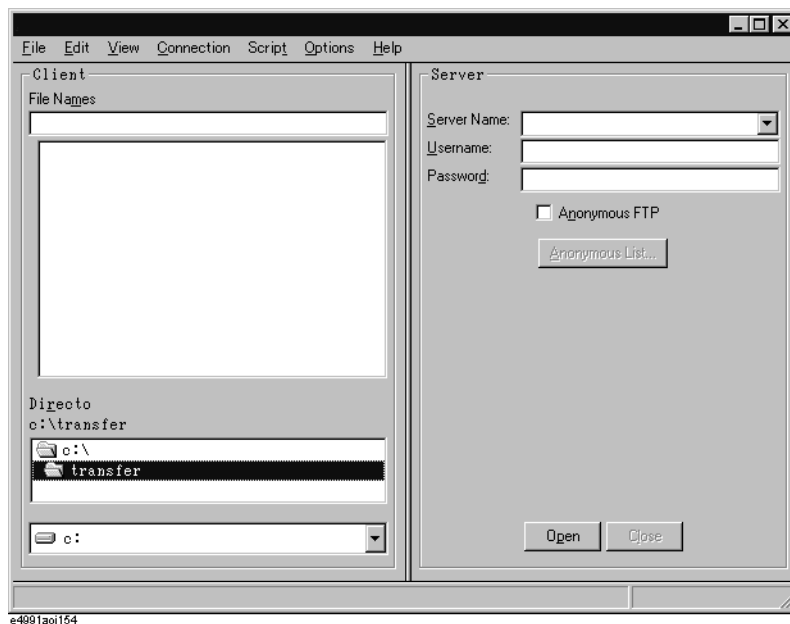
### FTP file transfer using FTP application software

Performing the operations of “FTP file transfer using MS-DOS‘ prompt” on page 223 is complicated because users need to remember FTP commands. The user can easily achieve FTP transfers by using commercial FTP application software with a graphical user interface, eliminating the need to learn commands.

#### Operation procedures

**Step 1.** Start up the FTP application software (Figure 10-18).

**Figure 10-18** FTP application software (Example)



**Step 2.** Input the IP address of the connected E4991A in the box provided for entering the server name (**Server Name** box in Figure 10-18).

**Step 3.** Specify Anonymous FTP if this option is available (put a check mark ✓ in the **Anonymous FTP** check box in Figure 10-18).

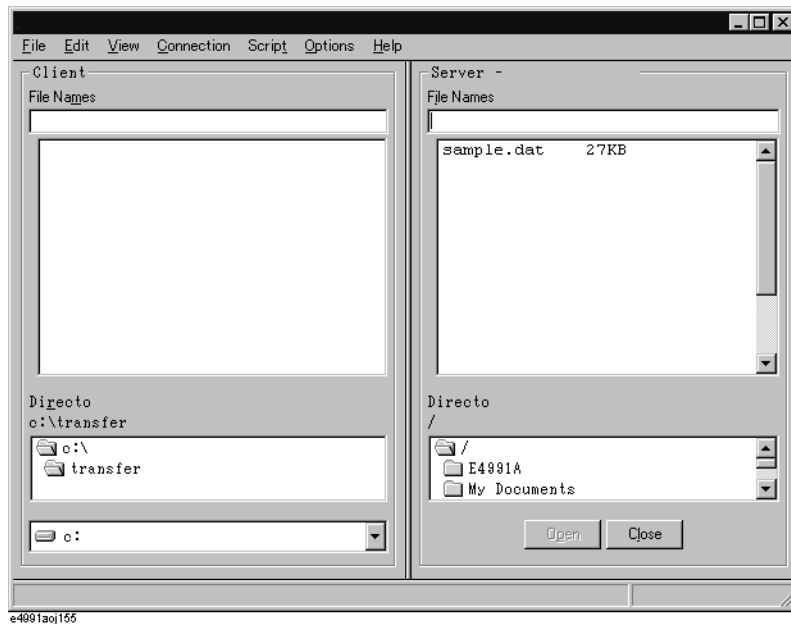
You can also input a user name in the box for user name input (**Username** box in Figure 10-18) instead of specifying Anonymous FTP.

**Step 4.** Connect to the FTP server (click the **Open** button in Figure 10-18).



Figure 10-19

Example of completed FTP server connection



The same operations as those used in Windows Explorer™, such as drag and drop, can be used with FTP application software after completion of a server connection (Figure 10-18). Refer to your FTP application software’s manual for further instructions.

### Stop/Abortion of process/Cut off from server by E4991A operation

Abortion of transfer and disconnection from the server can be accomplished by E4991A operations.

- Step 1.** Open the shortcut menu by right-clicking and select **system** (Or press **System**).
- Step 2.** Click the **FTP Server Menu** button.
- Step 3.** Click **FTP Server** button, **Abort** button, or **Disconnect** button to execute on-off switching of the server, abortion of process, or disconnection from the server, respectively.

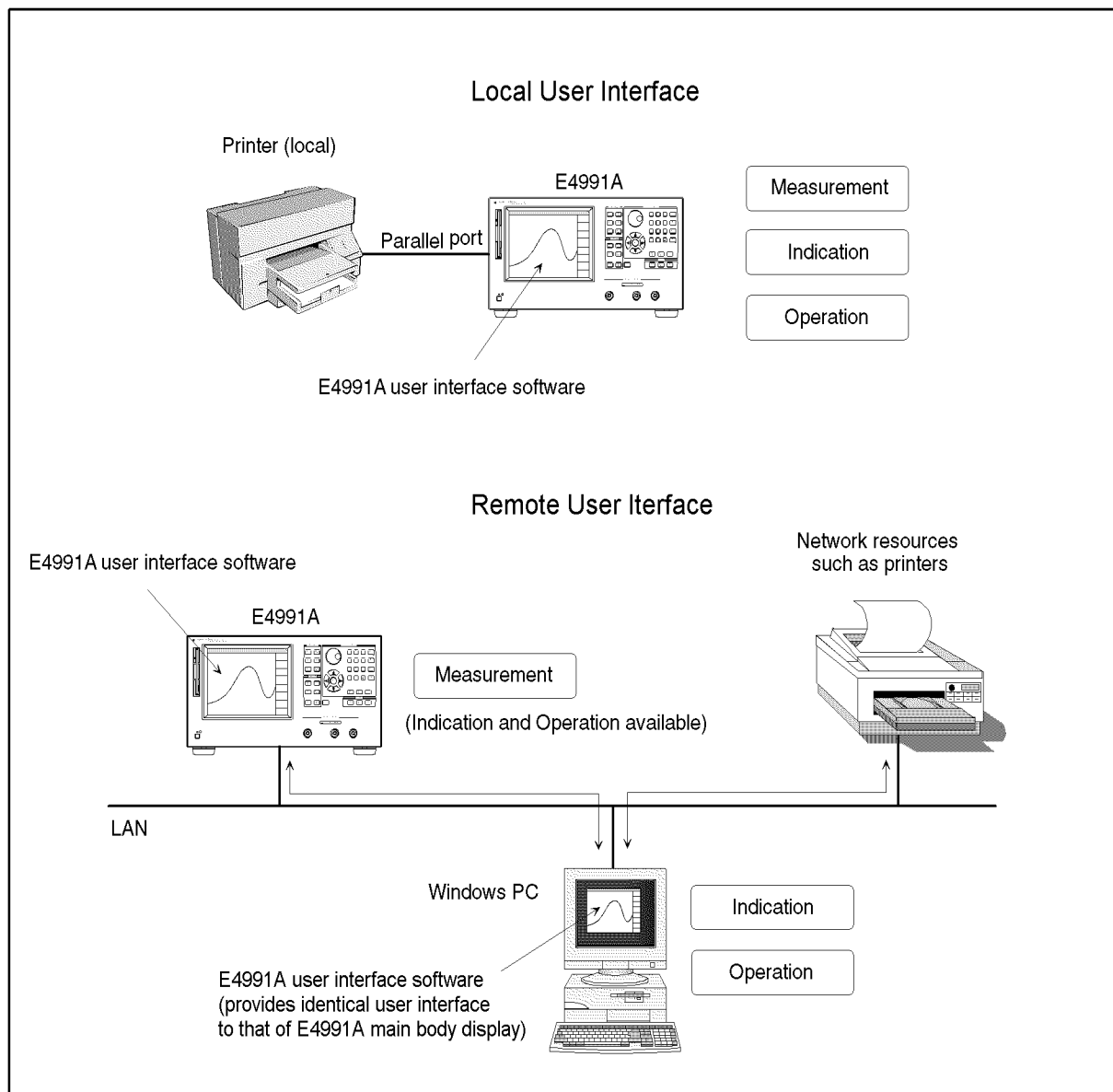
FTP server setup button	Function
<b>FTP Server</b>	Switches FTP server on and off. Connections from external computers cannot be made in off condition.
<b>Abort</b>	Aborts the process in execution. For example, aborts a file transfer.
<b>Disconnect</b>	Disconnects from the FTP server. Even after the connection is disconnected, reconnection from an external computer is possible if the <b>FTP Server</b> is <b>On</b> .

## Using Remote User Interface

### Outline of Remote User Interface

The E4991A LCD display's indication and various operations are controlled by the User Interface Software already installed in the E4991A. Remote operation of the E4991A from an external PC through a LAN can be achieved by installing this E4991A User Interface Software in the external PC (Figure 10-20).

**Figure 10-20** Local user interface and remote user interface



e4991a0e161

**Comparison of local U/I and remote U/I**

The local user interface and the remote user interface have the same functions except for the items listed in Table 10-2.

**Table 10-2**

**Different functions between local user interface and remote user interface**

	Local user interface	Remote user interface
Ability to connect to (disconnect from) a measurement server ( <b>System - Remote Setup Dialog</b> menu)	(automatically connected)	√
GPIB function	√	X
FTP server function	√	X
Ability to copy E4991A internal data and display's image as a graphic file onto the clipboard in the Windows™ OS	X	√ (Refer to “Copying measurement plot and internal data to other application software” on page 236)
Ability to minimize, change size of, and close application windows	X	√

√: function is available

X: function is not available

**NOTE**

*For devices such as hard disks and printers, only those that can work with the operation hardware (E4991A main body for local mode, PC for remote mode) are accessible. For example, the E4991A's internal hard disk (drive D) cannot be accessed from the remote user interface unless the E4991A's internal hard disk is connected to the external PC as a network drive.*

**Simultaneous operation of Local U/I and Remote U/I**

Only one remote user interface can be connected to a single E4991A at one time. Accordingly, the local user interface and remote user interface can be simultaneously operated.

In performing a function that is common to both user interfaces, operation on one user interface is simultaneously reflected on the other user interface. On the other hand, in performing a function that can be independently carried out by one user interface, that interface can be individually set up without affecting the other one. Table 10-3 lists the

common and independent functions of the two types of user interfaces.

**Table 10-3 Common and independent functions of the Local U/I and Remote U/I**

Common functions	Independent functions
<ul style="list-style-type: none"> <li>•Setup of Start/Stop (sweep range)</li> <li>•Setup of Sweep</li> <li>•Setup of Source</li> <li>•Setup of Cal/Compen</li> <li>•Execution of Trigger</li> <li>•Setup of Trigger Setup</li> </ul>	<ul style="list-style-type: none"> <li>•Selection of Active Trace</li> <li>•Setup of Meas/Format</li> <li>•Setup of Scale</li> <li>•Setup of Display</li> <li>•Setup of Marker</li> <li>•Setup of Marker Function</li> <li>•Setup of Utility</li> <li>•Operation of Save/Recall</li> </ul>

**NOTE** *When you operate the local U/I and the remote U/I simultaneously, the response time (time between operation and actual execution of commands in the E4991A) may be excessively long due to conflicting processes in the internal operations.*

**Required performance of external PC**

The performance requirements of the external PC used with the E4991A user interface software (including the E4991A VBA software) are listed in Table 10-4.

**Table 10-4 Required Performance of External PC for Remote User Interface**

Processor	Intel® Pentium® MMX 233 MHz equivalent or higher performance
Memory	128 MB or more
Operating System	Windows® 2000* <sup>1</sup> or Windows® XP,

\*1. English version is recommended.

**NOTE** The E4991A user interface software and the E4991A VBA software will operate under both American English and Japanese versions of Microsoft Windows (Windows 98, Windows NT 4.0, Windows 2000).

**Installation of E4991A user interface software**

**NOTE** *Be sure to take the following precautions before installing the E4991A user interface software and the E4991A VBA software in your external PC.*

- *First, back up your important files in the external PC to a CD-R or other backup medium. After installation, regularly back up your files.*
- *When you program with the E4991A VBA software installed on the external PC, save the program periodically while programming.*

*Agilent Technologies shall not be liable for any damages during installation and operation of the E4991A user interface software and the E4991A VBA software. Agilent Technologies does not warrant that the operation of this software will be uninterrupted or error-free under any environment.*

*Before using the E4991A VBA software, you must carefully read and accept the License Agreement attached to the product.*

When using the E4991A user interface from an external PC, the version number of the connected E4991A main body measurement server program (program to control measurement) and that of the E4991A user interface on the external PC must be identical.

### Step 1. Install E4991A user interface software on the external PC

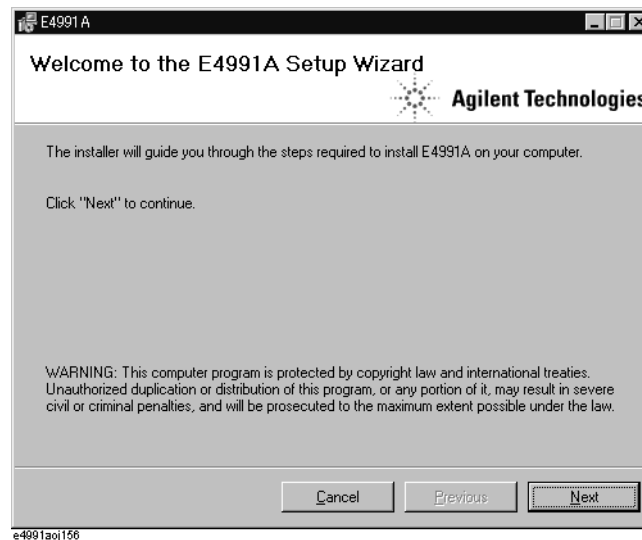
- a. Go <http://www.agilent.com/> with your browser of PC. Enter “e4991a firmware” in the search field, then click search.
- b. Click “E4991A RF Impedance/Material Analyzer Firmware Update”. There is two firmware files depends on the serial number of your product. (refer to the site.) Download your desired file on the your PC ( e.g. Desktop)

#### NOTE

Update the E4991A firmware to the latest revision when E4991A **Version Mismatch** dialog box (Figure 10-26) appears.

- c. Click the downloaded file (.exe) on the desktop of your PC to extract it.
- d. Move each files under directories of DISK\_2 and DISK\_3 to DISK\_1.
- e. Execute the file named **E4991.msi** in the DISK\_1.
- f. Follow the instructions of the E4991A Setup Wizard (Figure 10-21) to complete installation of the E4991A user interface software.

Figure 10-21 E4991A Setup Wizard



#### NOTE

The E4991A user interface software (E4991A.exe) start up icon is placed on the PC desktop after completion of E4991A user interface software installation.

The installer creates a new folder named “Agilent\E4991” in the program folder of the PC (usually the C:\Program File folder) and copies the program files of the E4991A user interface into it.

## Using LAN Using Remote User Interface

### Step 2. Install E4991A VBA software on the external PC

To use the VBA function of the E4991A user interface from an external PC, install the E4991A VBA software by following the procedure below after completing Step 1 on page 231.

---

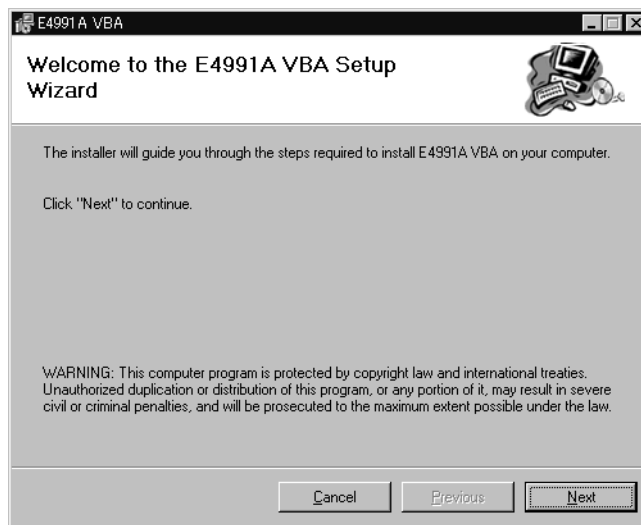
**NOTE**

The E4991A VBA software can be installed on only one PC for each E4991A purchased based on the licensing agreement. Installing this software on more than one PC per purchased E4991A violates the terms of this agreement.

---

- a. Execute the file named **E4991A\_vbs.msi** on the CD-ROM. This opens the VBA Setup Wizard (Figure 10-22).

**Figure 10-22** E4991A VBA Setup Wizard



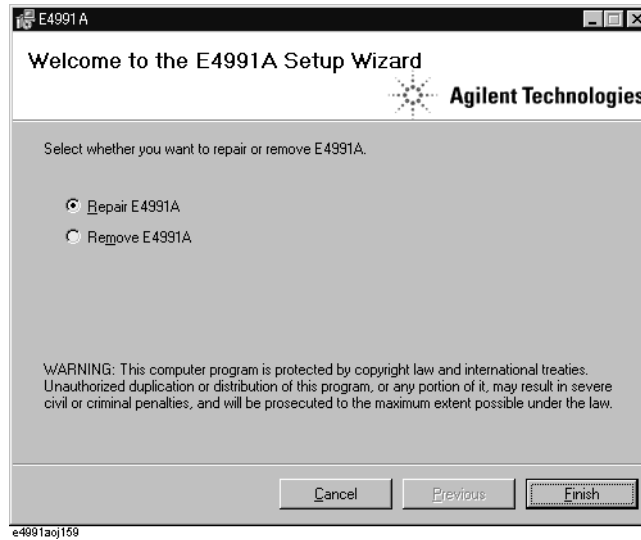
- b. Follow the instructions of the E4991A VBA Setup Wizard (Figure 10-22) to complete the E4991A VBA installation.

### Procedure to uninstall E4991A user interface

#### Step 1. Uninstall the E4991A user interface software

- a. Open the folder that downloaded according to Step 1 of “Installation of E4991A user interface software” on page 230.
- b. Execute the file named **e4991.msi** on the DISK\_1. This opens the E4991A Setup Wizard (Figure 10-21).

Figure 10-23 E4991A Setup Wizard (uninstall)



- c. Click the **Remove E4991A** option button to select it and then click the **Finish** button.

---

**NOTE**

Select the **Repair E4991A** option button if you need to correct operational trouble of the installed E4991A user interface. With this option, only the necessary files are renewed, so this operation is simpler than executing a full uninstall and reinstall.

- d. Follow the instructions of the E4991A Setup Wizard (Figure 10-23) to complete uninstall of the E4991A user interface software.

**Step 2. Uninstall of E4991A VBA software**

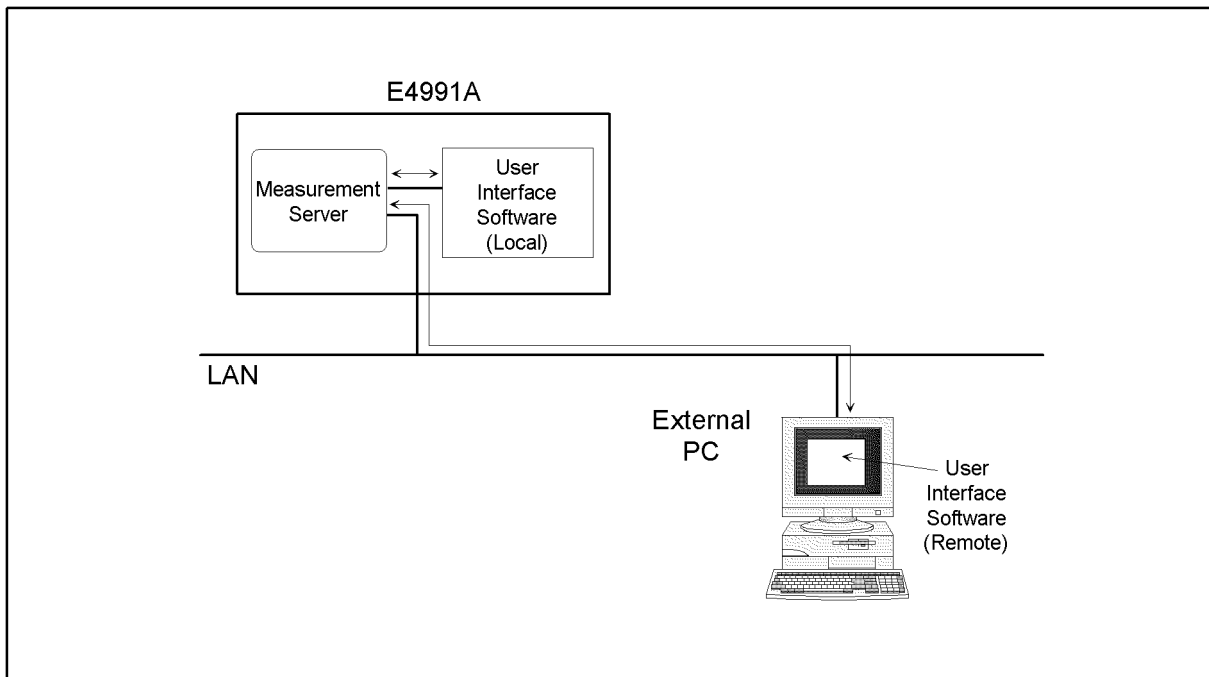
- a. Execute the file named **e4991a\_vba.msi** on the CD-ROM.
- b. Follow the same procedure shown in Step 1 above to complete uninstall of the E4991A VBA software.

**Starting up the E4991A user interface and connecting to the E4991A measurement server**

After you complete installation of the E4991A user interface software on the external PC, start up the software and connect the external PC to the E4991A measurement server (Figure 10-24).

Using LAN  
Using Remote User Interface

Figure 10-24 Connecting to the E4991A Measurement Server



e4991aoe179

Follow the instructions below.

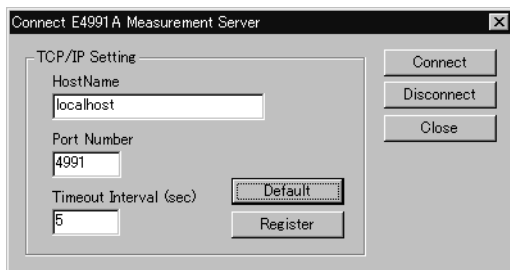
**Step 1.** Double-click the icon to start up the E4991A user interface

The E4991A user interface screen appears and the E4991A Measurement Server connection dialog box (Figure 10-25) pops up after a short time.

**NOTE**

Remote operation from the remote user interface can be done by connecting the remote PC to the measurement server of the E4991A.

Figure 10-25 Connect E4991A Measurement Server dialog box



e4991aoj158

**Step 2.** Input the IP address or host name of the connecting E4991A measurement server in the **Host Name** box.

**Step 3.** Input the timeout interval of connecting to a E4991A measurement server in the **Timeout Interval** box.

**Step 4.** Click the **Register** button to set the **Host Name** and **Timeout Interval** you entered as the initial values for the next start-up of the E4991A user interface. Click the **Default** button to



restore the settings to their factory default states.

---

**NOTE**

If you use the Windows NT 4.0 operating system on your PC, you need to log onto the PC as an administrator to enable the **Register** button.

---

- Step 5.** Click the **Connect** button to execute connection to the E4991A measurement server. Click the **Close** button or **X** button to close the dialog box without making a connection.

---

**NOTE**

Update the E4991A firmware to the latest revision when E4991A **Version Mismatch** dialog box (Figure 10-26) appears.

---

**Figure 10-26**

**Version Mismatch dialog box**



### **Disconnection of E4991A measurement server**

Follow the procedures below to disconnect the E4991A measurement server.

- Step 1.** Right-click on the E4991A user interface screen to open the shortcut menu and select **System**.
- Step 2.** Click the **Remote Setup Dialog** button. This opens the E4991A Measurement Server Connection dialog box (Figure 10-25).
- Step 3.** Click the **Disconnect** button.

## Closing the E4991A user interface

Click **System - Exit** from the menu bar (or click the **X** button) to close the E4991A user interface.

## Copying measurement plot and internal data to other application software

Plots of measurement results and lists of measurement data and measurement conditions (operating parameters) can be copied onto the Windows operating system clipboard on the E4991A user interface. The contents of the clipboard can be pasted directly into various types of application software (image processing software, word processing software, spreadsheet software, etc.). This provides simplified operation compared with loading other application software after saving the information in a separate file.

### Operation Procedure

- Step 1.** Right-click in the E4991A user interface to open the shortcut menu and select **Display**.
- Step 2.** Click the **Print/Clipboard Menu** button.
- Step 3.** Click the button indicating the content to be copied to the clipboard.

Clipboard copy button	Copy function
<b>Copy to Clipboard Graph (bmp)</b>	Copies plots shown on the screen to the clipboard in bmp format. When more than one window is open, this button will only copy the window of the active trace.
<b>Copy to Clipboard Graph (jpg)</b>	Copies plots shown on the screen to the clipboard in jpg format. When more than one window is open, this button will only copy the window of the active trace.
<b>Copy to Clipboard List Values</b>	Copies a data list (all measurement points) to the clipboard.
<b>Copy to Clipboard Operating Params</b>	Copies a list of operating parameters (measurement conditions) to the clipboard.

- Step 4.** Paste the contents of the clipboard directly into other applications.

---

# 11 Specifications and Supplemental Information

This chapter provides specifications and supplemental information for the Agilent E4991A RF Impedance/Material Analyzer.

## Definitions

All specifications apply over a 5°C to 40°C range (unless otherwise stated) and 30 minutes after the instrument has been turned on.

**Specification (spec.):** Warranted performance. Specifications include guardbands to account for the expected statistical performance distribution, measurement uncertainties, and changes in performance due to environmental conditions.

Supplemental information is intended to provide information that is helpful for using the instrument but that is not guaranteed by the product warranty. This information is denoted as either typical or nominal.

**Typical (typ.):** Expected performance of an average unit that does not include guardbands. It is not guaranteed by the product warranty.

**Nominal (nom.):** A general, descriptive term that does not imply a level of performance. It is not guaranteed by the product warranty.

## Measurement Parameters and Range

### Measurement Parameters

Impedance parameters	$ Z ,  Y , L_s, L_p, C_s, C_p, R_s (R), R_p, X, G, B, D, Q, \theta_z, \theta_y,  \Gamma , \Gamma_x, \Gamma_y, \theta_\gamma$
Material parameters (option 002)	(see “Option 002 Material Measurement (typical)” on page 263)
Permittivity parameters	$ \epsilon_r , \epsilon_r', \epsilon_r'', \tan \delta$
Permeability parameters	$ \mu_r , \mu_r', \mu_r'', \tan \delta$

### Measurement Range

Measurement range ( $ Z $ )	130 mΩ to 20 kΩ (Frequency = 1 MHz, Point averaging factor $\geq 8$ , Oscillator level = -3 dBm; = -13 dBm; or = -23 dBm, Measurement Accuracy $\leq \pm 10\%$ , Calibration is performed at 23°C $\pm 5^\circ\text{C}$ , Measurement is performed at calibration temperature $\pm 5^\circ\text{C}$ )
-----------------------------	---

## Source Characteristics

### Frequency

Range	1 MHz to 3 GHz
Resolution	1 mHz
Accuracy	
without Option 1D5	±10 ppm (23 ±5°C) ±20 ppm (5°C to 40°C)
with Option 1D5	±1 ppm (5°C to 40°C)
Stability	
with Option 1D5	±0.5 ppm/year (5°C to 40°C) (Typical)

### Oscillator Level

Range	
Power (when 50 Ω load is connected to test port)	– 40 dBm to 1 dBm (Frequency ≤ 1 GHz) – 40 dBm to 0 dBm (Frequency > 1GHz <sup>*1</sup> )
Current (when short is connected to test port)	0.0894 mArms to 10 mArms (Frequency ≤ 1 GHz) 0.0894 mArms to 8.94 mArms (Frequency > 1 GHz <sup>*1</sup> )
Voltage (when open is connected to test port)	4.47 mVrms to 502 mVrms (Frequency ≤ 1 GHz) 4.47 mVrms to 447 mVrms (Frequency > 1 GHz <sup>*1</sup> )
Resolution	0.1 dB <sup>*2</sup>
Power Accuracy	
Test Head <sup>*3</sup>	
Frequency ≤ 1 GHz	±2 dB (23 ± 5°C) ±4 dB (5°C to 40°C)
Frequency > 1 GHz	±3 dB (23 ±5°C) ±5 dB (5°C to 40°C)
Option 010 Probe Station Connection Kit	
Frequency ≤ 1 GHz	±5.5 dB (5°C to 40°C)
Frequency > 1 GHz	±7.6 dB (5°C to 40°C)

\*1. It is possible to set an oscillator level of more than 0 dBm (447 mV, 8.94 mA) at frequency > 1 GHz. However, the characteristics at this setting are not guaranteed.

\*2. When the unit is set at mV or mA, the entered value is rounded to 0.1 dB resolution.

\*3. When 50 Ω load is connected to test port of test head.

## Output Impedance

---

Output impedance                      50  $\Omega$  (nominal)

## DC Bias (Option 001)

### DC Voltage Bias

DC voltage bias

Range	0 to $\pm 40$ V
Resolution	1 mV
Accuracy	$\pm \{0.1\% + 6 \text{ mV} + (I_{dc}[\text{mA}] \times 20 \Omega)[\text{mV}]\}$ ( $23 \pm 5^\circ\text{C}$ ) $\pm \{0.2\% + 12 \text{ mV} + (I_{dc}[\text{mA}] \times 40 \Omega)[\text{mV}]\}$ ( $5^\circ\text{C}$ to $40^\circ\text{C}$ )

### DC Current Bias

DC current bias

Range	100 $\mu\text{A}$ to 50 mA, $-100 \mu\text{A}$ to $-50$ mA
Resolution	10 $\mu\text{A}$
Accuracy	$\pm \{0.2\% + 20 \mu\text{A} + (V_{dc}[\text{V}] / 10 \text{ k}\Omega)[\text{mA}]\}$ ( $23 \pm 5^\circ\text{C}$ ) $\pm \{0.4\% + 40 \mu\text{A} + (V_{dc}[\text{V}] / 5 \text{ k}\Omega)[\text{mA}]\}$ ( $5^\circ\text{C}$ to $40^\circ\text{C}$ )

### DC Bias Monitor

Monitor parameters	Voltage and Current
Voltage monitor accuracy	$\pm \{0.5\% + 15 \text{ mV} + (I_{dc}[\text{mA}] \times 2 \Omega)[\text{mV}]\}$ ( $23 \pm 5^\circ\text{C}$ , typical) $\pm \{1.0\% + 30 \text{ mV} + (I_{dc}[\text{mA}] \times 4 \Omega)[\text{mV}]\}$ ( $5^\circ\text{C}$ to $40^\circ\text{C}$ , typical)
Current monitor accuracy	$\pm \{0.5\% + 30 \mu\text{A} + (V_{dc}[\text{V}] / 40 \text{ k}\Omega)[\text{mA}]\}$ ( $23 \pm 5^\circ\text{C}$ , typical) $\pm \{1.0\% + 60 \mu\text{A} + (V_{dc}[\text{V}] / 20 \text{ k}\Omega)[\text{mA}]\}$ ( $5^\circ\text{C}$ to $40^\circ\text{C}$ , typical)

**NOTE**

V<sub>dc</sub>: dc voltage bias monitor reading value [mV]  
 I<sub>dc</sub>: dc current bias monitor reading value [mA]

## Probe Station Connection Kit (Option 010)

### Oscillator Level

#### Power Accuracy

Frequency $\leq$ 1 GHz	$\pm 5.5$ dB (5°C to 40°C)
Frequency $>$ 1 GHz	$\pm 7.6$ dB (5°C to 40°C)



## Sweep Characteristics

### Sweep Conditions

Sweep parameters	Frequency, Oscillator level (power, voltage, current), DC bias voltage, DC bias current
Sweep range setup	Start/Stop or Center/Span
Sweep types	
Frequency sweep	Linear, Log, Segment
Other parameters' sweep	Linear
Sweep mode	Continuous, Single
Sweep directions	Up sweep, Down sweep
Number of measurement points	2 to 801
Delay time	
Types	Point delay, Sweep delay, Segment delay
Range	0 to 20 sec
Resolution	1 msec

### Segment Sweep

Available setup parameters for each segment	Sweep frequency range, number of measurement points, Point averaging factor, Oscillator level (power, voltage, or current), DC bias (voltage or current), DC bias limit (current limit for voltage bias, voltage limit for current bias)
Number of segments	1 to 16
Sweep span types	Frequency base or Order base

## Measurement Accuracy

**NOTE**

The following information is also applicable to the measurement accuracy of E4991A Option 010.

### Conditions for Defining Accuracy

Temperature	23 ±5°C
Calibration plane	7-mm connector of test head
Measurement frequency points	Same as calibration points.

### Accuracy When Open/Short/Load Calibration is Performed

$ Z ,  Y $	$\pm(E_a + E_b)$ [%] (see Figure 11-1 through Figure 11-4 for examples of calculated accuracy)
$\theta$	$\pm \frac{(E_a + E_b)}{100}$ [rad]
L, C, X, B	$\pm(E_a + E_b) \times \sqrt{(1 + D_x^2)}$ [%]
R, G	$\pm(E_a + E_b) \times \sqrt{(1 + Q_x^2)}$ [%]
D	
at $\left  D_x \tan\left(\frac{E_a + E_b}{100}\right) \right  < 1$	$\pm \frac{(1 + D_x^2) \tan\left(\frac{E_a + E_b}{100}\right)}{1 \mp D_x \tan\left(\frac{E_a + E_b}{100}\right)}$
at $D_x \leq 0.1$	$\pm \frac{E_a + E_b}{100}$
Q	
at $\left  Q_x \tan\left(\frac{E_a + E_b}{100}\right) \right  < 1$	$\pm \frac{(1 + Q_x^2) \tan\left(\frac{E_a + E_b}{100}\right)}{1 \mp Q_x \tan\left(\frac{E_a + E_b}{100}\right)}$
at $\frac{10}{E_a + E_b} \geq Q_x \geq 10$	$\pm Q_x^2 \frac{E_a + E_b}{100}$

**Accuracy When Open/Short/Load/Low-Loss Capacitor Calibration is Performed (point averaging factor  $\geq 8$ , typical)**

$ Z ,  Y $	$\pm(E_a + E_b)$ [%]
$\theta$	$\pm \frac{E_c}{100}$ [rad]
L, C, X, B	$\pm \sqrt{(E_a + E_b)^2 + (E_c D_x)^2}$ [%]
R, G	$\pm \sqrt{(E_a + E_b)^2 + (E_c Q_x)^2}$ [%]
D	
at $\left  D_x \tan\left(\frac{E_c}{100}\right) \right  < 1$	$\pm \frac{(1 + D_x^2) \tan\left(\frac{E_c}{100}\right)}{1 \mp D_x \tan\left(\frac{E_c}{100}\right)}$
at $D_x \leq 0.1$	$\pm \frac{E_c}{100}$
Q	
at $\left  Q_x \tan\left(\frac{E_c}{100}\right) \right  < 1$	$\pm \frac{(1 + Q_x^2) \tan\left(\frac{E_c}{100}\right)}{1 \mp Q_x \tan\left(\frac{E_c}{100}\right)}$
at $\frac{10}{E_c} \geq Q_x \geq 10$	$\pm Q_x^2 \frac{E_c}{100}$

(see Figure 11-5)

**Definition of Each Parameter**

Dx =	Measurement value of D
Qx =	Measurement value of Q
Ea =	(Within $\pm 5^\circ\text{C}$ of calibration temperature. Measurement accuracy applies when calibration is performed at $23^\circ\text{C} \pm 5^\circ\text{C}$ . When calibration is performed beyond $23^\circ\text{C} \pm 5^\circ\text{C}$ , measurement error doubles.)
at Oscillator level $\geq -33$ dBm	$\pm 0.65$ [%] (1 MHz $\leq$ Frequency $\leq$ 100 MHz) $\pm 0.8$ [%] (100 MHz < Frequency $\leq$ 500 MHz) $\pm 1.2$ [%] (500 MHz < Frequency $\leq$ 1 GHz) $\pm 2.5$ [%] (1 GHz < Frequency $\leq$ 1.8 GHz) $\pm 5$ [%] (1.8 GHz < Frequency $\leq$ 3 GHz)

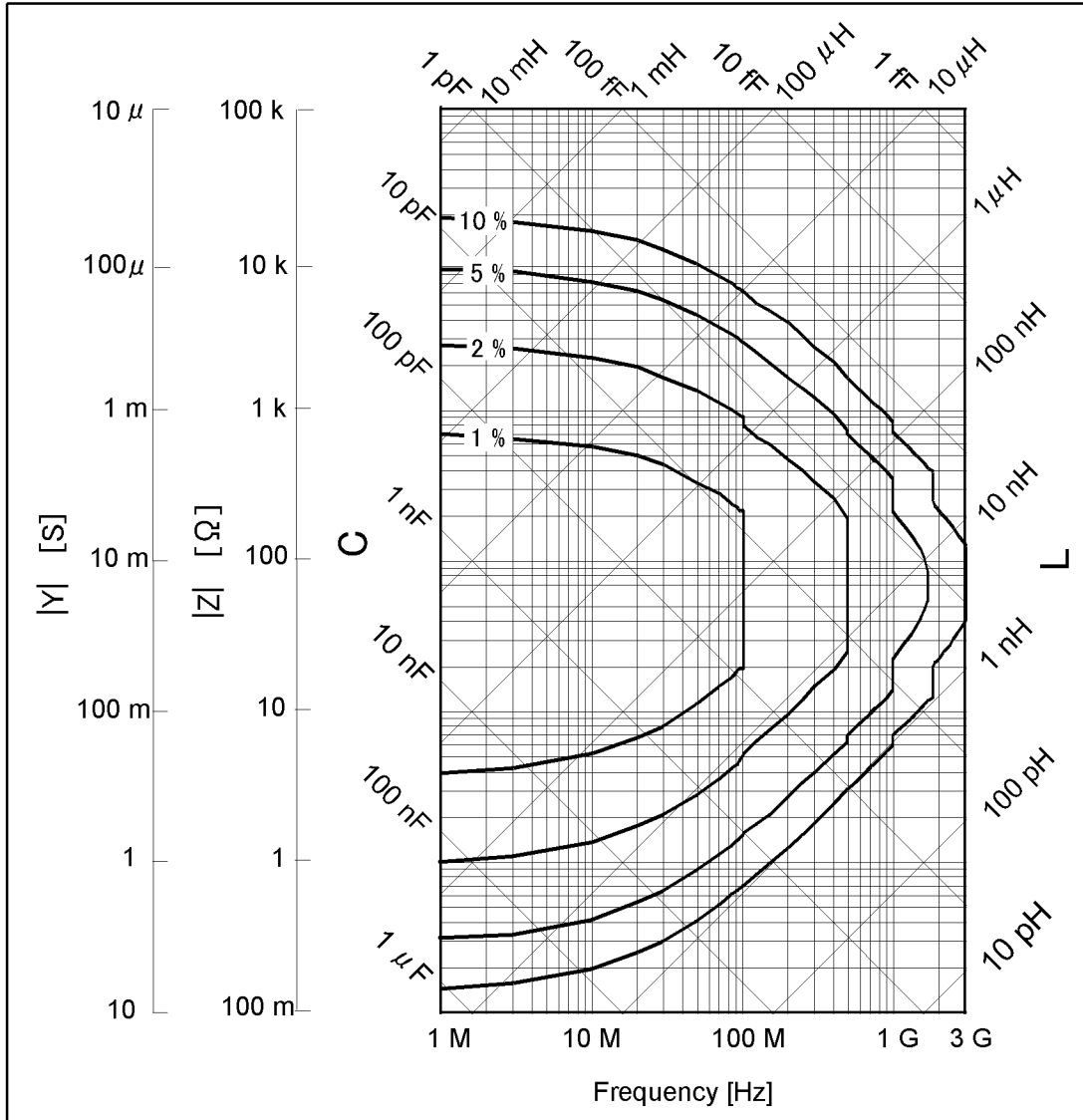
Specifications and Supplemental Information  
**Measurement Accuracy**

at Oscillator level < -33 dBm	$\pm 1$ [%] (1 MHz $\leq$ Frequency $\leq$ 100 MHz) $\pm 1.2$ [%] (100 MHz < Frequency $\leq$ 500 MHz) $\pm 1.2$ [%] (500 MHz < Frequency $\leq$ 1 GHz) $\pm 2.5$ [%] (1 GHz < Frequency $\leq$ 1.8 GHz) $\pm 5$ [%] (1.8 GHz < Frequency $\leq$ 3 GHz)
Eb =	$\pm \left( \frac{Z_s}{ Z_x } + Y_o \cdot  Z_x  \right) \times 100$ [%] ( Zx : Measurement value of  Z )
Ec =	$\pm \left( 0.06 + \frac{0.08 \times F}{1000} \right)$ [%] (F: Frequency [MHz], typical)
Zs =	(Within $\pm 5^\circ\text{C}$ of calibration temperature. Measurement accuracy applies when calibration is performed at $23^\circ\text{C} \pm 5^\circ\text{C}$ . When calibration is performed beyond $23^\circ\text{C} \pm 5^\circ\text{C}$ , measurement error doubles. F: Frequency [MHz].)
at Oscillator level = -3 dBm, -13 dBm, or -23 dBm	$\pm (13 + 0.5 \times F)$ [m $\Omega$ ] (Point averaging factor $\geq 8$ ) $\pm (25 + 0.5 \times F)$ [m $\Omega$ ] (Point averaging factor $\leq 7$ )
at Oscillator level $\geq -33$ dBm	$\pm (25 + 0.5 \times F)$ [m $\Omega$ ] (Point averaging factor $\geq 8$ ) $\pm (50 + 0.5 \times F)$ [m $\Omega$ ] (Point averaging factor $\leq 7$ )
at Oscillator level < -33 dBm	$\pm (50 + 0.5 \times F)$ [m $\Omega$ ] (Point averaging factor $\geq 8$ ) $\pm (100 + 0.5 \times F)$ [m $\Omega$ ] (Point averaging factor $\leq 7$ )
Yo =	(Within $\pm 5^\circ\text{C}$ of calibration temperature. Measurement accuracy applies when calibration is performed at $23^\circ\text{C} \pm 5^\circ\text{C}$ . When calibration is performed beyond $23^\circ\text{C} \pm 5^\circ\text{C}$ , measurement error doubles. F: Frequency [MHz].)
at Oscillator level = -3 dBm, -13 dBm, -23 dBm	$\pm (5 + 0.1 \times F)$ [ $\mu\text{S}$ ] (Point averaging factor $\geq 8$ ) $\pm (10 + 0.1 \times F)$ [ $\mu\text{S}$ ] (Point averaging factor $\leq 7$ )
at Oscillator level $\geq -33$ dBm	$\pm (10 + 0.1 \times F)$ [ $\mu\text{S}$ ] (Point averaging factor $\geq 8$ ) $\pm (30 + 0.1 \times F)$ [ $\mu\text{S}$ ] (Point averaging factor $\leq 7$ )
at Oscillator level < -33 dBm	$\pm (20 + 0.1 \times F)$ [ $\mu\text{S}$ ] (Point averaging factor $\geq 8$ ) $\pm (60 + 0.1 \times F)$ [ $\mu\text{S}$ ] (Point averaging factor $\leq 7$ )

### Calculated Impedance Measurement Accuracy

Figure 11-1

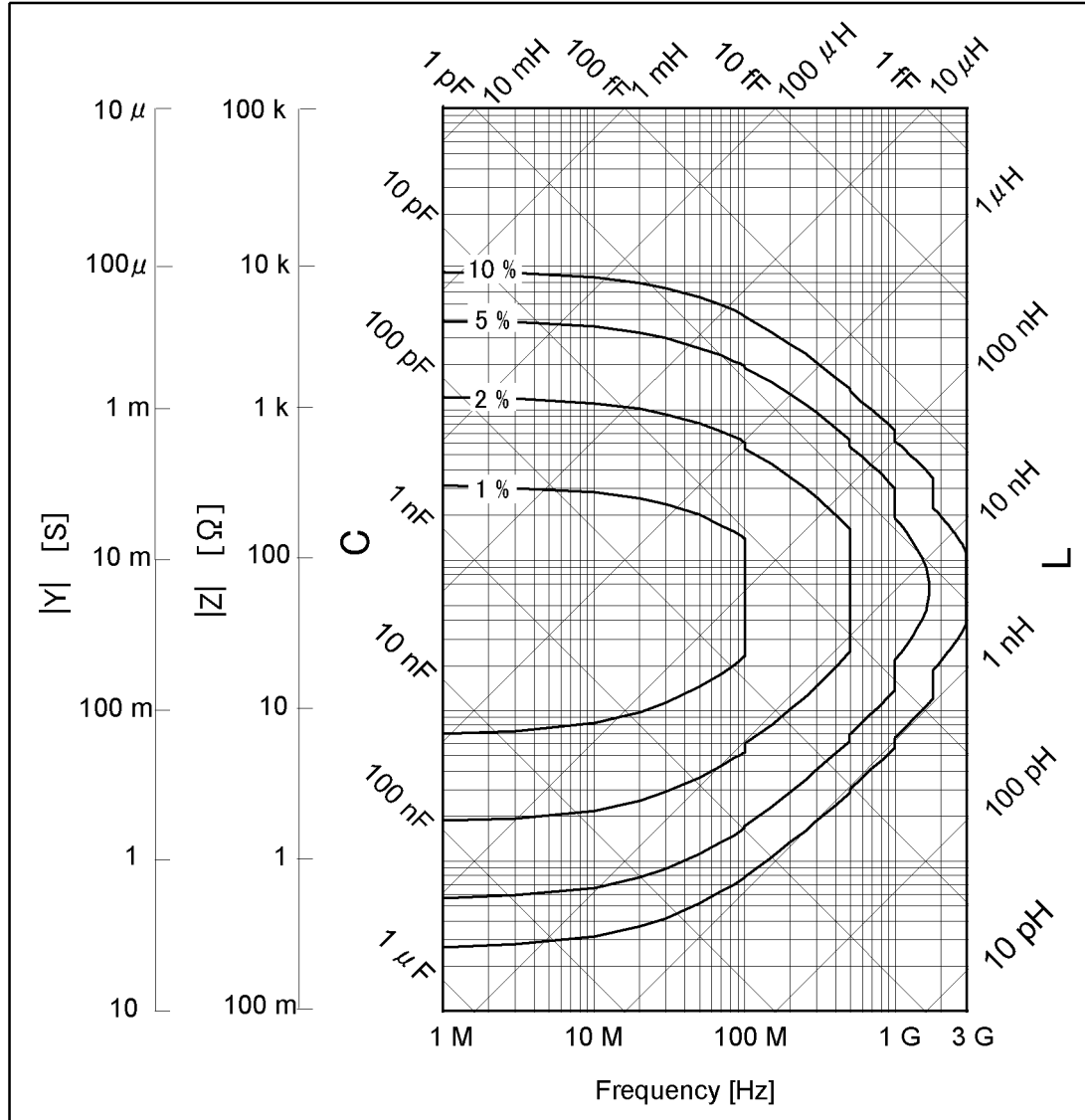
$|Z|$ ,  $|Y|$  Measurement Accuracy When Open/Short/Load Calibration is Performed  
 Oscillator level = -23 dBm, -13 dBm, -3 dBm  
 Point averaging factor  $\geq 8$   
 within  $\pm 5^\circ\text{C}$  of calibration temperature



E4991a0e801

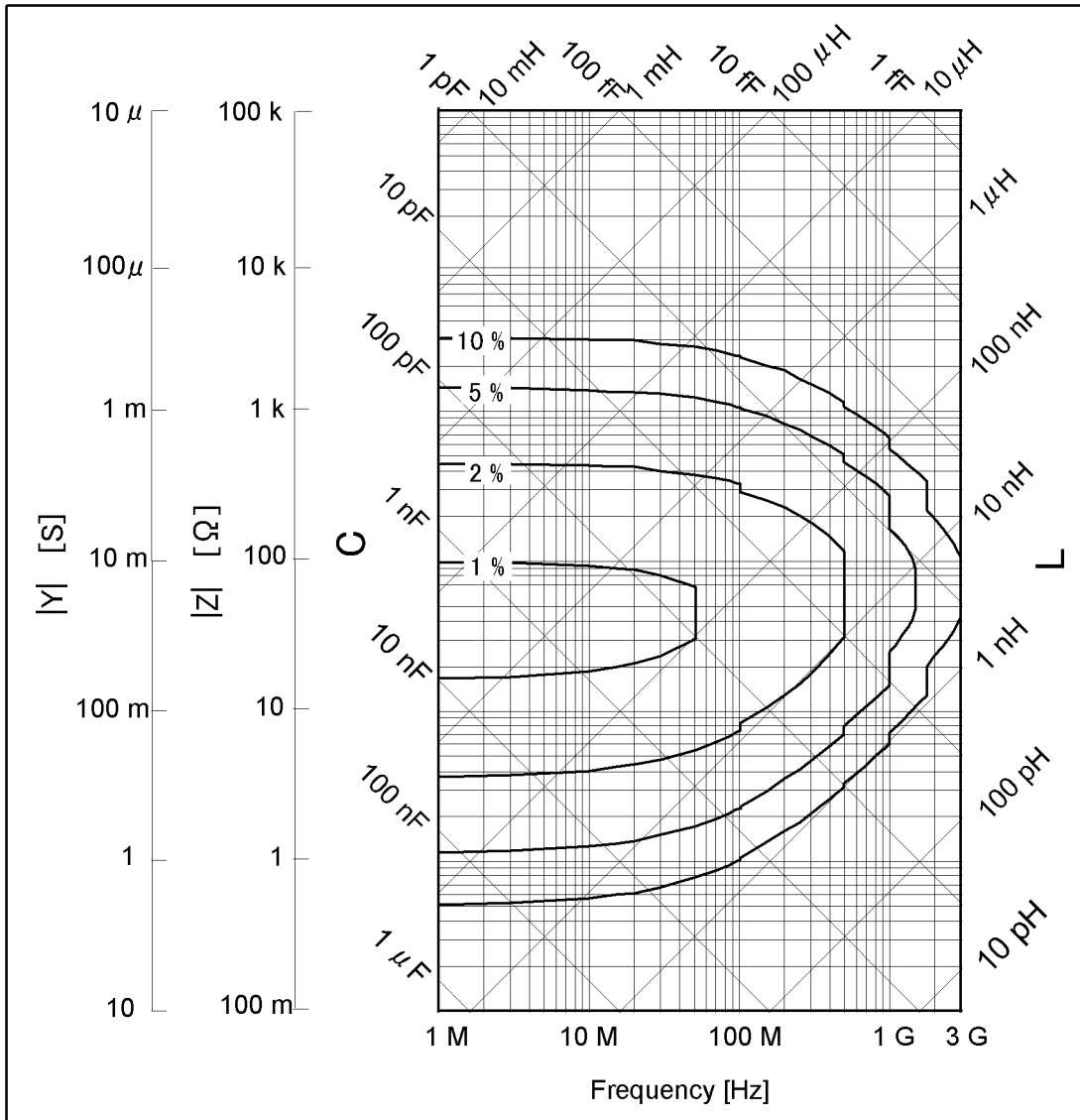
Figure 11-2

**$|Z|$ ,  $|Y|$  Measurement Accuracy When Open/Short/Load Calibration is Performed**  
**Oscillator level  $\geq -33$  dBm**  
**Point averaging factor  $\geq 8$**   
**within  $\pm 5^\circ\text{C}$  of calibration temperature**



E4991a0e802

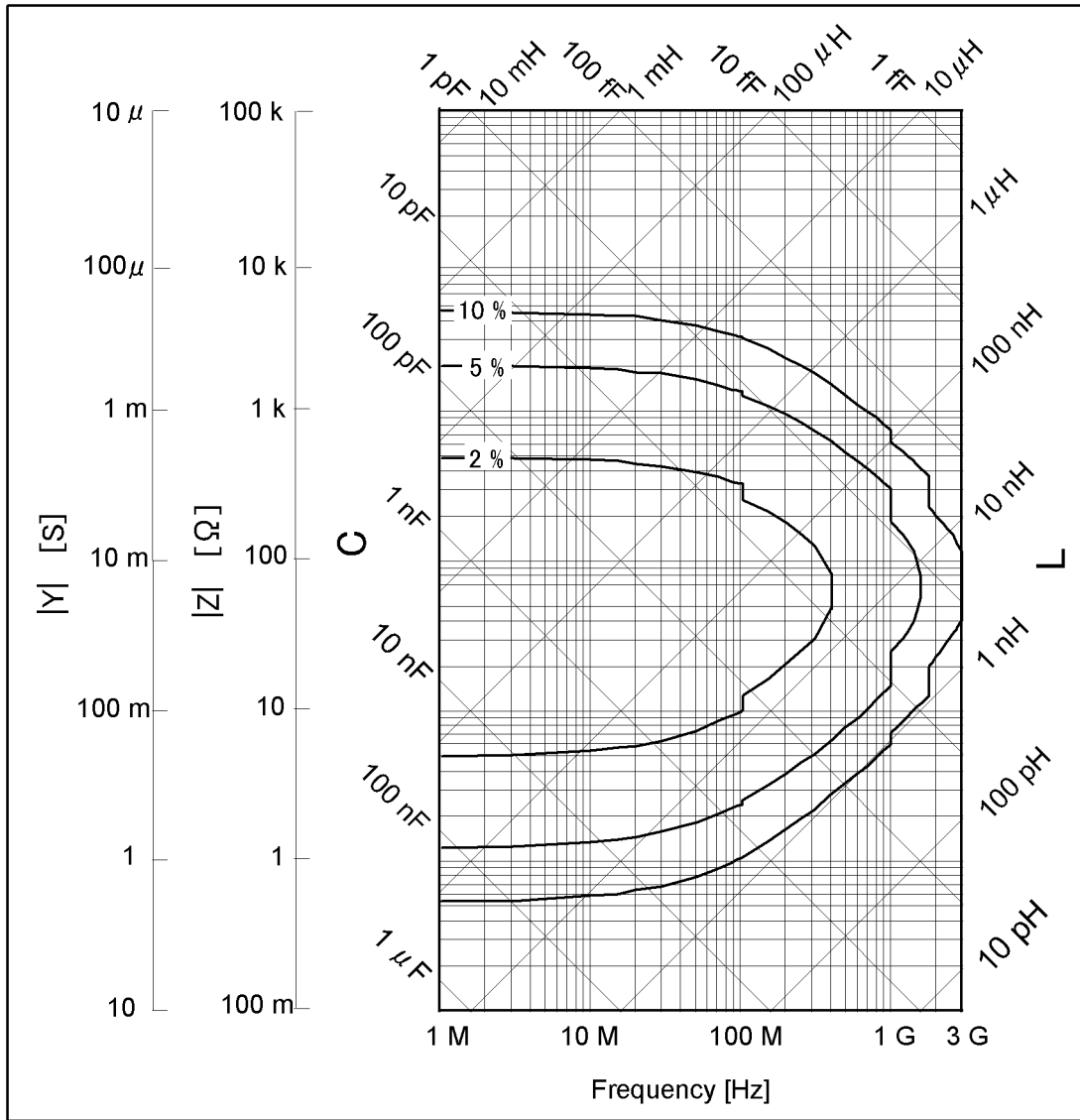
**Figure 11-3**  $|Z|$ ,  $|Y|$  Measurement Accuracy When Open/Short/Load Calibration is Performed  
 Oscillator level  $\geq -33$  dBm  
 Point averaging factor  $\leq 7$   
 within  $\pm 5^\circ\text{C}$  of calibration temperature



E4991a0e803

Figure 11-4

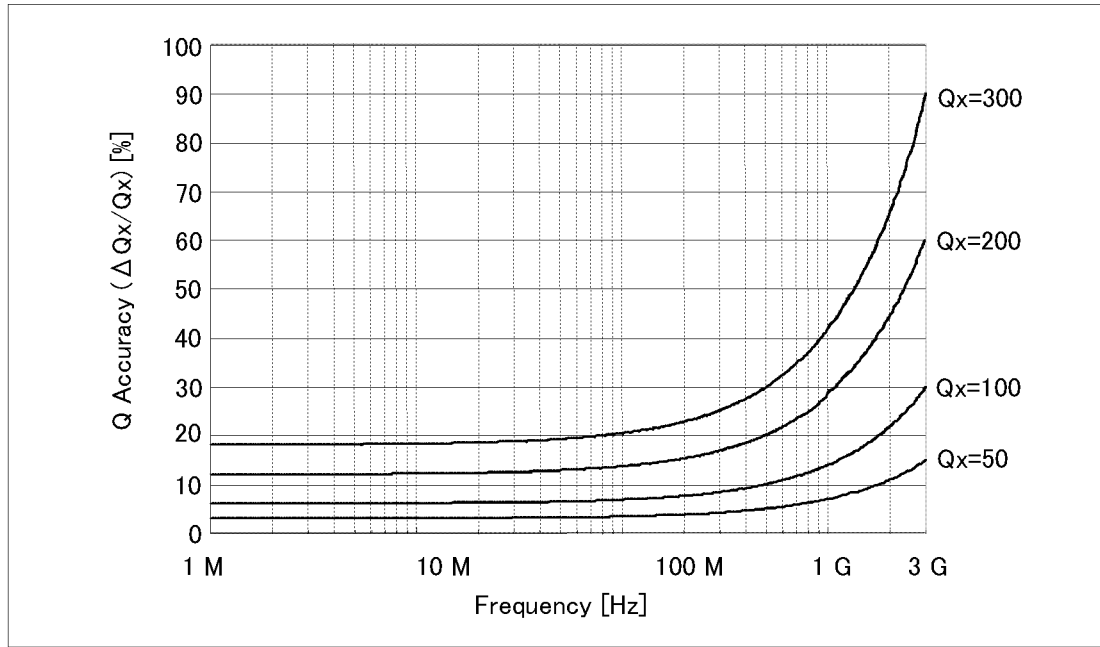
**$|Z|$ ,  $|Y|$  Measurement Accuracy When Open/Short/Load Calibration is Performed**  
**Oscillator level  $< -33$  dBm**  
**within  $\pm 5^\circ\text{C}$  of calibration temperature**



E4991a0e804



Figure 11-5 Q Measurement Accuracy When Open/Short/Load/Low-Loss Capacitor Calibration is Performed (typical)



E4991a0e830

## Measurement Support Functions

### Error Correction

---

#### Available calibration and compensation

---

Open/Short/Load Calibration	Connect open, short, and load standards to the desired reference plane and measure each kind of calibration data. The reference plane is called the calibration reference plane.
Low-Loss Capacitor Calibration	Connect the dedicated standard (low-loss capacitor) to the calibration reference plane and measure the calibration data.
Port Extension Compensation (fixture selection)	When a device is connected to a terminal that is extended from the calibration reference plane, set the electrical length between the calibration plane and the device contact. Select the model number of the registered test fixtures in the E4991A's setup toolbar or enter the electrical length for a user's test fixture.
Open/Short Compensation	When a device is connected to a terminal that is extended from the calibration reference plane, make open and/or short states at the device contact and measure each kind of compensation data.

#### Calibration/Compensation data measurement point

---

User-defined point mode	Obtain calibration/compensation data at the same frequency and power points as used in actual device measurement, which are determined by the sweep setups. Each set of calibration/compensation data is applied to each measurement at the same point. If measurement points (frequency and/or power) are changed by altering the sweep setups, calibration/compensation data become invalid and calibration or compensation data acquisition is again required.
Fixed frequency and fixed power point mode	Obtain calibration/compensation data at fixed frequency and power points covering the entire frequency and power range of the E4991A. In device measurement, calibration or compensation is applied to each measurement point by using interpolation. Even if the measurement points (frequency and/or power) are changed by altering the sweep setups, you don't need to retake the calibration or compensation data.
Fixed frequency and user-defined power point mode	Obtain calibration/compensation data at fixed frequency points covering the entire frequency range of the E4991A and at the same power points as used in actual device measurement which are determined by the sweep setups. Calibration/compensation data become invalid only if the power points are changed, in which case calibration or compensation data would need to be acquired again.

## **Trigger**

---

Trigger mode Internal, External (external trigger input connector), Bus (GPIB), Manual (front key)

## **Averaging**

---

Types Sweep-to-sweep averaging, Point averaging

Setting range

Sweep-to-sweep averaging 1 to 999 (integer)

Point averaging 1 to 100 (integer)

## **Display**

---

LCD display

Type/Size Color LCD, 8.4 inch (21.3 cm)

Resolution 640 (horizontal) × 480 (vertical)

Number of traces

Data trace 3 scalar traces + 2 complex traces (maximum)

Memory trace 3 scalar traces + 2 complex traces (maximum)

Trace data math Data – Memory, Data/Memory (for complex parameters), Delta% (for scalar parameters), offset

Format

For scalar parameters Linear Y-axis, Log Y-axis

For complex parameters Z, Y: Polar, Complex;  
 Γ: Polar, Complex, Smith, Admittance

Other display functions Split/Overlay display (for scalar parameters), Phase expansion

## **Marker**

---

Number of markers	
Marker	Eight for each trace (Marker 1 - Marker 8)
Reference marker	One for each trace (Marker R)
Marker search	
Search type	Maximum, Minimum, Target, Peak
Search track	Performs search with each sweep
Other functions	Marker continuous mode, Marker coupled mode, Marker list, Marker statistics

## **Equivalent Circuit Analysis**

---

Circuit models	3-component model (4 models), 4-component model (1 model)
Analysis types	Equivalent circuit parameters calculation, frequency characteristics simulation

## **Limit Marker Test**

---

Number of markers for limit test	9 (Marker R, Markers 1 to 8)
Setup parameters for each marker	Stimulus value, upper limit, and lower limit

## **Mass Storage**

---

Built-in flexible (floppy) disk drive	3.5 inch, 720 KByte or 1.44 MByte, DOS format
Hard disk drive	2 GByte (minimum)
Stored data	State (binary), Measurement data (binary, ASCII, or CITIfile), Display graphics (bmp, jpg), VBA program (binary)

## Interface

---

### GPIB

---

Standard conformity	IEEE 488.1-1987, IEEE 488.2-1987
Available functions (function code)* <sup>1</sup>	SH1, AH1, T6, TE0, L4, LE0, SR1, RL0, PP0, DT1, DC1, C0, E2
Numerical data transfer format	ASCII
Protocol	IEEE 488.2-1987

\*1. Refer to the standard for the meaning of each function code.

### Printer parallel port

---

Interface standard	IEEE 1284 Centronics
Connector type	25-pin D-sub connector, female

### LAN interface

---

Standard conformity	10 Base-T or 100 Base-TX (automatically switched), Ethertwist, RJ45 connector
Protocol	TCP/IP
Functions	FTP

### USB Port

---

Interface standard	USB1.1
Connector type	Standard USB A, female
Available function	Connection to printers and USB/GPIB Interface

### Measurement Terminal (at Test Head)

---

Connector type	7-mm connector
----------------	----------------

## Rear Panel Connectors

---

### External reference signal input connector

---

Frequency	10 MHz $\pm$ 10 ppm (typical)
Level	0 to +6 dBm (typical)
Input impedance	50 $\Omega$ (nominal)
Connector type	BNC, female

Specifications and Supplemental Information  
**Measurement Support Functions**

**Internal reference signal output connector**

---

Frequency	10 MHz (nominal)
Accuracy of frequency	Same as frequency accuracy described in “Frequency” on page 239
Level	+2 dBm (nominal)
Output impedance	50 $\Omega$ (nominal)
Connector type	BNC, female

**High stability frequency reference output connector (option 1D5)**

---

Frequency	10 MHz (nominal)
Accuracy of frequency	Same as frequency accuracy described in “Frequency” on page 239
Level	+2 dBm (nominal)
Output impedance	50 $\Omega$ (nominal)
Connector type	BNC, female

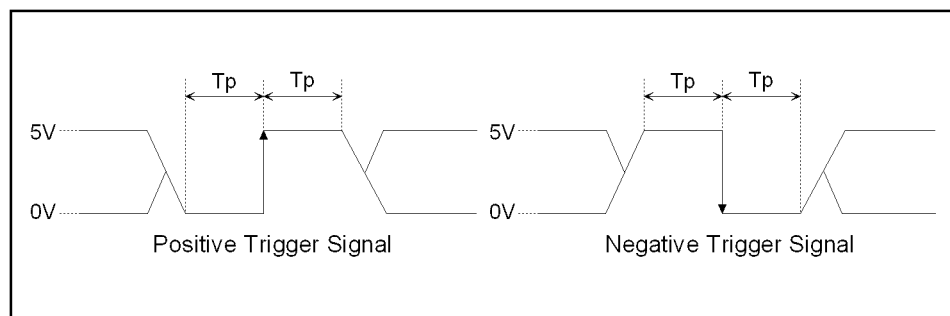
**External trigger input connector**

---

Level	LOW threshold voltage: 0.5 V HIGH threshold voltage: 2.1 V Input level range: 0 to +5 V
Pulse width ( $T_p$ )	$\geq 2 \mu\text{sec}$ (typical) See Figure 11-6 for definition of $T_p$
Polarity	Positive or Negative (selective)
Connector type	BNC, female

**Figure 11-6**

**Definition of Pulse Width ( $T_p$ )**



C5010014e

---

## General Characteristics

### Environment Conditions

---

#### Operating condition

---

Temperature	5°C to 40°C
Humidity (at wet bulb temperature $\leq 29^{\circ}\text{C}$ , without condensation)	
Flexible disk drive non-operating condition	15% to 90% RH
Flexible disk drive operating condition	20% to 80% RH
Altitude	0 to 2,000 m (0 to 6,561 feet)
Vibration	0.5 G maximum, 5 Hz to 500 Hz
Warm-up time	30 minutes

#### Non-operating storage condition

---

Temperature	$-20^{\circ}\text{C}$ to $+60^{\circ}\text{C}$
Humidity (at wet bulb temperature $\leq 45^{\circ}\text{C}$ , without condensation)	15% to 90% RH
Altitude	0 to 4,572 m (0 to 15,000 feet)
Vibration	1 G maximum, 5 Hz to 500 Hz

## Other Specifications

---

### EMC

---



European Council Directive 89/336/EEC  
IEC 61326-1:1997+A1  
CISPR 11:1990 / EN 55011:1991 Group 1, Class A  
IEC 61000-4-2:1995 / EN 61000-4-2:1995  
4 kV CD / 4 kV AD  
IEC 61000-4-3:1995 / EN 61000-4-3:1996  
3 V/m, 80-1000 MHz, 80% AM  
IEC 61000-4-4:1995 / EN 61000-4-4:1995  
1 kV power / 0.5 kV Signal  
IEC 61000-4-5:1995 / EN 61000-4-5:1995  
0.5 kV Normal / 1 kV Common  
IEC 61000-4-6:1996 / EN 61000-4-6:1996  
3 V, 0.15-80 MHz, 80% AM  
IEC 61000-4-11:1994 / EN 61000-4-11:1994  
100% 1cycle  
Note: When tested at 3 V/m according to EN  
61000-4-3:1996, the measurement accuracy will be within  
specifications over the full immunity test frequency range of  
80 to 1000 MHz except when the analyzer frequency is  
identical to the transmitted interference signal test frequency.

### ICES/NMB-001

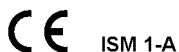
This ISM device complies with Canadian ICES-001.  
Cet appareil ISM est conforme à la norme NMB-001 du  
Canada.



AS/NZS 2064.1/2 Group 1, Class A

### Safety

---



European Council Directive 73/23/EEC  
IEC 61010-1:1990+A1+A2 / EN 61010-1:1993+A2  
INSTALLATION CATEGORY II, POLLUTION  
DEGREE 2  
INDOOR USE  
IEC60825-1:1994 CLASS 1 LED PRODUCT



CAN/CSA C22.2 No. 1010.1-92



**Environment**



This product complies with the WEEE Directive (2002/96/EC) marking requirements. The affixed label indicates that you must not discard this electrical/ electronic product in domestic household waste.

Product Category : With reference to the equipment types in the WEEE Directive Annex I, this product is classed as a “Monitoring and Control instrumentation” product.

Do not dispose in domestic household waste.

To return unwanted products, contact your local Agilent office, or see [www.agilent.com/environment/product/](http://www.agilent.com/environment/product/) for more information.

**Power requirements**

Power requirements 90 V to 132 V, or 198 V to 264 V (automatically switched), 47 Hz to 63 Hz, 350 VA maximum

**Weight**

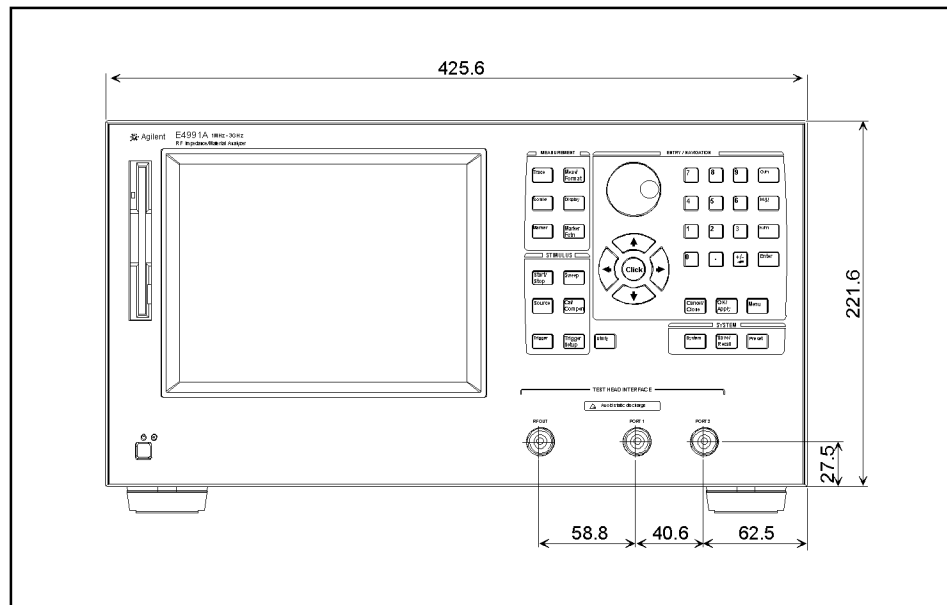
Main unit 17 kg (nominal)  
 Test head 1 kg (nominal)

**Dimensions**

Main unit see Figure 11-7 through Figure 11-9.  
 Test head see Figure 11-10.

**Figure 11-7**

**Main Unit Dimensions (front view, in millimeters, nominal)**



e4991a0e806

Figure 11-8 Main Unit Dimensions (rear view, in millimeters, nominal)

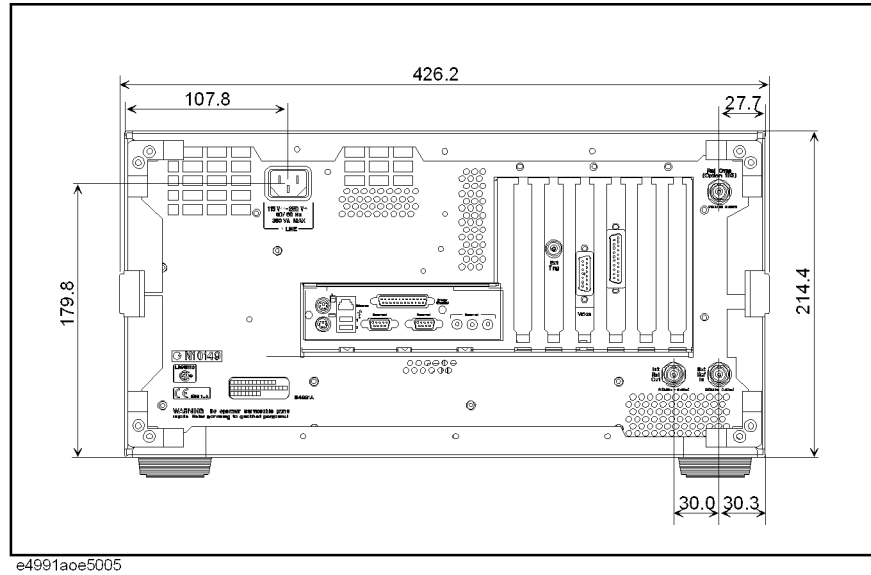
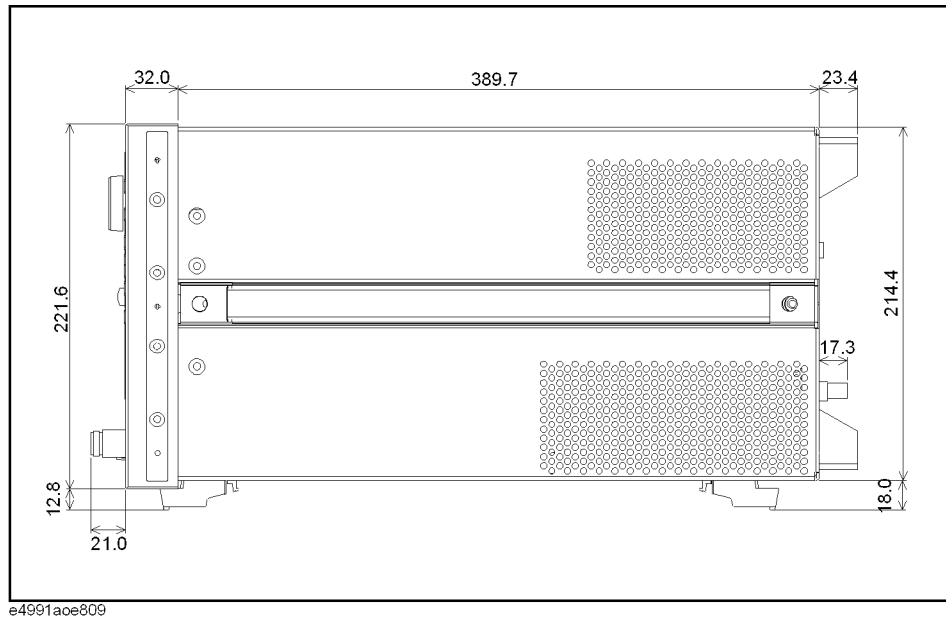
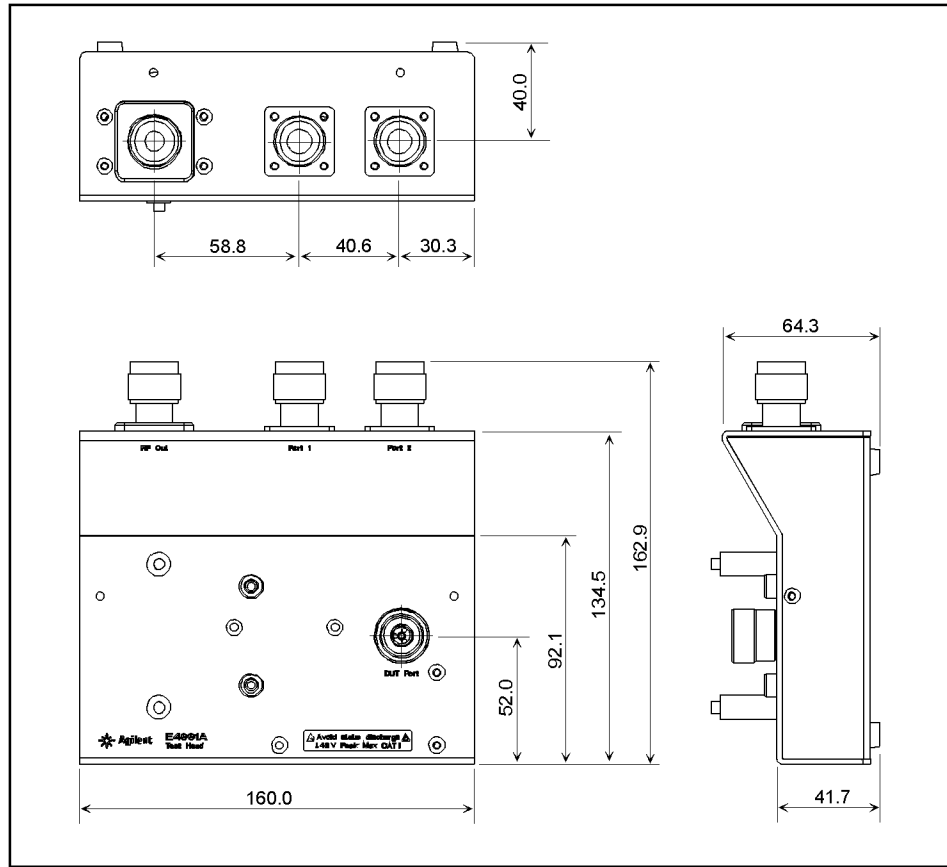


Figure 11-9 Main Unit Dimensions (side view, in millimeters, nominal)



**Figure 11-10**

**Direct Connection Type Test Head Dimensions (in millimeters, nominal)**



e4991ace808

Figure 11-11

Option 010 Test Head Dimensions (in millimeters, nominal)

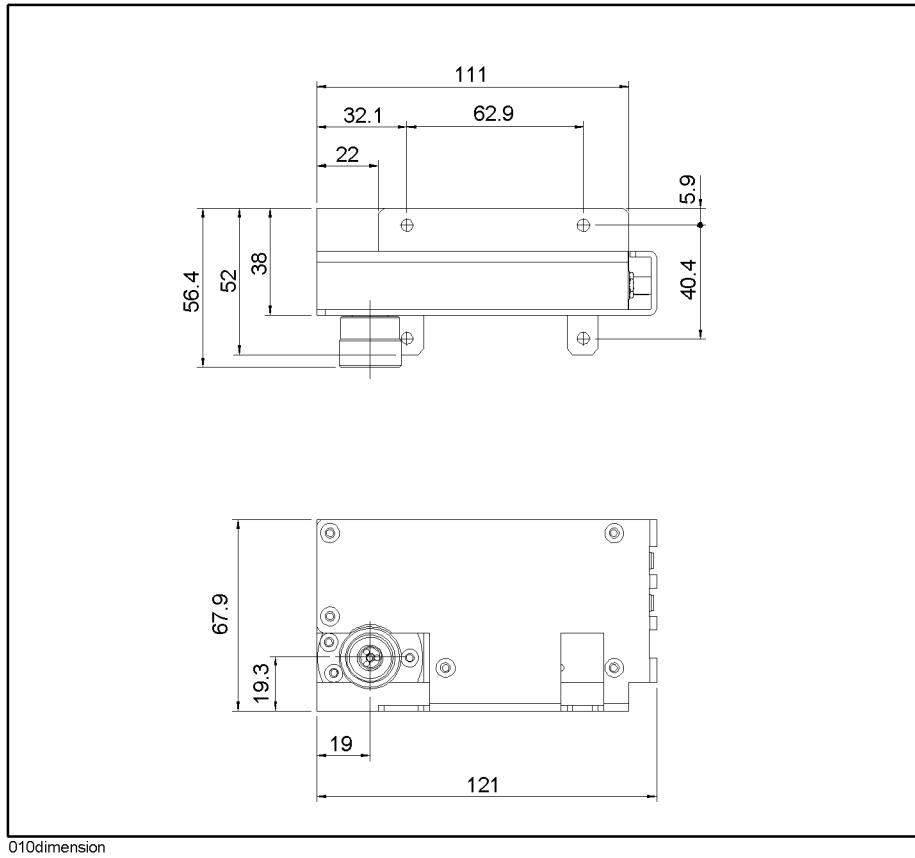
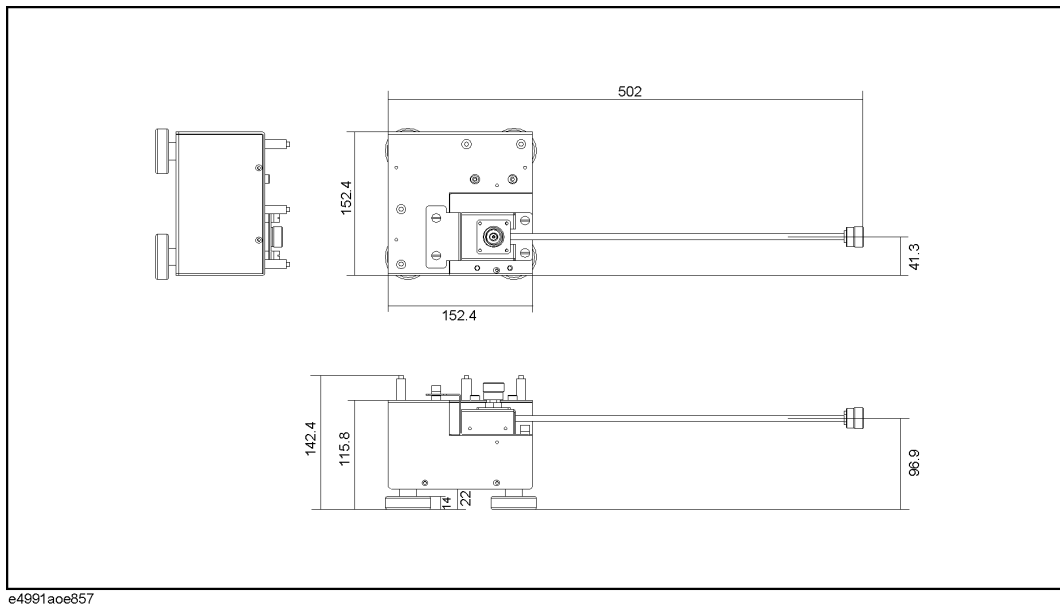


Figure 11-12

Option 007 Test Head Dimensions (in millimeters, nominal)



## Option 002 Material Measurement (typical)

### Measurement Parameter

Permittivity parameters	$ \epsilon_r , \epsilon'_r, \epsilon''_r, \tan \delta$
Permeability parameters	$ \mu_r , \mu'_r, \mu''_r, \tan \delta$

### Frequency Range

Use with Agilent 16453A	1 MHz to 1 GHz (typical)
Use with Agilent 16454A	1 MHz to 1 GHz (typical)

### Measurement Accuracy

#### Conditions

Calibration	Open, Short, and Load calibration at the test port (7-mm connector)
Calibration temperature	Calibration is performed at an environmental temperature within the range of $23^\circ\text{C} \pm 5^\circ\text{C}$ . Measurement error doubles when calibration temperature is below $18^\circ\text{C}$ or above $28^\circ\text{C}$ .
Measurement temperature range	Within $\pm 5^\circ\text{C}$ of calibration temperature
temperature	Measurement accuracy applies when calibration is performed at $23^\circ\text{C} \pm 5^\circ\text{C}$ . When calibration is below $18^\circ\text{C}$ or above $23^\circ\text{C}$ , measurement error doubles.
Measurement plane	Same as calibration plane
Measurement frequency points	Same as calibration points
Oscillator level	Same as the level set at calibration
Point averaging factor	$\geq 8$
Electrode pressure setting of 16453A	Maximum

**Typical accuracy of permittivity parameters**

---

$$\begin{aligned} \epsilon_r' \text{ accuracy} & \pm \left[ 5 + \left( 10 + \frac{0.1}{f} \right) \frac{t}{\epsilon'_{rm}} + 0.25 \frac{\epsilon'_{rm}}{t} + \frac{100}{\left| 1 - \left( \frac{13}{f \sqrt{\epsilon'_{rm}}} \right)^2 \right|} \right] [\%] \\ \left( = \frac{\Delta \epsilon'_{rm}}{\epsilon'_{rm}} \right) & \\ & \text{(at } \tan \delta < 0.1 \text{)} \end{aligned}$$

$$\begin{aligned} \text{Loss tangent accuracy of } \epsilon_r' & \pm (E_a + E_b) \text{ (at } \tan \delta < 0.1 \text{)} \\ (= \Delta \tan \delta) & \end{aligned}$$

where,

$$E_a =$$

$$\text{at Frequency } \leq 1 \text{ GHz} \quad 0.002 + \frac{0.001}{f} \cdot \frac{t}{\epsilon'_{rm}} + 0.004f + \frac{0.1}{\left| 1 - \left( \frac{13}{f \sqrt{\epsilon'_{rm}}} \right)^2 \right|}$$

$$\text{at Frequency } > 1 \text{ GHz} \quad 0.002 + \frac{0.001}{f} \cdot \frac{t}{\epsilon'_{rm}} + 0.004f + \frac{1.1}{\left| 1 - \left( \frac{13}{f \sqrt{\epsilon'_{rm}}} \right)^2 \right|}$$

$$E_b = \left( \frac{\Delta \epsilon'_{rm}}{\epsilon'_{rm}} \cdot \frac{1}{100} + \epsilon'_{rm} \frac{0.002}{t} \right) \tan \delta$$

$$f = \text{Measurement frequency [GHz]}$$

$$t = \text{Thickness of MUT (material under test) [mm]}$$

$$\epsilon'_{rm} = \text{Measured value of } \epsilon_r'$$

$$\tan \delta = \text{Measured value of dielectric loss tangent}$$

**Typical accuracy of permeability parameters**

---

$\mu_r'$  accuracy  
 (=  $\frac{\Delta\mu'_{rm}}{\mu'_{rm}}$ )  $4 + \frac{0.02}{f} \times \frac{25}{F\mu'_{rm}} + F\mu'_{rm} \left(1 + \frac{15}{F\mu'_{rm}}\right)^2 f^2$  [%]  
 (at  $\tan\delta < 0.1$ )

Loss tangent accuracy of  $\mu_r$   
 (=  $\Delta \tan\delta$ )  $\pm(E_a + E_b)$  (at  $\tan\delta < 0.1$ )

where,

$E_a = 0.002 + \frac{0.001}{F\mu'_{rm}f} + 0.004f$

$E_b = \frac{\Delta\mu'_{rm}}{\mu'_{rm}} \bullet \frac{\tan\delta}{100}$

$f =$  Measurement frequency [GHz]

$F = h \ln \frac{c}{b}$  [mm]

$h =$  Height of MUT (material under test) [mm]

$b =$  Inner diameter of MUT (material under test) [mm]

$c =$  Outer diameter of MUT (material under test) [mm]

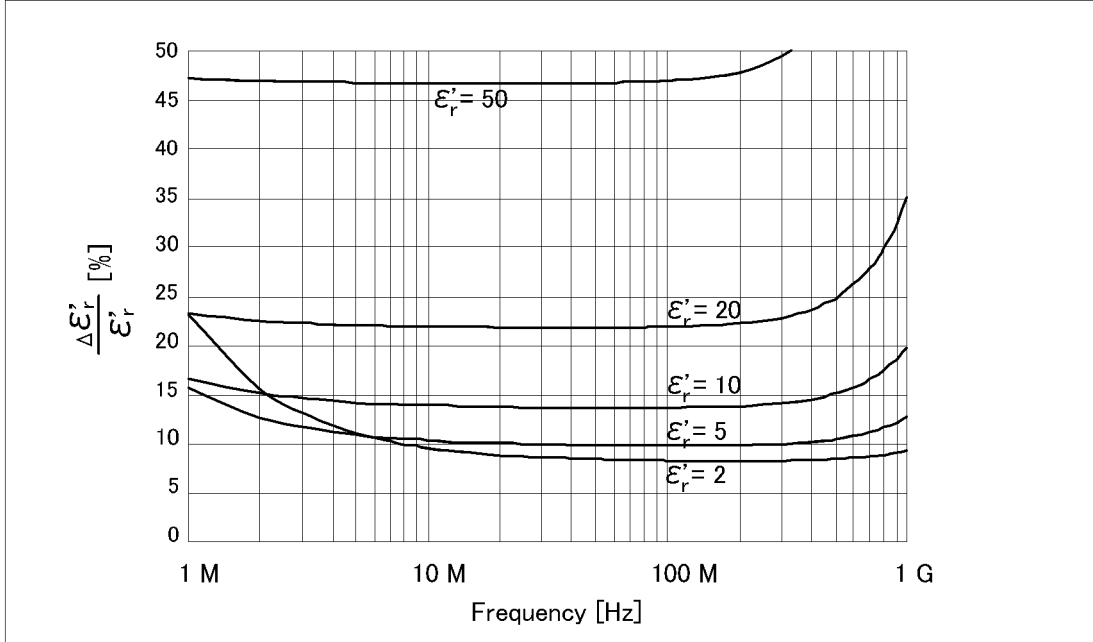
$\mu'_{rm} =$  Measured value of  $\mu_r'$

$\tan\delta =$  Measured value of loss tangent

**Examples of Calculated Permittivity Measurement Accuracy**

Figure 11-13

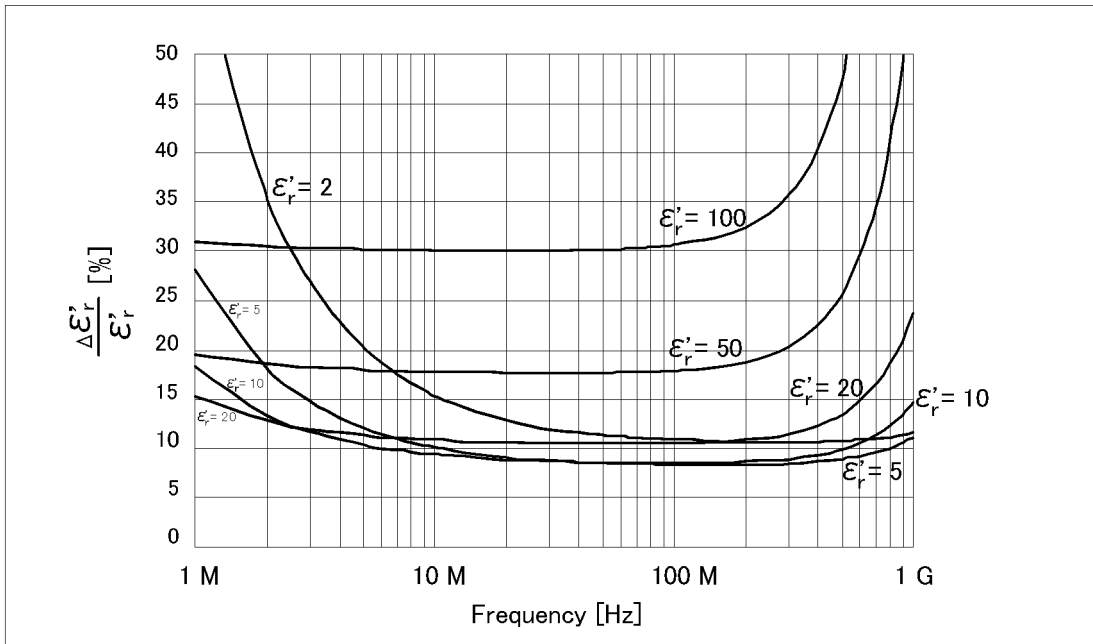
Permittivity Accuracy ( $\frac{\Delta\epsilon'_r}{\epsilon'_r}$ ) vs. Frequency (at  $t = 0.3$  mm, typical)



E4991a0e0811

Figure 11-14

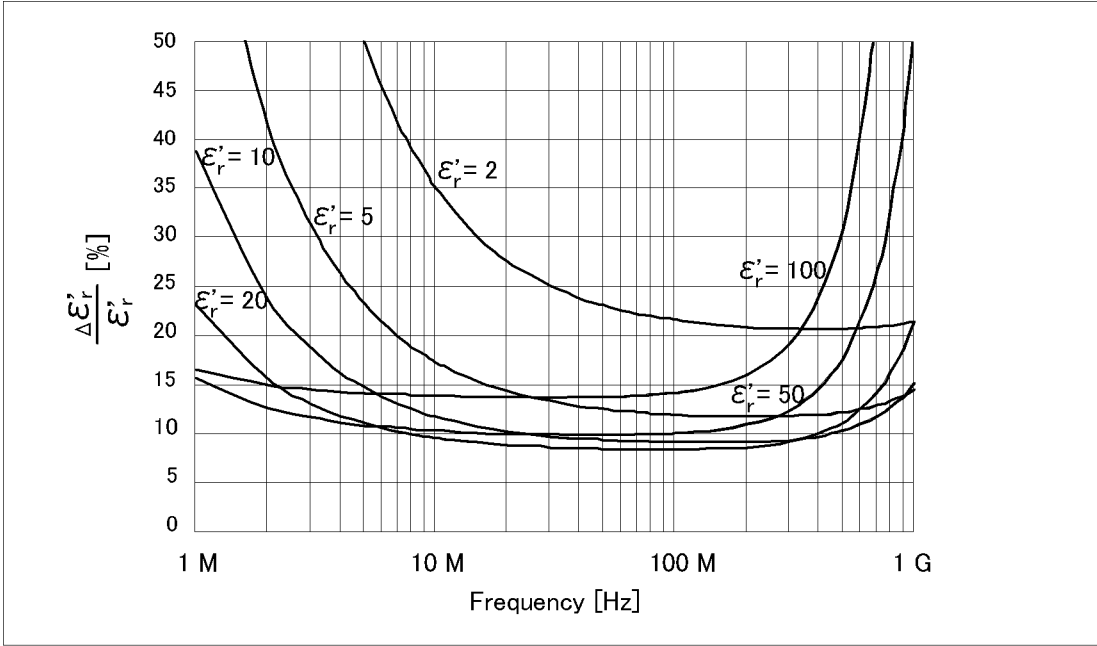
Permittivity Accuracy ( $\frac{\Delta\epsilon'_r}{\epsilon'_r}$ ) vs. Frequency (at  $t = 1$  mm, typical)



E4991a0e0812

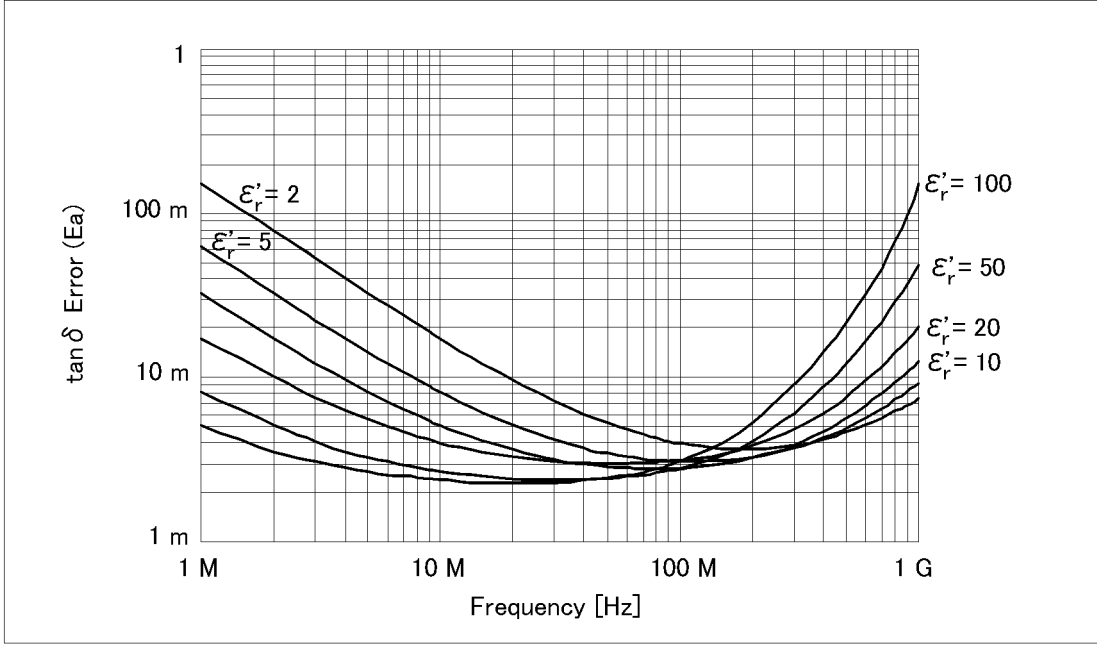


**Figure 11-15** Permittivity Accuracy ( $\frac{\Delta\epsilon'_r}{\epsilon'_r}$ ) vs. Frequency (at  $t = 3$  mm, typical)



E4991a0e0813

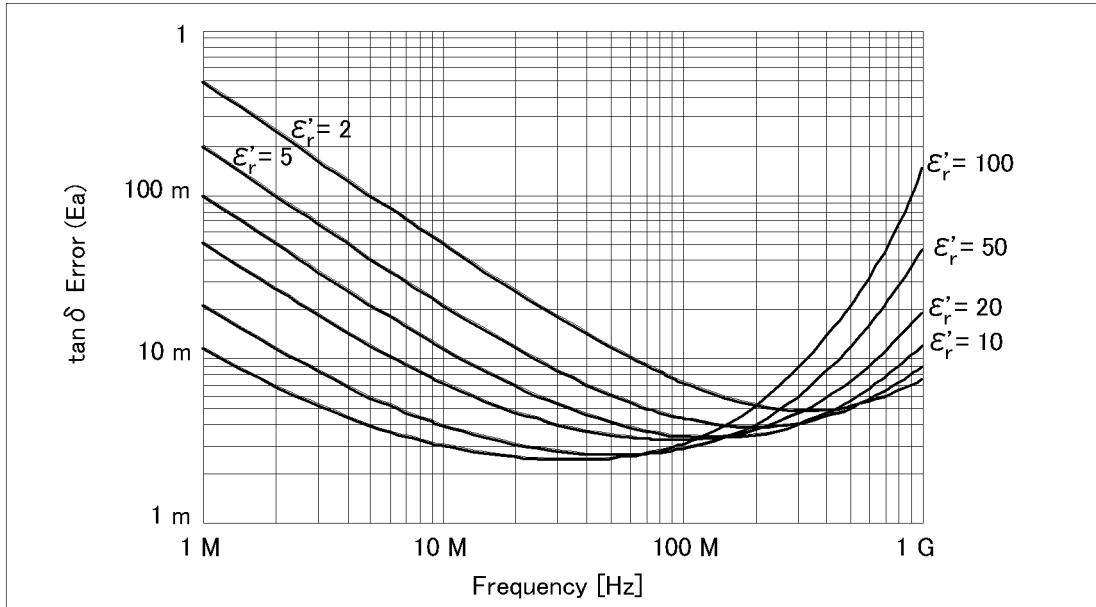
**Figure 11-16** Dielectric Loss Tangent ( $\tan\delta$ ) Accuracy vs. Frequency (at  $t = 0.3$  mm, typical)



E4991a0e0814

**NOTE** This graph shows only frequency dependence of  $E_a$  for simplification. The typical accuracy of  $\tan\delta$  is defined as  $E_a + E_b$ ; refer to “Typical accuracy of permittivity parameters” on page 264.

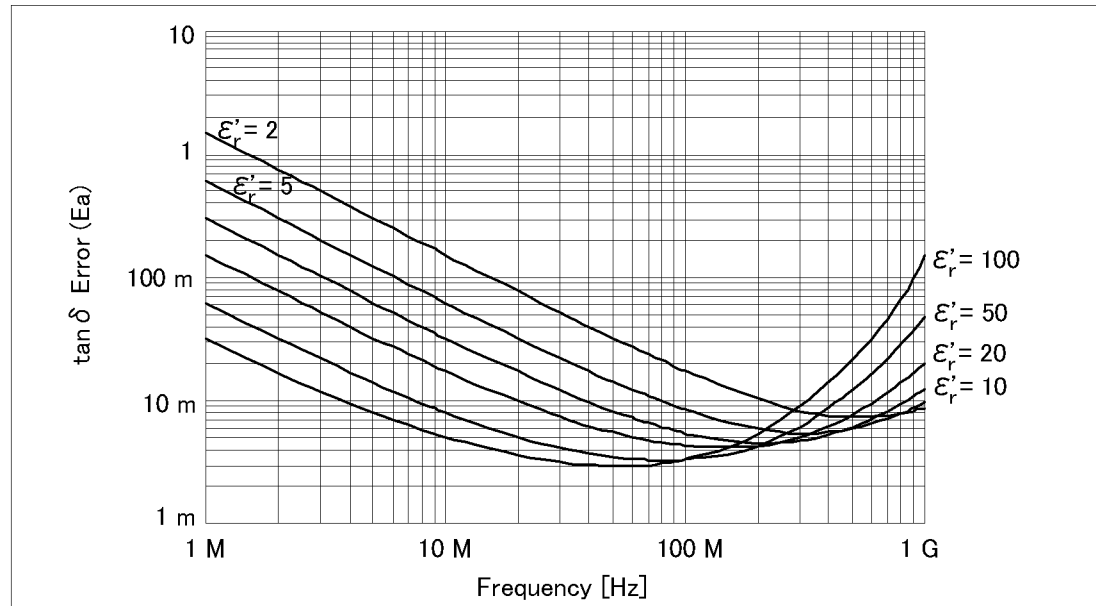
Figure 11-17 Dielectric Loss Tangent ( $\tan\delta$ ) Accuracy vs. Frequency (at  $t = 1$  mm, typical)



E4991a0e0815

**NOTE** This graph shows only frequency dependence of  $E_a$  for simplification. The typical accuracy of  $\tan\delta$  is defined as  $E_a + E_b$ ; refer to “Typical accuracy of permittivity parameters” on page 264.

Figure 11-18 Dielectric Loss Tangent ( $\tan\delta$ ) Accuracy vs. Frequency (at  $t = 3$  mm, typical)

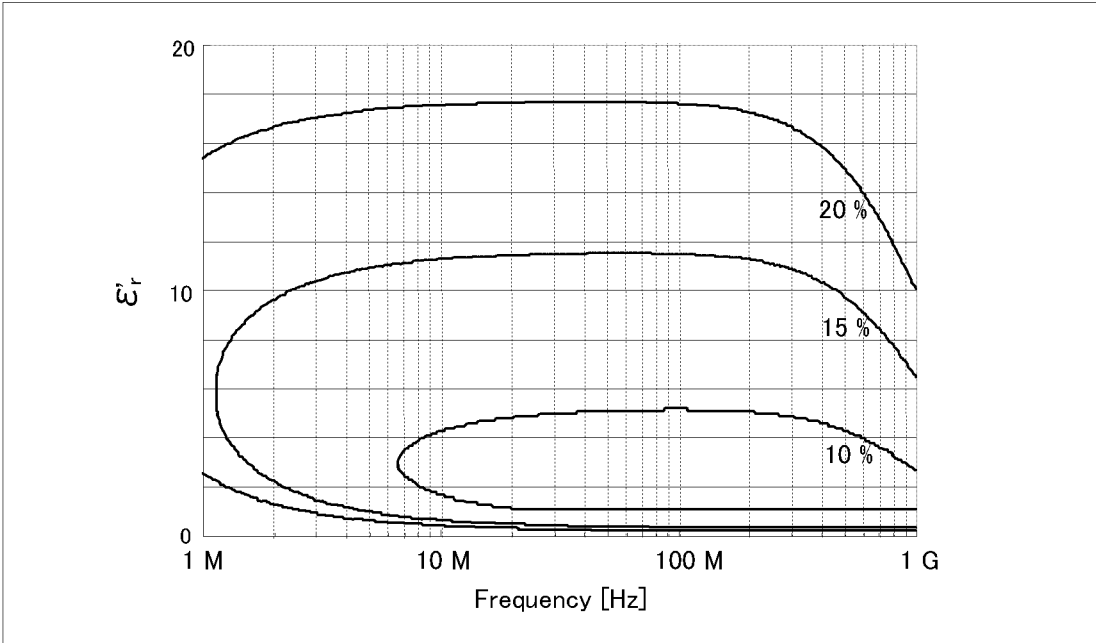


E4991a0e0816

**NOTE** This graph shows only frequency dependence of  $E_a$  for simplification. The typical accuracy of  $\tan\delta$  is defined as  $E_a + E_b$ ; refer to “Typical accuracy of permittivity

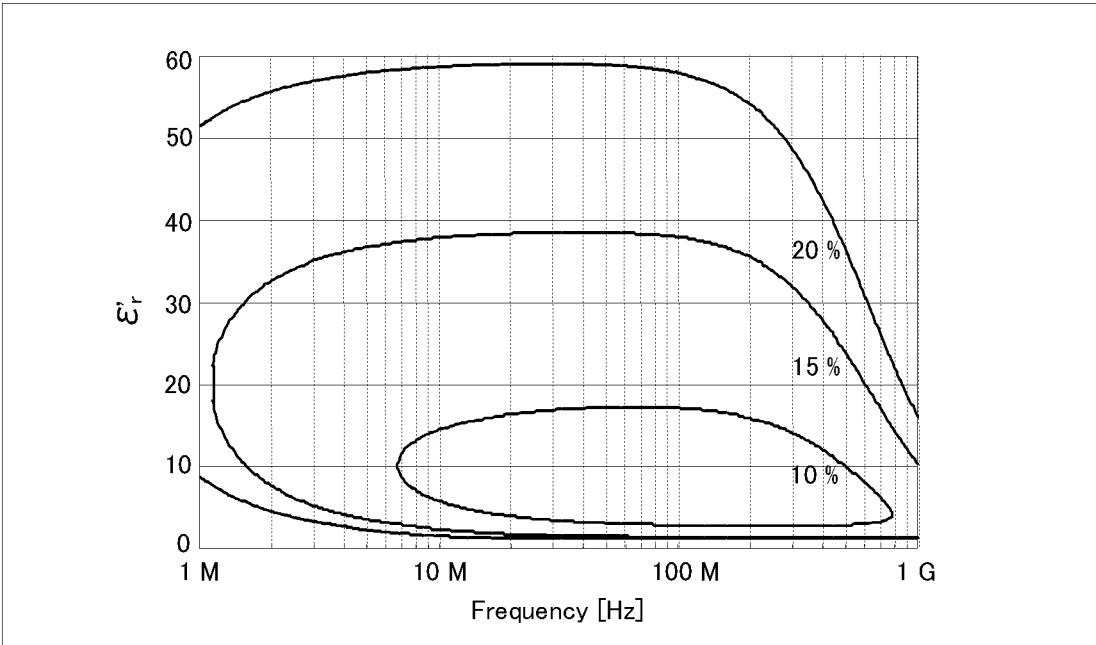
parameters” on page 264.

**Figure 11-19** Permittivity ( $\epsilon'_r$ ) vs. Frequency (at  $t = 0.3$  mm, typical)



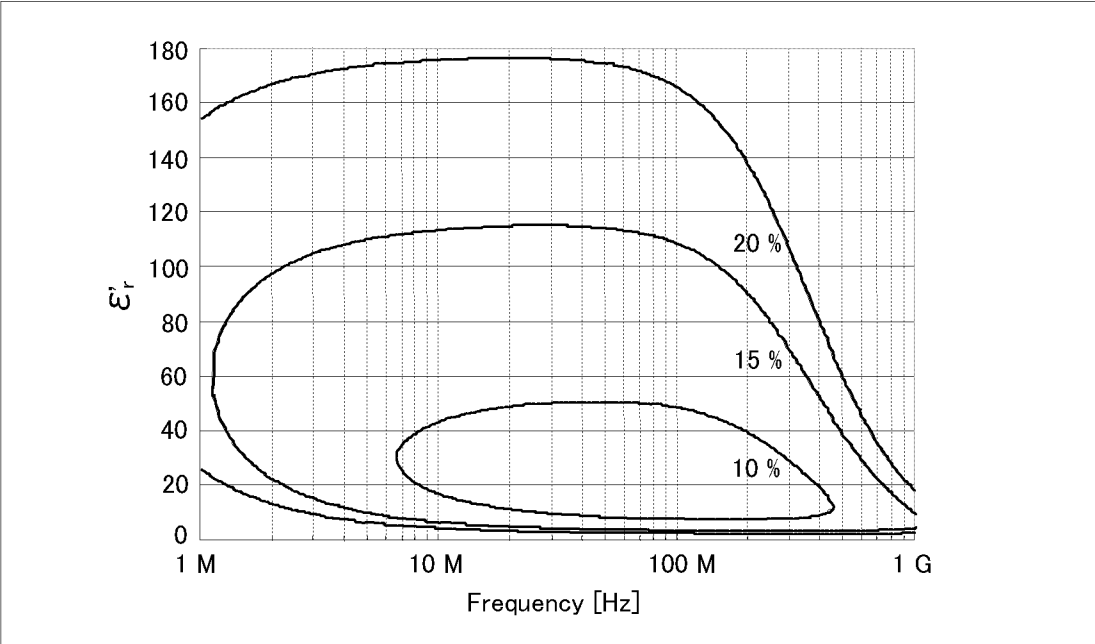
E4991a0e0817

**Figure 11-20** Permittivity ( $\epsilon'_r$ ) vs. Frequency (at  $t = 1$  mm, typical)



E4991a0e0818

Figure 11-21 Permittivity ( $\epsilon'_r$ ) vs. Frequency (at  $t = 3$  mm, typical)

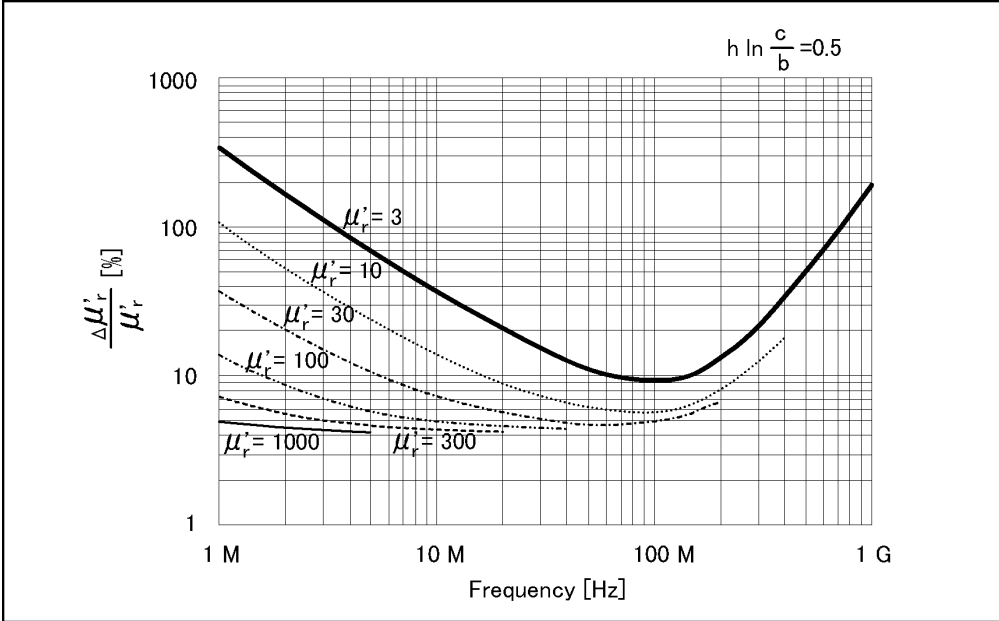


E4991aoe0819

**Examples of Calculated Permeability Measurement Accuracy**

**Figure 11-22**

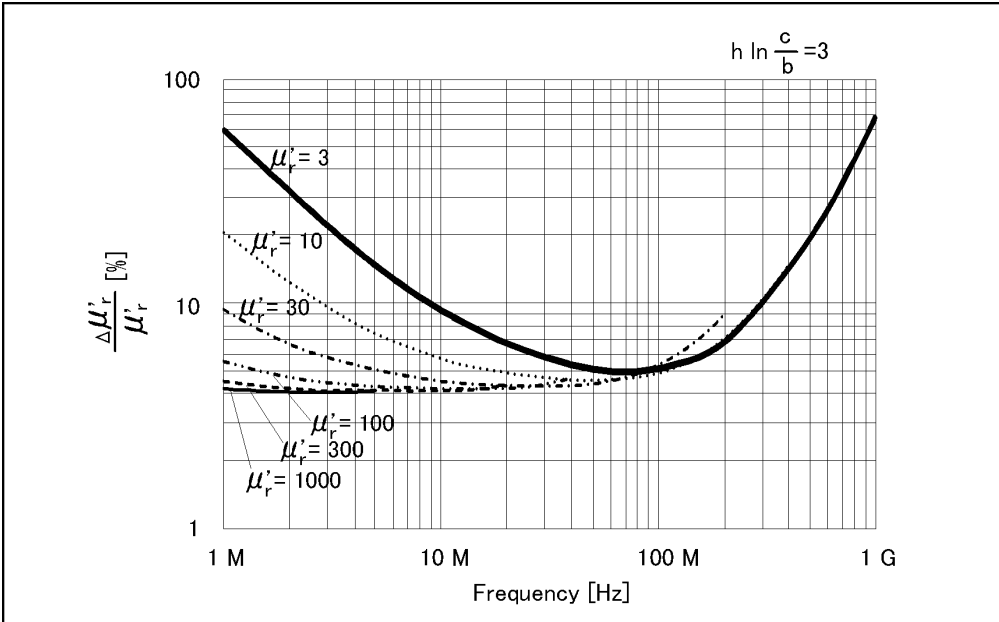
**Permeability Accuracy ( $\frac{\Delta\mu'_r}{\mu'_r}$ ) vs. Frequency (at  $F = 0.5$ , typical)**



E4991a0e0848

**Figure 11-23**

**Permeability Accuracy ( $\frac{\Delta\mu'_r}{\mu'_r}$ ) vs. Frequency (at  $F = 3$ , typical)**



E4991a0e0849

Figure 11-24 Permeability Accuracy ( $\frac{\Delta\mu'_r}{\mu'_r}$ ) vs. Frequency (at  $F = 10$ , typical)

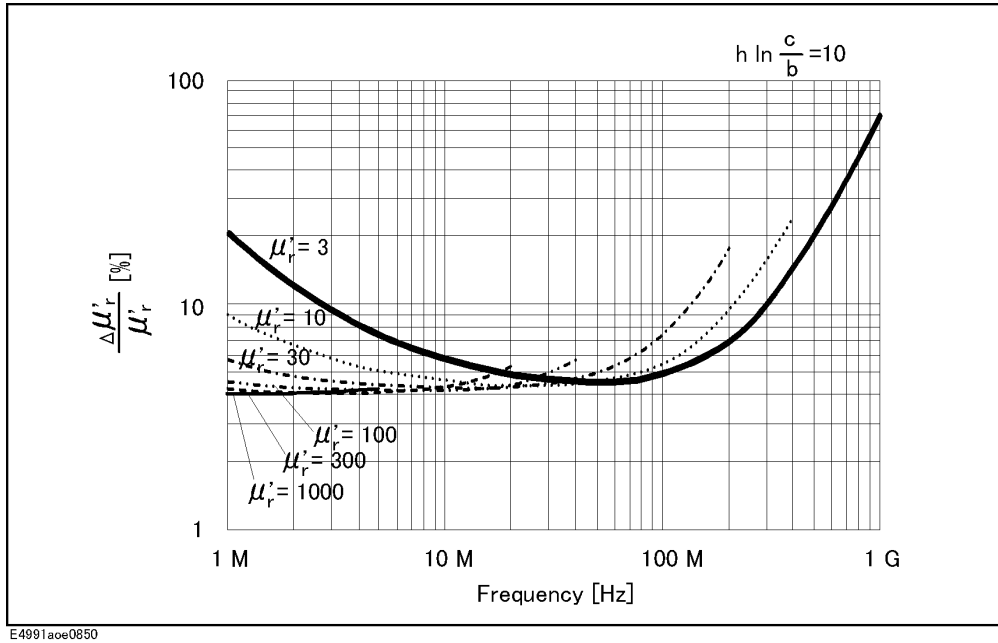
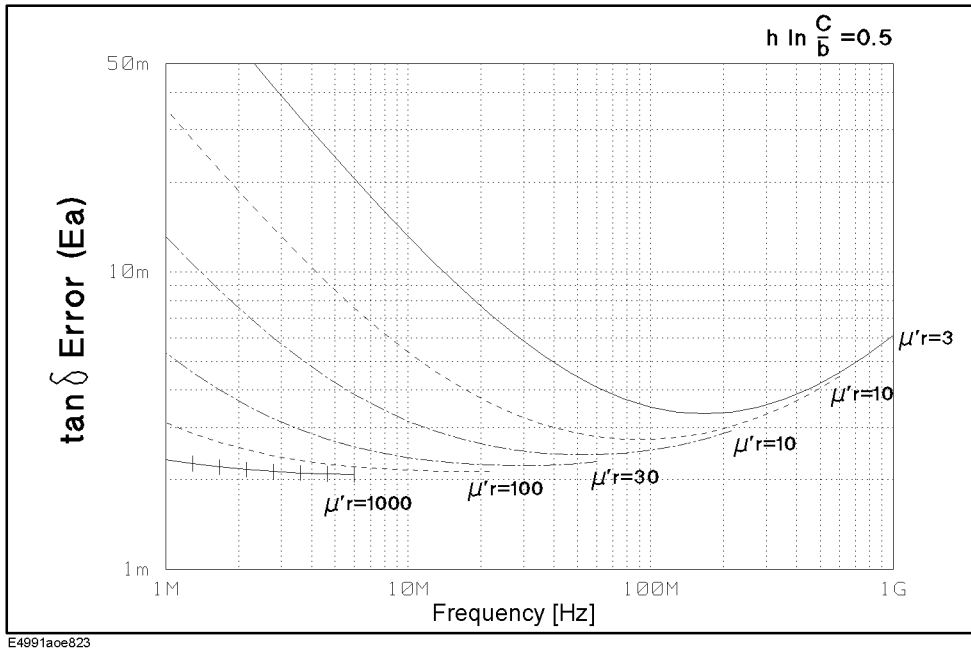


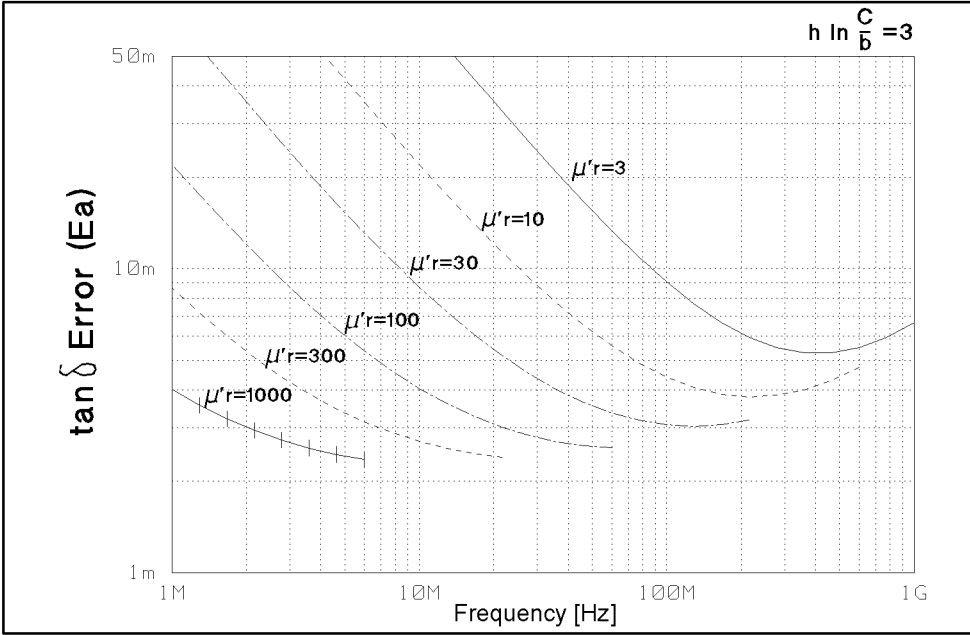
Figure 11-25 Permeability Loss Tangent ( $\tan\delta$ ) Accuracy vs. Frequency (at  $F = 0.5$ , typical)



**NOTE**

This graph shows only frequency dependence of  $E_a$  for simplification. The typical accuracy of  $\tan\delta$  is defined as  $E_a + E_b$ ; refer to “Typical accuracy of permeability parameters” on page 265.

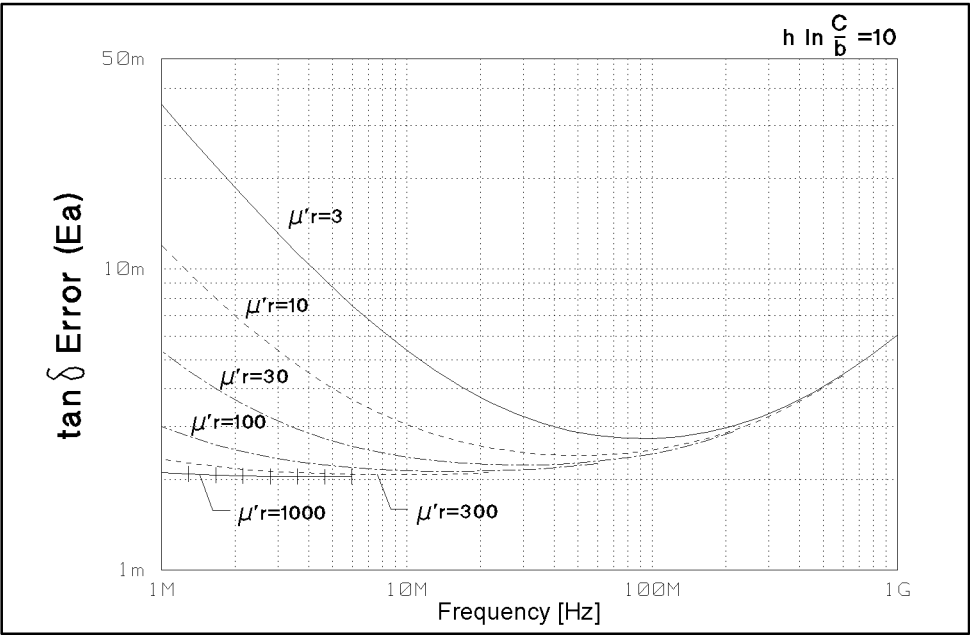
Figure 11-26 Permeability Loss Tangent ( $\tan\delta$ ) Accuracy vs. Frequency (at  $F = 3$ , typical)



E4991a0e824

**NOTE** This graph shows only frequency dependence of  $E_a$  for simplification. The typical accuracy of  $\tan\delta$  is defined as  $E_a + E_b$ ; refer to “Typical accuracy of permeability parameters” on page 265.

Figure 11-27 Permeability Loss Tangent ( $\tan\delta$ ) Accuracy vs. Frequency (at  $F = 10$ , typical)

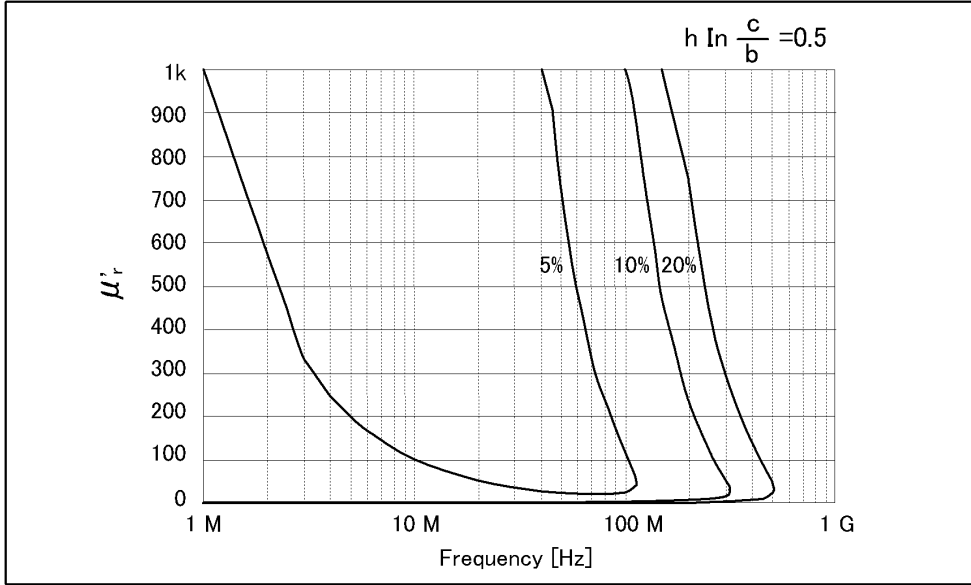


E4991a0e825

**NOTE**

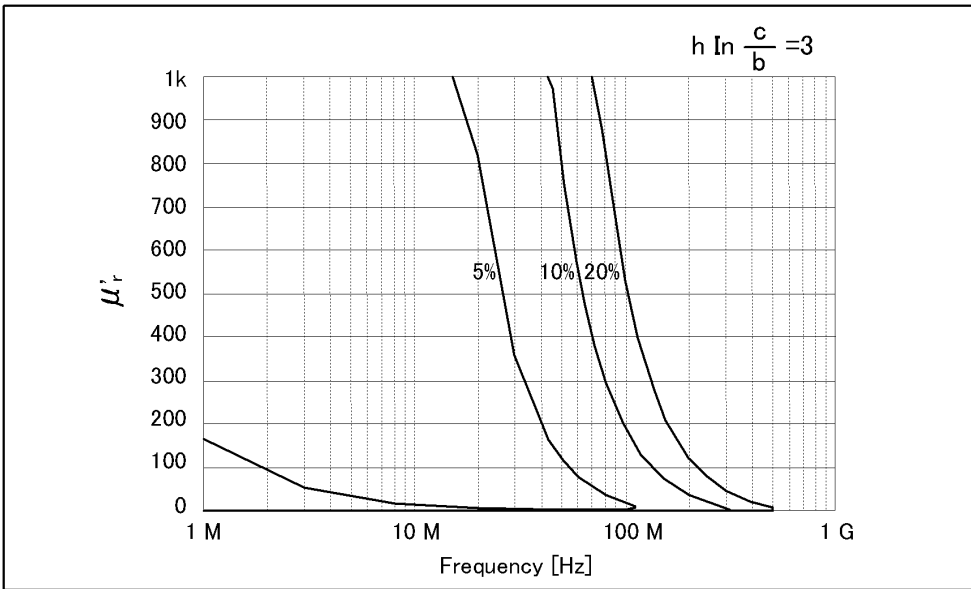
This graph shows only frequency dependence of  $E_a$  for simplification. The typical accuracy of  $\tan\delta$  is defined as  $E_a + E_b$ ; refer to “Typical accuracy of permeability parameters” on page 265.

**Figure 11-28 Permeability ( $\mu'_r$ ) vs. Frequency (at  $F = 0.5$ , typical)**



e4991ace0858

**Figure 11-29 Permeability ( $\mu'_r$ ) vs. Frequency (at  $F = 3$ , typical)**

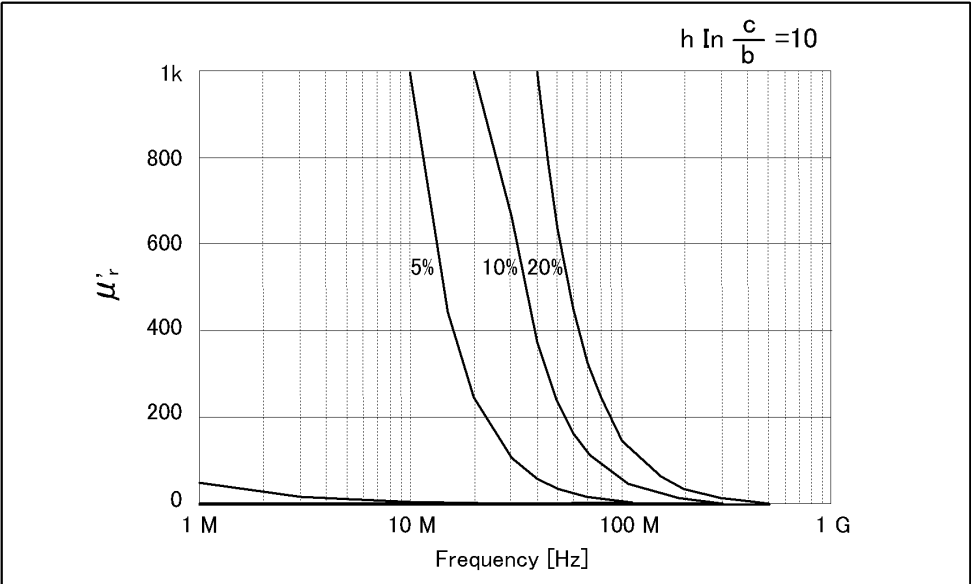


e4991ace0860



Figure 11-30

Permeability ( $\mu'_r$ ) vs. Frequency (at  $F = 10$ , typical)



e4991ace0859

---

## Option 007 Temperature Characteristic Test Kit

This section contains specifications and supplemental information for the E4991A Option 007. Except for the contents in this section, the E4991A standard specifications and supplemental information are applied.

### Operation Temperature

---

Range	-55°C to +150°C (at the test port of the heat-resistant cable)
-------	--

### Source Characteristics

#### Frequency

---

Range	1 MHz to 3 GHz
-------	----------------

#### Oscillator Level

---

Source power accuracy at the test port of the heat-resistant cable:

Frequency $\leq$ 1 GHz	+2 dB/-4 dB (23°C $\pm$ 5°C) +4 dB/-6 dB (5°C to 40°C)
Frequency $>$ 1 GHz	+3 dB/-6 dB (23°C $\pm$ 5°C) +5 dB/-8 dB (5°C to 40°C)

### Measurement Accuracy (at 23°C $\pm$ 5°C)

#### Conditions

The measurement accuracy is specified when the following conditions are met:

---

Calibration	Open, Short and Load calibration is completed at the test port (7-mm connector) of the heat-resistant cable
Calibration temperature	Calibration is performed at an environmental temperature within the range of 23°C $\pm$ 5°C. Measurement error doubles when calibration temperature is below 18°C or above 28°C.
Measurement temperature range	Within $\pm$ 5°C of calibration temperature
Measurement plane	Same as calibration plane
Oscillator level	Same as the level set at calibration

---

#### NOTE

The heat-resistant cable must be kept at the same position throughout calibration and measurement.

---

### Impedance, Admittance and Phase Angle Accuracy

$ Z ,  Y $	$\pm(E_a + E_b)$ [%] (see Figure 11-31 through Figure 11-34 for calculated accuracy)
$\theta$	$\pm \frac{(E_a + E_b)}{100}$ [rad]

Where,

$E_a =$

At Oscillator level $\geq -33$ dBm	$\pm 0.8$ [%] ( $1 \text{ MHz} \leq f \leq 100 \text{ MHz}$ ) $\pm 1$ [%] ( $100 \text{ MHz} < f \leq 500 \text{ MHz}$ ) $\pm 1.2$ [%] ( $500 \text{ MHz} < f \leq 1 \text{ GHz}$ ) $\pm 2.5$ [%] ( $1 \text{ GHz} < f \leq 1.8 \text{ GHz}$ ) $\pm 5$ [%] ( $1.8 \text{ GHz} < f \leq 3 \text{ GHz}$ )
------------------------------------	---

At Oscillator level $< -33$ dBm	$\pm 1.2$ [%] ( $1 \text{ MHz} \leq f \leq 100 \text{ MHz}$ ) $\pm 1.5$ [%] ( $100 \text{ MHz} < f \leq 500 \text{ MHz}$ ) $\pm 1.5$ [%] ( $500 \text{ MHz} < f \leq 1 \text{ GHz}$ ) $\pm 2.5$ [%] ( $1 \text{ GHz} < f \leq 1.8 \text{ GHz}$ ) $\pm 5$ [%] ( $1.8 \text{ GHz} < f \leq 3 \text{ GHz}$ )
---------------------------------	---

(Where, f is frequency)

$E_b =$

$$\pm \left( \frac{Z_s}{|Z_x|} + Y_o \times |Z_x| \right) \times 100 \text{ [%]}$$

Where,

$|Z_x| =$  Absolute value of measured impedance

$Z_s =$

At Oscillator level = $-3$ dBm, $-13$ dBm, or $-23$ dBm	$\pm (30 + 0.5 \times F)$ [ $\text{m}\Omega$ ] (Point averaging factor $\geq 8$ ) $\pm (40 + 0.5 \times F)$ [ $\text{m}\Omega$ ] (Point averaging factor $\leq 7$ )
---	--

At Oscillator level $\geq -33$ dBm	$\pm (35 + 0.5 \times F)$ [ $\text{m}\Omega$ ] (Point averaging factor $\geq 8$ ) $\pm (70 + 0.5 \times F)$ [ $\text{m}\Omega$ ] (Point averaging factor $\leq 7$ )
------------------------------------	--

At Oscillator level $< -33$ dBm	$\pm (50 + 0.5 \times F)$ [ $\text{m}\Omega$ ] (Point averaging factor $\geq 8$ ) $\pm (150 + 0.5 \times F)$ [ $\text{m}\Omega$ ] (Point averaging factor $\leq 7$ )
---------------------------------	---

(Where, F is frequency in MHz)

$Y_o =$

At Oscillator level = $-3$ dBm, $-13$ dBm, $-23$ dBm	$\pm (12 + 0.1 \times F)$ [ $\mu\text{S}$ ] (Point averaging factor $\geq 8$ ) $\pm (20 + 0.1 \times F)$ [ $\mu\text{S}$ ] (Point averaging factor $\leq 7$ )
--	--

At Oscillator level $\geq -33$ dBm	$\pm (15 + 0.1 \times F)$ [ $\mu\text{S}$ ] (Point averaging factor $\geq 8$ ) $\pm (40 + 0.1 \times F)$ [ $\mu\text{S}$ ] (Point averaging factor $\leq 7$ )
------------------------------------	--

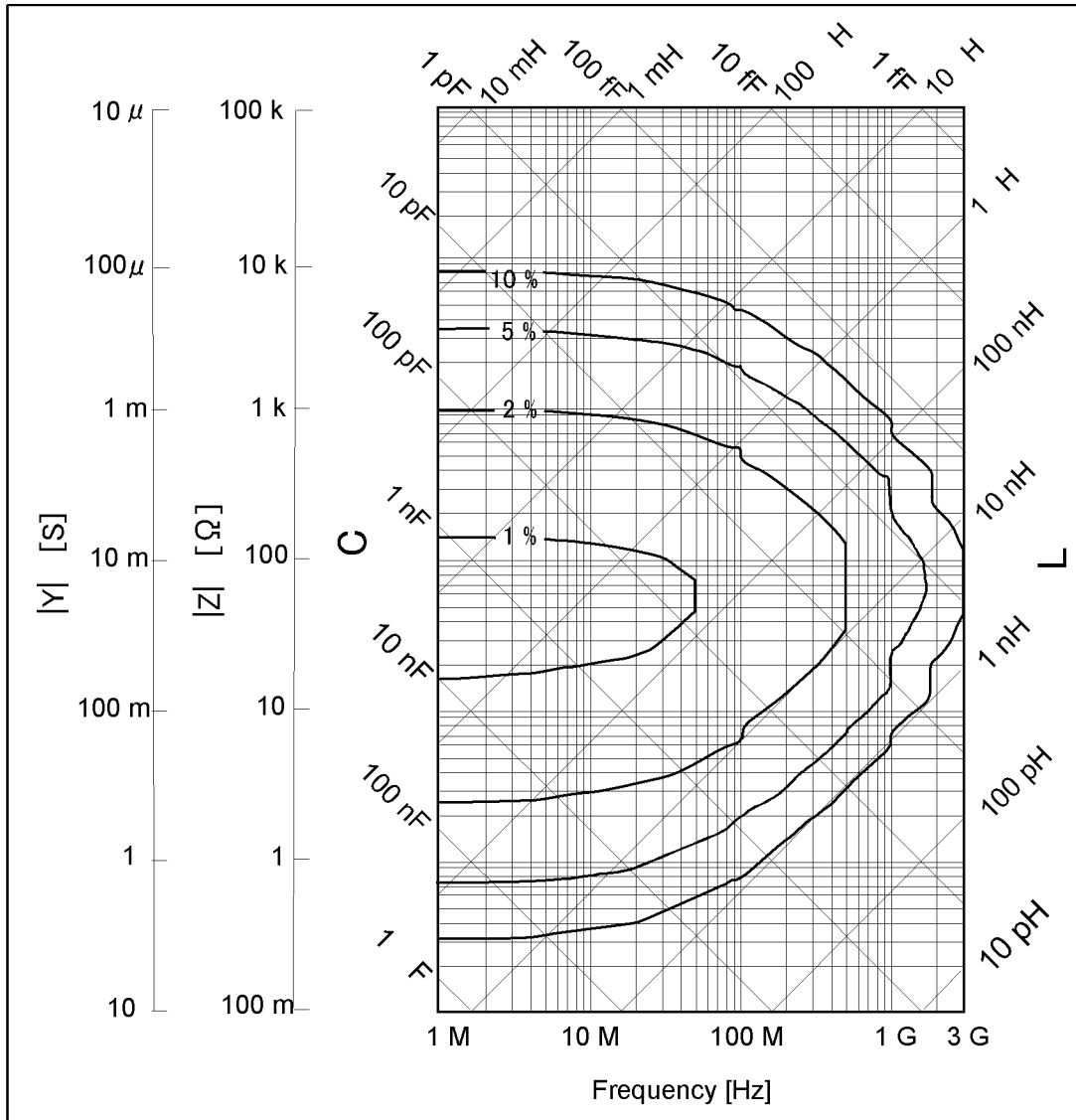
At Oscillator level $< -33$ dBm	$\pm (35 + 0.1 \times F)$ [ $\mu\text{S}$ ] (Point averaging factor $\geq 8$ ) $\pm (80 + 0.1 \times F)$ [ $\mu\text{S}$ ] (Point averaging factor $\leq 7$ )
---------------------------------	--

(Where, F is frequency in MHz)

Calculated Impedance/Admittance Measurement Accuracy

Figure 11-31

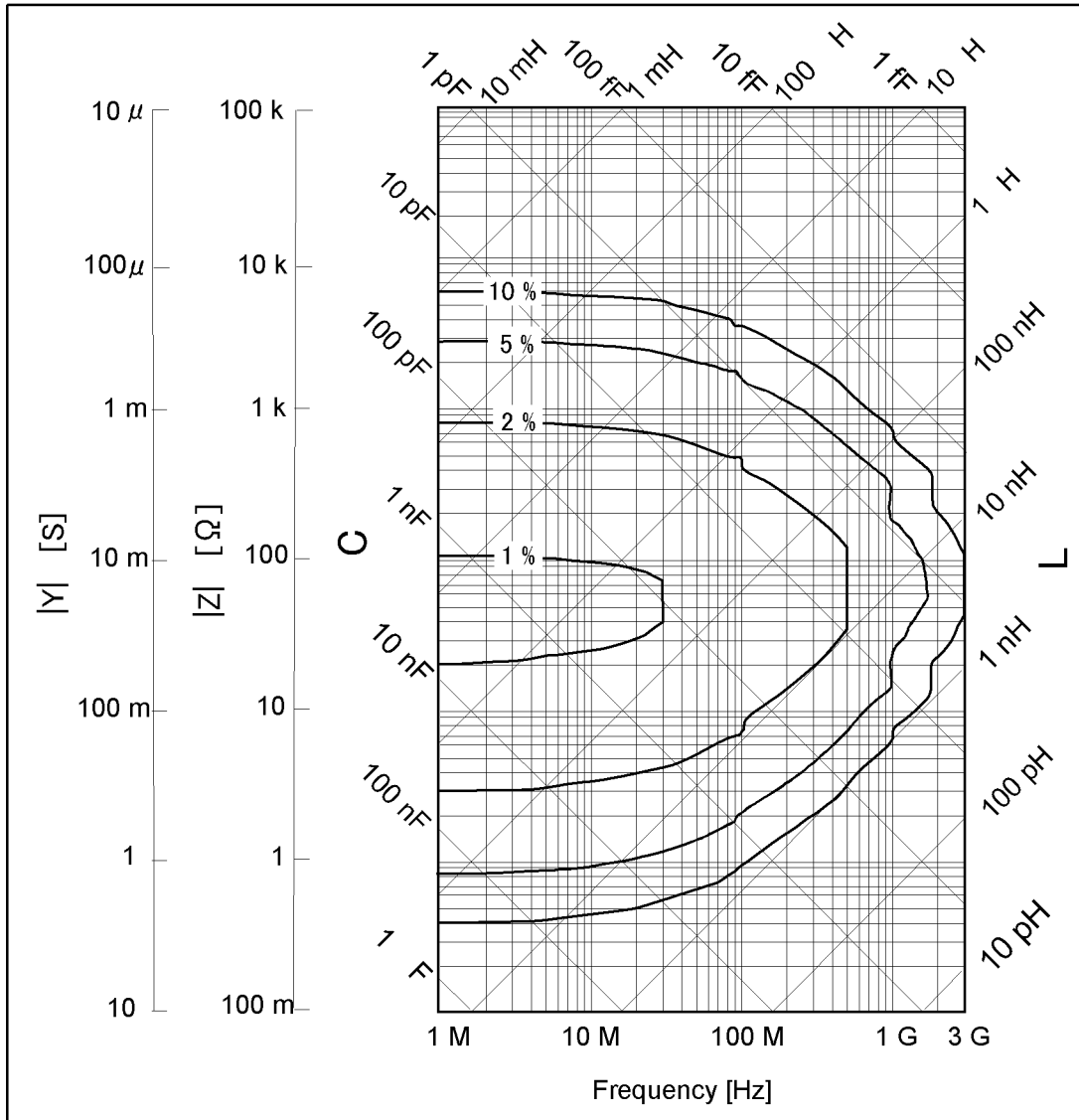
$|Z|, |Y|$  Measurement Accuracy  
 Calibration: Open/Short/Load  
 Oscillator level = -23 dBm, -13 dBm, -3 dBm  
 Point averaging factor  $\geq 8$   
 Within  $\pm 5^\circ\text{C}$  of calibration temperature



e4991ace831

Figure 11-32

**$|Z|$ ,  $|Y|$  Measurement Accuracy**  
**Calibration: Open/Short/Load**  
**Oscillator level  $\geq -33$  dBm**  
**Point averaging factor  $\geq 8$**   
**Within  $\pm 5^\circ\text{C}$  of calibration temperature**



e4991a0e833

Figure 11-33

**$|Z|, |Y|$  Measurement Accuracy**  
**Calibration: Open/Short/Load**  
**Oscillator level  $\geq -33$  dBm**  
**Point averaging factor  $\leq 7$**   
**Within  $\pm 5^\circ\text{C}$  of calibration temperature**

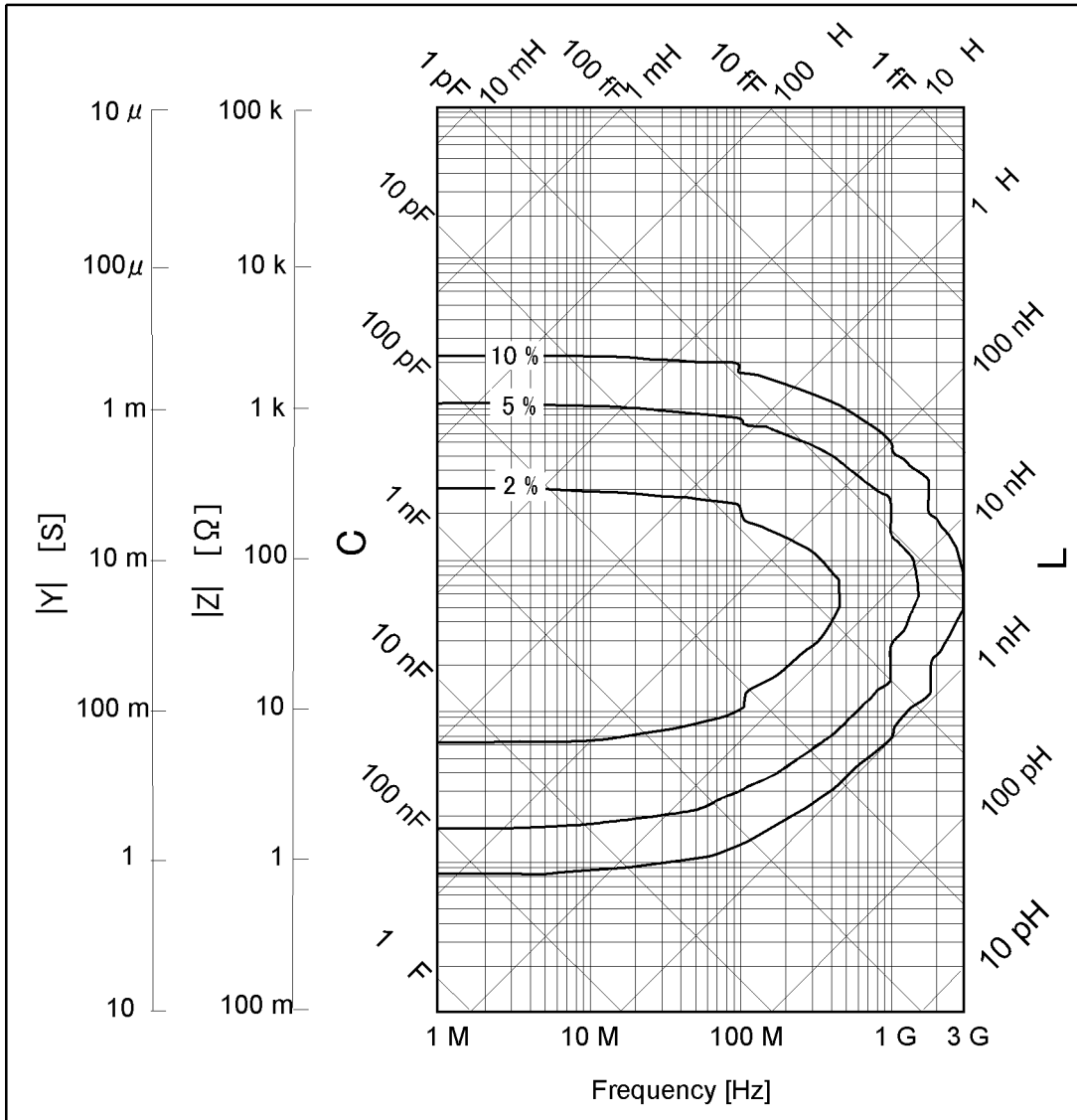
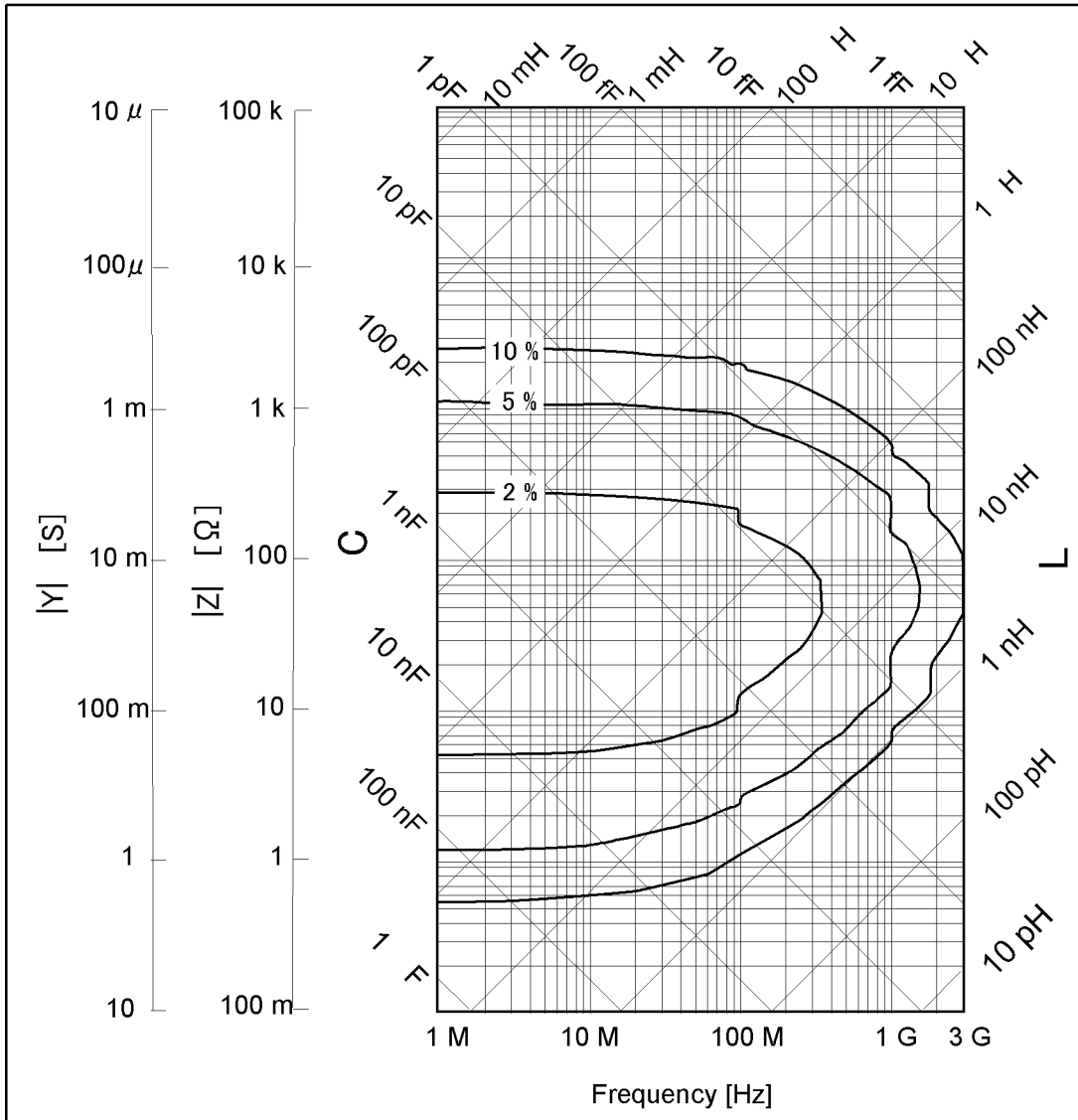


Figure 11-34

**|Z|, |Y| Measurement Accuracy**  
**Calibration: Open/Short/Load**  
**Oscillator level < -33 dBm**  
**Point averaging factor ≥ 8**  
**Within ± 5°C of calibration temperature**



e4991a0e834

## Typical Effects of Temperature Change on Measurement Accuracy

When the temperature at the test port (7-mm connector) of the heat-resistant cable changes from the calibration temperature, typical measurement accuracy involving temperature dependence effects (errors) is applied. The typical measurement accuracy is represented by the sum of error due to temperature coefficients ( $E_a'$ ,  $Z_s'$  and  $Y_o'$ ), hysteresis error ( $E_{ah}$ ,  $Z_{sh}$  and  $Y_{oh}$ ) and the specified accuracy.

### Conditions

The typical measurement accuracy is applied when the following conditions are met:

---

Conditions of  $E_a'$ ,  $Z_s'$  and  $Y_o'$ :

Measurement temperature	-55°C to 5°C or 40°C to 150 °C at test port. For 5°C to 40°C, $E_a'$ , $Y_o'$ and $Z_s'$ are 0 (neglected).
Temperature change	$\geq 5^\circ\text{C}$ from calibration temperature when the temperature compensation is off. $\geq 20^\circ\text{C}$ from calibration temperature when the temperature compensation is set to on.
Calibration temperature	$23^\circ\text{C} \pm 5^\circ\text{C}$
Calibration mode	User Calibration
Temperature compensation	Temperature compensation data is acquired at the same temperature points as measurement temperatures.

Conditions of  $E_{ah}$ ,  $Z_{sh}$  and  $Y_{oh}$ :

Measurement temperature	-55°C to 150 °C at the test port
Calibration temperature	$23^\circ\text{C} \pm 5^\circ\text{C}$
Calibration mode	User Calibration



### Typical measurement accuracy (involving temperature dependence effects)

$$|Z|, |Y| \quad \pm(E_a + E_b + E_c + E_d) \text{ [%]}$$

$$\theta \quad \pm \frac{(E_a + E_b + E_c + E_d)}{100} \text{ [rad]}$$

Where,

$$E_c = E_a' \times \Delta T + E_{ah}$$

$$E_d = \pm \left( \frac{Z_s' \times \Delta T + Z_{sh}}{|Z_x|} + (Y_o' \times \Delta T + Y_{oh}) \times |Z_x| \right) \times 100 \text{ [%]}$$

Where,

$$|Z_x| = \text{Absolute value of measured impedance}$$

Here,  $E_a'$ ,  $Z_s'$  and  $Y_o'$  are given by the following equations:

	Without temperature compensation	With temperature compensation	
		1 MHz ≤ f < 500 MHz	500 MHz ≤ f ≤ 3 GHz
$E_a'$	0.006 + 0.015 × f [%/°C]	0.006 + 0.015 × f [%/°C]	0.006 + 0.015 × f [%/°C]
$Z_s'$	1 + 10 × f [mΩ/°C]	1 + 10 × f [mΩ/°C]	5 + 2 × f [mΩ/°C]
$Y_o'$	0.3 + 3 × f [μS/°C]	0.3 + 3 × f [μS/°C]	1.5 + 0.6 × f [μS/°C]

f = Measurement frequency in GHz

#### NOTE

See graphs in Figure 11-35 for the calculated values of  $(E_c + E_d)$  exclusive of the hysteresis errors  $E_{ah}$ ,  $Z_{sh}$  and  $Y_{oh}$ , when measured impedance is 10 Ω and 250 Ω.

$E_{ah}$ ,  $Z_{sh}$  and  $Y_{oh}$  are given by following equations:

$$E_{ah} = E_a' \times \Delta T_{max} \times 0.3 \text{ [%]}$$

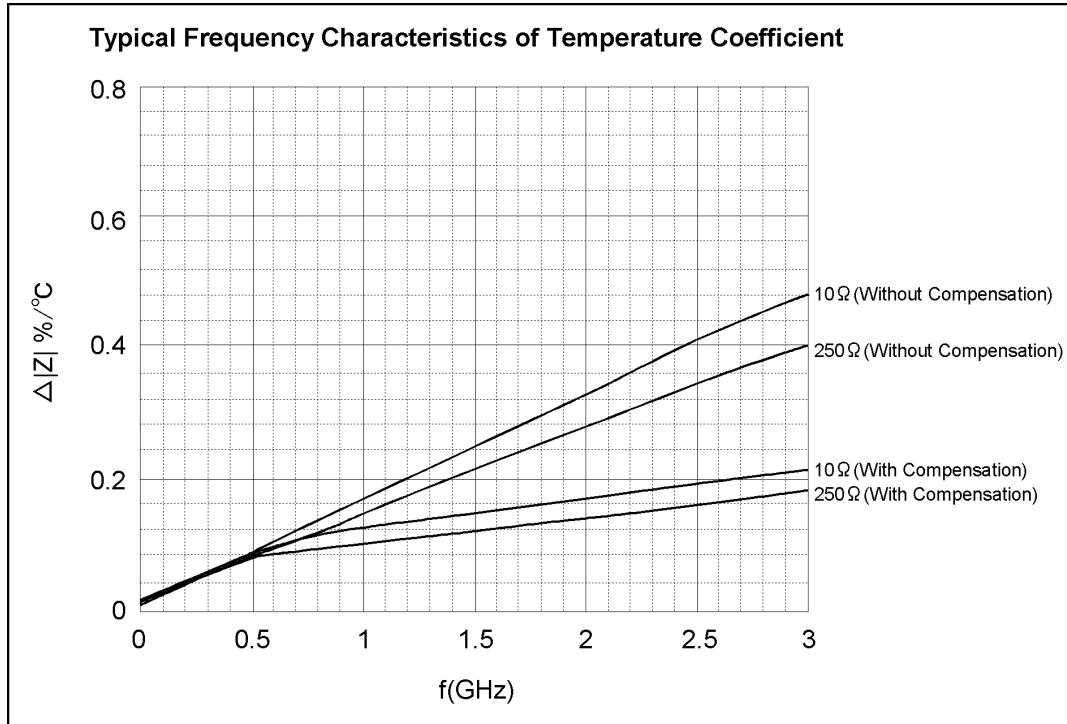
$$Z_{sh} = Z_s' \times \Delta T_{max} \times 0.3 \text{ [mΩ]}$$

$$Y_{oh} = Y_o' \times \Delta T_{max} \times 0.3 \text{ [μS]}$$

$\Delta T$  = Difference of measurement temperature from calibration temperature

$\Delta T_{max}$  = Maximum temperature change (°C) at the test port from calibration temperature after the calibration is performed.

Figure 11-35 Typical frequency characteristics of temperature coefficient,  $(E_c + E_d)/\Delta T$ , when  $|Z_x|=10\ \Omega$  and  $250\ \Omega$ ,  $E_{ah} = Z_{sh} = Y_{oh} = 0$  are assumed.



e4991a0e835

**NOTE**

Read the value of  $\Delta|Z| \text{ %/}^\circ\text{C}$  at the material measurement frequency and multiply it by  $\Delta T$  to derive the value of  $(E_c + E_d)$  when  $E_{ah} = Z_{sh} = Y_{oh} = 0$ .

## Typical Material Measurement Accuracy When Using Option 002 and 007

Material measurement accuracy contains the permittivity and permeability measurement accuracy when the E4991A with Option 002 Material Measurement and 007 Temperature Measurement Test Kit is used with the 16453A or 16454A test fixture.

### Measurement Parameter

Permittivity parameters	$ \epsilon_r , \epsilon'_r, \epsilon''_r, \tan \delta$
Permeability parameters	$ \mu_r , \mu'_r, \mu''_r, \tan \delta$

### Frequency

Use with Agilent 16453A	1 MHz to 1 GHz (typical)
Use with Agilent 16454A	1 MHz to 1 GHz (typical)

### Operation Temperature

Range	-55°C to +150°C (at the test port of the heat-resistant cable)
-------	--

## Typical Material Measurement Accuracy (at 23°C ± 5°C)

### Conditions

The measurement accuracy is specified when the following conditions are met:

Calibration	Open, Short and Load calibration is completed at the test port (7-mm connector) of the heat-resistant cable
Calibration temperature	Calibration is performed at an environmental temperature within the range of 23°C ± 5°C. Measurement error doubles when calibration temperature is below 18°C or above 28°C.
Measurement temperature range	Within ± 5°C of calibration temperature
Measurement frequency points	Same as calibration points (User Cal)
Oscillator level	Same as the level set at calibration
Point averaging factor	≥ 8

**Typical permittivity measurement accuracy**

---

$$\begin{aligned} \epsilon'_{rm} \text{ accuracy} \\ \left( E_{\epsilon} = \frac{\Delta\epsilon'_{rm}}{\epsilon'_{rm}} \right) \end{aligned} \quad \pm \left[ 5 + \left( 10 + \frac{0.5}{f} \right) \times \frac{t}{\epsilon'_{rm}} + 0.25 \times \frac{\epsilon'_{rm}}{t} + \frac{100}{\left| 1 - \left( \frac{13}{f\sqrt{\epsilon'_{rm}}} \right)^2 \right|} \right]$$

[%] (at  $\tan \delta < 0.1$ )

Loss tangent accuracy of  $\epsilon''_{rm}$   
 (=  $\Delta \tan \delta$ )  $\pm(E_a + E_b)$  (at  $\tan \delta < 0.1$ )

where,

$$E_a =$$

$$\text{at Frequency } \leq 1 \text{ GHz} \quad 0.002 + \frac{0.0025}{f} \times \frac{t}{\epsilon'_{rm}} + (0.008 \times f) + \frac{0.1}{\left| 1 - \left( \frac{13}{f\sqrt{\epsilon'_{rm}}} \right)^2 \right|}$$

$$E_b = \left( \frac{\Delta\epsilon'_{rm}}{\epsilon'_{rm}} \times \frac{1}{100} + \epsilon'_{rm} \times \frac{0.002}{t} \right) \times \tan \delta$$

$f$  = Measurement frequency [GHz]

$t$  = Thickness of MUT (material under test) [mm]

$\epsilon'_{rm}$  = Measured value of  $\epsilon'_{rm}$

$\tan \delta$  = Measured value of dielectric loss tangent

---

**NOTE** The accuracy applies when the electrode pressure of the 16453A is set to Maximum.

### Typical permeability measurement accuracy

---

$$\mu'_{r} \text{ accuracy} \quad 4 + \frac{0.02}{f} \times \frac{25}{F \times \mu'_{rm}} + F \times \mu'_{rm} \times \left(1 + \frac{15}{F \times \mu'_{rm}}\right)^2 \times f^2$$

$$\left(E_{\mu} = \frac{\Delta\mu'_{rm}}{\mu'_{rm}}\right) \quad [\%] \text{ (at } \tan \delta < 0.1 \text{)}$$

Loss tangent accuracy of  $\mu_r$   
 (=  $\Delta \tan \delta$ )  $\pm(E_a + E_b)$  (at  $\tan \delta < 0.1$ )

where,

$$E_a = 0.002 + \frac{0.005}{F \times \mu'_{rm} \times f} + 0.004 \times f$$

$$E_b = \frac{\Delta\mu'_{rm}}{\mu'_{rm}} \times \frac{\tan \delta}{100}$$

$f$  = Measurement frequency [GHz]

$F$  =  $h \ln \frac{c}{b}$  [mm]

$h$  = Height of MUT (material under test) [mm]

$b$  = Inner diameter of MUT [mm]

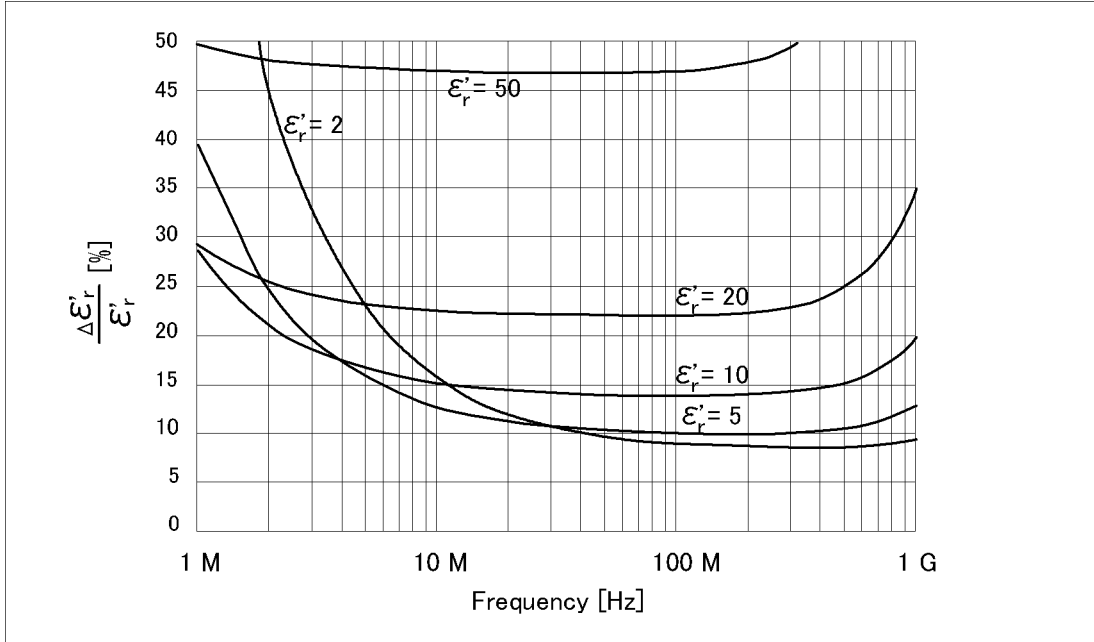
$c$  = Outer diameter of MUT [mm]

$\mu'_{rm}$  = Measured value of  $\mu'_r$

$\tan \delta$  = Measured value of loss tangent

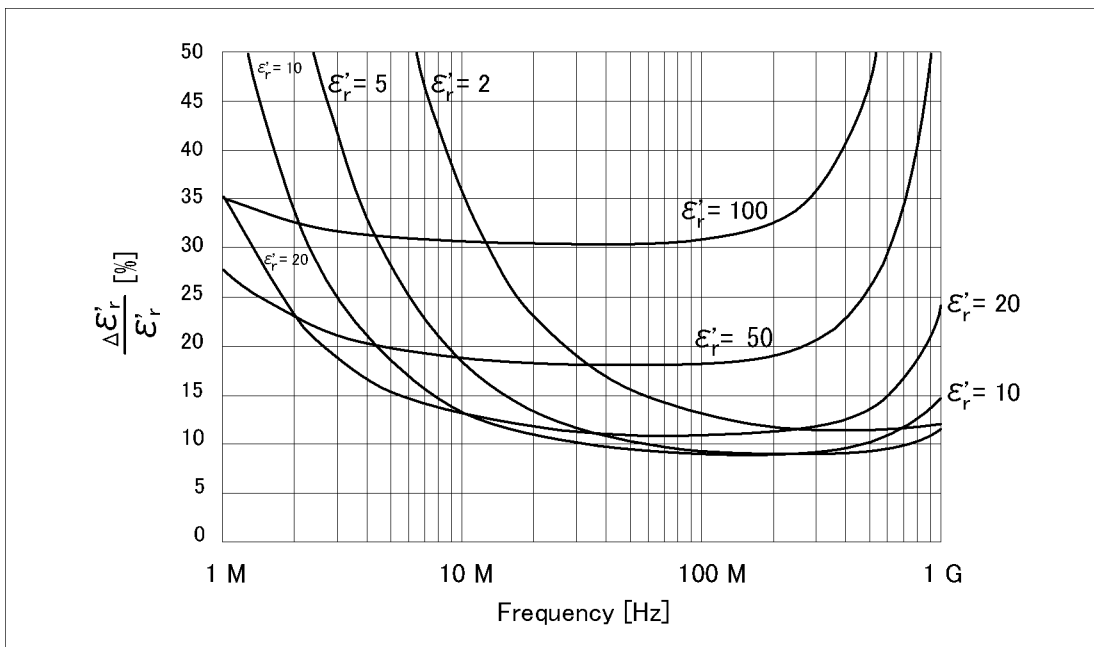
**Examples of Calculated Permittivity Measurement Accuracy**

**Figure 11-36** Permittivity Accuracy ( $\frac{\Delta\epsilon'_r}{\epsilon'_r}$ ) vs. Frequency (at  $t = 0.3$  mm, typical)



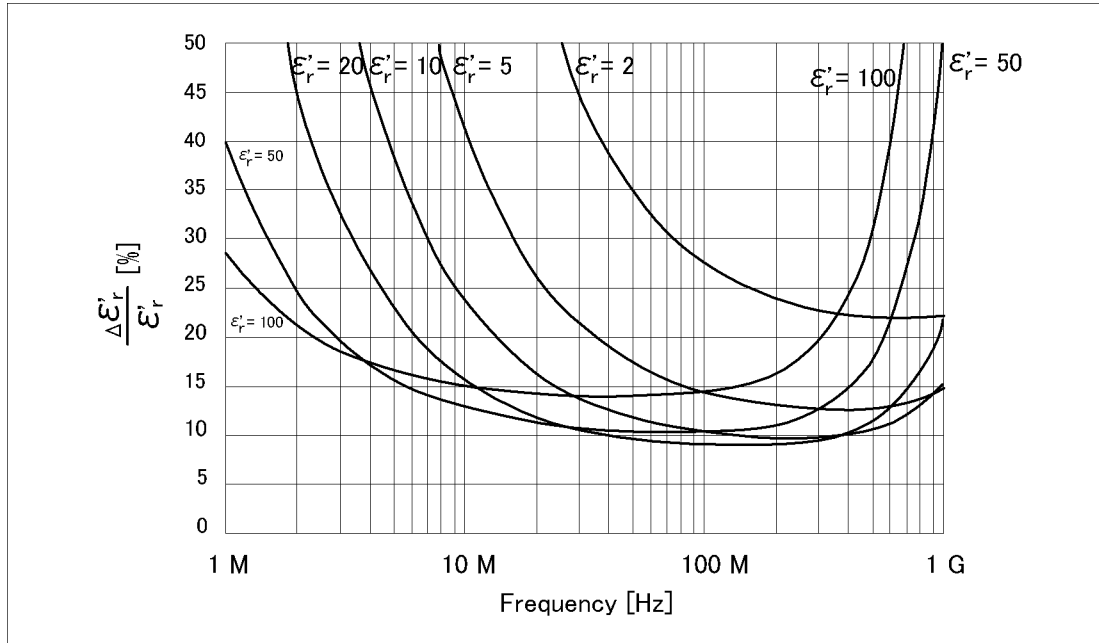
E4991aee0842

**Figure 11-37** Permittivity Accuracy ( $\frac{\Delta\epsilon'_r}{\epsilon'_r}$ ) vs. Frequency (at  $t = 1$  mm, typical)

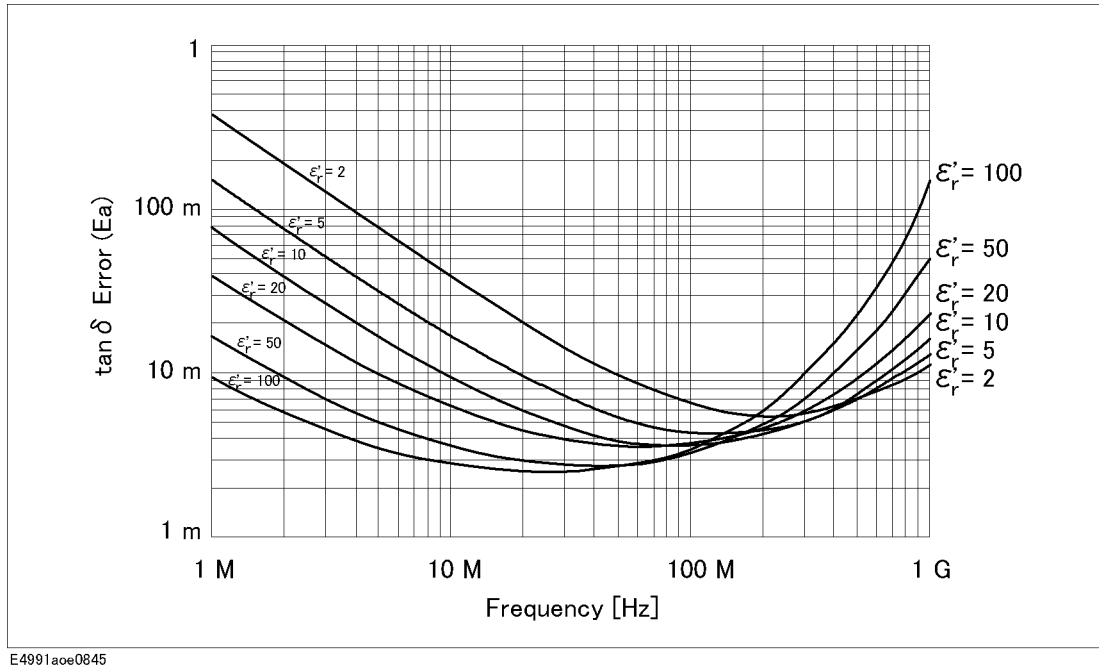


E4991aee0843

**Figure 11-38** Permittivity Accuracy ( $\frac{\Delta\epsilon'_r}{\epsilon'_r}$ ) vs. Frequency (at  $t = 3$  mm, typical)



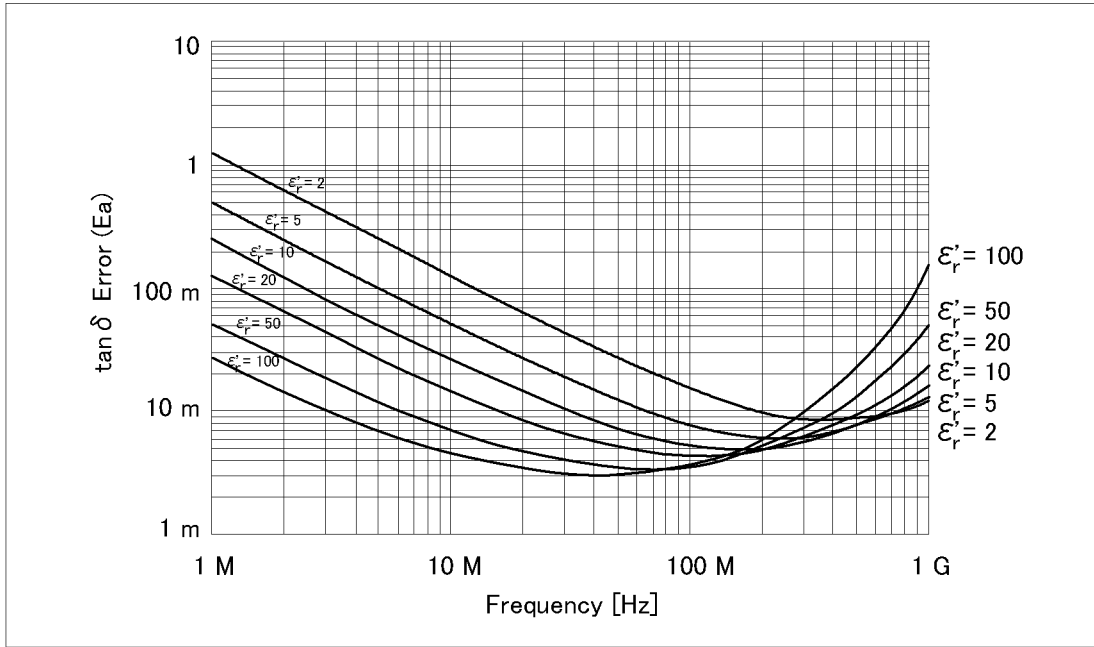
**Figure 11-39** Dielectric Loss Tangent ( $\tan\delta$ ) Accuracy vs. Frequency (at  $t = 0.3$  mm, typical)



**NOTE**

This graph shows only frequency dependence of  $E_a$  for simplification. The typical accuracy of  $\tan\delta$  is defined as  $E_a + E_b$ ; refer to “Typical permittivity measurement accuracy” on page 286.

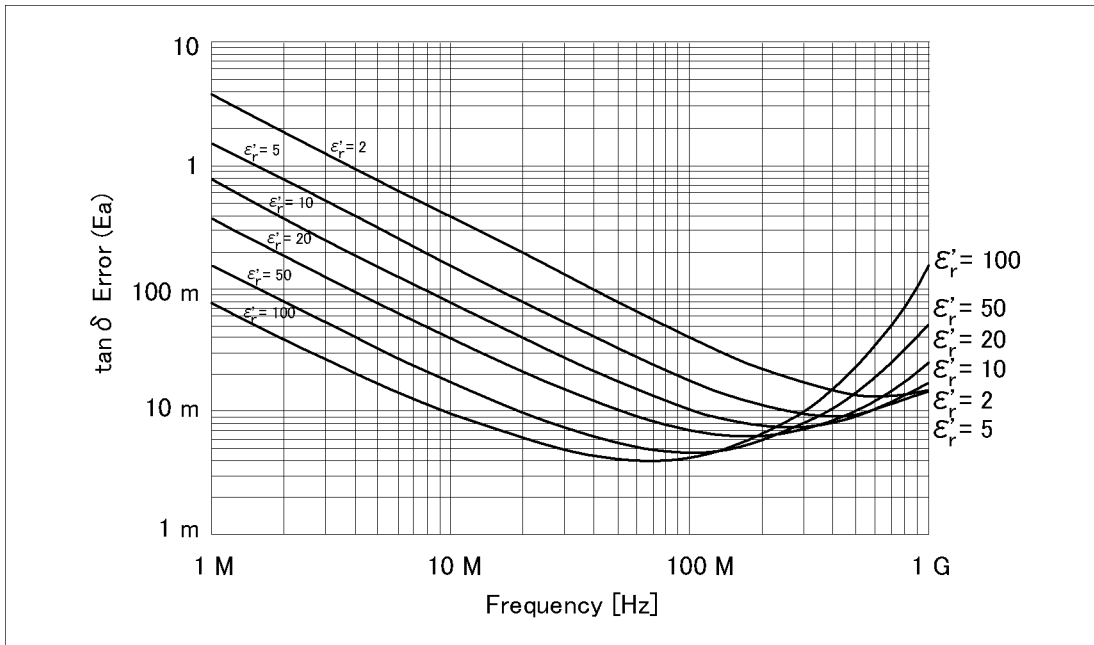
Figure 11-40 Dielectric Loss Tangent ( $\tan\delta$ ) Accuracy vs. Frequency (at  $t = 1$  mm, typical)



E4991a0e0846

**NOTE** This graph shows only frequency dependence of  $E_a$  for simplification. The typical accuracy of  $\tan\delta$  is defined as  $E_a + E_b$ ; refer to “Typical permittivity measurement accuracy” on page 286.

Figure 11-41 Dielectric Loss Tangent ( $\tan\delta$ ) Accuracy vs. Frequency (at  $t = 3$  mm, typical)

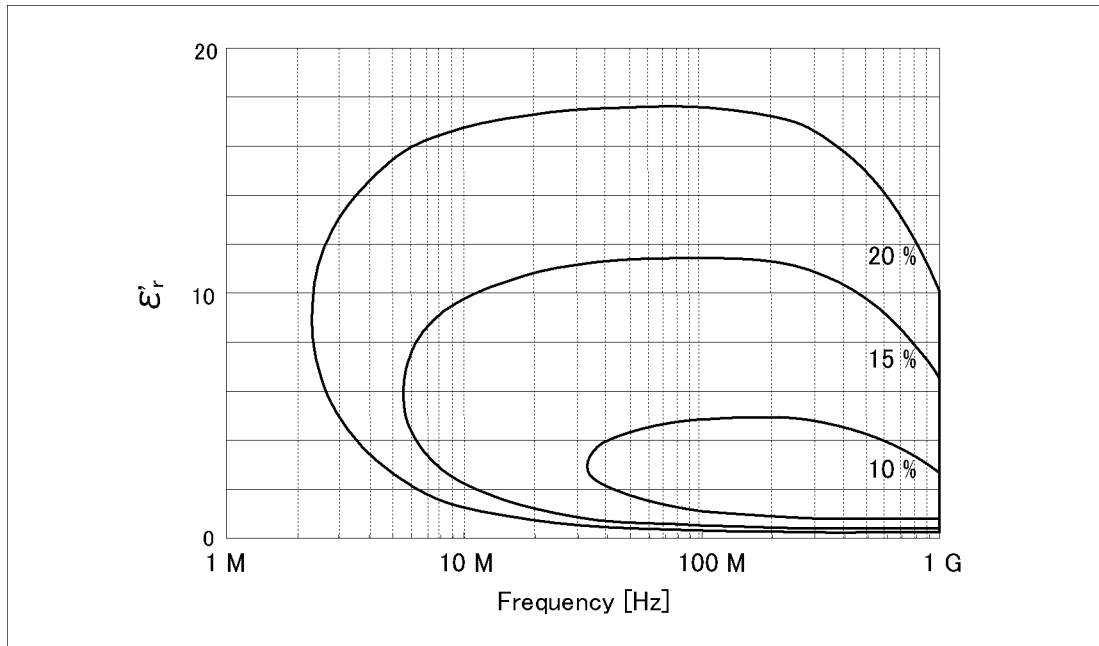


E4991a0e0847



**NOTE** This graph shows only frequency dependence of  $E_a$  for simplification. The typical accuracy of  $\tan\delta$  is defined as  $E_a + E_b$ ; refer to “Typical permittivity measurement accuracy” on page 286.

**Figure 11-42 Permittivity ( $\epsilon'_r$ ) vs. Frequency (at  $t = 0.3$  mm, typical)**



**Figure 11-43 Permittivity ( $\epsilon'_r$ ) vs. Frequency (at  $t = 1$  mm, typical)**

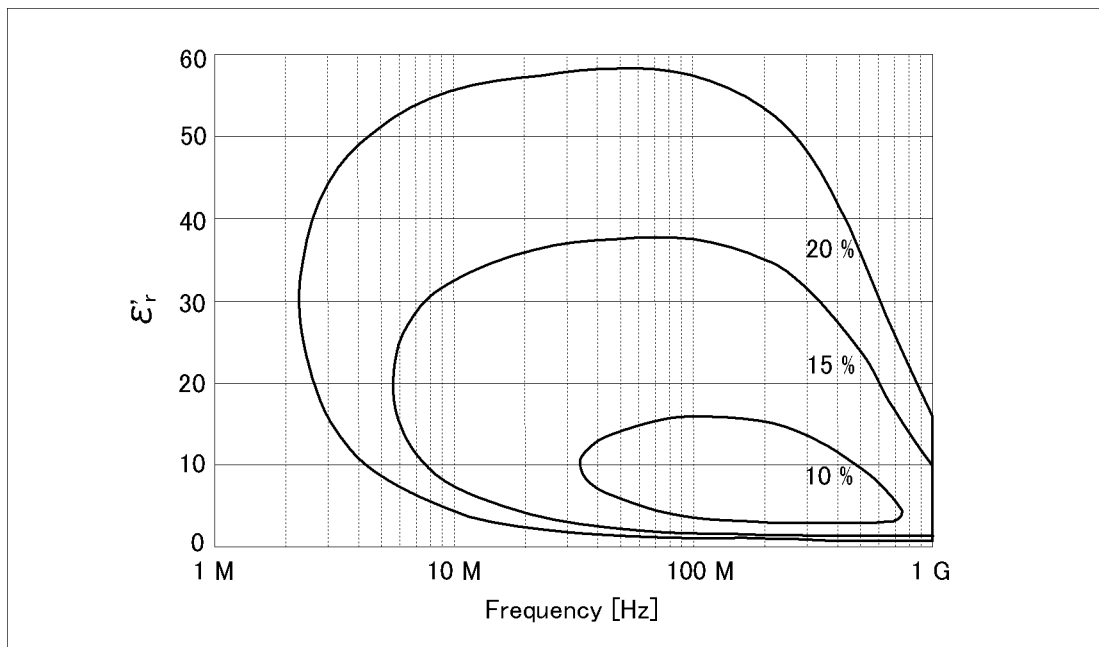
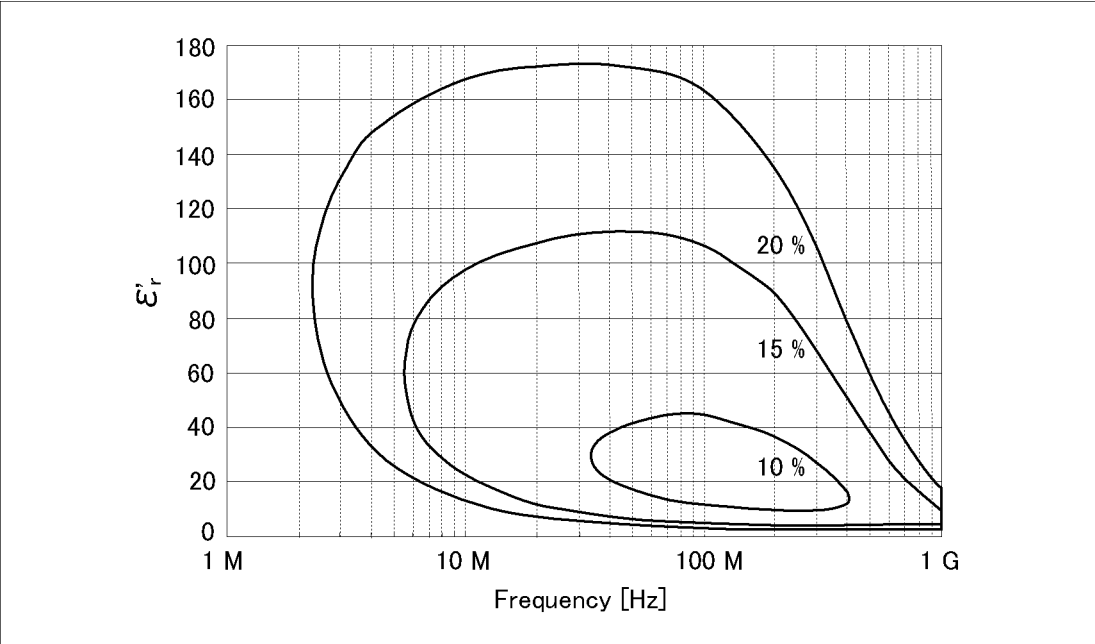


Figure 11-44 Permittivity ( $\epsilon'_r$ ) vs. Frequency (at  $t = 3$  mm, typical)

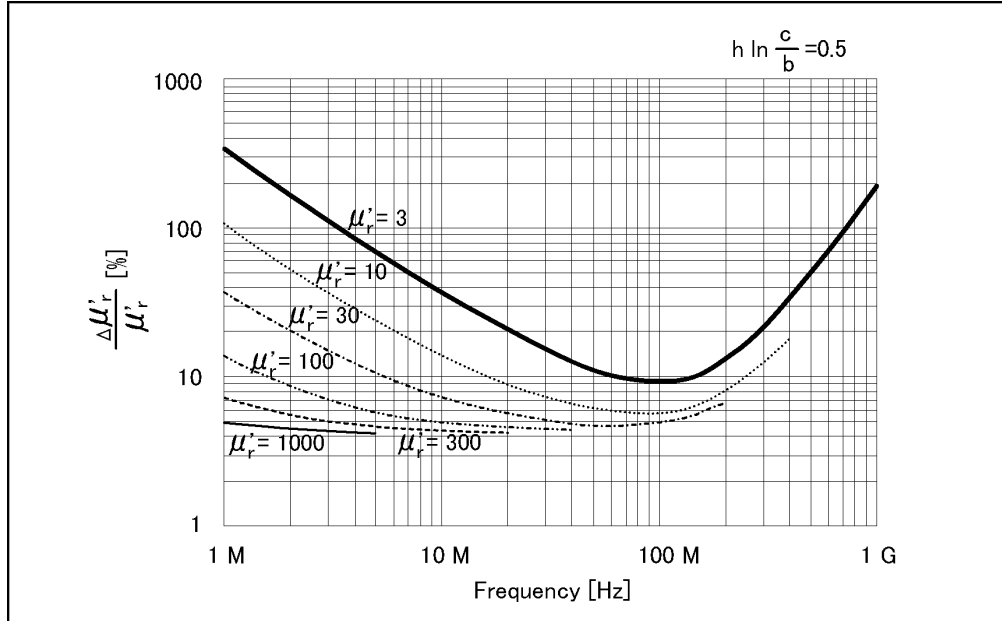


E4991a0e0856

Examples of Calculated Permeability Measurement Accuracy

Figure 11-45

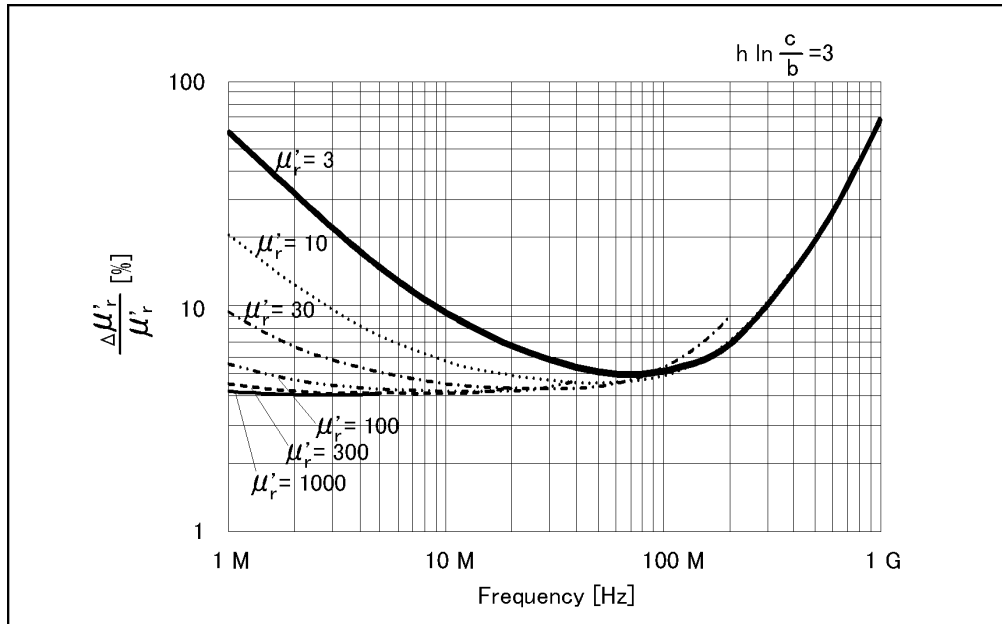
Permeability Accuracy ( $\frac{\Delta\mu'_r}{\mu'_r}$ ) vs. Frequency (at  $F = 0.5$ , typical)



E4991aee0848

Figure 11-46

Permeability Accuracy ( $\frac{\Delta\mu'_r}{\mu'_r}$ ) vs. Frequency (at  $F = 3$ , typical)



E4991aee0849

Figure 11-47 Permeability Accuracy ( $\frac{\Delta\mu'_r}{\mu'_r}$ ) vs. Frequency (at  $F = 10$ , typical)

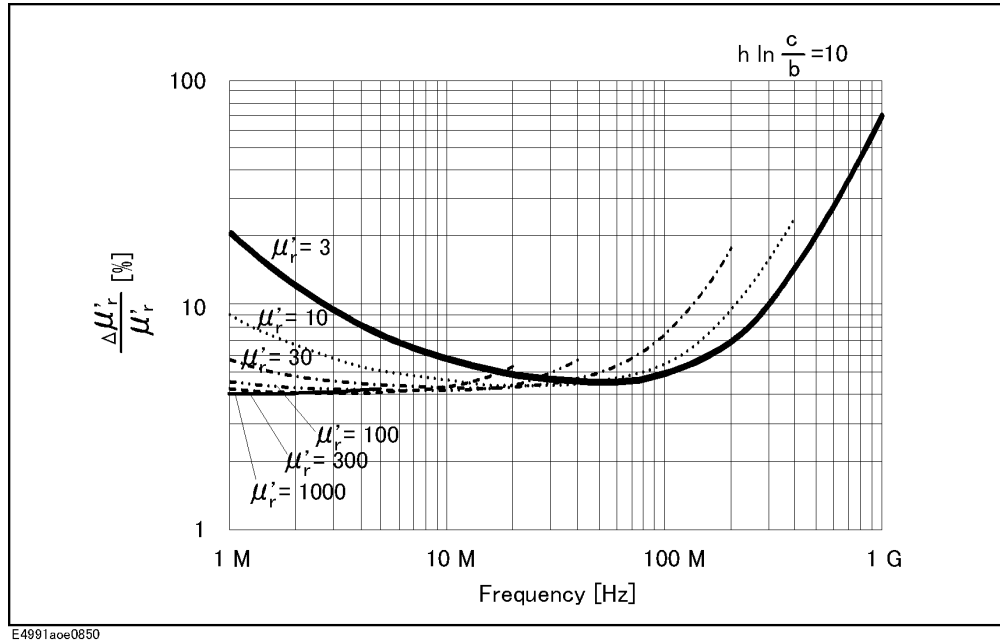
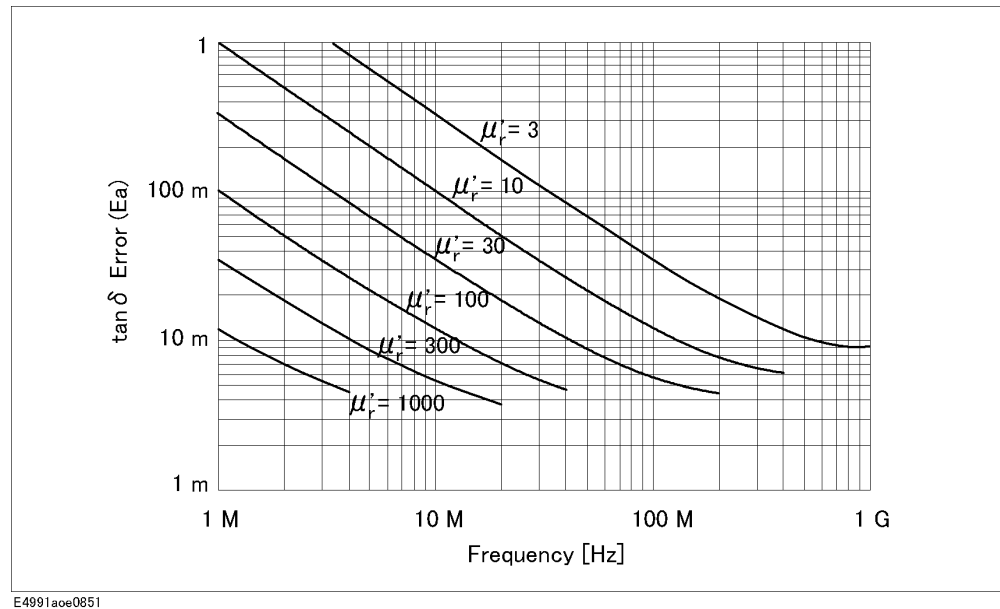
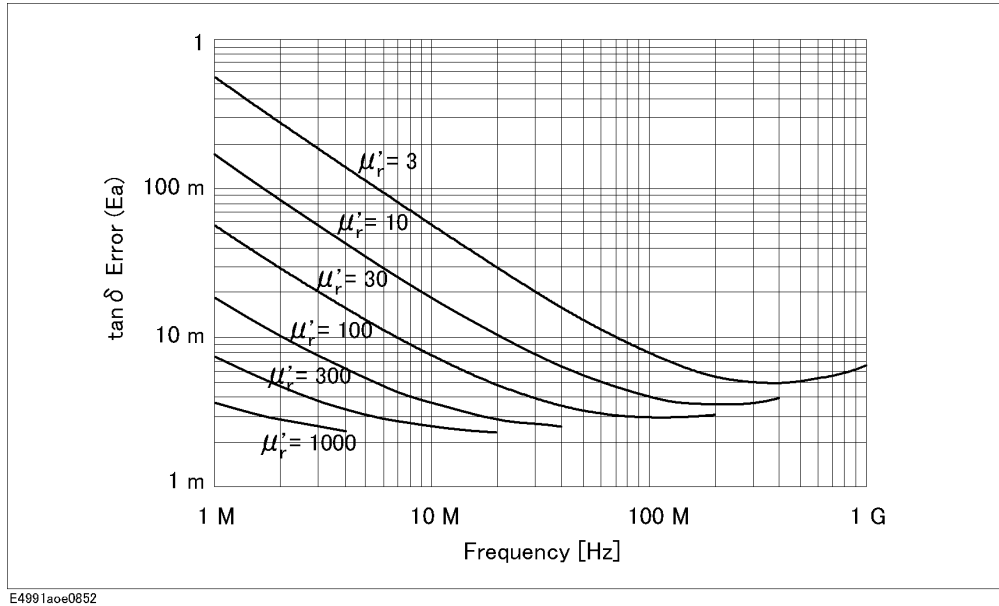


Figure 11-48 Permeability Loss Tangent ( $\tan\delta$ ) Accuracy vs. Frequency (at  $F = 0.5$ , typical)



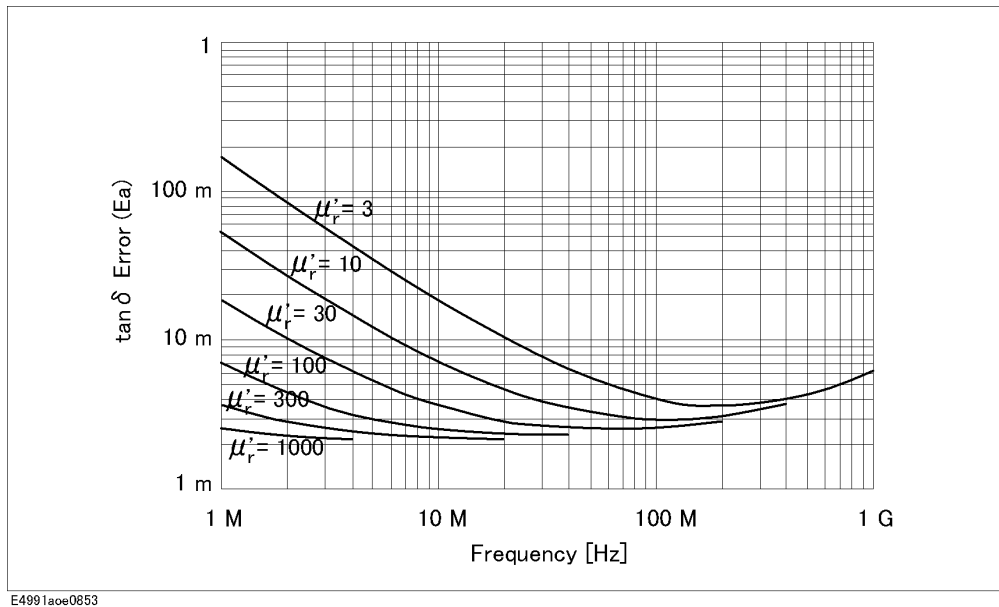
**NOTE** This graph shows only frequency dependence of  $E_a$  for simplification. The typical accuracy of  $\tan\delta$  is defined as  $E_a + E_b$ ; refer to “Typical permeability measurement accuracy” on page 287.

**Figure 11-49** Permeability Loss Tangent ( $\tan\delta$ ) Accuracy vs. Frequency (at  $F = 3$ , typical)



**NOTE** This graph shows only frequency dependence of  $E_a$  for simplification. The typical accuracy of  $\tan\delta$  is defined as  $E_a + E_b$ ; refer to “Typical permeability measurement accuracy” on page 287.

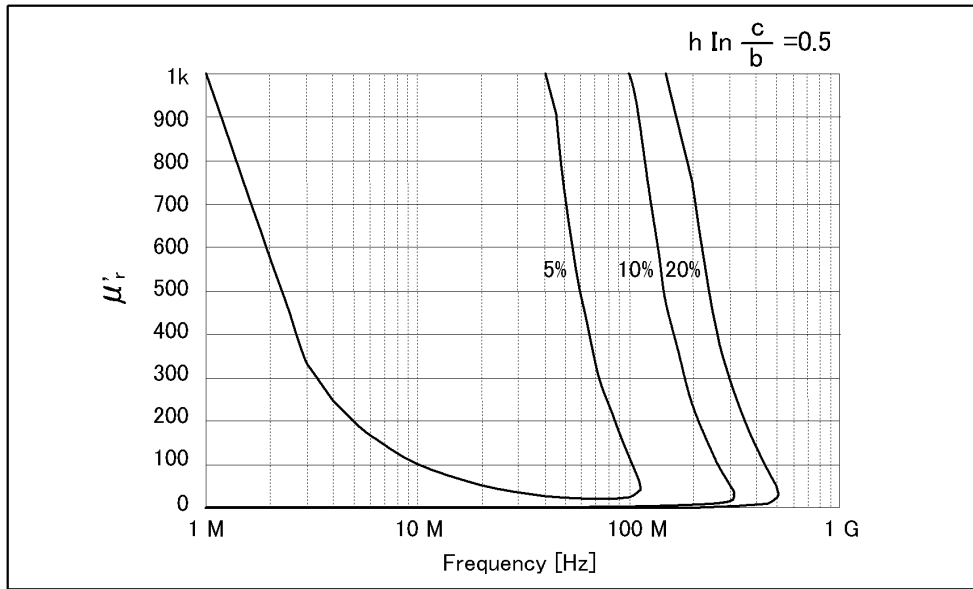
**Figure 11-50** Permeability Loss Tangent ( $\tan\delta$ ) Accuracy vs. Frequency (at  $F = 10$ , typical)



**NOTE** This graph shows only frequency dependence of  $E_a$  for simplification. The typical accuracy of  $\tan\delta$  is defined as  $E_a + E_b$ ; refer to “Typical accuracy of permeability

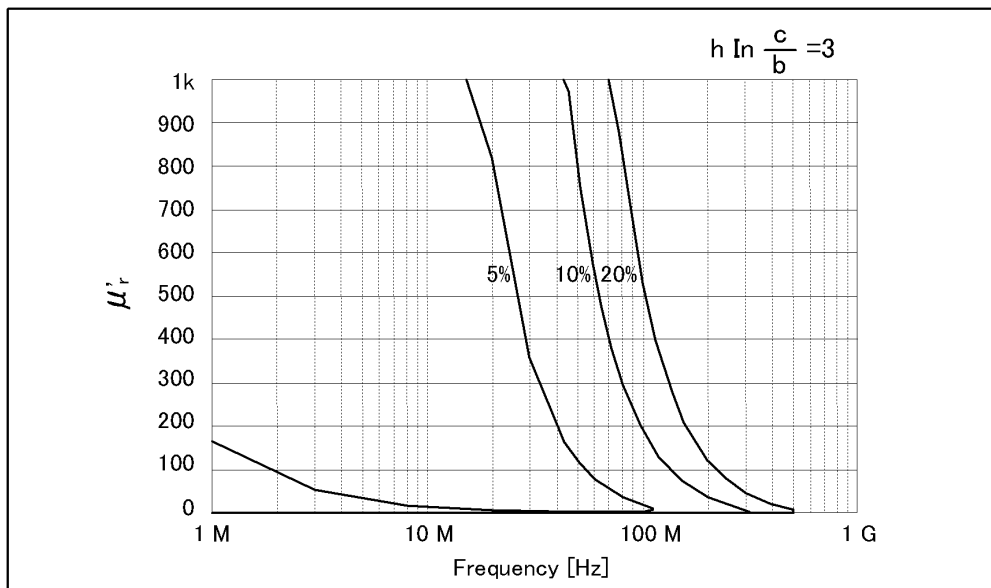
parameters” on page 265.

Figure 11-51 Permeability ( $\mu'_r$ ) vs. Frequency (at  $F = 0.5$ , typical)



e4991a0e0858

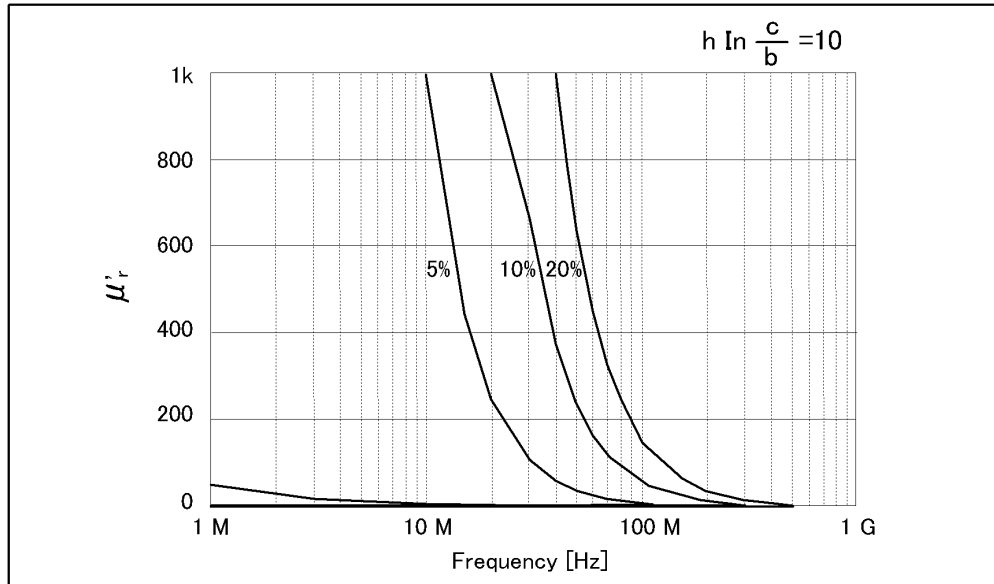
Figure 11-52 Permeability ( $\mu'_r$ ) vs. Frequency (at  $F = 3$ , typical)



e4991a0e0860

Figure 11-53

Permeability ( $\mu'_r$ ) vs. Frequency (at  $F = 10$ , typical)



e4991ace0859

### Typical Effects of Temperature Change on Permittivity Measurement Accuracy

When the temperature at the test port (7-mm connector) of the heat-resistant cable changes more than 5°C from the calibration temperature, the typical permittivity measurement accuracy involving temperature dependence effects (errors) is applied. The typical permittivity accuracy is represented by the sum of error due to temperature coefficient ( $T_c$ ), hysteresis error ( $T_c \times \Delta T_{max}$ ) and the accuracy at 23°C ± 5°C.

#### Typical accuracy of permittivity parameters

$$\begin{aligned} \epsilon_r' \text{ accuracy} & \qquad \qquad \qquad \pm(E_\epsilon + E_f + E_g) \text{ [%]} \\ \left( = \frac{\Delta\epsilon_{rm}'}{\epsilon_{rm}'} \right) & \end{aligned}$$

$$\begin{aligned} \text{Loss tangent accuracy of } \epsilon_r'' & \qquad \qquad \qquad \pm \frac{(E_\epsilon + E_f + E_g)}{100} \\ (= \Delta \tan \delta) & \end{aligned}$$

where,

$$E_\epsilon = \text{Permittivity measurement accuracy at } 23^\circ\text{C} \pm 5^\circ\text{C}$$

$$E_f = T_c \times \Delta T$$

$$E_g = T_c \times \Delta T_{max} \times 0.3$$

$$T_c = K_1 + K_2 + K_3$$

See Figure 11-54 through Figure 11-56 for the calculated value of  $T_c$

without temperature compensation

$$K_1 = 1 \times 10^{-6} \times (60 + 150 \times f)$$

$$K_2 = 3 \times 10^{-6} \times (1 + 10 \times f) \times \left( \frac{\epsilon_{rm}'}{t} \times \frac{1}{\left| 1 - \left( \frac{f}{f_0} \right)^2 \right|} + 10 \right) \times f$$

$$K_3 = 5 \times 10^{-3} \times (0.3 + 3 \times f) \times \frac{1}{\left( \frac{\epsilon_{rm}'}{t} \times \frac{1}{\left| 1 - \left( \frac{f}{f_0} \right)^2 \right|} + 10 \right) \times f}$$



with temperature compensation

$$K_1 = 1 \times 10^{-6} \times (60 + 150 \times f)$$

$$K_2 =$$

$$1 \text{ MHz} \leq f < 500 \text{ MHz} \quad 3 \times 10^{-6} \times (1 + 10 \times f) \times \left( \frac{\epsilon'_{rm}}{t} \times \frac{1}{\left| 1 - \left( \frac{f}{f_0} \right)^2 \right|} + 10 \right) \times f$$

$$500 \text{ MHz} \leq f \leq 1 \text{ GHz} \quad 3 \times 10^{-6} \times (5 + 2 \times f) \times \left( \frac{\epsilon'_{rm}}{t} \times \frac{1}{\left| 1 - \left( \frac{f}{f_0} \right)^2 \right|} + 10 \right) \times f$$

$$K_3 =$$

$$1 \text{ MHz} \leq f < 500 \text{ MHz} \quad 5 \times 10^{-3} \times (0.3 + 3 \times f) \times \frac{1}{\left( \frac{\epsilon'_{rm}}{t} \times \frac{1}{\left| 1 - \left( \frac{f}{f_0} \right)^2 \right|} + 10 \right) \times f}$$

$$500 \text{ MHz} \leq f \leq 1 \text{ GHz} \quad 5 \times 10^{-3} \times (1.5 + 0.6 \times f) \times \frac{1}{\left( \frac{\epsilon'_{rm}}{t} \times \frac{1}{\left| 1 - \left( \frac{f}{f_0} \right)^2 \right|} + 10 \right) \times f}$$

$$f = \text{Measurement frequency [GHz]}$$

$$f_0 = \frac{13}{\sqrt{\epsilon'_r}} \text{ [GHz]}$$

$$t = \text{Thickness of MUT (material under test) [mm]}$$

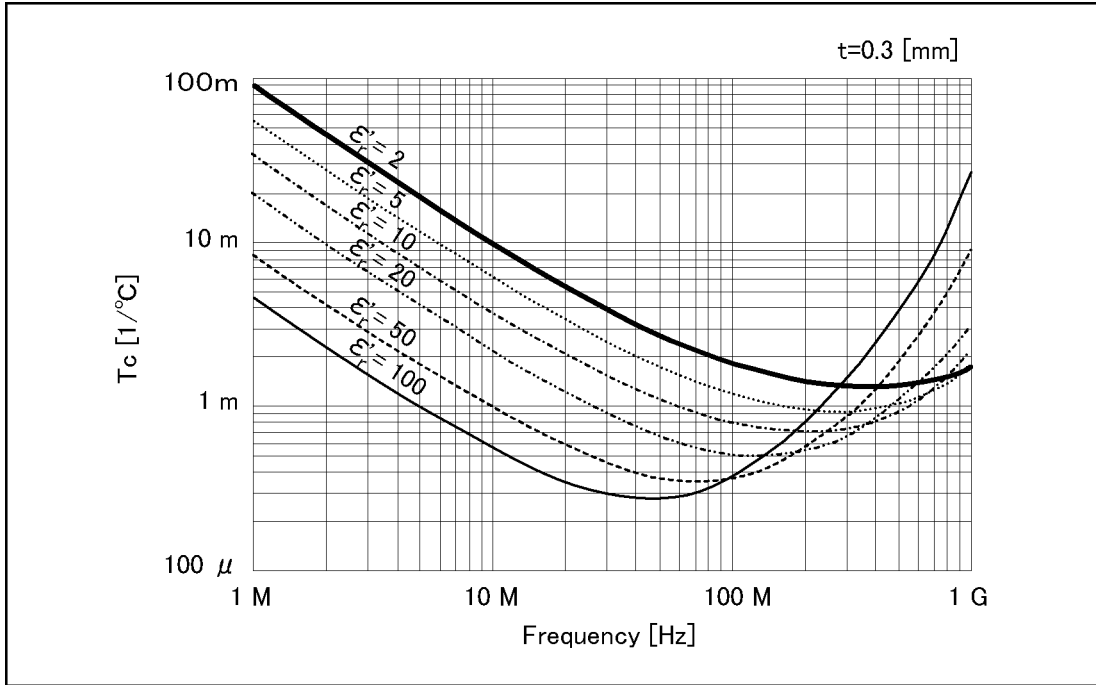
$$\epsilon'_{rm} = \text{Measured value of } \epsilon'_r$$

$$\Delta T = \text{Difference of measurement temperature from calibration temperature}$$

$$\Delta T_{max} = \text{Maximum temperature change (°C) at test port from calibration temperature after the calibration is performed.}$$

Figure 11-54

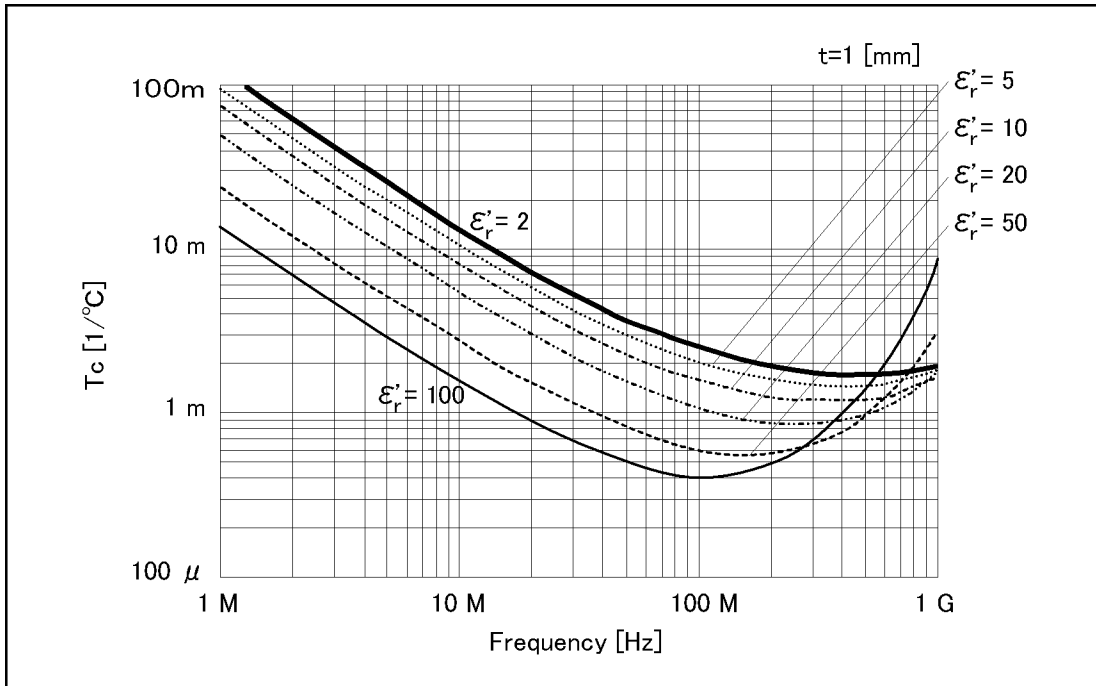
Typical Frequency Characteristics of Temperature Coefficient of  $\epsilon'_r$   
(Thickness = 0.3 mm)



e4991a0e0837

Figure 11-55

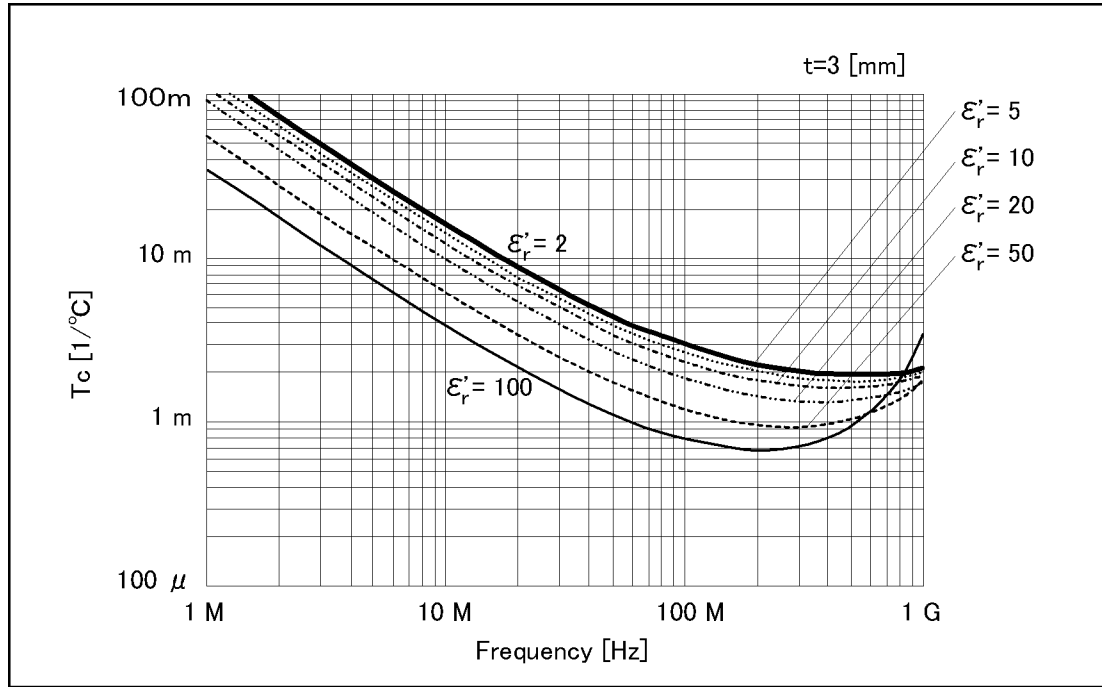
Typical Frequency Characteristics of Temperature Coefficient of  $\epsilon'_r$   
(Thickness = 1 mm)



e4991a0e0838

Figure 11-56

Typical Frequency Characteristics of Temperature Coefficient of  $\epsilon'_r$   
(Thickness = 3 mm)



e4991a0e0836

### Typical Effects of Temperature Change on Permeability Measurement Accuracy

When the temperature at the test port (7-mm connector) of the heat-resistant cable changes more than 5°C from the calibration temperature, the typical permeability measurement accuracy involving temperature dependence effects (errors) is applied. The typical permeability accuracy is represented by the sum of error due to temperature coefficient ( $T_c$ ), hysteresis error ( $T_c \times T_{max}$ ) and the accuracy at 23°C ± 5°C.

$$\begin{aligned} \mu_r' \text{ accuracy} & \pm(E_\mu + E_h + E_i) \text{ [%]} \\ \left( = \frac{\Delta\mu'_{rm}}{\mu'_{rm}} \right) & \end{aligned}$$

$$\begin{aligned} \text{Loss tangent accuracy of } \mu_r & \pm \frac{(E_\mu + E_h + E_i)}{100} \\ (= \Delta \tan \delta) & \end{aligned}$$

where,

$$E_\mu = \text{Permeability measurement accuracy at } 23^\circ\text{C} \pm 5^\circ\text{C}$$

$$E_h = T_c \times \Delta T$$

$$E_i = T_c \times \Delta T_{max} \times 0.3$$

$$T_c = K_4 + K_5 + K_6$$

See Figure 11-57 through Figure 11-59 for the calculated value of  $T_c$  without temperature compensation

$$K_4 = 1 \times 10^{-6} \times (60 + 150 \times f)$$

$$K_5 = 1 \times 10^{-2} \times (1 + 10 \times f) \times \frac{1 - 0.01 \times \{F \times (\mu'_{rm} - 1) + 10\} \times f^2}{\{F \times (\mu'_{rm} - 1) + 20\} \times f}$$

$$K_6 = 2 \times 10^{-6} \times (0.3 + 3 \times f) \times \frac{\{F \times (\mu'_{rm} - 1) + 20\} \times f}{1 - 0.01 \times \{F \times (\mu'_{rm} - 1) + 10\} \times f^2}$$

with temperature compensation

$$K_4 = 1 \times 10^{-6} \times (60 + 150 \times f)$$

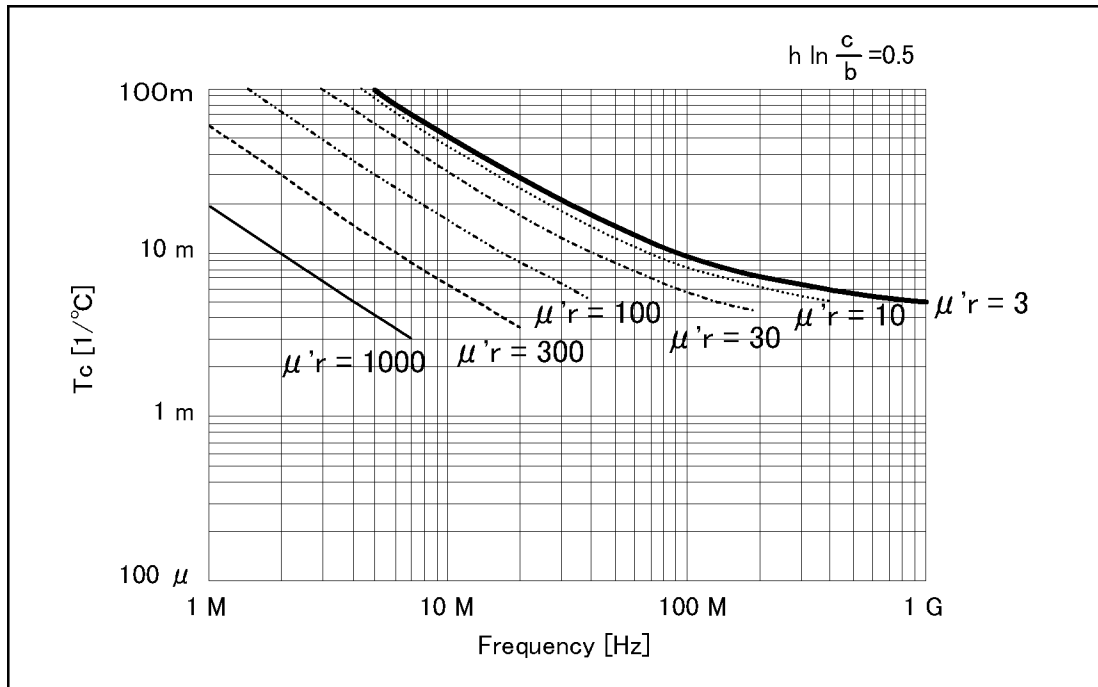
$$K_5 =$$

$$1 \text{ MHz} \leq f < 500 \text{ MHz} \quad 1 \times 10^{-2} \times (1 + 10 \times f) \times \frac{1 - 0.01 \times \{F \times (\mu'_{rm} - 1) + 10\} \times f^2}{\{F \times (\mu'_{rm} - 1) + 20\} \times f}$$

$$500 \text{ MHz} \leq f \leq 1 \text{ GHz} \quad 1 \times 10^{-2} \times (5 + 2 \times f) \times \frac{1 - 0.01 \times \{F \times (\mu'_{rm} - 1) + 10\} \times f^2}{\{F \times (\mu'_{rm} - 1) + 20\} \times f}$$

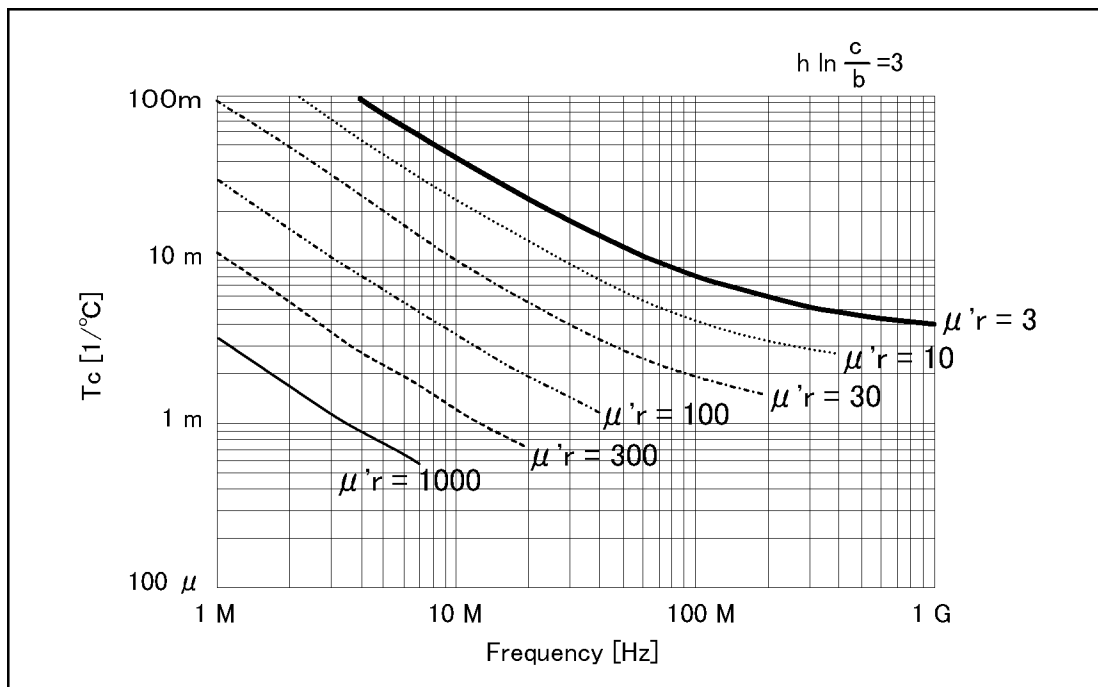
$K_6 =$	
$1 \text{ MHz} \leq f < 500 \text{ MHz}$	$2 \times 10^{-6} \times (0.3 + 3 \times f) \times \frac{\{F \times (\mu'_{rm} - 1) + 20\} \times f}{\left[1 - 0.01 \times \{F \times (\mu'_{rm} - 1) + 10\} \times f^2\right]}$
$500 \text{ MHz} \leq f \leq 1 \text{ GHz}$	$2 \times 10^{-6} \times (1.5 + 0.6 \times f) \times \frac{\{F \times (\mu'_{rm} - 1) + 20\} \times f}{\left[1 - 0.01 \times \{F \times (\mu'_{rm} - 1) + 10\} \times f^2\right]}$
$f =$	Measurement frequency [GHz]
$F =$	$h \ln \frac{c}{b}$ [mm]
$h =$	Height of MUT (material under test) [mm]
$b =$	Inner diameter of MUT [mm]
$c =$	Outer diameter of MUT [mm]
$\mu'_{rm} =$	Measured value of $\mu'_r$
$\Delta T =$	Difference of measurement temperature from calibration temperature
$\Delta T_{max} =$	Maximum temperature change (°C) at test port from calibration temperature after the calibration is performed.

Figure 11-57 Typical Frequency Characteristics of Temperature Coefficient of  $\mu'_r$  (at  $F = 0.5$ )



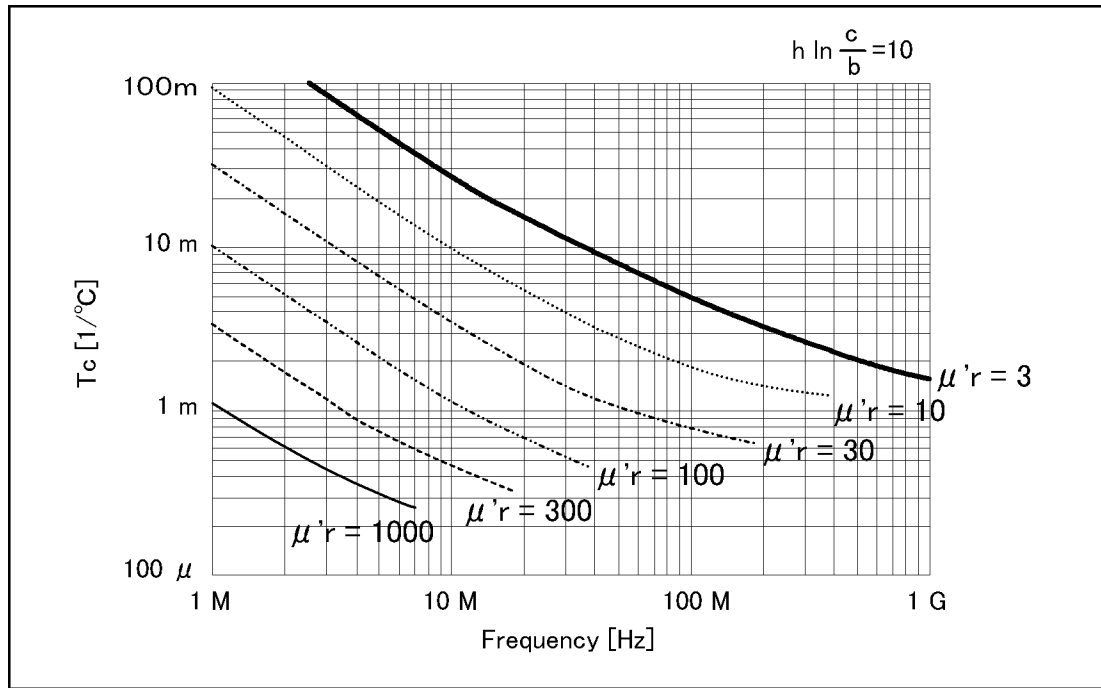
e4991a0e0840

Figure 11-58 Typical Frequency Characteristics of Temperature Coefficient of  $\mu'_r$  (at  $F = 3$ )



e4991a0e0841

Figure 11-59 Typical Frequency Characteristics of Temperature Coefficient of  $\mu'_r$  (at  $F = 10$ )



e4991a0e0839





---

## **A** **Manual Changes**

This appendix contains the information required to adapt this manual to versions or configurations of the E4991A manufactured earlier than the current printing date of this manual. The information in this manual applies directly to E4991A units having the serial number printed on the title page of this manual.

---

## Manual Changes

To adapt this manual to your E4991A, refer to Table A-1 and Table A-2.

**Table A-1** Manual Changes by Serial Number

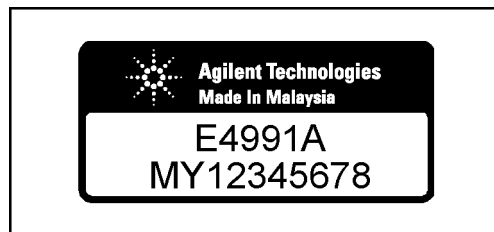
Serial Prefix or Number	Make Manual Changes
JP1KH	Change 1
JP2KH or MY432	Change 2, Change 3, Change 4, Change 5

**Table A-2** Manual Changes by Firmware Version

Version	Make Manual Changes
2.0x	Change 6

Agilent Technologies uses a two-part, ten-character serial number that is stamped on the serial number plate (Figure A-1). The first five characters are the serial prefix and the last five digits are the suffix.

**Figure A-1** Serial Number Plate



e4991aaj6001

## Change 6

This function is available when the volume label on the C-drive is IG201 or higher.

- o User recovery function

## Change 5

When the serial number prefix is JP2KH and MY432, change the description of “Configuring the Network” on page 216 to the following one.

### LAN Setup

Set up your LAN to incorporate the E4991A after consulting with your network administrator.

### Setup procedure

---

#### NOTE

Do not make a physical connection of the E4991A to your LAN before completing proper LAN setup (through completion of Step 3). Connecting the E4991A to a LAN in an inappropriate setup could cause trouble for the entire network.

Use the mouse or keyboard for the procedure described below.

---

#### Step 1. Exit from the E4991A system program

- a. Click **System - Exit** from the menu bar. This opens the **Enter Password to exit** dialog box (Figure A-7).

Figure A-2

#### Enter Password to exit dialog box

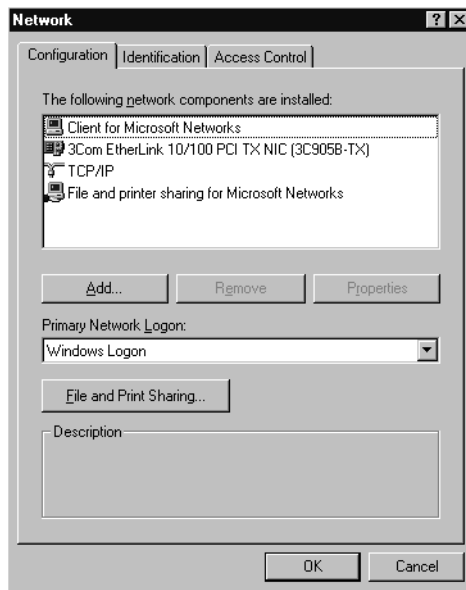


- b. Enter the password: **e4991a** into the **Password** box by using the character input dialog box that appears by clicking the **Keyboard...** button or by using the external keyboard.
- c. Exit from the E4991A system by clicking the **OK** button.

#### Step 2. Set up the IP address/subnet mask

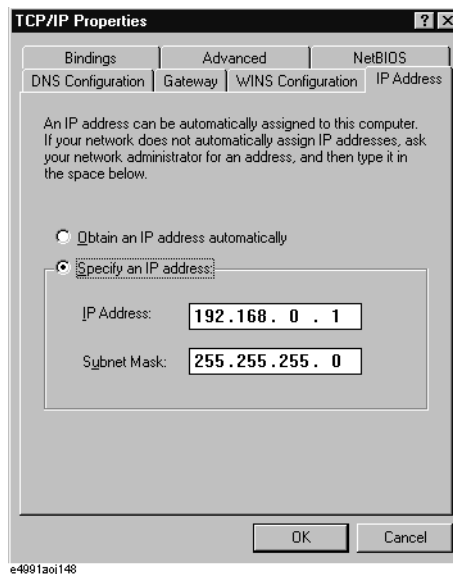
- a. Open the shortcut menu by right-clicking the **Network Neighborhood** icon on the desktop and click **Properties**. This opens up the **Network** dialog box (Figure A-9).

Figure A-3 Network dialog box



- b. Click the **TCP/IP** icon in the **Configuration** tab to select it.
- c. Click the **Properties** button. This opens the **TCP/IP Properties** dialog box (Figure A-11).

Figure A-4 TCP/IP Properties dialog box (IP Address tab)



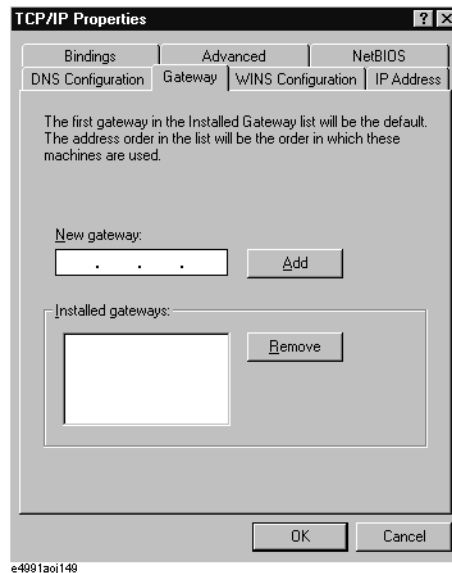
- d. Click the **Specify an IP address** option button in the **IP Address** tab to select it and input your IP address in the **IP Address** box and your subnet mask in the **Subnet Mask** box (overwrite the initial values) to assign a specific IP address and subnet mask.

Click the **Obtain an IP address automatically** option button to select it if an IP address can be obtained automatically (when a DHCP server is available). In this case, setup of the gateway address in Step 3 is not necessary.

**Step 3. Set up a gateway address**

- a. Click the **Gateway** tab (Figure A-5) to open it.

**Figure A-5 TCP/IP Properties dialog box (Gateway tab)**



- b. Input the correct gateway address in the **New gateway** box and click the **Add** button.

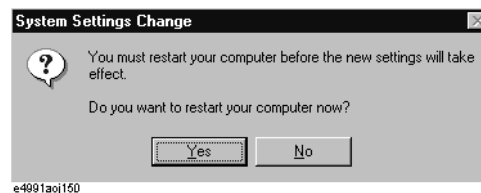
**Step 4. Perform other network setup**

If other network setup is necessary, perform it in the same manner as with a conventional computer running Windows 98™.

**Step 5. Shut down the E4991A**

- a. Click the **OK** button to close the **TCP/IP Properties** dialog box.
- b. Click the **OK** button to close **Network** dialog box. This opens the **System Setup Change** dialog box (Figure A-6).

**Figure A-6 System Setup Change dialog box**



- c. Click the **Yes** button to restart the E4991A.

**NOTE**

Shut down the E4991A by following the procedure below if you click the **No** button by mistake.

1. Click **Start - Shut Down...**
2. Click the **Shut down** button in the **Shut Down Windows** dialog box to select it.
3. Click the **OK** button

**Step 6. Connect LAN cable and turn power on**

## Manual Changes

### Manual Changes

- a. Connect the E4991A to a LAN with a LAN cable after the power to the E4991A has been turned off.
- b. Press the Standby switch once to reset the switch and then press the switch once more to turn the power on.

### Change 4

When the serial number prefix is JP2KH and MY432, change the description of “System Recovery” on page 204 to the following one.

#### System Recovery

Performing system recovery will allow you to reset the Windows operating system and the firmware of the E4991A to the state when you purchased\*<sup>1</sup>.

If, for some reason, the Windows operating system or firmware failed and cannot be started normally or operation after startup is unstable, execute system recovery.

**Notes on executing system recovery** Performing system recovery causes the following:

- o The following settings of the E4991A are initialized.
  - Network settings
  - GPIB settings
  - Printer settings
- o If the firmware has been updated after purchasing the E4991A, the firmware when you purchased the product\*<sup>1</sup> is recovered.
- o If you installed any driver software for the supported printer, it will be deleted.

Files you created using the save function are not affected, but we recommend backing them up before executing system recovery for precautionary purposes.

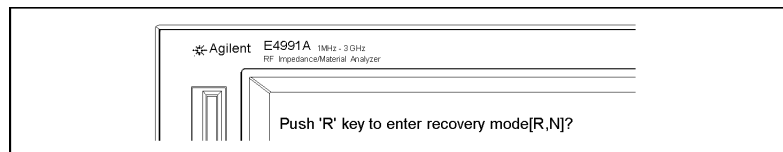
#### Procedure to execute system recovery

---

#### NOTE

You need the keyboard for this operation.

- Step 1.** Shut down the E4991A.
- Step 2.** Connect the keyboard to the E4991A.
- Step 3.** Press the standby switch of the E4991A to turn it on.
- Step 4.** When the message in the figure below appears on the screen following the Agilent's logo screen, immediately press **[R]** on the keyboard.



e4991a0j221

---

\*1.If the hard disk failed and has been replaced after purchase, the state when the replacement was performed is recovered.

---

**NOTE**

Watch the message carefully because after several seconds it will be replaced with the next screen. Note that this is automatically done with no key operations.

If the above message does not appear, the E4991A is at fault; contact your local Agilent customer center listed at the end of this manual or the distributor from which you purchased the instrument.

---

**Step 5.** When "Recover Hard disk (C drive) [Y, N]?" is displayed, press  on the keyboard. If you want to quit the system recovery, press  to start up the E4991A as usual.

**Step 6.** The following message appears. This is the final confirmation message asking whether you want to start the system recover. Press  on the keyboard to start the system recovery. If you want to quit the system recovery, press  to start up the E4991A as usual.

```
=====
SYSTEM RECOVERY
=====
```

```
This process will recover the system drive (C:) of this
instrument to the factory-shipment state. It takes about 10 minutes.
Please refer to the Operation Manual for more information.
```

```
This is the last chance to quit the recovery process
```

```
Continue [Y,N]?
```

**Step 7.** The system recovery will complete in about 10 minutes. The following message is displayed during the system recovery.

```
=====
SYSTEM RECOVERY IN PROGRESS...
=====
```

```
System recovery in progress. It takes about 10 minutes.
Please DO NOT TURN THE POWER OFF DURING THIS TIME.
```

---

**CAUTION**

**Never turn off the power during the system recovery because doing so may cause serious damage to the E4991A.**

---

**Step 8.** When the system recovery is completed, the following message appears below the above message indicating that the system recovery is in progress.

```
"Recovery Completed !"
"Please any key and then restart system."
```

Now the system recovery of the E4991A is complete.

---

**NOTE**

If the problem persists even after executing system recovery, the E4991A is at fault; contact your local Agilent customer center listed at the end of this manual or the distributor from which you purchased the instrument.

---

### Change 3

When the serial number prefix is JP2KH and MY432, change the description of “Procedure for setting the internal clock” on page 197 to the following one.

#### Setting the Internal Clock

The E4991A has a built-in clock for the date and time. This internal clock is used for recording the date and time of when internal data or a VBA program is saved as a file.

#### Procedure for setting the internal clock

---

**NOTE** Use the mouse or keyboard for the following operation.

---

#### Step 1. Exiting the E4991A system program.

- a. Click **System - Exit** in the menu bar.

The **Enter Password to exit** dialog box (Figure A-7) opens.

**Figure A-7** Enter Password to exit dialog box



- b. Click the **Keyboard...** button and use the displayed character entry dialog box or use an external keyboard to enter the password **e4991a** in the **Password** box.
- c. Click the **OK** button to exit the E4991A system.

#### Step 2. Setting the date and time.

- a. Click the **Start** button in the lower-left corner of the screen and select **Settings - Control Panel** (Figure A-8). This operation will open the **Control Panel** window (Figure A-9).

**Figure A-8** Select Control Panel from the start menu.

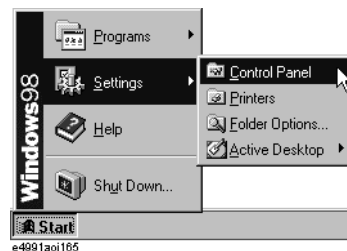


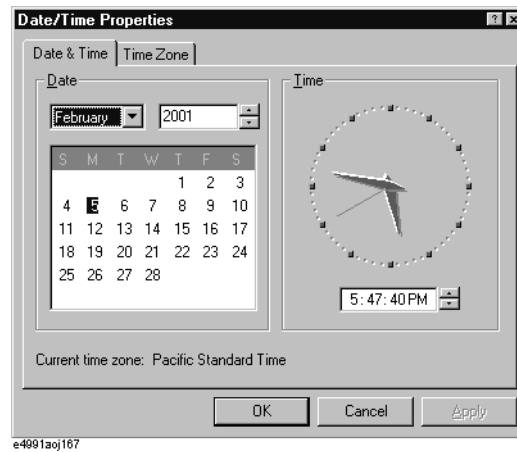


Figure A-9 Control Panel window



b. After double-clicking the **Date/Time** icon, the Date/Time Properties dialog box (Figure A-10) will open.

Figure A-10 Date/Time Properties dialog box



c. Set the date and time in the **Date** and **Time** areas, respectively.  
d. Click the **Time Zone** tab.

Figure A-11 Date/Time Properties dialog box (Time Zone tab)



## Manual Changes

### Manual Changes

- e. Click the **t** button to select the time zone.
- f. If you want to set daylight savings time automatically, enter a check mark (✓) in the **Automatically adjust clock for daylight saving changes** check box.
- g. Click the **OK** button.

---

#### NOTE

When you want to execute a setting change for the mouse at the same time, proceed to Step 3 on page 200 for “Setting the Mouse” (doing both procedures at this time will require you to restart the E4991A only once).

- h. Click the **x** button in the **Control Panel** window to close the window.

#### Step 3. Shutting down and restarting the E4991A.

- a. Click **Start - Shut Down...** (Figure A-12).

Figure A-12

Click **Start - Shut Down**.



- b. Click the **Shut down** option button and then click the **OK** button (Figure A-13). The E4991A will shut down.

Figure A-13

Shut down dialog box



- c. When the power of the E4991A is off, press the Standby switch once to activate the switch and then press it again to turn on the power.

## Change 2

When the serial number prefix is JP2KH and MY432, change the description of ÅgSetup and Confirmation of GPIBÅh on page xxx to the following one.

### Setup and Confirmation of GPIB

This section describes the setup procedures of the interfaces required for using the E4991A GPIB (General Purpose Interface Bus). Refer to the “Programming Manual” for the concept and execution procedures of automatic measurement using GPIB.

When the E4991A is used in a GPIB system, it is necessary to select the E4991A as a

system controller or to use it in addressable-only mode. Only one unit can be set up as the system controller in an automatic measurement system to control the entire system. On the other hand, instruments set in addressable mode can be controlled by using addresses from other instruments. The addresses in system controller mode or in addressable-only mode are set differently depending on the mode in use.

**NOTE**

The E4991A's GPIB function (including setups) is available only from the local user interface. For details on the local user interface and remote user interface, refer to "Using Remote User Interface" on page 228.

**Operation procedure**

**Step 1. Confirmation and change of control mode**

- a. Open the shortcut menu by right-clicking and select **System** (Or press **[System]**).
- b. Click the **GPIB Setup Menu** button.
- c. Confirm the setup control mode by the indication on the **Control Mode** button. Click the button to toggle the control modes. Proceed to step 2 when the desired control mode is confirmed.

Indication on Control Mode button	Control mode setup
Control Mode: [System Controller]	System controller mode
Control Mode: [Addressable Only]	Addressable-only mode

A dialog box (Figure A-14) pops up after the button is clicked.

**Figure A-14**

**E4991A Dialog box**



- d. Click the **OK** button in the dialog box.

**Step 2. Confirmation and change of address**

- a. The address in the addressable-only mode and the address in the system controller mode are indicated in the **Address: E4991A** box and **Address: Controller** box, respectively. Open the address box you want to change by clicking it and then select a new address by clicking one. Proceed to step 3 if no change is required.

A dialog box (Figure A-14) pops up when the address is changed.

- b. Click **OK** button in the dialog box.

**Step 3. Shutting down and restarting the E4991A**

Execute the procedure below if you changed the control mode or the address.

- a. Shut down the E4991A by pressing "1. Standby switch" on page 23.
- b. Turn on the E4991A by again pressing "1. Standby switch" on page 23.

**NOTE**

The new control mode or address after changing does not become valid until the E4991A has been shutdown and restarted.

**Change 1**

When the serial number prefix is JP1KH, change the description of “Procedure to execute system recovery” on page 205 to the following one.

**Procedure to execute system recovery**

**Step 1.** Prepare the items shown below.

- System recovery disk (3.5 inch floppy disk) attached to the E4991A
- Keyboard (Connect to the E4991A)

**Step 2.** Shut down the E4991A.

**Step 3.** Insert the system recovery disk in the floppy disk drive of the E4991A.

**Step 4.** Turn on the E4991A by pressing the Standby switch and press **[F]** immediately after Figure A-15 is displayed.

**Figure A-15**

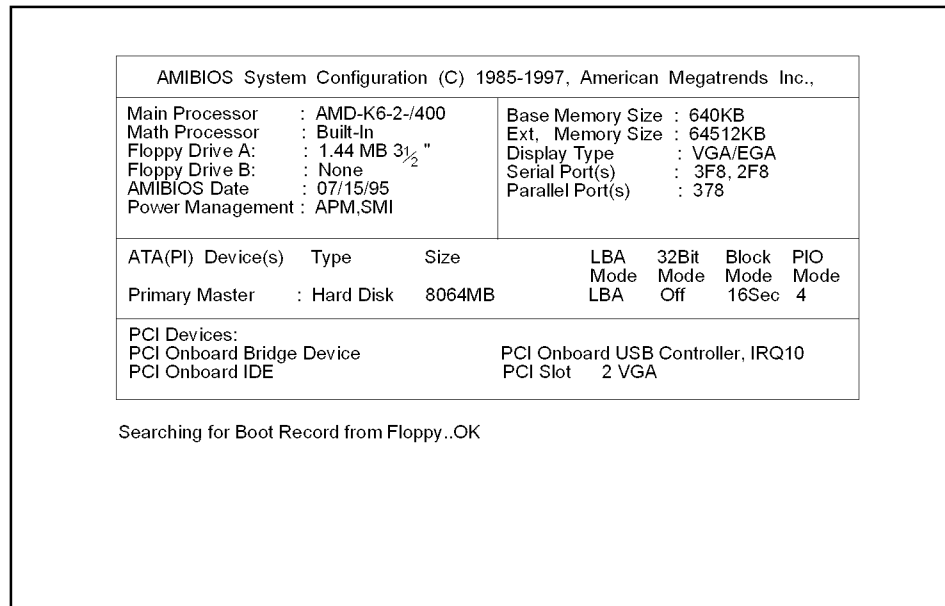
**Initial Power-on Screen Display**

AMIBIOS System Configuration (C) 1985-1997, American Megatrends Inc.,							
Main Processor	:	AMD-K6-2-/400		Base Memory Size	:	640KB	
Math Processor	:	Built-In		Ext. Memory Size	:	64512KB	
Floppy Drive A:	:	1.44 MB 3 1/2"		Display Type	:	VGA/EGA	
Floppy Drive B:	:	None		Serial Port(s)	:	3F8, 2F8	
AMIBIOS Date	:	07/15/95		Parallel Port(s)	:	378	
External Cache	:	512KB,Disabled		Power Management	:	APM, SMI	
ATA(Pi) Device(s)	Type	Size		LBA Mode	32Bit Mode	Block Mode	PIO Mode
Primary Master	: Hard Disk	8064MB		LBA	Off	16Sec	4
PCI Devices:				PCI Onboard USB Controller, IRQ10			
PCI Onboard Bridge Device				PCI Slot			
PCI Onboard IDE				2 VGA			

e4991aoj194

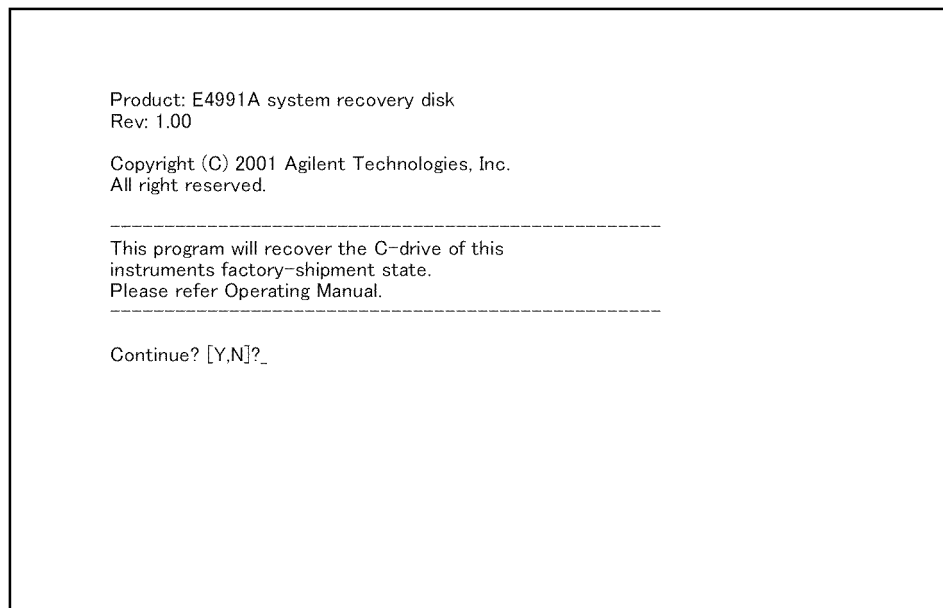
The contents of the system recovery disk are loaded while Figure A-16 is displayed. After a short time, the system recovery start screen (Figure A-17) is displayed.

**Figure A-16** Searching File Display



e4991aoj195

**Figure A-17** System Recovery Start Screen



e4991aoj146

**Step 5.** Press  Y before starting system recovery.

**A:** \> is indicated on the screen when system recovery is complete.

**Step 6.** Remove the system recovery disk from the floppy disk drive.

**Step 7.** Shut down the E4991A by pressing the Standby switch.

**Step 8.** The E4991A will restart in the system-recovery-complete condition.

Manual Changes  
**Manual Changes**

---

**NOTE**

System recovery can be suspended without execution by pressing N instead of Y in Step 5. **A: \ >** is also indicated on the screen after this selection is made. Remove the system recovery disk and shut down the E4991A by pressing the Standby switch.

---

---

## **B**      **Probe Station Connection Kit (Option 010)**

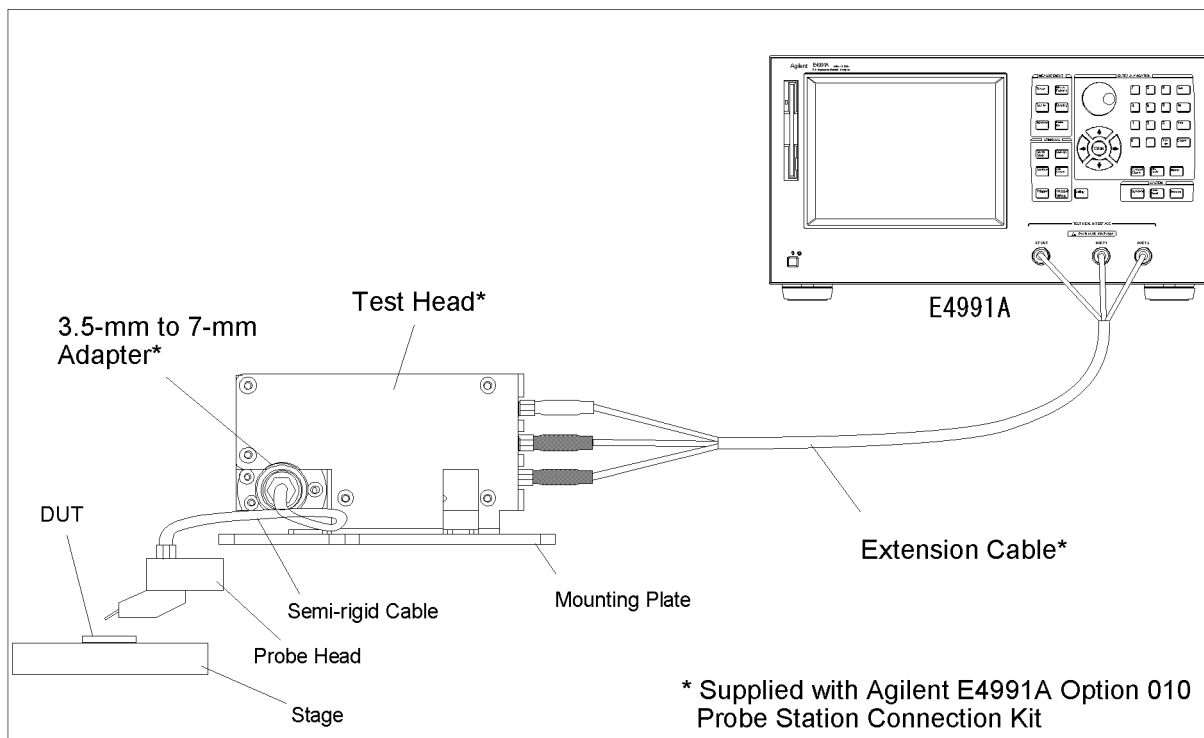
This appendix explains the E4991A Option 010 Probe Station Connection Kit, which is used to connect the instrument to a probe station made by a third-party manufacturer.

## Option 010 Overview

The E4991A Option 010 Probe Station Connection Kit permits connection of the E4991A to any manufacturer's probe station. Agilent Technologies recommends that you use the Cascade Microtech Summit 9000, 11000, and 12000 series probe stations. This connection kit consists of a test head and an extension cable. Mount the test head on the probe station with the parts provided by Cascade Microtech before performing measurement.

Use a probe station to measure the impedance of DUTs such as semiconductor devices, components on a substrate, print patterns, and IC packages.

Figure B-1 Overview



e4991a0e213

### NOTE



You must not apply either alternate or direct current to the DUT port. Doing this could cause operational failure. Pay particular attention to whether the capacitor is charged. Fully discharge the device under test before connecting it to the test head DUT port or test fixture.

### CAUTION

*Whenever you connect a DUT to or disconnect it from the DUT port for measurement, you must first turn off the dc bias or set the sweep to the hold state (in sweep hold state, dc bias is not applied to the DUT). If this step is not taken, the dc bias may destroy the DUT.*



## Recommended Probe Stations

The following probe stations are recommended for use with the Option 010 Probe Station Connection Kit.

- Cascade Microtech Summit 9000 series
- Cascade Microtech Summit 11000 series
- Cascade Microtech Summit 12000 series

## Recommended Probe Heads

The following probe heads are recommended for use with the Option 010 Probe Station Connection Kit.

Cascade Microtech ACP series

- ACP40-GS series
- ACP40-SG series
- ACP40-GSG series

Cascade Microtech HPC series

- HPC40-GSG series

---

### NOTE

Except for the oscillator level, the E4991A standard specifications and supplemental information are applied while using the Option 010 Probe Station Connection Kit. For specifications of the oscillator level, refer to “Oscillator Level” on page 239.

---

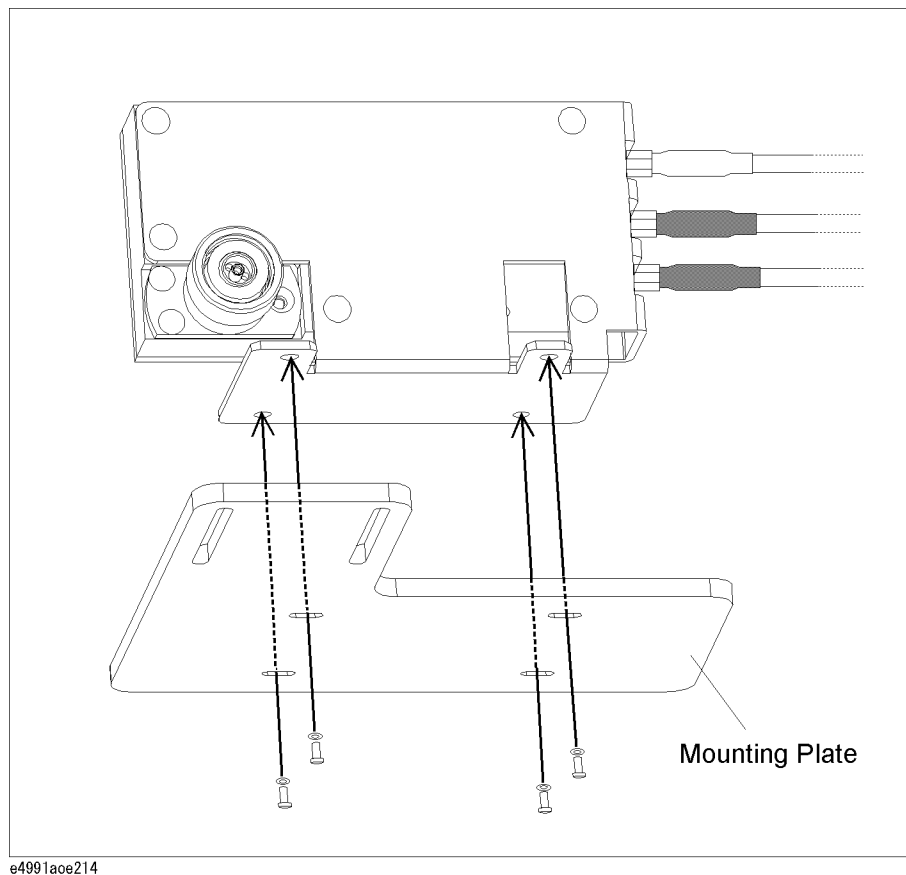
## **Mounting Test Head and Connecting Cables (using recommended probe station)**

To mount the test head, you need the mounting plate and the semi-rigid cable provided by Cascade Microtech in addition to Option 010. The mounting plate is used to connect the test head to the probe arm. The semi-rigid cable is used to connect the test head to the probe head. There are two types of semi-rigid cables: one for the Summit 9000 series and another for the Summit 11000/12000 series. Select the appropriate type for your probe station. To order these parts, please inquire to Cascade Microtech.

**Step 1.** Fix the test head to the mounting plate supplied by Cascade Microtech.

**Figure B-2**

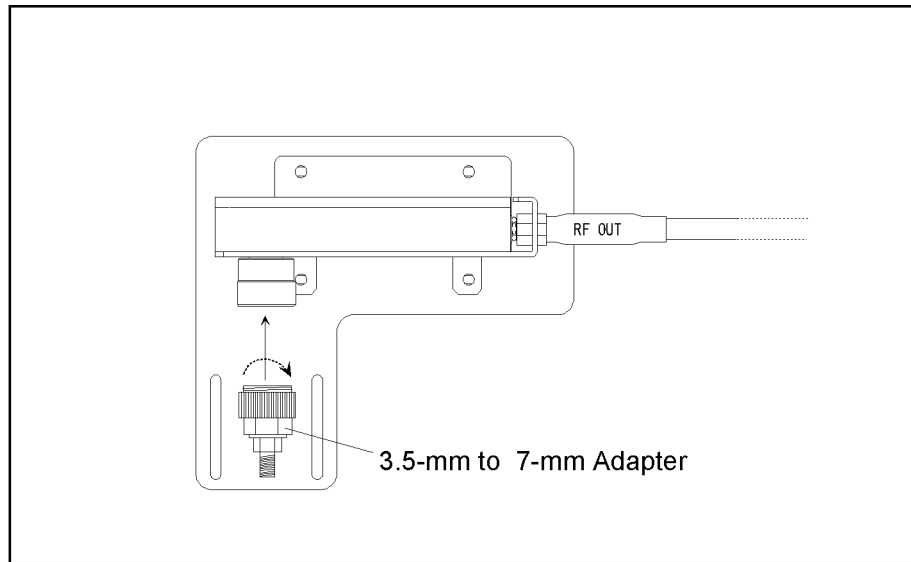
**Fixing Test Head to Mounting Plate**



**Step 2.** Connect the 3.5-mm to 7-mm adapter to the test head's 7-mm connector.

**Mounting Test Head and Connecting Cables (using recommended probe station)**

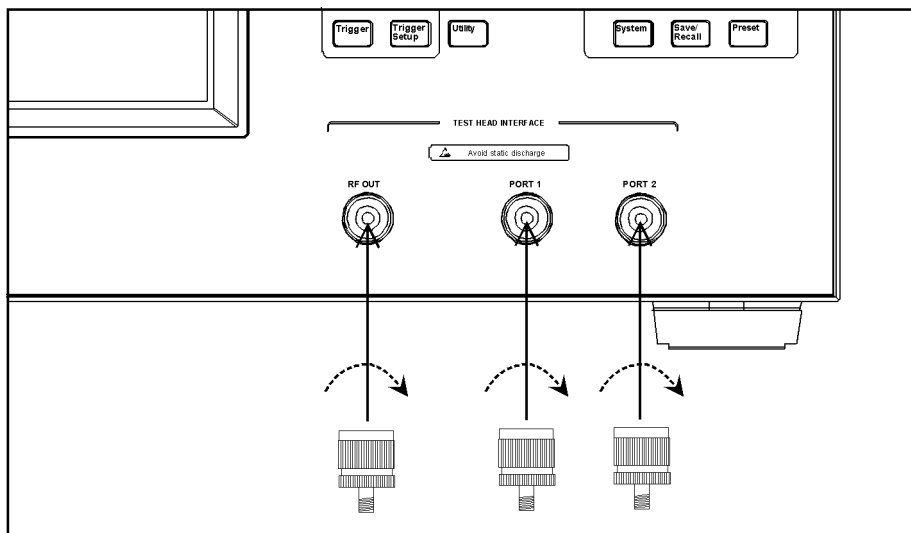
**Figure B-3** Connecting 3.5-mm to 7-mm Adapter



E4991a0e215

- Step 3.** Mount the mounting plate with the test head to the probe arm. For more on how to mount the plate, refer to Cascade Microtech's manual.
- Step 4.** Connect the test head's 3.5-mm connector to the probe head with the semi-rigid cable supplied by Cascade Microtech. For more on how to make this connection, refer to Cascade Microtech's manual.
- Step 5.** Connect each N(m) to SMA(f) adapter to the corresponding port on the E4991A test head interface (RF OUT, PORT1, PORT2).

**Figure B-4** Connecting N(m) to SMA(f) Adapter



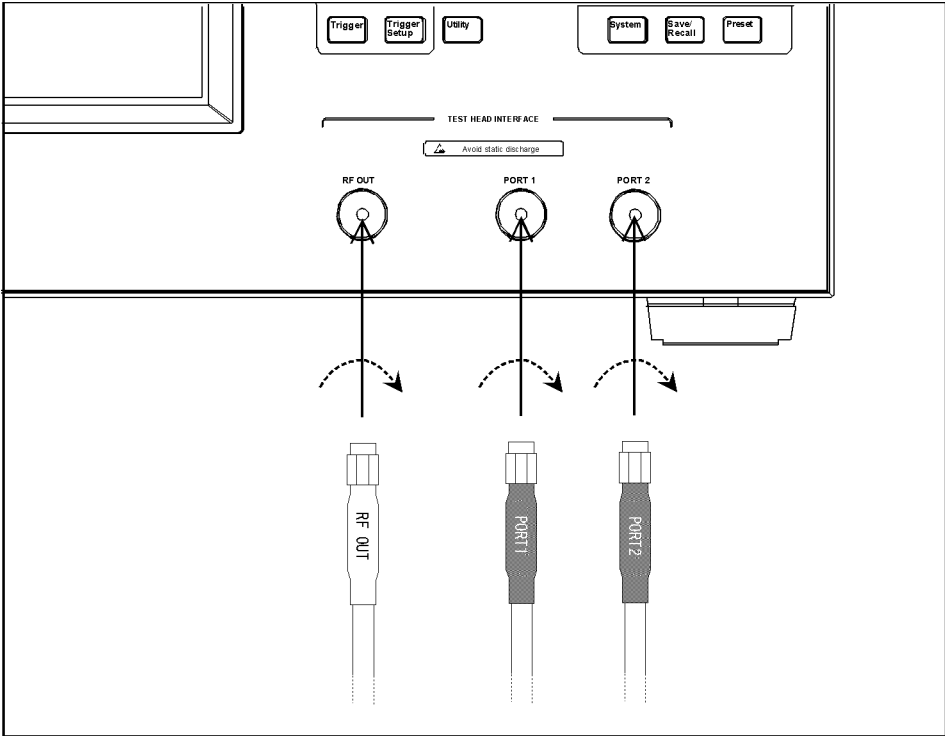
E4991a0e216

- Step 6.** Connect each of the extension cable's SMA(m) connectors to the corresponding port on the E4991A test head interface (RF OUT, PORT1, PORT2). Use a wrench to tighten the

Probe Station Connection Kit (Option 010)  
**Mounting Test Head and Connecting Cables (using recommended probe station)**

connector nut of the SMA(m) connector.

**Figure B-5** Connecting extension cable to E4991A



E4991a0e217

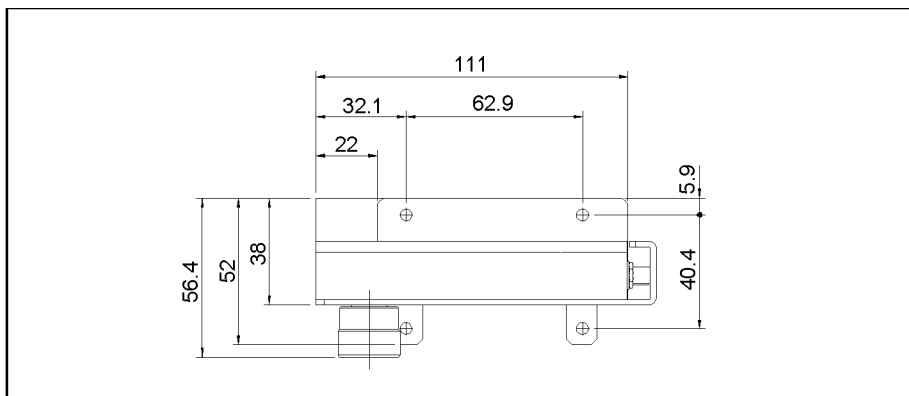
**Mounting Test Head and Connecting Cables (using probe stations other than recommended models)**

**Mounting Test Head and Connecting Cables  
(using probe stations other than recommended models)**

If you use a probe station other than the Cascade Microtech Summit 9000, 11000, or 12000 series, you should prepare a mounting plate that fixes the test head and a cable that connects the test head and probe head. Refer to the test head dimensions (Figure B-6) and customize a mounting plate that connects easily with your probe station. The cable that connects the test head to the probe head should have a 50 Ω characteristic impedance and be as short as possible.

Figure B-6

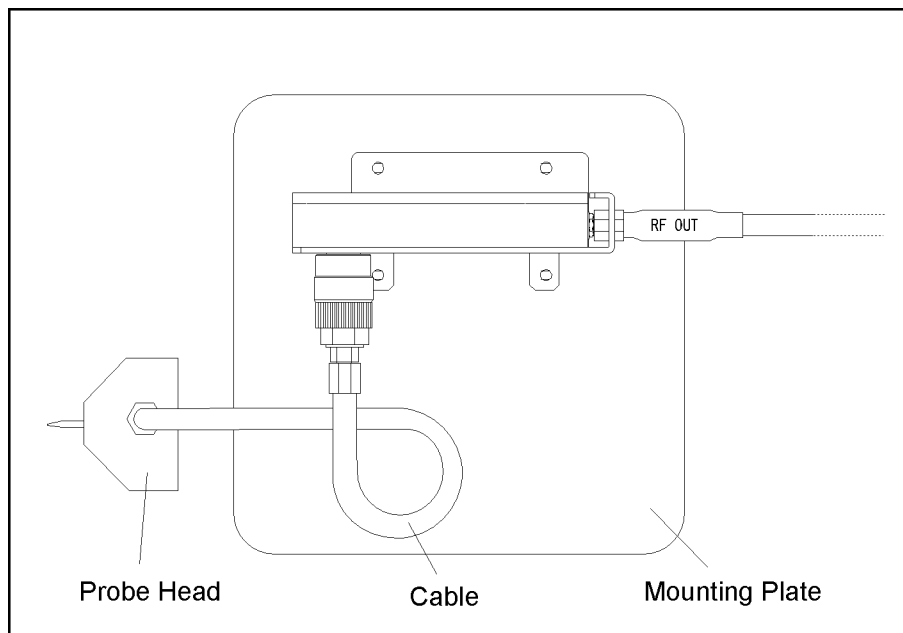
Test Head Dimensions



E4991aoj220

Figure B-7

Example of Mounting Plate and Cable



E4991aoe219

B. Probe Station Connection Kit (Option 010)

## OPEN/SHORT/LOAD Calibration

The OPEN/SHORT/LOAD calibration needs to be performed at the tip of Cascade Microtech's probe head by using the Cascade ISS (Impedance Standard Substrate) to remove residual impedance from the extension cable and probe head.

Set the calibration reference plane to the tip of the probe. Electrical length compensation and fixture compensation (Open compensation and Short compensation) are not executed. Follow the steps below to select fixture type, define calibration kit, select calibration/compensation measurement point mode, and perform OPEN/SHORT/LOAD calibration of the E4991A.

### Selecting Fixture Type

Set the fixture type to **none** to turn off the electrical length compensation in the E4991A.

#### Step 1. Selecting fixture

- a. Right-click to open the shortcut menu and click **Cal/Comp** (or press ).
- b. Click and open the **Fixture Type** box and then click to select **None**.

### Definition of Calibration Kit

The ACP probe head has its own residual parameters such as capacitance (C-Open) at OPEN calibration, inductance (L-Short) at SHORT calibration, and inductance (L-Term) at LOAD calibration. These parameters are defined at each probe pitch and printed inside the probe head's case cover provided by Cascade Microtech. Set the appropriate values in the Cal Kit Menu of the E4991A, depending on the probe head you are using and its pitch.

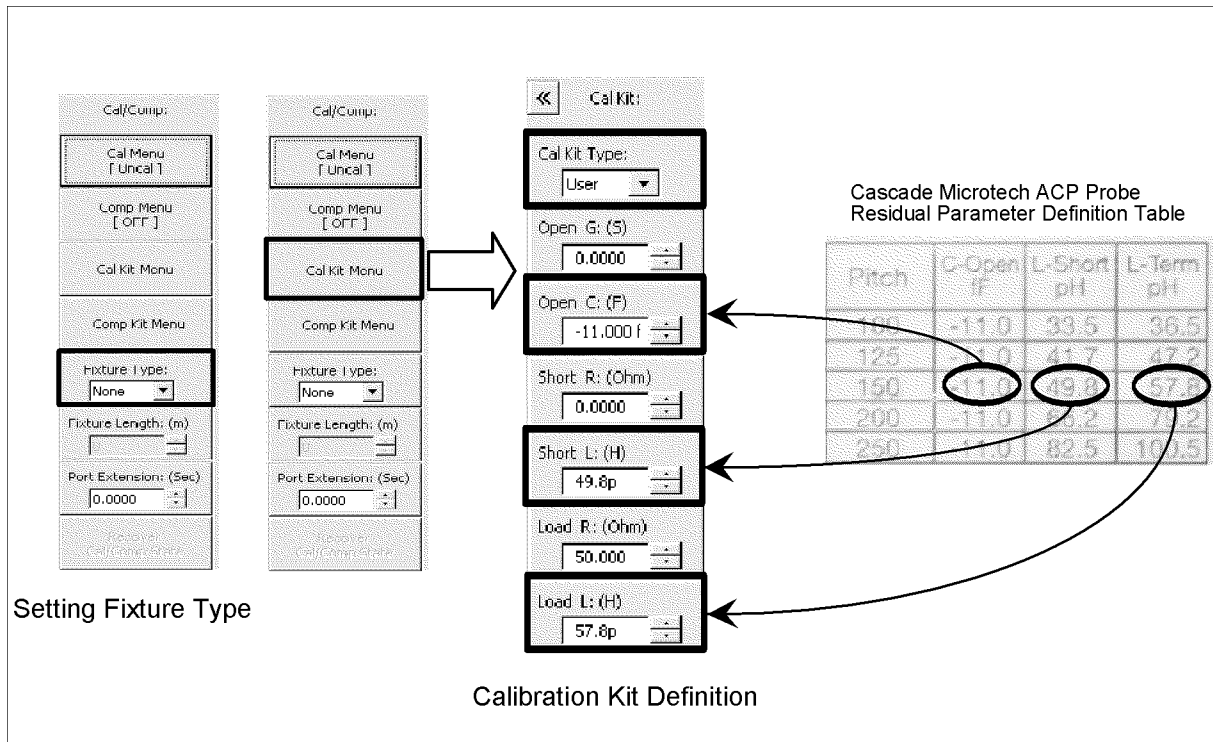
**Step 1.** Click the **Cal Kit Menu** button

**Step 2.** Click and open the **Cal Kit Type** box and click to select **User**.

**Step 3.** Using the numeric entry dialog box that appears by right-clicking inside the calibration kit definition box (or using the **ENTRY/NAVIGATION** block keys on the front panel), enter the definition of the calibration kit:

Calibration Kit Definition Box	Value to be defined
<b>Open C: (F)</b>	Capacitance C at Open Calibration (C-Open)
<b>Short L: (H)</b>	Inductance L at Short Calibration (L-Short)
<b>Load L: (H)</b>	Inductance L at Load Calibration (L-Term)

**Figure B-8 Selection of Fixture Type and Definition of Calibration Kit**



**Calibration/Compensation Measurement Point Mode**

The E4991A has three modes for defining the measurement points when the calibration and compensation data are measured. Agilent Technologies recommends performing calibration in User-defined frequency/User-defined power point mode when using a probe station.

**Table B-1 Calibration/Compensation Measurement Point Mode**

Calibration/Compensation Measurement Point Mode	Calibration/Compensation Measurement Condition			Advantages	Disadvantages
	Frequency	Power	Number of measurement points		
User-defined frequency / User-defined power point mode ( <b>User Freq&amp;Pwr</b> )	Frequency points determined by sweep setups	Power points determined by sweep setups	Same as the number of sweep measurement points (NOP)	The most accurate DUT measurement can be performed	Need to retake the calibration/compensation data if measurement points (frequency and/or power) are changed
Fixed frequency / Fixed power point mode ( <b>Fixed Freq&amp;Pwr</b> )	372 Preset points	372 Preset points	372 × 3 = 1116 points	Not necessary to retake the calibration/compensation data even if the measurement points are changed	Takes more time to complete calibration/compensation data measurement due to large number of measurement points
Fixed frequency / User-defined power point mode ( <b>FixedFreq, UserPwr</b> )	372 Preset points	Power points determined by sweep setups	372 points	Not necessary to retake the calibration/compensation data if the frequency points are changed	

B. Probe Station Connection Kit (Option 010)

### User-defined frequency/User-defined power point mode

This mode obtains calibration/compensation data at the same frequency and power points as those used in actual device measurement, which are determined by the sweep setups. Each set of calibration/compensation data is applied to each measurement at the same points. Accordingly, the most accurate measurement will be performed. If measurement points (frequency and/or power) are changed, calibration should be performed again. User-defined frequency/User-defined power mode is the recommended calibration mode for performing measurement while using a probe station.

### Fixed frequency/fixed power point mode

This mode obtains calibration/compensation data in a fixed frequency and power range of the E4991A. In device measurement, calibration or compensation is applied to each measurement point by using interpolation. This causes interpolation error.

## Calibration of Open/Short/Load

The calibration data of Open/Short/Load is measured according to the following procedure while using the Cascade ISS (Impedance Standard Substrate). For more information on how to use ISS, refer to the Cascade Microtech's manual.

### Step 1. Selection of measurement point for calibration/compensation

- a. Right-click to open the shortcut menu and select **Cal/Comp** (or press **Cal/ Compen**).
- b. Click the **Cal Menu** button.
- c. Click to open the **Cal Type** box and select the desired calibration/compensation measurement point mode. **User Freq&Pwr** (User-defined frequency/User-defined power mode) is recommended for performing calibration.

Cal Type Box	Calibration/Compensation Measurement Point Mode
Fixed Freq&Pwr	Fixed frequency/fixed power point
FixedFreq, UserPwr	Fixed frequency/user-defined power point
User Freq&Pwr	User-defined frequency/user-defined power point

### Step 2. Measurement of open calibration data

- a. Set the probe tip to the open position in the ISS.
- b. Click the **Meas Open** button and measure the open calibration data.

---

#### NOTE

When you want to interrupt measurement of calibration data, click the **Abort Cal Meas** button shown during measurement.

When the measurement of each type of calibration data is finished, a check mark (✓) will appear to the left side of the corresponding calibration execution button. This mark indicates that the calibration data is stored.

---

### Step 3. Measurement of short calibration data.

- a. Set the probe tip to the short position in the ISS.
- b. Click the **Meas Short** button and measure short calibration data.



**Step 4. Measurement of load calibration data.**

- a. Set the probe tip to the load position in the ISS.
- b. Click the **Meas Load** button and measure the load calibration data.

**Step 5. Finishing calibration data measurement and confirmation of calibration state.**

- a. Click the **Done** button to finish measuring the calibration data.

---

**NOTE**

---

To delete all measured calibration data, click the **Cal Reset** button. At the same time, all stored fixture compensation data are also deleted.

- b. Confirm the calibration state according to the display of the **Cal Menu** button as follows.

Display of Cal Menu button	Calibration State
<b>Cal Menu [Fix]</b>	Calibration is on while in the fixed frequency/fixed power point mode
<b>Cal Menu [FixR]</b>	Calibration is on while in the fixed frequency/user-defined power point mode
<b>Cal Menu [User]</b>	Calibration is on while in the user-defined frequency/user-defined power point mode
<b>Cal Menu [Uncal]</b>	Calibration is off

---

**CAUTION**

---

If you change the probe head or the measurement pitch, you should again perform calibration.

Probe Station Connection Kit (Option 010)  
**OPEN/SHORT/LOAD Calibration**

---

**C**

## **Temperature Characteristic Test Kit (Option 007)**

This appendix provides information necessary for measuring temperature characteristic using the thermal characteristic test kit (option 007).

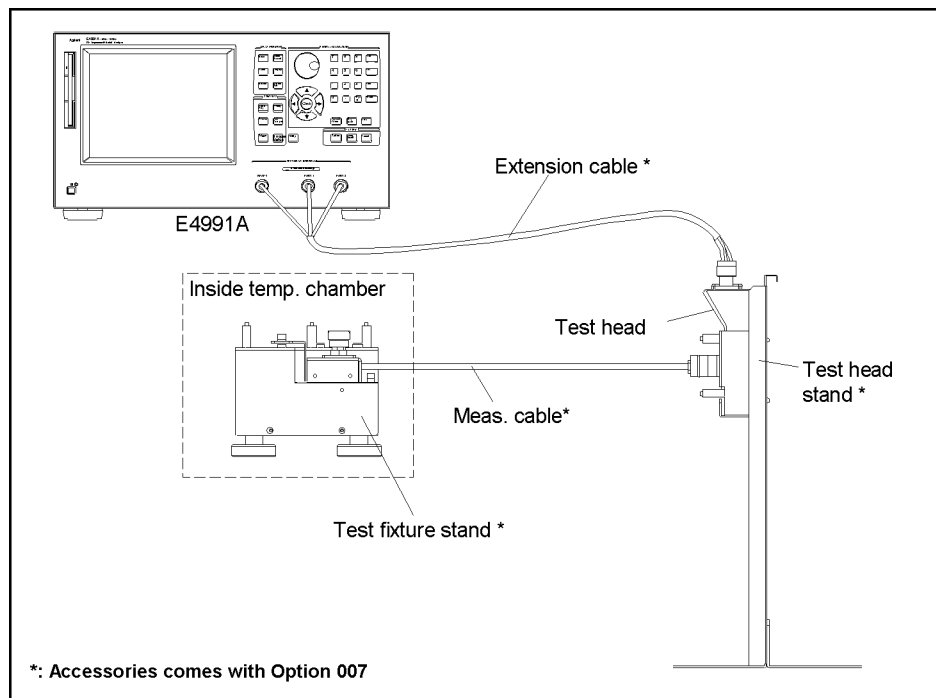
## Overview

The E4991A option 007 temperature characteristic test kit extends the measurement terminal to measure the temperature characteristic of the DUT, and is used along with a temperature chamber<sup>\*1</sup>. This kit makes it possible to perform measurement within the range of -55°C to 150°C by extending the test head as close as possible to the temperature chamber, securing it with a stand, and using the heat-resistant measurement cable to connect the 7-mm terminal of the test head and the fixture stand placed in the temperature chamber, as shown in Figure C-1.

The temperature compensation feature using the built-in VBA macro feature is provided to perform temperature compensation for measurement results, decreasing errors due to temperature changes to acquire more accurate temperature characteristics.

Figure C-1

### Overview of temperature characteristic test kit



e4991a0e853

\*1. To be prepared by the user. The ESPEC SU-261 is recommended, but any other temperature chambers are possibly used.

## Installation

To measure temperature characteristics using the temperature characteristic test kit, connect the devices as shown in Figure C-2.

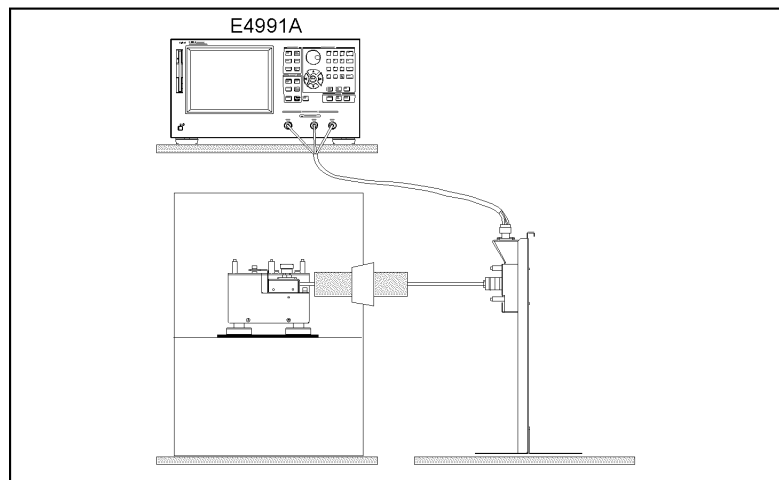
### NOTE

**Wait for at least 1 hour at the highest and lowest temperatures before starting measurement**

In order to obtain stable measurement results, before starting measurement, keep the temperature inside the temperature chamber at the highest temperature of the actual measurement for at least 1 hour and then at the lowest temperature for at least 1 hour. This should be done each time you change the installation.

Figure C-2

Temperature characteristic measurement system



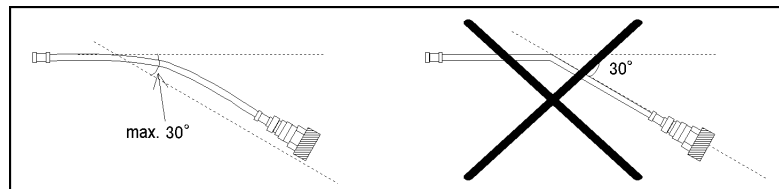
e4991aaj896

### Cautions for protecting cable

- o Use the heat-resistant measurement cable, keeping it straight where possible. If unavoidable, bent it gradually within  $30^\circ$  or less relative to the horizontal as shown in the left figure of Figure C-3.

Figure C-3

Condition for bending measurement cable



e4991ace857

- o Connect the extension cable after all the other settings are completed. After connected, the cable should be carefully handled. In particular, when you connect/disconnect the adapter and the N connector with the cable connected to the adapter or when you forcefully move the connected extension cable, the connector part is stressed and may be damaged.

## Connection procedure

### 1. Mount the test head to the stand.

**Step 1.** Remove the test head from the E4991A.

---

**NOTE**

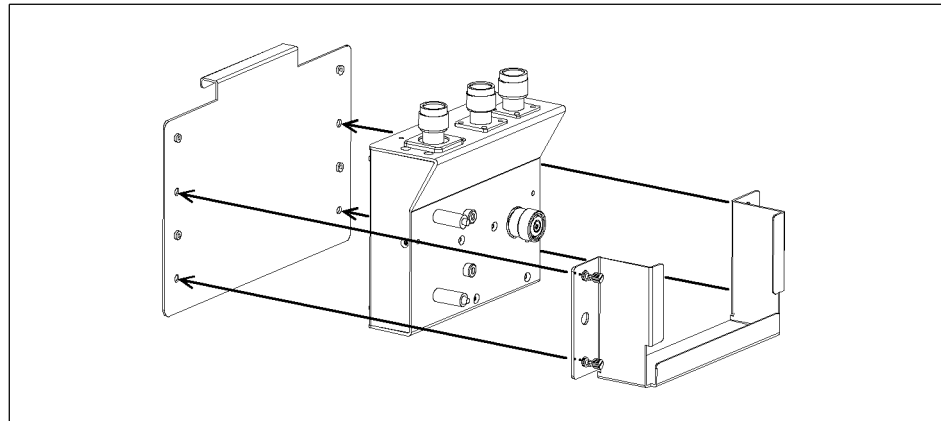
---

First, remove the Type N connector connected to RF OUT. Then, turn both the Type N connectors connected to PORT1 and PORT2 at the same time to remove them.

**Step 2.** Secure the test head you removed to the test head holder.

**Figure C-4**

**Securing test head**

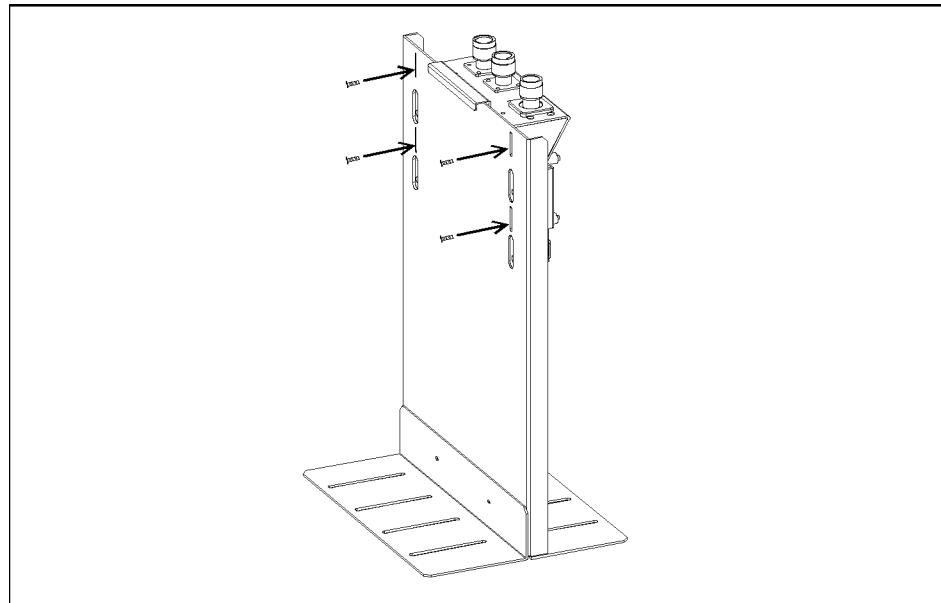


e4991a0j875

**Step 3.** Mount the test head holder to the stand. At this time, do not secure it completely for later fine positioning.

**Figure C-5**

**Mounting test head holder**



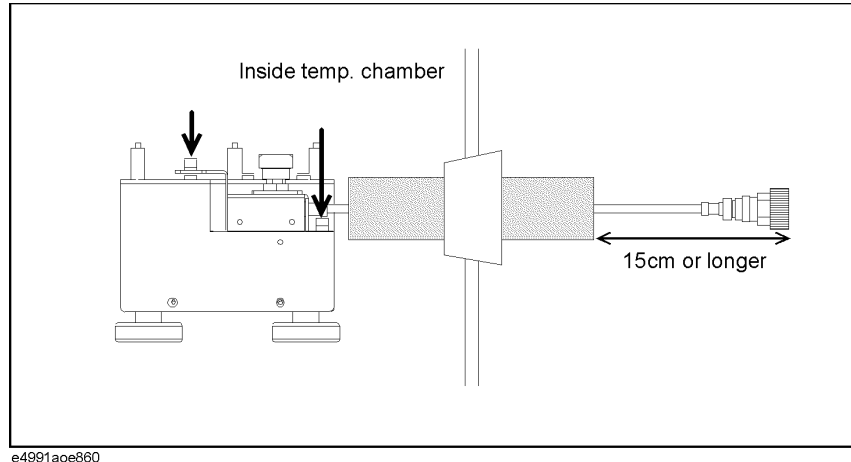
e4991a0j874

**2. Install the measurement cable in the temperature chamber.**

- Step 1.** Insert the measurement cable into the hole in the temperature chamber so that the Type L, 7-mm connector side faces the inside of the temperature chamber. Attach heat insulating materials to the cable as necessary.
- Step 2.** Adjust the position of the test fixture stand so that the length of the part of the measurement cable that is exposed to air outside the temperature chamber (refer to Figure C-6) is 15 cm or longer, and install the measurement cable to the stand.

**Figure C-6**

**Installing measurement cable to test fixture stand**

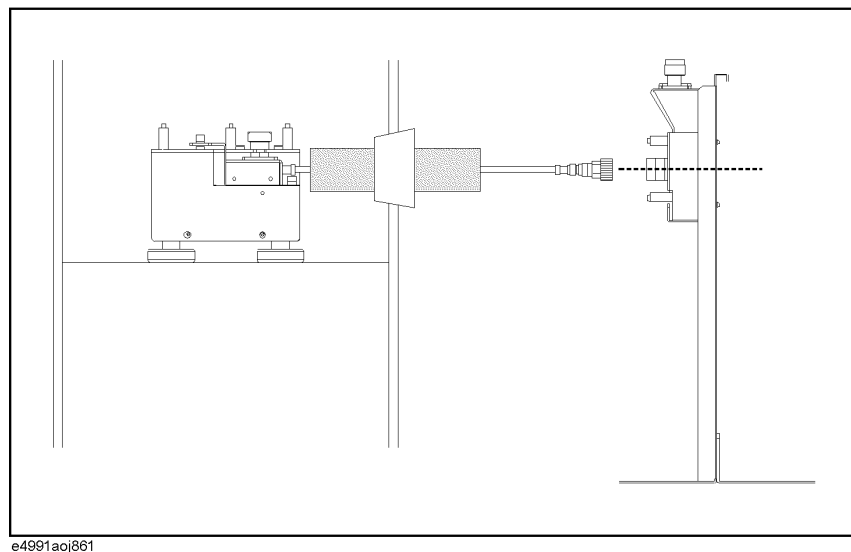


**3. Connect the measurement cable to the test head.**

- Step 1.** Adjust the position of the stand so that the 7-mm connector of the measurement cable and the 7-mm connector of the test head (DUT port) are located at the same height. In this step, fine adjust the position of the test head holder temporarily mounted and secure it tightly.

**Figure C-7**

**Connecting measurement cable and test head**



- Step 2.** Connect the measurement cable and the test head.

C. Temperature Characteristic Test Kit (Option 007)

## Installation

### 4. Connect the extension cable between the E4991A and the test head.

- Step 1.** Connect the N (male) - 3.5 mm (female) adapters to RF Out, Port 1, and Port 2 on the E4991A and then connect the cables to the corresponding ports whose names are written on the extension cable.

---

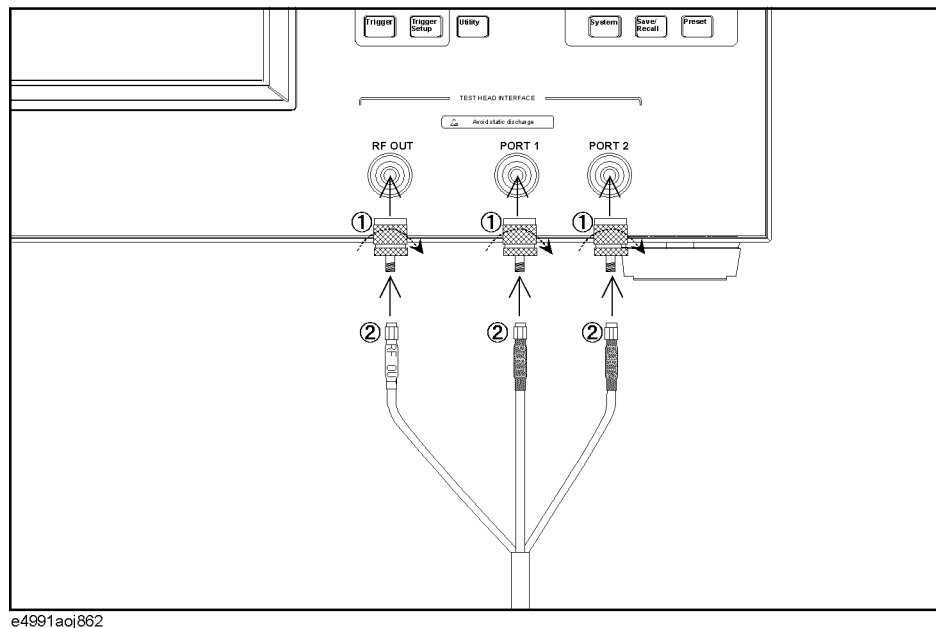
**NOTE**

To avoid damage to the connectors of the extension cable, be sure to connect the adapters to the E4991A first, and then connect the extension cable to the adapters.

---

Figure C-8

Connecting extension cable and E4991A



- Step 2.** Connect the N (female) - 3.5 mm (female) adapters to RF Out, Port 1, and Port 2 on the test head and then connect the cables to the corresponding ports whose names are written on the extension cable.

---

**NOTE**

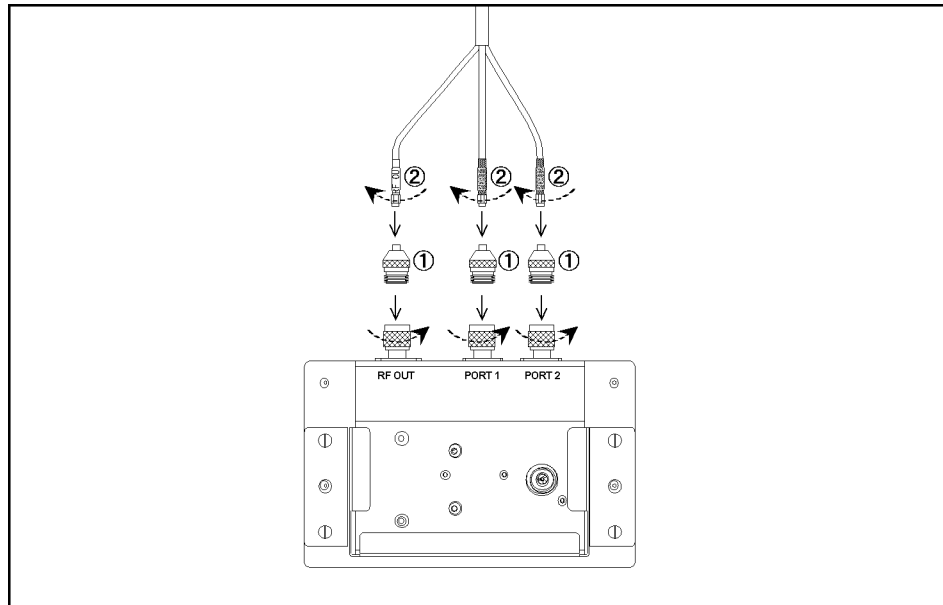
To avoid damage to the connectors of the extension cable, be sure to connect the adapters to the test head first, and then connect the extension cable to the adapters.

---



Figure C-9

Connecting extension cable and test head



e4991aaj863

**Step 3.** To decrease stress on the connector part due to the move of the extension cable, stick the attached mount cable tie (1400-0584) to an appropriate position, and use tie wraps or strings to tie the extension cable to the seat for securing.

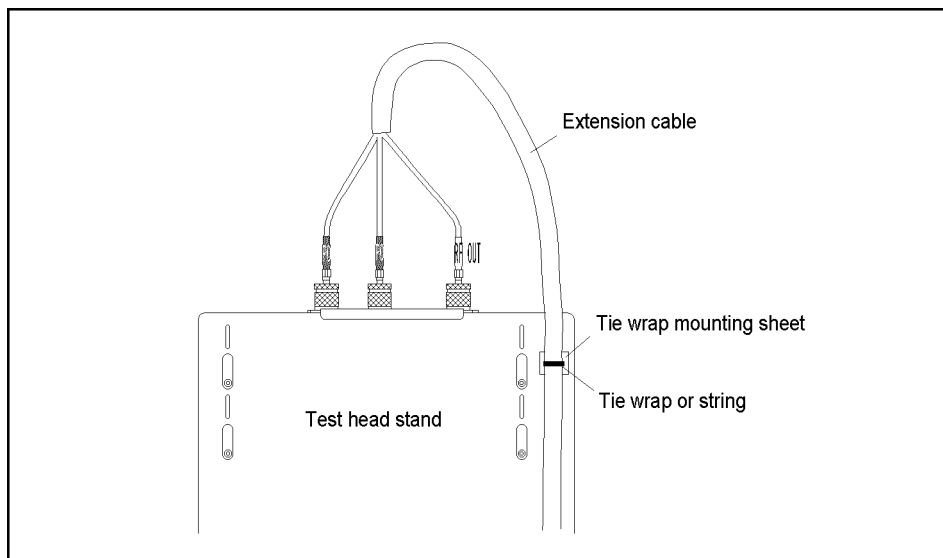
**NOTE**

**When routing the extension cable downward, be sure to secure it at an upper part of the stand.**

When you need to route the extension cable downward (for example, when placing the E4991A by the test head stand), the weight of the cable itself may stress the connector part. To decrease this overload, secure the extension cable at an upper part of the stand as shown in Figure C-10.

Figure C-10

Securing extension cable



e4991aoc867

## Calibration/compensation

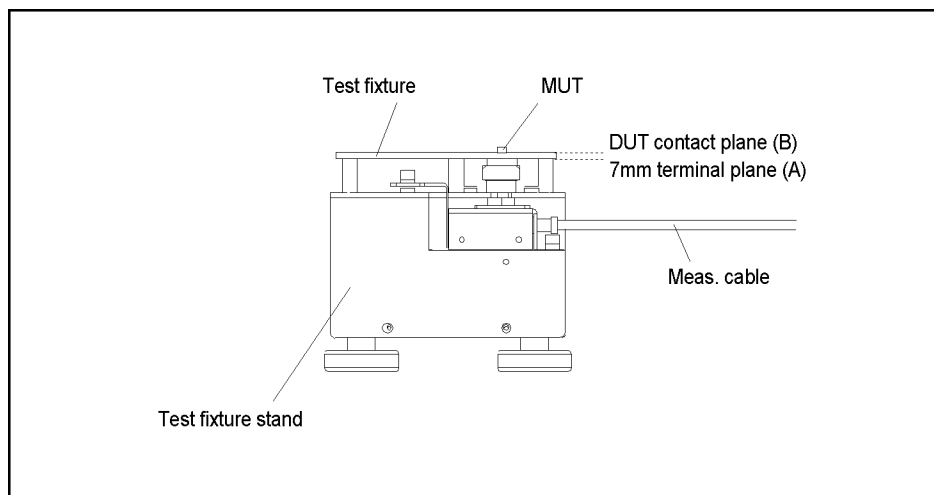
The measurement set with the temperature characteristic test kit connected requires the same calibration/compensation procedures as with usual connection in which the test head is connected directly to the E4991A, except for the calibration reference surface. Perform calibration at room temperature.

While the calibration reference surface is the 7-mm terminal of the test head or the test fixture connected to the 7-mm terminal for the E4991A with the test head is directly connected, it is the 7-mm terminal of the tip of the heat-resistant measurement cable (A in Figure C-11) or the DUT connection terminal of the test fixture connected to the tip of the measurement cable (B in Figure C-11) for the one with the temperature characteristic test kit connected.

For more information about calibration/compensation, see Chapter 4, “Calibration and Compensation.”

Figure C-11

### Calibration reference surface



e4991aoe864

---

## Temperature compensation

Executing the temperature compensation feature will reduce an error due to temperature change. The temperature compensation feature uses reference data to compensate an error that may be related to the measuring cable exposed to temperature change. Prior to compensation, the reference data is prepared by obtaining variation of measurement values of the open/short standards (heat-resistant) relative to normal temperature. The data will be obtained for all temperatures to be measured.

The temperature compensation is executed using a built-in VBA program called TemperatureCompensation.

---

### NOTE

You cannot execute the temperature compensation using the front panel.

You can perform temperature compensation more easily using the attached sample program (tctest) that performs temperature compensation. In particular, when you use ESPEC SU-261 as a temperature chamber, you can use the attached sample program without any modification. For more information, refer to “Measuring temperature characteristic using sample program” on page 351.

### Execution procedure of temperature compensation

Follow the temperature compensation flow shown below.

- Step 1.** Acquire temperature compensation data for the temperature you want to measure and save it in a file. For more information, refer to “Acquiring temperature compensation data” on page 344.
- Step 2.** Execute measurement at a desired temperature.
- Step 3.** Stop the sweep.
- Step 4.** Execute the temperature compensation with the measurement result using the program for compensation. Refer to “Information to create program to execute temperature compensation” on page 341 to create a program to execute temperature compensation using Temperature Compensation.

### Information to create program to execute temperature compensation

#### Preparation for using TemperatureCompensation

TemperatureCompensation is included in the library called Agilent E4991A-007 Compensation Library (DLL). In order to use the Agilent E4991A-007 Compensation Library, you need to enable the reference to it.

#### Enable the reference to Agilent E4991A-007 Compensation Library

- Step 1.** Run the VBA editor.
- Step 2.** On the **Tools** menu of the VBA editor, click **References...** to display the **References** window.
- Step 3.** Check the box associated with Agilent E4991A-007 Compensation Library.

Temperature Characteristic Test Kit (Option 007)  
Temperature compensation

**Function reference**

TemperatureCompensation *temperature, file\_name*

**Description** Reads data from the E4991A, executes compensation at the specified temperature for the data, and then writes the result in the raw data arrays.

**NOTE** This function is provided for the built-in VBA and is not available for HTBasic.

**NOTE** You need to store compensation data files in the following folder.  
D:\Tctest\Compen\

**Variable**

	<i>temperature</i>
Description	Compensation temperature
Data type	Variant type (Variant)
Unit	°C
Resolution	0.1
Note	The compensation temperature must be specified within the following range. -55°C to 150°C

	<i>file_name</i>
Description	Compensation data file name
Data type	Character string type (String)
Note	If the specified file does not exist, an error occurs.

**Example of use**

```
Dim objComp As TemperatureCompensation
Set objComp = New TemperatureCompensation
objComp.TemperatureCompensation 45, "CompFileName"
```

### Sample program

Example C-1 shows a sample program that demonstrates how to execute temperature compensation. You can find the source file of this program, named TempComp.bas, on the sample program disk.

When executed, this program stops the sweep and then executes compensation at 100°C for the measurement result using the compensation data file named "CompData.cpn."

The program is detailed below: Line numbers are added for description purpose only, and do not appear in the actual program source code.

Lines 50 to 60      Assigns TemperatureCompensation to an object type variable, objComp, in order to use the TemperatureCompensation function included in the class module.

Line 110            Stops sweeping on the E4991A.

Line 130            Uses the TemperatureCompensation function to update the displayed data to the data for which temperature compensation has been done.

### Example C-1

#### Execution of temperature compensation (object name: TempComp.bas)

```
10| Sub TempComp()  
20|   Dim Temp As Variant  
30|   Dim CompFile As String  
40|  
50|   Dim objComp As TemperatureCompensation  
60|   Set objComp = New TemperatureCompensation  
70|  
80|   Temp = 100  
90|   CompFile = "CompData.cpn"  
100|  
110|   SCPI.Output ":INIT:CONT OFF"  
120|  
130|   objComp.TemperatureCompensation Temp, CompFile  
140|  
150| End Sub
```

## Acquiring temperature compensation data

You need to acquire temperature compensation data for all temperature points at which you want to make measurement. The temperature compensation data is the difference at each temperature between admittance measurement data for the open standard/impedance measurement data for the short standard and the reference data (measurement data for the open/short standard measured within the temperature range of 18°C to 28°C).

### Execution procedure of acquiring temperature compensation data

---

**NOTE**

When the DC bias feature (option) is provided, turn the feature off while acquiring temperature compensation data.

- 
- Step 1.** Make sure that the temperature of the E4991A itself and tip of the measurement cable is within 18°C to 28°C and execute the open/short/load calibrations at the tip of the measurement cable (7-mm port) in the fixed frequency and fixed power point mode.

---

**NOTE**

Do not change the wiring layout of the measurement cable after executing calibration.

- Step 2.** Set measurement frequency points so that those will form the same sequence as the frequency points used for calibration (the frequency point in the fixed frequency and fixed power point mode).

- Step 3.** Measure the open standard.

1. Connect the heat-resistant open standard to the tip of the measurement cable.
2. Measure the admittance and read out the result. This data is the reference data for open.
3. After putting the temperature chamber (the tip of the measurement cable) to the temperature at which you want to acquire temperature compensation data, wait for at least 30 minutes (until the temperature becomes sufficiently stable) after the temperature is reached.
4. Measure the admittance and read out the result.
5. For each measurement temperature, repeat 3 and 4.

- Step 4.** Measure the short standard.

1. After putting the temperature chamber (the tip of the measurement cable) within 18°C to 28°C, wait for at least 30 minutes (until the temperature becomes sufficiently stable) after the temperature is reached.
2. Connect the heat-resistant short standard to the tip of the measurement cable.
3. Measure the impedance and read out the result. This data is the reference data for short.
4. After putting the temperature chamber (the tip of the measurement cable) to the temperature at which you want to acquire temperature compensation data, wait for at least 30 minutes (until the temperature becomes sufficiently stable) after the temperature is reached.
5. Measure the impedance and read out the result.

6. For each measurement temperature, repeat 4 and 5.

**Step 5.** Calculate open/short data and save it into a file in the following folder.

D:\Tctest\Compen\

#### Open data

From the admittance measurement data for the open standard ( $Y$ ) and the reference data ( $Y_{ref}$ ), calculate the deviation ( $Y - Y_{ref}$ ) and then convert it to the impedance value ( $\frac{1}{Y - Y_{ref}}$ ). The result is the open data.

#### Short data

From the impedance measurement data for the short standard ( $Z$ ) and the reference data ( $Z_{ref}$ ), calculate the deviation ( $Z - Z_{ref}$ ). The result is the short data.

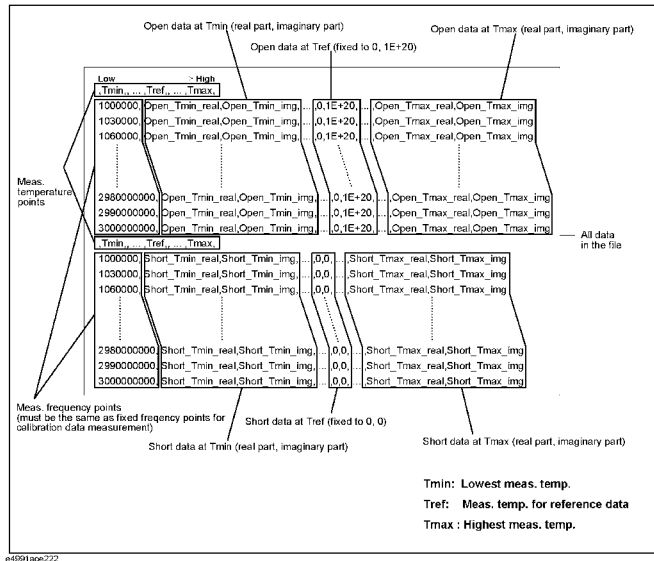
#### Saving compensation data into a file

When saving the temperature compensation data into a file, note the following and follow the example shown in Figure C-12.

- o Separate each data item with a comma (.). No space is needed.
- o You need to write measurement temperature points at the beginning of open data or short data. Arrange them from the lowest temperature to the highest temperature, instead of in the order of measurement execution. For readability when reading data in a compensation data file with a spread sheet program or other applications, you need to pad commas in addition to the ones that separate data items. For example, when you measure the reference data at 23°C and compensation data at 0°C, 10°C, 40°C, and 100°C, the data is ",0,,10,,23,,40,,100,".
- o In each line, write a frequency point at the beginning and then the real part and imaginary part of data at each temperature point from the lowest temperature to the highest.
- o For the data at the temperature at which you measured the reference data, place 0 in the real part of the open data, 1E+20 in the imaginary part, and 0 for both in the real and imaginary parts of the short data. This should be done similarly for all frequency points.

Figure C-12

Format of compensation data file



Sample program

Example C-1 shows a sample program that demonstrates how to acquire temperature compensation data. You can find the source file of this program, named CompMeas.bas, on the sample program disk.

This program measures the heat-resistant open/short standards at 23°C (used for the reference data), 0°C, and 100°C, calculates temperature compensation data, and save it into a file named "CompData.cpn."

NOTE

This sample program is created assuming that it is executed after executing the open/short/load calibrations in the fixed frequency and fixed power point mode.

When executed, this program sets the measurement frequency points so that those make the same frequency point sequence used for the calibration in the fixed frequency and fixed power point mode. Then it displays a message "Set the temperature of the chamber to 23 deg. Then, wait 30 min." After at least 30 minutes elapsed after the temperature of the chamber reaches 23°C, click the **OK** button. When "Connect the Open (heat-resistant) to the Test Port." is displayed, connect the heat-resistant open standard to the tip of the measurement cable and click the **OK** button. The measurement for 23°C is executed. For 0°C and 100°C, perform measurement in the same manner.

When the measurements of the open standard are complete, perform measurements of the short standard in the same manner.

When all the measurements are complete, the temperature compensation data is saved into a file named "D:\Tctest\Compen\CompData.cpn" and then a closing message is displayed.

The program is detailed below. Line numbers are added for description purpose only, and do not appear in the actual program source code.

Line 190 Uses the SetMeasCondition function to set the measurement frequency point so that it forms the same frequency point sequence as used for the calibration in the fixed frequency and fixed power point mode.

Lines 200 to 230 Sets the data formats of trace 4 and trace 5 to admittance and



	impedance respectively and sets both the display formats of trace 4 and trace 5 to the complex plane.
Lines 240 to 270	Sets up the trigger system.
Line 310	Displays a message instructing the user to set the the temperature of the chamber to 23 °C and to wait for 30 minutes.
Line 320	Displays a message that prompts the user to connect the heat-resistant open standard.
Lines 330 to 350	Performs measurement once, reads out the admittance value, and stores it into the MeasDataOpen23 variable.
Line 370	Displays a message instructing the user to set the the temperature of the chamber to 0 °C and to wait for 30 minutes.
Lines 380 to 400	Performs measurement once, reads out the admittance value, and stores it into the MeasDataOpen0 variable.
Line 420	Displays a message instructing the user to set the the temperature of the chamber to 100 °C and to wait for 30 minutes.
Lines 430 to 450	Performs measurement once, reads out the admittance value, and stores it into the MeasDataOpen100 variable.
Lines 470 to 630	Measures data using short standard in the same way as the measurement using open standard and stores it into the MeasDataShor23, MeasDataShor0 and MeasDataShor100 variables.
Line 650	Reads out the number of measurement points.
Lines 660 to 670	Reads out the measurement frequency and stores it into the StimData variable.
Lines 700 to 710	Opens the file.
Line 720	Writes the data of the measurement temperature points.
Lines 730 to 850	Repeats the following steps as many times as the number of points and writes the open data into the file.
Lines 740 to 750	Calculates the real part and imaginary part of the admittance value difference at 0°C relative to the reference data and assigns them to the variables Diff0_r and Diff0_i, respectively.
Lines 760 to 770	Calculates the real part and imaginary part of the admittance value difference at 100°C relative to the reference data and assigns them to the variables Diff100_r and Diff100_i, respectively.
Line 790	Writes the frequency data into the file.
Lines 800 to 810	Converts the admittance difference at 0°C to the impedance value, calculates the real part (= $\text{Diff0\_r}/(\text{Diff0\_r}^2+\text{Diff0\_i}^2)$ ) and imaginary part (= $-\text{Diff0\_i}/(\text{Diff0\_r}^2+\text{Diff0\_i}^2)$ ) of the admittance value, and writes those parts into the file.
Line 820	Writes data (fixed to 0,1E+20,) for the temperature (23°C) at which the reference data was measured.

## Temperature Characteristic Test Kit (Option 007)

### Temperature compensation

- Lines 830 to 840      Converts the admittance difference at 100°C to the impedance value, calculates the real part ( $= \text{Diff100\_r}/(\text{Diff100\_r}^2+\text{Diff100\_i}^2)$ ) and imaginary part ( $= -\text{Diff100\_i}/(\text{Diff100\_r}^2+\text{Diff100\_i}^2)$ ) of the admittance value, and writes those parts into the file.
- Line 860              Writes the data of the measurement temperature points.
- Lines 870 to 950      Repeats the following steps as many times as the number of points and writes the short data into the file.
- Line 890              Writes the frequency data into the file.
- Lines 900 to 910      Calculates the real part and imaginary part of the impedance difference at 0°C and writes those parts into the file.
- Line 920              Writes data (fixed to 0,0,) for the temperature (23°C) at which the reference data was measured.
- Lines 930 to 940      Calculates the real part and imaginary part of the impedance difference at 100°C and writes those parts into the file.
- Lines 960 to 980      Closes the file and displays a closing message.
- Lines 1020 to 1190    The SetMeasCondition function. Sets each segment so that it will form the same frequency point sequence as used for the calibration in the fixed frequency and fixed power point mode and sets the sweep type to segment.

**Example C-2**

**Acquiring temperature compensation data (object name: CompMeas.bas)**

```

10| Sub CompDataMeas()
20|   Dim File As String
30|   Dim MeasDataOpen0 As Variant
40|   Dim MeasDataShor0 As Variant
50|   Dim MeasDataOpen23 As Variant
60|   Dim MeasDataShor23 As Variant
70|   Dim MeasDataOpen100 As Variant
80|   Dim MeasDataShor100 As Variant
90|   Dim StimData As Variant
100|  Dim Diff0_r As Double
110|  Dim Diff0_i As Double
120|  Dim Diff100_r As Double
130|  Dim Diff100_i As Double
140|  Dim Nop As Integer
150|  Dim iFileNo As Integer
160|
170|  File = "CompData.cpn"
180|
190|  Call SetMeasCondition
200|  SCPI.Output ":CALC4:FORM Y"
210|  SCPI.Output ":CALC5:FORM Z"
220|  SCPI.Output ":DISP:TRAC4:GRAT:FORM CPL"
230|  SCPI.Output ":DISP:TRAC5:GRAT:FORM CPL"
240|  SCPI.Output ":TRIG:SOUR BUS"
250|  SCPI.Output ":TRIG:EVEN SWE"
260|  SCPI.Output ":ABOR"
270|  SCPI.Output ":INIT:CONT ON"
280|
290|  ' Open Data Measurement
300|  '   23 deg (Room temperature)
310|  MsgBox "Set the temperature of the chamber to 23 deg. Then, wait
30 min."
320|  MsgBox "Connect the Open (heat-resistant) to the Test Port."
330|  SingleMeasure
340|  SCPI.Output ":CALC4:DATA? FDATA"
350|  SCPI.Enter MeasDataOpen23, "#"
360|  '   0 deg
370|  MsgBox "Set the temperature of the chamber to 0 deg. Then, wait
30 min."
380|  SingleMeasure
390|  SCPI.Output ":CALC4:DATA? FDATA"
400|  SCPI.Enter MeasDataOpen0, "#"
410|  '   100 deg
420|  MsgBox "Set the temperature of the chamber to 100 deg. Then,
wait 30 min."
430|  SingleMeasure
440|  SCPI.Output ":CALC4:DATA? FDATA"
450|  SCPI.Enter MeasDataOpen100, "#"
460|
470|  ' Short Data Measurement
480|  '   23 deg (Room temperature)
490|  MsgBox "Set the temperature of the chamber to 23 deg. Then, wait
30 min."
500|  MsgBox "Connect the Short (heat-resistant) to the Test Port."
510|  SingleMeasure
520|  SCPI.Output ":CALC5:DATA? FDATA"
530|  SCPI.Enter MeasDataShor23, "#"
540|  '   0 deg
550|  MsgBox "Set the temperature of the chamber to 0 deg. Then, wait
30 min."
560|  SingleMeasure
570|  SCPI.Output ":CALC5:DATA? FDATA"
580|  SCPI.Enter MeasDataShor0, "#"
590|  '   100 deg
600|  MsgBox "Set the temperature of the chamber to 100 deg. Then,
wait 30 min."
610|  SingleMeasure
620|  SCPI.Output ":CALC5:DATA? FDATA"
630|  SCPI.Enter MeasDataShor100, "#"

```

## Temperature Characteristic Test Kit (Option 007)

### Temperature compensation

```
640
650 Nop = SCPI.Query(":SWE:POIN?")
660 SCPI.Output ":SWE:STIM1?"
670 SCPI.Enter StimData, "#"
680
690 ' Saving Data
700 iFileNo = FreeFile
710 Open File For Output As iFileNo
720 Print #iFileNo, ",0,,23,,100,"
730 For i = 0 To Nop - 1
740     Diff0_r = MeasDataOpen0(i * 2) - MeasDataOpen23(i * 2)
750     Diff0_i = MeasDataOpen0(i * 2 + 1) - MeasDataOpen23(i * 2 + 1)
760     Diff100_r = MeasDataOpen100(i * 2) - MeasDataOpen23(i * 2)
770     Diff100_i = MeasDataOpen100(i * 2 + 1) - MeasDataOpen23(i * 2
+ 1)
780     Write #iFileNo,
790         Val(StimData(i)),
800         Diff0_r / (Diff0_r * Diff0_r + Diff0_i * Diff0_i),
810         -(Diff0_i / (Diff0_r * Diff0_r + Diff0_i * Diff0_i)),
820         0, 1E+20,
830         Diff100_r / (Diff100_r * Diff100_r + Diff100_i * Diff100_i),
-840         -(Diff100_i / (Diff100_r * Diff100_r + Diff100_i *
Diff100_i))
850     Next i
860     Print #iFileNo, ",0,,23,,100,"
870     For i = 0 To Nop - 1
880         Write #iFileNo,
890             Val(StimData(i)),
900             MeasDataShor0(i * 2) - MeasDataShor23(i * 2),
910             MeasDataShor0(i * 2 + 1) - MeasDataShor23(i * 2 + 1),
920             0, 0,
930             MeasDataShor100(i * 2) - MeasDataShor23(i * 2),
940             MeasDataShor100(i * 2 + 1) - MeasDataShor23(i * 2 + 1)
950     Next i
960     Close iFileNo
970
980     MsgBox "Done. (File Name: " & File & ")"
990
1000 End Sub
1010
1020 Private Sub SetMeasCondition()
1030     SCPI.Output "SEGM:COUN 12"
1040     SCPI.Output "SEGM:POW:STAT ON"
1050     SCPI.Output "SEGM:CURR:OFFS:STAT ON"
1060     SCPI.Output "SEGM1:DATA 1E6,1.24E6,9,8,-13,100e-6,1"
1070     SCPI.Output "SEGM2:DATA 1.26E6,1.5E6,9,8,-13,100e-6,1"
1080     SCPI.Output "SEGM3:DATA 1.55E6,1.95E6,9,8,-13,100e-6,1"
1090     SCPI.Output "SEGM4:DATA 2E6,2.6E6,7,8,-13,100e-6,1"
1100     SCPI.Output "SEGM5:DATA 2.8E6,4E6,7,8,-13,100e-6,1"
1110     SCPI.Output "SEGM6:DATA 4.3E6,4.6E6,2,8,-13,100e-6,1"
1120     SCPI.Output "SEGM7:DATA 5E6,8E6,7,8,-13,100e-6,1"
1130     SCPI.Output "SEGM8:DATA 9E6,16E6,8,8,-13,100e-6,1"
1140     SCPI.Output "SEGM9:DATA 18E6,30E6,7,8,-13,100e-6,1"
1150     SCPI.Output "SEGM10:DATA 33E6,51E6,7,8,-13,100e-6,1"
1160     SCPI.Output "SEGM11:DATA 55E6,95E6,9,8,-13,100e-6,1"
1170     SCPI.Output "SEGM12:DATA 100E6,3E9,291,8,-13,100e-6,1"
1180     SCPI.Output "SWE:TYPE SEGM"
1190 End Sub
```

---

## Measuring temperature characteristic using sample program

---

### NOTE

This sample program is available with the firmware version 3.01 or greater.

The VBA program for temperature characteristic measurement, `tctest.lcr`, is stored in the following folder at the factory.

D:\Tctest

This program includes 2 macros: `Tctest.Start` and `Compensation.Start`.

"`Tctest.Start`" enables you to control the temperature chamber and the E4991A and measure the temperature characteristic of the DUT automatically under 3 different kinds of measurement conditions that are programmed. It also allows you to obtain temperature compensation data to decrease errors due to temperature changes and reflect it to the measurement result of the temperature characteristic, as necessary.

This sample program is created assuming that the recommended temperature chamber (ESPEC SU-261) is used, therefore, when you use ESPEC SU-261, it can be used without any modifications. If you use a temperature chamber other than the ESPEC SU-261, you have to modify the program. For more information, refer to Chapter , "Modifying attached sample program," on page 371.

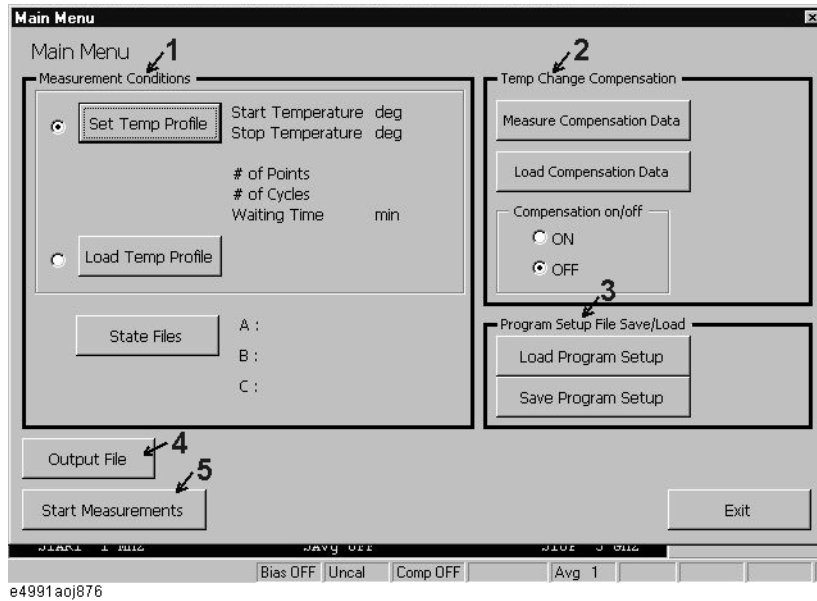
"`Compensation.start`" enables you to perform temperature compensation using temperature compensation data you obtained in advance.

## Measuring temperature characteristic using Tctest.Start macro

### Overview of Tctest.Start

Figure C-13

### Screen displayed immediately after execution of Tctest.Start (Main Menu)



The function of each part is described below.

#### 1. Measurement Conditions

Makes the settings for temperature changes of the temperature chamber. Also, selects a state file (.sta) to be loaded when executing temperature characteristic measurement.

#### 2. Temp Change Compensation

Acquires temperature compensation data and makes the settings for temperature compensation.

#### 3. Program Setup File Save/Load

Saves/recalls the settings for Measurement Conditions and Temp Change Compensation.

#### 4. Output File

Specifies an output file name (a file to save measurement result).

#### 5. Start Measurements

Starts measurement under the conditions you have specified on the Main Menu.

### Preparation for starting measurement

Before starting measurement, check the following items relating to the temperature chamber and the E4991A.

- Checking the temperature chamber  
Using a temperature chamber other than the ESPEC SU-261 will require the program to be modified. For more information, refer to Chapter , “Modifying other temperature chambers than recommended,” on page 372.
- Checking the GPIB address of the temperature chamber  
The GPIB address setting of the temperature chamber when using Tctest.start is "1."  
Using a GPIB address other than "1" will require the program to be modified. For more information, refer to Chapter , “Changing GPIB address,” on page 372.
- Setting the GPIB control mode of the E4991A  
Set the control mode to "System Controller." For more information, refer to “Setting the GPIB” on page 194 in Chapter 9.

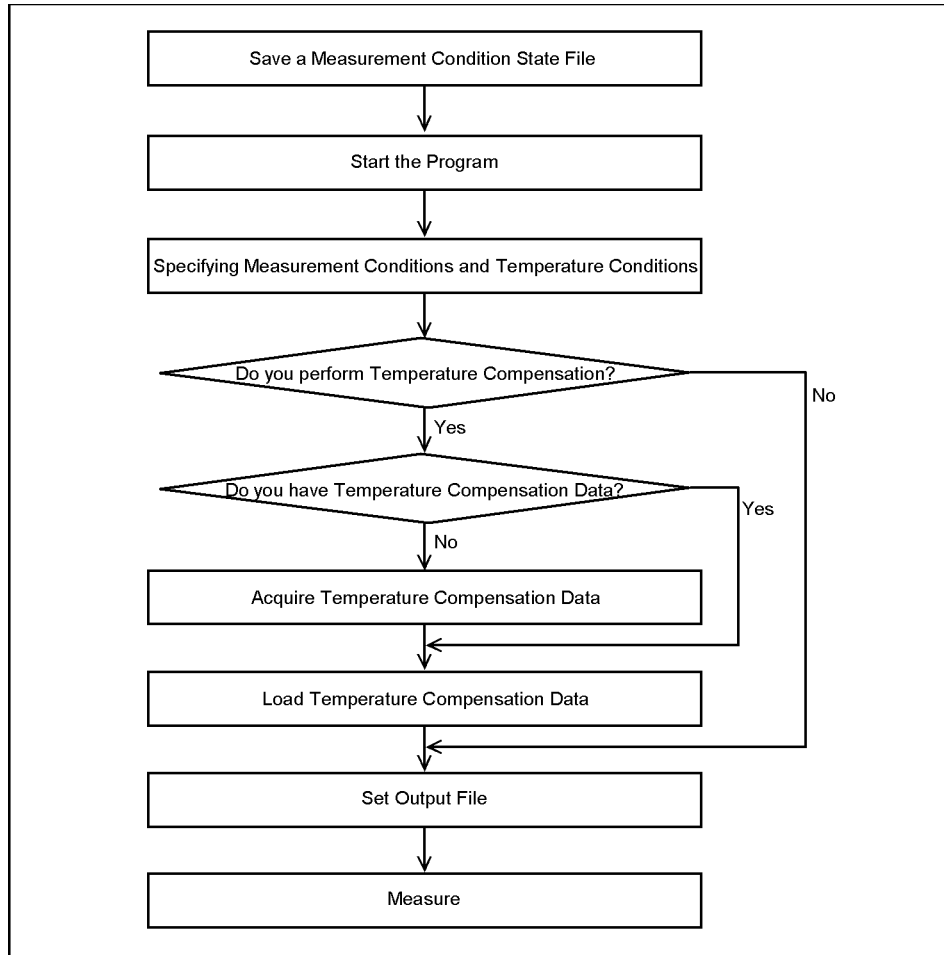
Temperature Characteristic Test Kit (Option 007)  
Measuring temperature characteristic using sample program

Measurement procedure using Tctest.start

The procedure is describe below.

Figure C-14

Flow of measurement using Tctest.start



e4991a0e873



### 1. Saving a measurement condition state file

This sample program allows you to perform measurement under up to 3 different state conditions at each temperature point. At each temperature point, measurement is performed while reproducing measurement conditions by loading the specified state file (.sta). Prior to measurement, therefore, set measurement conditions and save the state file after the execution of calibration/compensation.

---

**NOTE**

Keep the temperature of the temperature chamber constant within the range of 18°C to 28°C while creating a state file.

- Step 1.** Set the measurement conditions of the instrument. For information on the setting method/procedure, refer to Chapter 3, “Setting Measurement Conditions.”
- Step 2.** Execute calibration/compensation. For information on the execution procedure, refer to “Calibration/compensation” on page 340.
- Step 3.** Save the state file (.sta) into the following folder.

D:\TCTEST\STATE

If you want to perform measurement under other conditions, repeat steps 1 through 3.

### 2. Starting the program

Execute the sample program (VBA). For more information on the procedure, refer to Chapter 13, “Use of Macros.” in the Programming Guide.

- Step 1.** Load the sample program, D:\Tctest\tctest.lcr.
- Step 2.** Execute the macro, Tctest.Start.

Temperature Characteristic Test Kit (Option 007)  
**Measuring temperature characteristic using sample program**

**3. Specifying the measurement conditions and temperature conditions**

Set the measurement conditions and temperature conditions on the Main Menu (Figure C-13).

**Step 1.** Setting a temperature profile

You can set one of the following temperature changes (profiles).

- Stepwise temperature change
- Arbitrary temperature change

**NOTE** Choose one of them by using the radio button on the Main Menu (1 in Figure C-13).

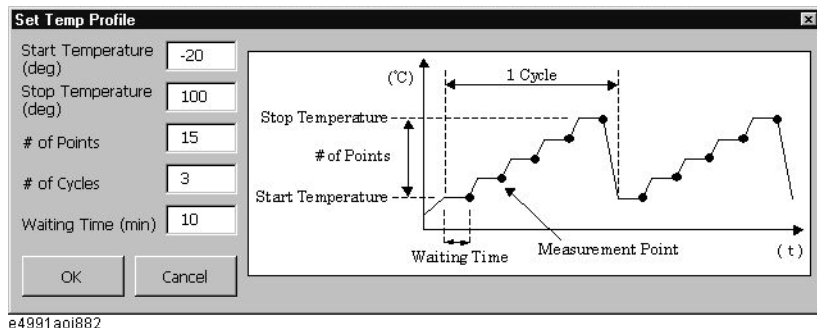
**Stepwise temperature change with constant increment/decrement**

To change temperature stepwise, click **Set Temp Profile** button on the Main Menu and set the following temperature change parameters to specify a temperature change pattern as shown in Figure C-15.

Parameter name	Description
Start Temperature	Temperature of the first measurement point.
Stop Temperature	Temperature of the last measurement point.
# of Points	Number of measurement temperature points.
# of Cycles	Number of temperature change repetitions from Start Temperature to Stop Temperature.
Waiting Time	Waiting time from when each measurement temperature reached as specified to when the measurement is started.

Figure C-15

Set Temp Profile screen (example)



**NOTE** Although Figure C-15 shows a temperature change pattern from the lowest temperature to the highest temperature, you can set the start temperature to the highest temperature and the stop temperature to the lowest temperature.

**Table C-1 Unit, resolution, and limit values of each parameter**

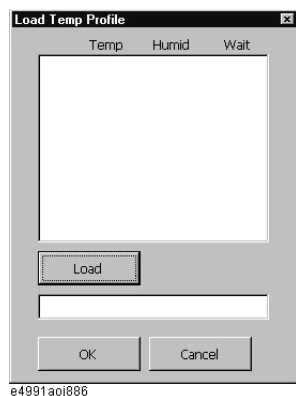
	Unit	Resolution	Maximum value	Minimum value
Start Temperature	°C	0.1	150	-55
Stop Temperature	°C	0.1	150	-55
# of Points	-	1	25	1
# of Cycles	-	1	9	1
Waiting Time	Minute	1	999	1

**NOTE** You can modify the program to change the limit values. For information on how to change them, refer to “Changing limits when setting temperature change pattern” on page 371.

**Arbitrary temperature change**

To change temperature arbitrarily, you have to load a temperature profile file stored in the format shown in "The format of a temperature profile file" in advance. Click the **Load Temp Profile** button on the Main Menu (Figure C-13) to display Figure C-16.

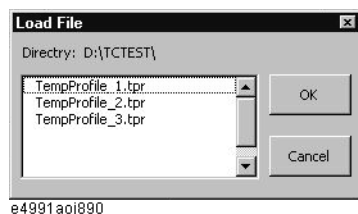
**Figure C-16 Load Temp Profile screen**



Click the **Load** button (Figure C-16) to display Figure C-17. Choose a temperature profile file you want to use for measurement and click the **OK** button.

**NOTE** You can choose from files with the ".TPR" extension located in D:\TCTEST\.

**Figure C-17 Load File screen (example)**



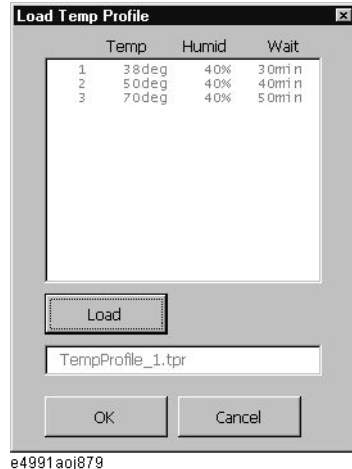
C. Temperature Characteristic Test Kit (Option 007)

Temperature Characteristic Test Kit (Option 007)  
Measuring temperature characteristic using sample program

Click the **OK** button in Figure C-18 to load the temperature profile and return to the Main Menu (Figure C-13).

Figure C-18

Load Temp Profile screen after loading (example)



Format of temperature profile file

To change measurement temperature arbitrarily, you need to create a temperature profile file (measurement temperature state file). You have to save temperature profile files in the following folder.

D:\TCTEST\

The extension should be ".TPR."

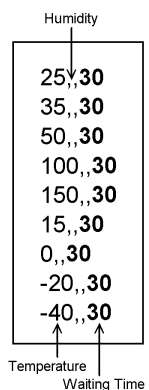
Create files on your external PC. File transfer between the external PC and the E4991A is performed using the FTP server function of the E4991A over LAN. For more information on the FTP server function, refer to Chapter 10, "Using LAN."

In the temperature profile file, each measurement temperature (and humidity) and waiting time after the specified temperature (humidity) reaches as specified are written in the order of:

{temperature},{humidity},{waiting time}

separated with a comma (.). Each temperature point is separated with a line feed.

**Figure C-19** Temperature Profile File (example)



**NOTE** Since the recommended temperature chamber does not provide humidity control, humidity is not specified in Figure C-21.

**NOTE** No space is required between a value and a comma(.).  
 When you do not specify humidity, place no space between commas.  
 Always enter temperatures and waiting times.

**Table C-2** Unit, resolution, and limit values of temperature profile data

	Unit	Resolution	Maximum value	Minimum value
Temperature	°C	0.1	150	-55
Humidity	%	0.1	99	0
Waiting Time	Minute	1	999	1

**NOTE** You can modify the program to change the limit values. For information on how to change them, refer to “Changing limits when setting temperature change pattern” on page 371.

**Step 2.** Setting a state file

Click the **State Files** button on the Main Menu (Figure C-13) to display Figure C-20. Click the **Browse** button, choose a desired state file you saved in advance, and click the **OK** button.

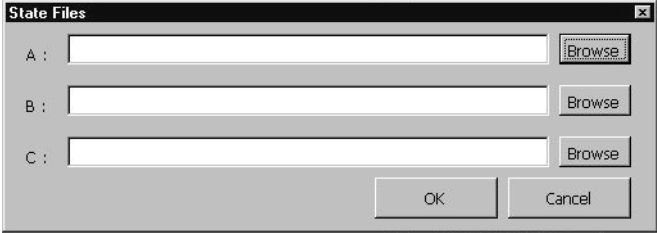
You can specify up to 3 files each for A to C. Specify at least one file.

C. Temperature Characteristic Test Kit (Option 007)

Temperature Characteristic Test Kit (Option 007)  
Measuring temperature characteristic using sample program

Figure C-20

State Files screen



e4991aoj883

#### 4. Acquiring temperature compensation data

When you perform temperature compensation, you need to acquire temperature compensation data according to the following procedure before measuring the DUT.

---

**NOTE** If the DC bias feature (option) is provided, turn it off while acquiring temperature compensation data.

---

**Step 1.** Specify measurement temperature settings using the following temperature profile file. Figure C-21 shows the temperature profile file provided at the factory. You need to acquire temperature compensation data for all measurement temperatures, making any changes as necessary.

D:\TCTEST\CompTemp.Tpr

Edit a file on your external PC. File transfer between the external PC and the E4991A is performed using the FTP server function of the E4991A via LAN. For more information on the FTP server function, refer to Chapter 10, “Using LAN.”.

---

**NOTE** The only valid temperature profile file name when acquiring temperature compensation is D:\TCTEST\CompTemp.Tpr.

---

In the temperature profile file, each temperature (and humidity) at which you want to acquire compensation data and waiting time after the specified temperature (humidity) reached as specified are written in the order of:

{temperature},{humidity},{waiting time}

separated with a comma (.). Each temperature point is separated with a line feed.

Figure C-21

CompTemp.Tpr temperature profile file (factory-set)

```
Humidity
25,,30
35,,30
50,,30
100,,30
150,,30
15,,30
0,,30
-20,,30
-40,,30
Temperature
Waiting Time
```

---

**NOTE** Since the recommended temperature chamber does not provide humidity control, humidity is not specified in Figure C-21.

---

**NOTE** No space is required between a value and a comma(.).

When you do not specify humidity, place no space between commas.

Always enter temperatures and waiting times.

---

Temperature Characteristic Test Kit (Option 007)  
Measuring temperature characteristic using sample program

**Step 2.** Make sure that the temperature of the E4991A and the end of the measurement cable is within 18°C to 28°C and execute the open/short/load calibration at the end of the measurement cable (7-mm port) in the fixed frequency and fixed power point mode.

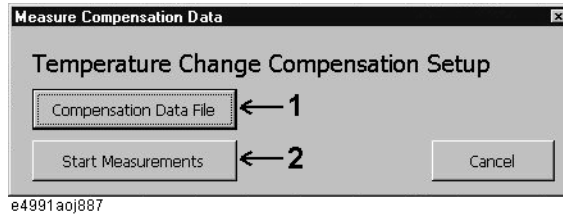
---

**NOTE** Keep the measurement cable in the same position as it was when calibration was performed.

---

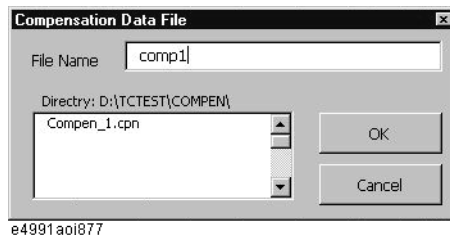
**Step 3.** Click the **Measure Compensation Data** button on the Main Menu (Figure C-13).

**Figure C-22** Temperature Change Compensation Setup screen



**Step 4.** Click the **Compensation Data File** button (1 in Figure C-22). The screen shown in Figure C-23 appears. Enter a compensation data file name and click the **OK** button.

**Figure C-23** Compensation Data File screen when entering a file name (example)



---

**NOTE** The box below Directory: D:\TCTEST\COMPEN\ only displays the list of existing file names. You cannot choose a file from the list. If you enter the same file name as one of the displayed files and click the **OK** button, a message to confirm overwrite is displayed. If you click the **Yes** button, data will be overwritten after the completion of measurement.

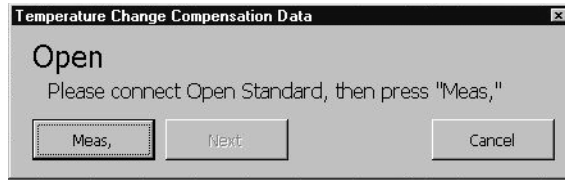
---

**Step 5.** Click the **Start Measurement** button (2 in Figure C-22) to start temperature compensation data measurement.



The screen shown in Figure C-24 appears. Connect the heat-resistant open standard attached to Option 007 and then click the **Meas** button to start the open measurement.

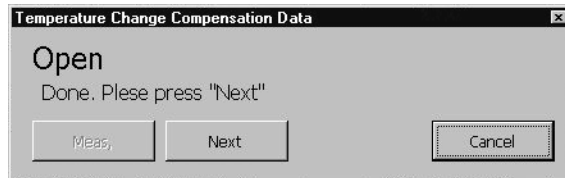
**Figure C-24** Temperature Change Compensation Data screen when measuring open connection



e4991 a0j881

When measurements at all temperature points are completed, the screen shown in Figure C-25 appears. Click the **Next** button.

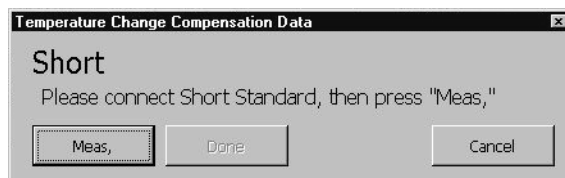
**Figure C-25** Temperature Change Compensation Data screen when open measurement is complete



e4991 a0j866

A screen appears as shown in Figure C-26. Connect the heat-resistant short standard attached to Option 007 and then click the **Meas** button to start the short measurement.

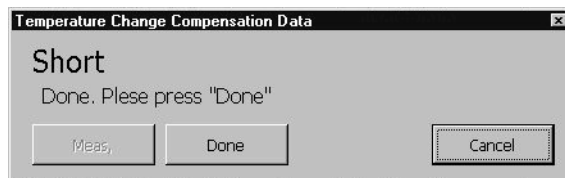
**Figure C-26** Temperature Change Compensation Data screen when measuring the short connection



e4991 a0j869

When measurements at all temperature points are completed, the screen shown in Figure C-27 appears. Click the **Done** button to finish the temperature compensation data measurement and return to the Main Menu.

**Figure C-27** Temperature Change Compensation Data screen when the short measurement is complete



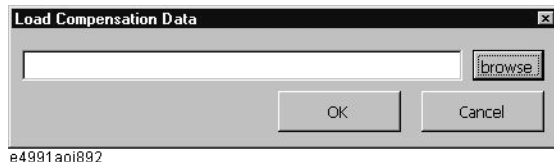
e4991 a0j870

## 5. Loading temperature compensation data

### Specifying temperature compensation data file

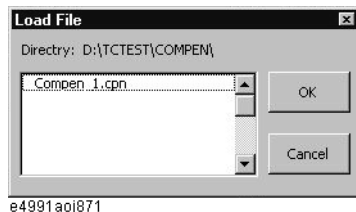
Specify the compensation data you saved in acquiring temperature compensation data. Click the **Load Compensation Data** button on the Main Menu (Figure C-13) to display the screen in Figure C-28. Click the **browse** button.

Figure C-28 Load Compensation Data screen



Select your desired file in Figure C-29 and click the **OK** button.

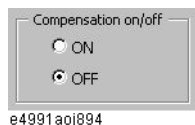
Figure C-29 Temperature Compensation Data Select screen (example)



### Turning on/off the temperature compensation data

You need to turn on/off the compensation with the radio buttons on the Main Menu (Figure C-13).

Figure C-30 Compensation on/off screen



### Measurement Conditions and Temp Change Compensation save/recall feature

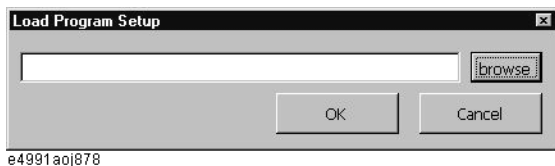
You can also load the setting of Measurement Conditions and Temp Change Compensation that have been stored in a file to reproduce them.

#### Loading procedure

- Step 1.** Click the **Load Program Setup** button on the Main Menu (Figure C-13) to display the screen in Figure C-31. Click the **browse** button.

Figure C-31

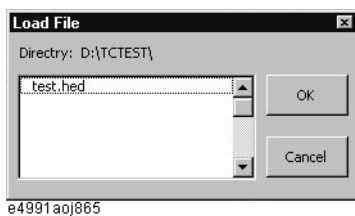
#### Load Program Setup screen



- Step 2.** Select your desired file Figure C-32 and click the **OK** button.

Figure C-32

#### Program Setup Select screen (example)

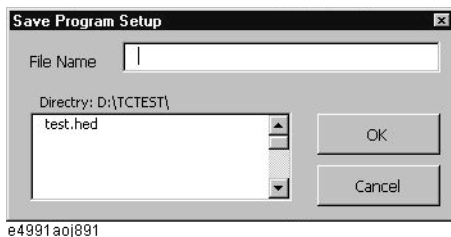


#### Saving procedure

Click the **Save Program Setup** button on the Main Menu (Figure C-13) to display Figure C-33. Enter a file name and click the **OK** button.

Figure C-33

#### Save Program Setup screen (example)



#### NOTE

The box below Directory: D:\TCTEST\ only displays the list of existing file names. You cannot specify a file from the list.

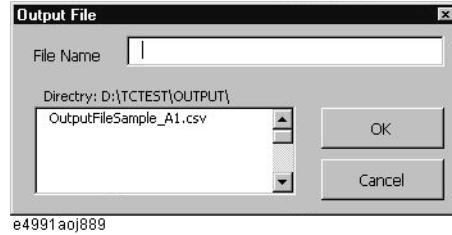
Temperature Characteristic Test Kit (Option 007)  
Measuring temperature characteristic using sample program

6. Setting output file

Click **Output Files** on the Main Menu (Figure C-13) to display Figure C-34. Enter an output file name and click the **OK** button.

Figure C-34

Output File screen (example)



**NOTE**

The box below Directory: D:\TCTEST\OUTPUT\ only displays the list of existing file names. You cannot specify a file from the list. If you enter the same file name as one of the displayed files and click the **OK** button, a message to confirm overwrite is displayed. If you click the **Yes** button, the data is overwritten.

**NOTE**

The storage folder for output files is D:\TCTEST\OUTPUT only.

Measurement results are saved in a file whose name is automatically defined by combining the file name specified above and the character "\_" followed by 2 characters indicating data type:

1st character : Symbol of a state file used for measurement  
(Corresponding to one of A to C when specifying a state file)

2nd character : Trace number

For example, if you specify an output file name as "test," the measurement result of trace 2 under the measurement conditions in state file B is saved under the name "test\_B2.CSV."

Figure C-35 Example of output file (imported in Microsoft Excel)

	A	B	C	D	E
1	DATE	3/1/03			
2	Start Temperature	30			
3	Sopt Temperature	50			
4	# of Points	2			
5	# of Cycles	1			
6	Waiting Time	1			
7	Temperature Profile	TempProfile_1.tpr			
8	State A	s1.sta			
9	State B	s2.sta			
10	State C	s3.sta			
11	Output File Name	TESTOUT			
12	Compensation File	Comp_1.cpn			
13	Time		5	13	
14	Temp		30	50	
15	Humid				
16		1000000	72.45802	48.56442	
17		15995000	46.50713	55.2745	
18		30990000	16.41677	51.16277	
19		45985000	81.71821	11.80772	
20		60980000	114.631	9.78974	
21		75975000	43.79963	42.04801	
22		90970000	25.08076	57.59014	
23		105965000	42.25489	95.1433	
24		120960000	25.49979	30.35562	
25		135955000	48.28891	31.98307	
26		150950000	21.8227	30.11072	
27		165945000	76.11351	99.64045	
28		180940000	29.97921	102.4189	
29		195935000	35.28496	44.46402	
30		210930000	64.34106	21.74946	
31		225925000	12.41398	46.59035	
32		240920000	137.3695	67.00294	
33		255915000	114.4114	33.27658	
34					

1. Date of file saving
2. Measurement conditions and temperature conditions
3. Elapsed time from the measurement start (unit: minute)
4. Measurement temperature point (unit: °C)
5. Measurement humidity point (unit: %)
6. Stimulus data
7. Trace data for each measurement temperature/humidity

Temperature Characteristic Test Kit (Option 007)  
Measuring temperature characteristic using sample program

7. Measurement

When you have entered all the following conditions, you can start measurement.

- Temperature profile condition (1 in Figure C-13)
- State file (1 in Figure C-13)
- Temperature compensation data setting (2 in Figure C-13): when using temperature compensation data
- On/off of using temperature compensation data (2 in Figure C-13)
- Output file (4 in Figure C-13)

**Step 1.** Turn on the main power supply on the upper-right side of the ESPEC SU-261 and press the **POWER** key and the **CONST.OPER./STOP** key on the front panel. For a temperature chamber other than SU-261, set it so that it can accept the temperature setting command.

**Step 2.** Click the **Start Measurements** button on the Main Menu (6 in Figure C-13) to start measurement. Measurement results are save in Output files.

---

**NOTE** The trace saved in the output file depends on the measurement condition in the loaded file. Only scalar traces (traces 1 to 3) displayed with the measurement condition in each loaded state file are saved as the measurement result.

---

---

**NOTE** The Output file is saved in the following directory.  
D:\TCTEST\OUTPUT\

---

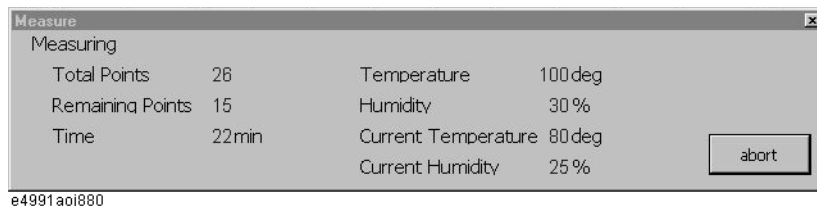
---

**NOTE** When the measurement is complete, the temperature chamber is set to the initial temperature (at the start of measurement).

---

The following screen is displayed during measurement.

**Figure C-36** The Measure screen (example)



## Temperature compensation for measurement result using Compensation.Start macro

You can execute temperature compensation for your manual measurement result using Compensation.Start.

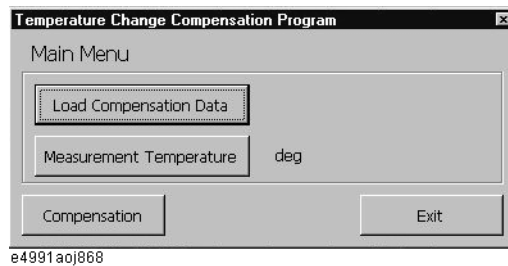
### NOTE

This macro assumes that temperature compensation data was acquired before it is used. For information on measuring/saving temperature compensation data, refer to “Temperature compensation” on page 341 or “4. Acquiring temperature compensation data” on page 361.

### Measurement procedure

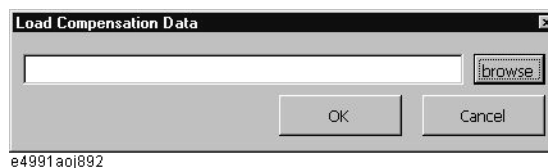
- Step 1. Execute measurement.
- Step 2. Set the trigger setting of the E4991A to HOLD (sweep stop).
- Step 3. Load the temperature characteristic program and execute the Compensation.Start macro.

Figure C-37 Screen displayed immediately after execution of Compensation.Start (Main Menu)



- Step 4. Set the calibration data.
  - a. Click the **Load Compensation Data** button on the Main Menu (Figure C-37) to display the screen in Figure C-38. Click the **browse** button.

Figure C-38 Load Compensation Data screen



Temperature Characteristic Test Kit (Option 007)  
Measuring temperature characteristic using sample program

- b. Select your desired file in Figure C-39 and click the **OK** button.

**Figure C-39** Temperature Compensation Data Select screen (example)



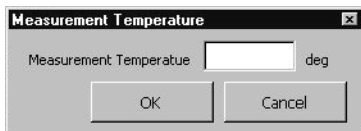
e4991a0j871

**NOTE**

The temperature compensation data at measurement must be included in the temperature compensation data.

- Step 5.** Enter the temperature when executing measurement in Step 2 (the set temperature of the temperature chamber). Click the **Measurement Temperature** button on the Main Menu (Figure C-37) to display Figure C-40. Enter a temperature and click the **OK** button.

**Figure C-40** Measurement Temperature screen



e4991a0j895

- Step 6.** Click the **Compensation** button on the Main Menu (Figure C-37) to display (overwrite) the result after temperature compensation for the data at execution. Inside the E4991A, the raw data array is overwritten with the data. After the execution of compensation, the program terminates automatically.



## Modifying attached sample program

### Changing limits when setting temperature change pattern

The sample program provides the limits (upper limit/lower limit) as Table C-1 on page 357 and Table C-2 on page 359 when setting the temperature change pattern. These values are defined as the following constants in the standard module named UserConstant. You can change the limits by changing the definition of these constants.

**Figure C-41**

#### Definition part of limit values (part of standard module, UserConstant)

```
' limit value of temperature data
Public Const StartTempMax = 150           ' maximum start temperature (deg)
Public Const StartTempMim = -55          ' minimum start temperature (deg)
Public Const StopTempMax = 150           ' maximum stop temperature (deg)
Public Const StopTempMim = -55           ' minimum stop temperature (deg)
Public Const NumOfPointsMax = 25          ' maximum # of points
Public Const NumOfPointsMim = 1           ' minimum # of points
Public Const NumOfCyclesMax = 9           ' maximum # of cycles
Public Const NumOfCyclesMim = 1           ' minimum # of cycles
Public Const WaitingTimeMax = 999         ' maximum waiting time (min)
Public Const WaitingTimeMim = 1           ' minimum waiting time (min)

' limit value of temp profile data
Public Const TemperatureMax = 150         ' maximum temperature (deg)
Public Const TemperatureMim = -55         ' minimum temperature (deg)
Public Const HumidityMax = 99             ' maximum humidity (%)
Public Const HumidityMim = 0              ' minimum humidity (%)
Public Const ProWaitingTimeMax = 999      ' maximum waiting time (min)
Public Const ProWaitingTimeMim = 1        ' minimum waiting time (min)
```

e4991aoj223

The following table shows the relationship between the limits and the constants.

Limit item		Constant name	Unit
Start Temperature in Table C-1	Upper limit	StartTempMax	°C
	Lower limit	StartTempMim	°C
Stop Temperature in Table C-1	Upper limit	StopTempMax	°C
	Lower limit	StopTempMim	°C
# of Points in Table C-1	Upper limit	NumOfPointsMax	—
	Lower limit	NumOfPointsMim	—
# of Cycles in Table C-1	Upper limit	NumOfCyclesMax	—
	Lower limit	NumOfCyclesMim	—
Waiting time in Table C-1	Upper limit	WaitingTimeMax	Minute
	Lower limit	WaitingTimeMim	Minute
Temperature in Table C-2	Upper limit	TemperatureMax	°C
	Lower limit	TemperatureMim	°C
Humidity in Table C-2	Upper limit	HumidityMax	%
	Lower limit	HumidityMim	%
Waiting time in Table C-2	Upper limit	ProWaitingTimeMax	Minute
	Lower limit	ProWaitingTimeMim	Minute

## Changing GPIB address

The GPIB address of the temperature chamber is defined to 1 with the GpibAddress constant, as shown below, in the standard module named ChamberControl. You can change the GPIB address to a value other than 1 by changing the definition of this constant.

Figure C-42

### Definition part of GPIB address (part of standard module, ChamberControl)

```
.....  
' chamber GPIB address  
Private Const GpibAddress = 1  
.....  
e4991aoj224
```

## Modifying other temperature chambers than recommended

When you use a constant temperature (and humidity) chamber other than the recommended one(ESPEC SU-261), change the limits of temperature/humidity when setting the temperature change pattern depending on the chamber you use. For information on how to change them, refer to “Changing limits when setting temperature change pattern” on page 371. In addition, change the part that controls the temperature chamber in the program depending on the chamber you use.

### When using temperature chamber that can control temperature only

If your temperature chamber can control temperature only, change the following functions in the ChamberControl standard module.

- StartOperation  
StartOperation is a function that turns on the temperature chamber. Change the command sending part (1 in Figure C-43) according to the specification of the GPIB command that turns on the temperature chamber you use. If the command has no Query response, delete the receiving part (2 in Figure C-43).
- GetTemp  
GetTemp is a function that checks the temperature of the temperature chamber. Change the command sending part (3 in Figure C-43) according to the specification of the GPIB command that checks the temperature of the temperature chamber you use.
- SetTemp  
SetTemp is a function that sets the temperature of the temperature chamber. Change the command sending part (4 in Figure C-43) according to the specification of the GPIB command that sets the temperature chamber you use. If the command has no Query response, delete the receiving part (5 in Figure C-43).
- CurrentTemp  
CurrentTemp is a function that acquires temperature information from the string obtained as the response to the temperature check command. Change the processing part (6 in Figure C-43) according to the specification of the GPIB command that checks the temperature of the temperature chamber you use.

Figure C-43

Part to be changed when using a temperature chamber that can control temperature only (part of standard module, UserConstant)

```

Public Function StartOperation()
    ' send power on command to the chamber
    lngStatus = viVPrintf(lngDcsp, "POWER,ON"& Chr$(10), 0)
    If (lngStatus <> VI_SUCCESS) Then GoTo VisaErrorHandler

    ' reads the result.
    lngStatus = viVScanf(lngDcsp, "%t", strRes)
    If (lngStatus <> VI_SUCCESS) Then GoTo VisaErrorHandler

End Function

Public Function GetTemp() As Variant
    ' send temperature query command to the chamber
    lngStatus = viVPrintf(lngDcsp, "TEMP?"& Chr$(10), 0)
    If (lngStatus <> VI_SUCCESS) Then GoTo VisaErrorHandler

    ' reads the result.
    lngStatus = viVScanf(lngDcsp, "%t", strRes)
    If (lngStatus <> VI_SUCCESS) Then GoTo VisaErrorHandler

End Function

Public Function SetTemp(vntSettingTemp As Variant)
    ' set temperature
    lngStatus = viVPrintf(lngDcsp, "TEMP,S"& vntSettingTemp & Chr$(10), 0)
    If (lngStatus <> VI_SUCCESS) Then GoTo VisaErrorHandler

    ' reads the result.
    lngStatus = viVScanf(lngDcsp, "%t", strRes)
    If (lngStatus <> VI_SUCCESS) Then GoTo VisaErrorHandler

End Function

Private Function CurrentTemp(strResponse As String) As Variant
    Dim strTempList() As String ' temperature data list

    strTempList() = Split(strResponse, ",")
    CurrentTemp = ConvertStrT toDbl(strTempList(0))

End Function
    
```

e4991aaj225

C. Temperature Characteristic  
 Test Kit (Option 007)

## Temperature Characteristic Test Kit (Option 007) Modifying attached sample program

### When using temperature chambers that can control temperature and humidity

When you use a temperature chamber that can control temperature and humidity and you want to control humidity as well as temperature, change as described in “When using temperature chamber that can control temperature only” on page 372, then you have to complete GetHumid and SetHumid in the ChamberControl standard module and then change SetChamber in the frmCompenMeas and frmMainMeas form modules.

- **GetHumid**  
GetHumid is a function that checks the humidity of the temperature chamber. Since the recommended temperature chamber does not have the humidity control feature, it does nothing by default. Referring to the description of the temperature check (GetTemp), modify the program so that it sends a GPIB command that checks the humidity of the temperature chamber you use to check the humidity.
- **SetHumid**  
SetHumid is a function that sets the humidity of the temperature chamber. Since the recommended temperature chamber does not have the humidity control feature, it does nothing by default. Referring to the description of the temperature setting (SetTemp), modify the code so that it sends a GPIB command that sets the humidity of the temperature chamber you use to set the humidity.
- **SetChamber**  
SetChamber is a function that sets the temperature and humidity of the temperature chamber as you specified. Change the part that judges whether the temperature chamber reaches the specified conditions (enclosed with a thick box in Figure C-44) so that the judgment is performed using the humidity check result (vntCurHumid) in addition to the temperature check result (vntCurTemp).

Figure C-44

### Part of SetChamber to be changed (part of form modules, frmCompenMeas/frmMainMeas)

```
Private Function SetChamber(intTempPoint As Integer, lngMeasStartTime As Long)
    .....
    ' check current temperature and display data in every 2 seconds
    ' if current temperature reaches within +-2deg of set temp, exit loop
    Do Until ((muTempData(intTempPoint).Temp - 2 < vntCurTemp And vntCurTemp <
    < muTempData(intTempPoint).Temp + 2)
        ' get current time
        lngTickCount = GetTickCount

        ' get current temperature
        vntCurTemp = GetTemp()
        If gblnAbortMeas = True Then GoTo AbortMeasurement

        ' get current humidity
        vntCurHumid = GetHumid()
        If gblnAbortMeas = True Then GoTo AbortMeasurement

        ' update displayed value on frmCompenMeas form
        UpdateMeasDisp UBound(muTempData), UBound(muTempData) - intTempPoint + 1, _
            lngTickCount - lngMeasStartTime, muTempData(intTempPoint).Temp, _
            muTempData(intTempPoint).Humid, vntCurTemp, vntCurHumid

        ' wait for 2 sec
        Wait lngTickCount, 2
        If gblnAbortMeas = True Then GoTo AbortMeasurement
    Loop
```

e4991aoj226

## Recovery of the sample program furnished the option 007

Performing the following steps will allow you to recover the sample program furnished with the option 007 Temperature Characteristic Test Kit when you purchased.

### Step 1. Exit from the E4991A system program

- a. Click **System - Exit** from the menu bar. This opens the **Enter Password to exit** dialog box (Figure C-45).

Figure C-45

#### Enter Password to exit dialog box



- b. Enter the password: **e4991a** into the **Password** box by using the character input dialog box that appears by clicking the **Keyboard...** button or by using the external keyboard.
- c. Exit from the **E4991A** system by clicking the **OK** button.

### Step 2. Insert the floppy disk furnished the option 007 into the E4991A floppy disk drive.

### Step 3. Double-click the icon **My Computer** on the E4991A display and double-click the A drive displayed in the window.

Figure C-46

#### My Computer Icon



### Step 4. Double-click the “Setup.msi” stored in the A drive and follow the on-screen instructions to install the sample program.

Temperature Characteristic Test Kit (Option 007)  
**Recovery of the sample program furnished the option 007**

---

## **D** **Menu References**

This appendix explains the E4991A functions available from the display's menu and cross references them to GPIB commands.

## Menu References

The buttons/boxes in the setup toolbar (right of display screen) are called up from the menu bar (upper screen) and front panel keys. In the list below, these are shown along with the functions they perform and the corresponding GPIB commands.

Each heading in the list indicates the following:

Menu Bar (Key)	A Menu Bar selection and the front panel key (shown in parentheses) having the same function.
Setup Toolbar	A button/box in the active setup toolbar.
Function	The function performed by the button/box.
GPIB Command	The GPIB command used for each function.

### Trace Menu

#### Trace - Scalar {1|2|3} | Complex {4|5}

Menu Bar (Key)	Setup Toolbar	Function	GPIB Command
<b>Trace</b> ( <span style="border: 1px solid black; padding: 0 2px;">Trace</span> )	Cannot access.		
-Scalar 1		Sets Trace 1 to Active Trace.	DISP:TRAC{1-5}:SEL
-Scalar 2		Sets Trace 2 to Active Trace.	DISP:TRAC{1-5}:SEL
-Scalar 3		Sets Trace 3 to Active Trace.	DISP:TRAC{1-5}:SEL
-Complex 4		Sets Trace 4 to Active Trace.	DISP:TRAC{1-5}:SEL
-Complex 5		Sets Trace 5 to Active Trace.	DISP:TRAC{1-5}:SEL




## Meas/Format Menu

### Meas/Format - Meas/Format...

Menu Bar (Key)	Setup Toolbar	Function	GPIB Command
<b>Meas/Format</b>			
<b>-Meas/Format</b> ( <u>Meas/Format</u> )	<b>Meas/Format:</b>		
	-Meas Parameter	Selects measurement parameter for the active trace. The available measurement parameter will depend on the measuring mode (impedance, derivative, magnetic measurement).	CALC{1-5}:FORM
	-Format	Set the display format for the active trace to the Y axis. The available display format will depend on the scalar trace and the complex trace.	DISP:TRAC{1-5}:GRAT:FORM DISP:TRAC{1-3}:Y:SPAC
	-Expand Phase[ ]	Available only when the active trace measurement parameter is $\theta_z$ , $\theta_y$ , or $\theta_\gamma$ . This function sets the phase expansion display for the active trace. When On it can display phase traces beyond $\pm 180^\circ$ without folding back.	CALC{1-3}:FORM:PAR:EPH
	-Phase Unit[ ]	Available only when the active trace measurement parameter is $\theta_z$ , $\theta_y$ , $\theta_\gamma$ . This function sets the phase display unit [Degree/Radian] for the active trace.	CALC{1-5}:FORM:UNIT:ANGL
	-Sweep Average[ ]	This function sets the sweep average for all of the traces [On/Off]. For more on sweep averaging, refer to “Averaging Plural Sweeps (Sweep-to-Sweep Averaging)” on page 71.	CALC:AVER
	-Swp Avg Count	Available only when sweep averaging is On. This function sets the sweep averaging count from 1 to 999.	CALC:AVER:COUN
	-Sweep Average Restart	Available only when sweep averaging is on. This function restarts the measurement and clears the sweep count to 1.	CALC:AVER:CLE

## Scale Menu

### Scale - Scale...(When Display Format is Linear)

Menu Bar (Key)	Setup Toolbar	Function	GPIB Command
<b>Scale</b>  -Scale... (  )	<b>Scale:</b>  -Autoscale All  -Autoscale  -Full Scale -(Top)  -Ref Val -(Bottom)  -Ref Pos  -Scale For  -Scale Entry[ ]  -Reference Line[ ]	Executes autoscale for all traces.  Executes autoscale for active trace.  Full Scale: Displayed when the <b>Scale Entry</b> box is set to <b>[Scale/Ref]</b> . Sets the active trace to the difference between the top line and the bottom line. (Top): Displayed when the <b>Scale Entry</b> box is set to <b>[Top/Bottom]</b> . Sets the value on the top line for the active trace.  Ref Val: Displayed when the <b>Scale Entry</b> box is set to <b>[Scale/Ref]</b> . Sets the reference line position for the active trace. (Bottom): Displayed when the <b>Scale Entry</b> box is set to <b>[Top/Bottom]</b> . Sets the bottom line value for the active trace.  Sets the reference line position for the active trace.  Selects target trace (data trace/memory trace/data & memory trace) for scaling.  Selects the input method of scale settings. Input box will depend on the selected method.  Sets reference line display [On/Off] for the active trace.	DISP:TRAC:Y:AUTO:ALL  DISP:TRAC{1-5}:Y:AUTO  Full Scale: DISP:TRAC{1-5}:Y:FULL Top: DISP:TRAC{1-3}:Y:TOP  Ref Val: DISP:TRAC{1-5}:Y:RLEV Bottom: DISP:TRAC{1-3}:Y:BOTT  DISP:TRAC{1-3}:Y:RPOS  DISP:TRAC{1-5}:Y:FOR  None  DISP:TRAC{1-3}:REF

**Scale - Scale...(When Display Format is Log)**

Menu Bar (Key)	Setup Toolbar	Function	GPIB Command
<b>Scale</b> -Scale... ( <input type="button" value="Scale"/> )	<b>Scale:</b>  -Autoscale All  -Autoscale  -Top  -Bottom  -Scale For	Executes autoscale for all traces.  Executes autoscale for active trace.  Sets the value on top line for active trace.  Sets the value on bottom line for active trace.  Sets the target trace (data trace/memory trace/data & memory trace) for scaling.	DISP:TRAC:Y:AUTO:ALL  DISP:TRAC{1-5}:Y:AUTO  DISP:TRAC{1-3}:Y:TOP  DISP:TRAC{1-3}:Y:BOTT  DISP:TRAC{1-5}:Y:FOR

**Scale - Scale...(When Display Format is Polar)**

Menu Bar (Key)	Setup Toolbar	Function	GPIB Command
<b>Scale</b> -Scale... ( <input type="button" value="Scale"/> )	<b>Scale:</b>  -Autoscale All  -Autoscale  -Scale  -Scale For	Executes autoscale for all traces.  Executes autoscale for active trace.  Sets the size from the origin to the outermost circle for active trace.  Selects the subject trace (data trace/memory trace/data & memory trace) for scaling.	DISP:TRAC:Y:AUTO:ALL  DISP:TRAC{1-5}:Y:AUTO  DISP:TRAC{1-5}:Y:FULL  DISP:TRAC{1-5}:Y:FOR

Menu References  
Menu References

**Scale - Scale...(When Display Format is Complex Plane)**

Menu Bar (Key)	Setup Toolbar	Function	GPIB Command
<b>Scale</b>  -Scale... ( Scale )	<b>Scale:</b>  -Autoscale All  -Autoscale  -Scale  -Ref X  -Ref Y  -Scale For	  Executes autoscale for all traces.  Executes autoscale for active trace.  Sets the length per scale for active trace.  Sets the reference line value in the horizontal (X) axis for active trace.  Sets the reference line value in the vertical (Y) axis for active trace.  Selects the target trace (data trace/memory trace/data & memory trace) for scaling.	  DISP:TRAC:Y:AUTO:ALL  DISP:TRAC{1-5}:Y:AUTO  DISP:TRAC{1-5}:Y:FULL  DISP:TRAC{4-5}:X:RLEV  DISP:TRAC{1-5}:Y:RLEV  DISP:TRAC{1-5}:Y:FOR

**Scale - Scale...**  
**(When Display Format is Smith/Admittance Chart)**

Menu Bar (Key)	Setup Toolbar	Function	GPIB Command
<b>Scale</b>  -Scale... ( Scale )	<b>Scale:</b>  -Autoscale All  -Scale For	  Executes autoscale for all traces.  Selects the target trace (data trace/memory trace/data & memory trace) for scaling.	  DISP:TRAC:Y:AUTO:ALL  DISP:TRAC{1-5}:Y:FOR

**Scale - Autoscale All**

Menu Bar (Key)	Setup Toolbar	Function	GPIB Command
<b>Scale</b>  -Autoscale All	Cannot access.	Same function as <b>Scale - Scale - Autoscale All</b> .	DISP:TRAC:Y:AUTO:ALL

**Scale - Autoscale**

<b>Menu Bar (Key)</b>	<b>Setup Toolbar</b>	<b>Function</b>	<b> GPIB Command</b>
<b>Scale</b> <b>-Autoscale</b>	Cannot access.	Same function as <b>Scale - Scale - Autoscale</b> .	DISP:TRAC{1-5}:Y:AUTO

## Display Menu

### Display - Display...

Menu Bar (Key)	Setup Toolbar	Function	GPIB Command
<b>Display</b>  -Display... ( <u>Display</u> )	<b>Display:</b>  -Num Of Traces  -Display Scalar Trace[ ]  -Copy Data→Memory  -Define Trace  -Math Offset  -List Values[ ]  -Print/Clipboard Menu  -More	  Sets the number of traces displayed. Can display scalar trace (number of traces: 1-3) and/or complex trace (number of traces: 1-2).  When there is more than one trace, selects whether to display all traces in a single window [Overlay] or to split the traces and display each in its own window individually [Split].  Stores into memory currently measured raw data (R-X format) and data trace displayed after being converted into set measurement parameters for all traces in the window of the active trace. The offset value, if any, will be subtracted from the data trace before it is stored. Also, only one memory trace can be saved for each data trace.  Selects the method for displaying the active trace (Data Trace/Memory Trace/Data & Memory Trace/calculated traces of Data – Memory and Delta %).  Available only in scalar trace. Sets amount to be subtracted (offset value) from the active trace.  For the window that displays the active trace, sets the list display mode [On (Display List)/Off (Display Graph)] for the data trace.  Calls up the setup toolbar that selects the screen printing content and copying format. For details see “Display - Display - Print/Clipboard Menu” on page 385.  Calls up the 2nd page of the <b>Display</b> toolbar. For details see “Display - Display - More” on page 384”	  DISP:TRAC{1-5}  DISP:FORM  CALC{1-5};MATH:MEM  CALC{1-5};MATH:FUNC  CALC{1-3};MATH:OFFS  DISP:TRAC{1-5}:TEXT

### Display - Display - More

Menu Bar (Key)	Setup Toolbar	Function	GPIB Command
<b>Display</b>  -Display... ( <u>Display</u> )	-More  <b>Display:</b>		

Menu Bar (Key)	Setup Toolbar	Function	GPIB Command
	-Color Setting Menu	Calls up the setup toolbar that sets the trace, background, and grid colors. For details see “Display - Display - More - Color Setting Menu” on page 386.	
	-Title	Sets the title for the active trace, which is displayed as text in the upper part of the screen.	DISP:TRAC{1-5}:TITL:DATA DISP:TRAC{1-5}:TITL
	-Window Maximize	Maximizes the window where the active trace is displayed.	None
	-Window Restore	Restores the maximized window back to normal.	None
	-Freq Disp Resolution	Sets the resolution of the marker frequency display.	None
	-Operation Param Menu	Calls up the setup toolbar that displays a list of setting statuses for measurement conditions, calibration, and fixture compensation. For details see “Display - Display - More - Operation Param Menu” on page 387.	

**Display - Display - Print/Clipboard Menu**

Menu Bar (Key)	Setup Toolbar	Function	GPIB Command
<b>Display</b> -Display... ( <u>Display</u> )	-Print/Clipbd Menu  <b>Print/Clipbd:</b> -Print Graph(Color)  -Print Graph(Mono)  -Print List Values  -Print Operating Params	  Prints graph of measurement data displayed on screen in color. For more on printing, refer to “Printing Measurement Graphs and Internal Data Lists” on page 186.  Prints measurement data graph displayed on screen in black and white.  Prints list of measurement data from all measuring points.  Prints list of primary parameters related to measurement conditions.	  HCOP:CONT HCOP:IMAG HCOP  HCOP:CONT HCOP:IMAG HCOP  HCOP:CONT HCOP
	-Copy to Clipboard Graph(bmp)	Available only when remote user interface is On (when E4991A User Interface program is operating on an external PC). Copies graph display of data trace to the clipboard in bmp format. When more than one window is open, the function will only copy the window with the active trace.	None

Menu References  
Menu References

Menu Bar (Key)	Setup Toolbar	Function	GPIB Command
	-Copy to Clipboard Graph(jpg)	Only available when the remote user interface is On. Copies graph display of data trace to the clipboard in jpg format. When more than one window is open, the function will only copy the window with the active trace.	None
	-Copy to Clipboard List Values	Only available when the remote user interface is On. Copies list of data trace from all measuring points to the clipboard.	None
	-Copy to Clipboard Operating Params	Only available when the remote user interface is On. Copies list of primary parameters related to measurement conditions to the clipboard.	None

**Display - Display - More - Color Setting Menu**

Menu Bar (Key)	Setup Toolbar	Function	GPIB Command
<b>Display</b>			
-Display... ( <u>Display</u> )	-More		
	-Color Setting Menu		
	<b>Color Setting:</b>		
	-Item	Selects the coloring object. Able to select trace (data trace/memory trace), background, or grid.	None
	-Red	Adjusts red luminosity from 0 to 255 degrees.	None
	-Green	Adjusts green luminosity from 0 to 255 degrees.	None
	-Blue	Adjusts blue luminosity from 0 to 255 degrees.	None
	-Default	Resets all coloring parameters to the initial setting.	None



**Display - Display - More - Operation Param Menu**

Menu Bar (Key)	Setup Toolbar	Function	GPIB Command
<b>Display</b> <b>-Display...</b> ( <b>Display</b> )	-More  -Operation Param Menu  <b>Display:</b> -Operation Parameters  -Cal Status/Kit  -Comp Status/Kit	Displays a list of primary parameters related to the measurement conditions.  Displays a list of calibration statuses and standard values of the calibration kit.  Displays a list of fixture compensation statuses and standard values of fixture compensation kit.	None  None  None

**Display - Window**

Menu Bar (Key)	Setup Toolbar	Function	GPIB Command
<b>Display</b> <b>-Window</b>  <b>-Maximize</b>  <b>-Restore</b>	Cannot access.  Cannot access.	Same function as <b>Display - Display - More - Window Maximize</b> .  Same function as <b>Display - Display - More - Window Restore</b> .	None  None

**Display - Print**

Menu Bar (Key)	Setup Toolbar	Function	GPIB Command
<b>Display</b> <b>-Print</b>  <b>-Graph (Color)</b>  <b>-Graph (Mono)</b>	Cannot access.  Cannot access.	Same function as <b>Display - Display - Print/Clipbd Menu - Print Graph (Color)</b>  Same function as <b>Display - Display - Print/Clipbd Menu - Print Graph (Mono)</b>	HCOP:CONT HCOP:IMAG HCOP  HCOP:CONT HCOP:IMAG HCOP

Menu References  
Menu References

Menu Bar (Key)	Setup Toolbar	Function	GPIB Command
-List Values	Cannot access.	Same function as <b>Display - Display</b> - Print/Clipbd Menu - Print List Values.	HCOP:CONT HCOP
-Operating Parameters	Cannot access.	Same function as <b>Display - Display</b> - Print/Clipbd Menu - Print Operating Params.	HCOP:CONT HCOP

**Display - Copy to Clipboard**

Menu Bar (Key)	Setup Toolbar	Function	GPIB Command
<b>Display</b>			
-Copy to Clipboard			
-Graph (bmp)	Cannot access.	Same function as <b>Display - Display</b> - Print/Clipbd Menu - Copy to Clipboard Graph (bmp).	None
-Graph (jpg)	Cannot access.	Same function as <b>Display - Display</b> - Print/Clipbd Menu - Copy to Clipboard Graph (jpg).	None
-List Values	Cannot access.	Same function as <b>Display - Display</b> - Print/Clipbd Menu - Copy to Clipboard List Values.	None
-Operating Parameters	Cannot access.	Same function as <b>Display - Display</b> - Print/Clipbd Menu - Copy to Clipboard Operating Params.	None

## Marker Menu

### Marker - Marker...

Menu Bar (Key)	Setup Toolbar	Function	GPIB Command
<b>Marker</b>			
<b>-Marker...</b> ( <b>Marker</b> )	<b>Marker:</b>		
	-Select Marker	Selects a marker number and displays it as a new marker. If the marker number is already displayed, it becomes the active marker. The marker point of the active marker is indicated by a large triangle ( $\Delta$ ). The reference marker (Marker R) can be used as a normal marker as well as a reference value in $\Delta$ mode. When the trace-to-trace marker coupling is disconnected, the active trace's marker is automatically selected.	CALC{1-5}:MARK:REF CALC{1-5}:MARK{1-8} CALC{1-5}:MARK:REF:ACT CALC{1-5}:MARK{1-8}:ACT
	-Stimulus	Sets the stimulus value for the active marker and moves it to that position. The measurement and stimulus values are displayed in the screen's upper area.	CALC{1-5}:MARK:REF:X CALC{1-5}:MARK{1-8}:X
	-Selected Marker[ ]	Turns off the active marker display.	CALC{1-5}:MARK:REF CALC{1-5}:MARK{1-8}
	-Marker On[ ]	Available only when both data trace and memory trace are displayed. Sets the active trace as the trace that uses the marker and selects either data trace or memory trace.	CALC{1-5}:MARK:ON
	-Delta Marker Menu	Calls up the setup toolbar that selects the reference marker mode and setting. For details see "Marker - Marker - Delta Marker Menu" on page 390.	
	-Marker To Menu	Calls up the setup toolbar that inputs the active marker's stimulus or measurement value as the setting for each function. A marker is displayed if there is none active yet. For details see "Marker - Marker - Marker To Menu" on page 391.	
	-All Off	Turns off all markers displayed for all traces. If the trace-to-trace marker function is not on, only the markers displayed in the active trace will be turned off.	CALC{1-5}:MARK:AOFF
	-More	Calls up the 2nd page of the <b>Marker</b> toolbar. For details see "Marker - Marker - More" on page 389.	

### Marker - Marker - More

Menu Bar (Key)	Setup Toolbar	Function	GPIB Command
<b>Marker</b>			
<b>-Marker...</b> ( <b>Marker</b> )	-More		

Menu References  
Menu References

Menu Bar (Key)	Setup Toolbar	Function	GPIB Command
	<p><b>Marker:</b></p> <p>-Marker[ ]</p>	<p>Toggles the Continuous marker mode ([Continuous]) and Discrete marker mode ([Discrete]). In Continuous mode, the marker can read any selected point value on an active trace by interpolating. In Discrete mode, the marker can only read measurement points.</p>	<p>CALC{1-5}:MARK:DISC</p>
	<p>-Coupled Marker[ ]</p>	<p>Sets the Continuous marker function [On/Off]. When On, the marker moves all traces. When Off, the marker moves the active trace only.</p>	<p>CALC:MARK:COUP</p>

**Marker - Marker - Delta Marker Menu**

Menu Bar (Key)	Setup Toolbar	Function	GPIB Command
<p><b>Marker</b></p> <p>-Marker... (Marker)</p>	<p>-Delta Marker Menu</p> <p><b>Delta Marker:</b></p> <p>-Delta Mode</p>	<p>Available only when the reference marker is On. Selects the reference marker mode from among <math>\Delta</math> mode off (OFF), <math>\Delta</math> mode (Delta), and fixed <math>\Delta</math> mode (Fixed Delta).</p> <p>In <math>\Delta</math> mode off, the active marker stimulus and measurement values are shown in the upper area of the screen.</p> <p>In <math>\Delta</math> mode, the differences between the measurement values and the stimulus value for the active marker and reference marker are shown in the upper area of the screen.</p> <p>In fixed <math>\Delta</math> mode, the reference marker can be set to any location by the user (it does not have to be on the trace). The differences between the measurement values and the stimulus value for the active marker and reference marker are shown in the upper area of the screen.</p>	<p>CALC{1-5}:MARK:REF:TYP E</p>

Menu Bar (Key)	Setup Toolbar	Function	PIB Command
	-Stimulus	Available only when the reference marker is in $\Delta$ mode or fixed $\Delta$ mode. Sets the reference marker stimulus value and moves it to that position.	CALC{1-5}:MARK:REF:X
	-Delta Value	Available only when the reference marker is in fixed $\Delta$ mode. Sets the reference marker measurement value and moves it to that position.	CALC{1-5}:MARK:REF:Y
	-Delta Aux Value	Available only when the reference marker is in fixed $\Delta$ mode and the display is in polar, complex plane, Smith Chart, or Admittance Chart format. Sets the reference marker's auxiliary measurement value and moves it to that position.	CALC{1-5}:MARK:REF:Y

### Marker - Marker - Marker To Menu

Menu Bar (Key)	Setup Toolbar	Function	PIB Command
<b>Marker</b>			
-Marker... (Marker)	-Marker To Menu		
	<b>Marker To:</b>		
	-Start	Sets the active marker's stimulus value as the sweep starting value for all traces and changes the sweep range accordingly as the new sweep starting value.	CALC{1-5}:MARK:SET
	-Stop	Sets the active marker's stimulus value as the sweep stopping value for all traces and changes the sweep range accordingly as the new sweep stopping value.	CALC{1-5}:MARK:SET
	-Center	Sets the active marker's stimulus value as the sweep centering value for all traces and changes the sweep range accordingly as the new sweep centering value.	CALC{1-5}:MARK:SET
	-Delta To Span	Available only when the reference marker is in $\Delta$ mode or fixed $\Delta$ mode and any marker other than the reference marker is selected in the <b>Select Marker</b> box. Sets the stimulus differences for the active marker and reference marker to the sweep span value and changes the sweep range accordingly as the new sweep span value.	CALC{1-5}:MARK:SET

Menu References  
Menu References

Menu Bar (Key)	Setup Toolbar	Function	GPIB Command
	-Reference	Available only when the display is in linear format. Sets the active marker measurement value in the active trace as the scale reference value and changes the scale accordingly as the new reference value. The scale reference value refers to the <b>Ref Val</b> box in “Scale - Scale...(When Display Format is Linear)” on page 380.	CALC{1-5}:MARK:SET
	-Offset	Available only in scalar trace. Sets the active marker measurement value in the active trace as an offset value and sets the trace as the new offset value. The new offset value refers to the settings in <b>Math Offset</b> box in “Display - Display...” on page 384.	CALC{1-5}:MARK:SET

**Marker - Function...**

Menu Bar (Key)	Setup Toolbar	Function	GPIB Command
<b>Marker</b>			
-Function... ( Marker Fctn )	<b>Marker Fctn:</b>		
	-Search	Executes marker search function for an active trace. This function searches for the points that match the conditions selected in the <b>Search Type</b> box.	CALC{1-5}:MARK:FUNC:EXEC
	-Search Type	Selects the search type for the active trace. The search type can be selected from Maximum, Minimum, Target, Positive Peak, Negative Peak.	CALC{1-5}:MARK:FUNC
	-Next	Available only in peak search. If the peak search is set to Positive Peak, the function will search for the next smallest positive peak from the last search (positive peak measurement). If the peak search is set to Negative Peak, the function will search for the next largest negative peak from the last search (negative peak measurement).	CALC{1-5}:MARK:FUNC:EXEC:NEXT
	-Left	Available in peak search and target search. Searches for the peak value or target value on the left side of the active marker.	CALC{1-5}:MARK:FUNC:EXEC:LEFT

Menu Bar (Key)	Setup Toolbar	Function	GPIB Command
	-Right	Available in peak search and target search. Searches for the peak value or target value on the right side of the active marker.	CALC{1-5}:MARK:FUNC:EXEC:RIGH
	-Search Track[ ]	Sets the search track [On/Off] for the active trace. This function will execute a new search every time the trace has been updated by sweep.	CALC{1-5}:MARK:FUNC:TRACE
	-Search Def&Range Menu	Calls up the setup toolbar that sets the partial search, peak definition, and target value for target search. For details see “Marker - Function - Search Def&Range Menu” on page 394.	
	-More	Calls up the 2nd page of the <b>Marker Fctn</b> toolbar. For details see “Marker - Function - More” on page 393.	

**Marker - Function - More**

Menu Bar (Key)	Setup Toolbar	Function	GPIB Command
<b>Marker</b> -Function... ( <b>Marker Fctn</b> )	-More		
	<b>Marker Fctn:</b>		
	-Marker List[ ]	Executes the marker list function [On/Off] for the active trace. This function lists up the stimulus and measurements values for all of the markers ( $\Delta$ mode and fixed $\Delta$ mode are included).	CALC{1-5}:MARK:LIST
	-Statistics[ ]	Executes statistics function [On/Off] when the active trace has a marker displayed. When On, the screen will calculate and display the statistical figures of the total trace (average, standard deviation, peak-to-peak between the marker). If partial search function is set to On, the function will calculate and display within that search area. If the display is in polar, complex plane, Smith Chart, or Admittance Chart format, the statistical figures are displayed by the absolutes of the complex numbers.	CALC{1-5}:MST
	-Smith/Polar	Selects the display format when calling the active marker measurement value for the active trace if the display is complex trace (polar, complex plane, Smith Chart, Admittance Chart).	CALC{4-5}:MARK:FORM

Menu References  
Menu References


Menu Bar (Key)	Setup Toolbar	Function	GPIB Command
	-Marker X Axis	Selects the marker X axis display method used for all traces. The method is selected from among stimulus, sweep time (the time it takes to reach the active marker from the sweep start as 0 (s)), or relaxation time ( $1/2\pi f$ , f: measured frequency).	CALC{1-5}:MARK:UNIT
	-Limit Test Menu	Calls up the setup toolbar that sets the limit test function and displays the limit test table. For details see “Marker - Function - More - Limit Test Menu” on page 395.	

**Marker - Function - Search Def&Range Menu**

Menu Bar (Key)	Setup Toolbar	Function	GPIB Command
<b>Marker</b>			
-Function... (Marker Fctn)	-Search Def&Range Menu		
	<b>Def &amp; Range:</b>		
	-Partial Search[ ]	Selects partial search function [On/Off] for the active trace. This function sets the sweep range for the marker search. This search area range is indicated by double vertical lines.	CALC{1-5}:MARK:FUNC:DOM
	-Marker to Left Range	Available when the Partial Search function is On. Draws a left range line on the stimulus value of the active marker position and sets it as the starting point for the partial search range.	CALC{1-5}:MARK:FUNC:DOM:STAR
	-Marker to Right Range	Available when Partial Search is On. Draws a right range line on the stimulus of the active marker position and set it as the ending point for the partial search range.	CALC{1-5}:MARK:FUNC:DOM:STOP
	-Mkr Delta to Search Range	Available when the reference marker mode is in $\Delta$ mode or fixed $\Delta$ mode and Partial Search is On. Sets the stimulus value ranges for the active and reference markers as the partial search range.	CALC{1-5}:MARK:FUNC:DOM:SPAN
	-Target Value	For the active trace, sets the target value for the Target Search (target measurement). If the reference marker is set to $\Delta$ mode or fixed $\Delta$ mode, the target value is the relative value based on the reference marker.	CALC{1-5}:MARK:FUNC:TARG
	-Peak Delta X	Sets the $\Delta X$ in the incline $\Delta X/\Delta Y$ that defines the peak in the active trace.	CALC{1-5}:MARK:APE:EXC:X
	-Peak Delta Y	Sets the $\Delta Y$ in the incline $\Delta X/\Delta Y$ that defines the peak in the active trace.	CALC{1-5}:MARK:APE:EXC:Y
	-Marker to Peak Delta	Compares the incline from the active marker position to the measurement points on both sides and sets the smaller one to the peak incline $\Delta X/\Delta Y$ .	CALC{1-5}:MARK:APE:SET



**Marker - Function - More - Limit Test Menu**

Menu Bar (Key)	Setup Toolbar	Function	GPIB Command
<b>Marker</b>			
-Function... (  )	-More		
	-Limit Test Menu		
	<b>Limit Test:</b>		
	-Limit Test[ ]	Executes the limit test function for the active trace [On/Off]. This function compares the limit value defined in each marker position (upper limit, lower limit) and the measurement data and then displays the results (Pass/Fail) in the bottom right corner of the screen. In complex trace, the limit value is defined by the format set in the <b>Smith/Polar</b> box (the first numerical number value or absolute value displayed among the two markers).	CALC{1-5}:MARK:FUNC:DOM:LIM:ALL
	-Select Marker	Selects the marker number for the limit test. The screen displays the newly selected marker number if it is not already shown.	CALC{1-5}:MARK:REF CALC{1-5}:MARK{1-8} CALC{1-5}:MARK:REF:ACT CALC{1-5}:MARK{1-8}:ACT
	-Test Marker[ ]	Selects whether to use the marker selected in the <b>Select Marker</b> box for the limit test [On/Off].	CALC{1-5}:MARK:REF:FUN C:DOM:LIM CALC{1-5}:MARK{1-8}:FUN C:DOM:LIM
	-Stimulus	Set the stimulus value of the marker selected in the <b>Select Marker</b> box for the active trace.	CALC{1-5}:MARK:REF:X CALC{1-5}:MARK{1-8}:X
	-Upper	Sets the upper limit of the marker measurement selected in the <b>Select Marker</b> box for the active trace.	CALC{1-5}:MARK:REF:FUN C:DOM:LIM:UP CALC{1-5}:MARK{1-8}:FUN C:DOM:LIM:UP
	-Lower	Sets the lower limit point of the marker measurement selected in the <b>Select Marker</b> box for the active trace.	CALC{1-5}:MARK:REF:FUN C:DOM:LIM:LOW CALC{1-5}:MARK{1-8}:FUN C:DOM:LIM:LOW

**Marker - To...**

Menu Bar (Key)	Setup Toolbar	Function	GPIB Command
<b>Marker</b>			
-To...	<b>Marker To:</b>	Same function as <b>Marker - Marker - Marker To</b> Menu	

Menu References  
**Menu References**

**Marker - Fctn More...**

Menu Bar (Key)	Setup Toolbar	Function	GPIB Command
<b>Marker</b> -Fctn More...	<b>Marker Fctn:</b>	Same function as <b>Marker - Function - More.</b>	

**Marker - Limit...**


Menu Bar (Key)	Setup Toolbar	Function	GPIB Command
<b>Marker</b> -Limit...	<b>Limit Test:</b>	Same function as <b>Marker - Function - More - Limit Test Menu.</b>	

**Marker - All Off**

Menu Bar (Key)	Setup Toolbar	Function	GPIB Command
<b>Marker</b> -All Off	Cannot access.	Same function as <b>Marker - Marker - All Off.</b>	CALC{1-5};MARK:AOFF

**Stimulus Menu**

**Stimulus - Start/Stop...**

Menu Bar (Key)	Setup Toolbar	Function	GPIB Command
<p><b>Stimulus</b></p> <p>-Start/Stop... (  )</p>	<p><b>Start/Stop:</b></p> <p>-Start</p> <p>-Stop</p> <p>-Center</p>	<p>Sets the sweep starting value.</p> <p>Sets the sweep stopping value.</p> <p>Sets the sweep center value.</p>	<p>Frequency sweep: FREQ:STAR Oscillator level (dBm) sweep: SOUR:POW:STAR Oscillator level (voltage) sweep: SOUR:VOLT:STAR Oscillator level (current) sweep: SOUR:CURR:STAR Dc bias (voltage) sweep: SOUR:VOLT:OFFS:STAR Dc bias (current) sweep: SOUR:CURR:OFFS:STAR</p> <p>Frequency sweep: FREQ:STOP Oscillator level (dBm) sweep: SOUR:POW:STOP Oscillator level (voltage) sweep: SOUR:VOLT:STOP Oscillator level (current) sweep: SOUR:CURR:STOP Dc bias (voltage) sweep: SOUR:VOLT:OFFS:STOP Dc bias (CURRENT) sweep: SOUR:CURR:OFFS:STOP</p> <p>Frequency sweep: FREQ:CENT Oscillator level (dBm) sweep: SOUR:POW:CENT Oscillator level (voltage) sweep: SOUR:VOLT:CENT Oscillator level (current) sweep: SOUR:CURR:CENT Dc bias (voltage) sweep: SOUR:VOLT:OFFS:CENT Dc bias (current) sweep: SOUR:CURR:OFFS:CENT</p>



Stimulus - Sweep Setup...

Menu Bar (Key)	Setup Toolbar	Function	GPIB Command
<b>Stimulus</b>  -Sweep Setup... ( Sweep )	<b>Sweep Setup:</b>  -Number Of Points  -Point Average  -Sweep Time[ ]  -Sweep Parameter  -Sweep Type  -Sweep Direction[ ]  -Segment Table Menu  -Segment Display	<p>Sets the number of measurement points (NOP) in integers from 2 to 801. The larger the NOP is, the better the resolution becomes but the longer the sweep time becomes. The smaller the NOP is, the shorter the sweep time becomes but the trace resolution decreases.</p> <p>Sets the point averaging factor (done at each measurement point) in integers from 1 to 100. An averaging factor of two or more will automatically turn Point Average On and start point averaging. Setting averaging to 1 sets up the same condition as Point Average Off.</p> <p>Calls up the setup toolbar that sets the sweep time and delay time. For details see “Stimulus - Sweep Setup - Sweep Time[ ]” on page 400.</p> <p>Selects the sweep parameter from Frequency, Power (oscillation level), Bias Voltage, or Bias current.</p> <p>Selects the sweep type from Linear, Log, or Segment if Frequency is selected as the sweep parameter. However, to select Segment it is necessary to set up the segment sweep table beforehand from the <b>Segment Table Menu</b>. Linear is automatically selected if the sweep parameter is set to Power or Bias Voltage (current).</p> <p>Switches the sweep direction up &amp; down. Up starts the sweep from the sweep start position and ends it at the sweep end position. Down starts the sweep from the sweep stop position and ends it at the sweep start position.</p> <p>Calls up the setup toolbar that creates the segment sweep table. For details see “Stimulus - Sweep Setup - Segment Table Menu” on page 400. Segment sweep function sweeps according to the previously set frequency ranges (segments) in a single sweep.</p> <p>Available only when Segment Sweep is selected as the sweep type. Selects the display method of the measured data trace by using the segment sweep function. The display can be selected from Frequency linear (Freq Base), segment number order (Order base), or Frequency log (Log Freq Base).</p>	<p>SWE:POIN</p> <p>AVER:COUN AVER</p> <p>SWE:TYPE</p> <p>SWE:TYPE</p> <p>SWE:DIR</p> <p>DISP:TRAC{1-5}:X:SPAC</p>

Menu References  
Menu References

**Stimulus - Sweep Setup - Sweep Time[ ]**

Menu Bar (Key)	Setup Toolbar	Function	GPIB Command
<b>Stimulus</b>  <b>-Sweep Setup...</b> ( <b>Sweep</b> )	-Sweep Time[ ]		
	<b>Sweep Time:</b>  -Sweep Time Auto[ ]	Switches the sweep time from manual (sets sweep time to any selected time) to auto (sets sweep time automatically). Setting the sweep time by using the <b>Sweep Time</b> box automatically changes the setting to manual.	SWE:TIME:AUTO
	-Sweep Time	Sets sweep time to any given time.	SWE:TIME
	-Point Delay	Sets the point delay time (measurement point delay time). The start of measurement for each measurement point is delayed by the amount of delay time set.	SWE:DWEL2
	-Segment Delay	Sets the segment delay time (segment sweep delay time). By using this function, each segment sweep is delayed by the set delay time.	SWE:DWEL3
	-Sweep Delay	Sets the sweep delay time. By using this function, each sweep is delayed by the set delay time.	SWE:DWEL1

**Stimulus - Sweep Setup - Segment Table Menu**

Menu Bar (Key)	Setup Toolbar	Function	GPIB Command
<b>Stimulus</b>  <b>-Sweep Setup...</b> ( <b>Sweep</b> )	-Segment Table Menu		
	<b>Segment Table:</b>  -Add Segment	Adds a new segment to the Segment Sweep Table. If the table has no segment defined at all, one with the initial settings is added. If there already is a segment defined in the table, the last defined segment is copied and added. A maximum of 16 segments can be added.	SEGM:COUN
	-Segment No.	Selects the segment number that needs editing from the segments that compose the Segment Sweep Table.	None
	-Start	Sets the sweep start frequency for the selected segment number.	SEGM{1-16}:FREQ:STAR
	-Stop	Sets the sweep stop frequency for the selected segment number.	SEGM{1-16}:FREQ:STOP

Menu Bar (Key)	Setup Toolbar	Function	GPIB Command
	<ul style="list-style-type: none"> <li data-bbox="451 310 613 331">-Number Of Points</li> <li data-bbox="451 436 581 457">-Point Average</li> <li data-bbox="451 510 597 531">-Delete Segment</li> <li data-bbox="451 562 508 583">-More</li> </ul>	<p data-bbox="683 310 1115 415">Sets the number of measurement points for the selected segment number from 2 to 801. However, the total number of all segments cannot exceed the maximum of 801.</p> <p data-bbox="683 436 1047 489">Sets the number of point averaging for the selected segment numbers from 1 to 100.</p> <p data-bbox="683 510 938 531">Deletes the selected segment.</p> <p data-bbox="683 562 1109 636">Calls up the 2nd page of the <b>Segment Table</b> toolbar. For details see “Stimulus - Sweep Setup - Segment Table Menu - More” on page 402.</p>	<p data-bbox="1141 310 1377 331">SEGM{1-16}:SWE:POIN</p> <p data-bbox="1141 436 1398 489">SEGM{1-16}:AVER:COUN AVER</p> <p data-bbox="1141 510 1198 531">None</p>

Menu References  
Menu References

Stimulus - Sweep Setup - Segment Table Menu - More

Menu Bar (Key)	Setup Toolbar	Function	GPIB Command
<b>Stimulus</b>  <b>-Sweep Setup...</b> ( [Sweep] )	-Segment Table Menu  -More  <b>Segment Table:</b>  -Osc Level  -Osc Unit  -Bias Level  -Bias Limit  -Bias Source	Sets the oscillation level for the selected segment number.  Selects the oscillation level unit for all segment numbers. dBm, voltage, or current can be selected.  Sets the DC bias level for the selected segment numbers.  Sets the bias level limit (upper) when applying the DC bias for the selected segment number. When using DC bias in constant voltage mode, use current to set the upper limit. When using DC bias in constant current mode, use voltage to set the upper limit.  Selects the DC bias source when setting the DC bias level for the selected segment numbers. Select from constant voltage mode or constant current mode.	Oscillation level (dBm): SEGM{1-16}:POW Oscillation level (voltage): SEGM{1-16}:VOLT Oscillation level (current): SEGM{1-16}:CURR  Oscillation level (dBm): SEGM:POW:STAT Oscillation level (voltage): SEGM:VOLT:STAT Oscillation level (current): SEGM:CURR:STAT  DC Bias (voltage): SEGM{1-16}:VOLT:OFFS DC Bias (current): SEGM{1-16}:CURR:OFFS  DC Bias (voltage): SEGM{1-16}:VOLT:LIM DC Bias (current): SEGM{1-16}:CURR:LIM  DC Bias (voltage): SEGM:VOLT:OFFS:STAT DC Bias (current): SEGM:CURR:OFFS:STAT




Stimulus - Source...

Menu Bar (Key)	Setup Toolbar	Function	GPIB Command
<b>Stimulus</b>			
-Source... ( Source )	<b>Source:</b>		
	-Osc Level	Available when selecting a sweep parameter other than the oscillation level sweep. Sets the oscillation level.	Oscillation level (dBm): SOUR:POW Oscillation level (voltage): SOUR:VOLT Oscillation level (current): SOUR:CURR
	-Osc Unit	Selects the unit for setting the oscillation level from dBm, voltage, or current.	Oscillation level (dBm): SOUR:POW:MODE Oscillation level (voltage): SOUR:VOLT:MODE Oscillation level (current): SOUR:CURR:MODE
	-CW Freq	Available when selecting a sweep parameter other than frequency sweep. Sets the oscillation frequency.	FREQ
	-Bias Level	Available when selecting a sweep parameter other than DC bias. Sets the DC bias source level. The level of the set DC bias source is shown at the bottom of the screen when the <b>Dc Bias</b> button is On.	DC bias (voltage): SOUR:VOLT:OFFS DC bias (current): SOUR:CURR:OFFS
	-Bias Limit	Sets the level limit when applying DC bias (upper limit). When using DC bias in constant voltage mode, use current to set the upper limit. When using the constant current mode, use voltage. The set level limit is shown at the bottom of the screen when the <b>Dc bias</b> button is On.	DC bias (voltage): SOUR:VOLT:LIM:OFFS DC bias (current): SOUR:CURR:LIM:OFFS
	-Bias Source	Selects the DC bias source when setting DC bias source level. Selected from constant voltage or constant current mode.	DC bias (voltage): SOUR:VOLT:OFFS SOUR:CURR:LIM:OFFS SOUR:VOLT:OFFS:STAT DC bias (current): SOUR:CURR:OFFS SOUR:VOLT:LIM:OFFS SOUR:CURR:OFFS:STAT Note that the final command will be the top priority.
	-Bias Monitor[ ]	Switches the display that monitors the DC bias level applied in the samples. The monitor rate is shown below the marker only when the marker is shown. DC bias source level settings and the monitor rate do not necessarily match.	CALC:BMON
	-Dc Bias[ ]	Turns On/Off the DC bias source output. Turning the measurement Off→On activates the hold mode. When applying the DC bias, set the instrument to single trigger mode or continuous trigger mode before triggering.	DC bias (voltage): SOUR:VOLT:OFFS:STAT DC bias (current): SOUR:CURR:OFFS:STAT

Menu References  
Menu References

Stimulus - Cal/Compen...

Menu Bar (Key)	Setup Toolbar	Function	GPIB Command
<b>Stimulus</b>			
-Cal/Compen. (  )	<b>Cal/Compen:</b>		
	-Cal Menu[ ]	Calls up the setup toolbar for calibration and settings. For details see “Stimulus - Cal/Compen - Cal Menu[ ]” on page 405. Before calibration the Uncal is shown in the [ ]. After calibration it displays the calibrated data measurement points selected (Fix, FixR, User). See “Calibration/Compensation measurement point mode” on page 78 for calibrated data measurement points.	
	- Comp Menu[ ]	Calls up the setup toolbar for fixture compensation and settings. For details see “Stimulus - Cal/Compen - Comp Menu[ ]” on page 406. Before fixture compensation OFF is displayed in the [ ], but after fixture compensation ON is displayed. Buttons on the setup toolbar are enabled only when the calibration is completed.	
	-Cal Kit Menu	Calls up the setup toolbar for inputting the standard values when using the user defined calibration kit. For details see “Stimulus - Cal/Compen - Cal Kit Menu (Impedance/Magnetic)” on page 407 and “Stimulus - Cal/Compen - Cal Kit Menu (Derivatives)” on page 408.	
	-Comp Kit Menu	Only available in impedance measurement. Calls up the setup toolbar for inputting the standard values when using the user defined fixture compensation kit. For details see “Stimulus - Cal/Compen - Comp Kit Menu (Impedance Only)” on page 408.	
	-Fixture Type	Selects the test fixture. The available test fixtures are different depending on the mode (impedance, derivative, magnetic measurement). When using a user created test fixture, select <b>User</b> from the list.	SENS:CORR2:FIXT
	-Fxr Length	Available when using a user created test fixture. Sets the electrical length of the test fixture. When using an <b>Agilent</b> test fixture registered in the <b>Fixture Type</b> box, the standard rate for that test fixture is automatically set. When it is necessary to set a rate other than the standard rate, select <b>User</b> from the <b>Fixture Type</b> box and enter the desired electrical length.	SENS:CORR2:FIXT:EDEL:USER:DIST
	-Port Extension	Sets the offset delay time added to the test fixture’s electrical length when the 7-mm port is extended with a cable, etc.	SENS:CORR2:EDEL:TIME

Menu Bar (Key)	Setup Toolbar	Function	GPIB Command
	-Recover Cal/Comp State	Recovers the calibration/fixture compensation data and restores the instrument setups. For more on the instrument setups, refer to Appendix G on page 439.	None

**Stimulus - Cal/Compen - Cal Menu[ ]**

Menu Bar (Key)	Setup Toolbar	Function	GPIB Command
<b>Stimulus</b>			
-Cal/Compen. ( Cal/Compen )	-Cal Menu[ ]		
	<b>Calibration:</b>		
	-Meas Open	Measures the calibration data in the OPEN standard of the calibration kit. When the measurement is completed, there is a check mark (√) to the left of the button.	SENS:CORR1:COLL
	-Meas Short	Measures the calibration data in the SHORT standard of the calibration kit. When the measurement is over, there is a check mark (√) to the left of the button.	SENS:CORR1:COLL
	-Meas Load	Measures the calibration data in the LOAD standard of the calibration kit. When the measurement is over, there is a check mark (√) to the left of the button.	SENS:CORR1:COLL
	-Meas Low Loss C	Measures the low loss capacitor calibration data (attachment only) in the OPEN standard of the calibration kit. When the measurement is over, there is a check mark (√) to the left of the button. Low loss capacitor calibration is only necessary when High Q (low loss factor) measurement is done at high precision.	SENS:CORR1:COLL
	-Done -(Abort Cal Meas)	Done: Available when the measurement of the OPEN, SHORT, LOAD (low loss capacitor) calibration data is completed. The calibration coefficient is calculated based on the acquired 3 (4) calibration data, which are then stored into memory to enable calibration. (Abort Cal Meas): Available only in OPEN, SHORT, LOAD (low loss capacitor) calibration measurement. Aborts calibration measurement.	SENS:CORR1:COLL:SAVE (None)
	-Cal Reset	Disables all calibration data and the calibration coefficient acquired. When the button is clicked, the check mark (√) to the left of the button disappears.	SENS:CORR1

Menu References  
Menu References

Menu Bar (Key)	Setup Toolbar	Function	GPIB Command
	-Cal Type	Selects the calibration and fixture compensation data measurement point. The measurement point is selected from fixed frequency/ fixed power point mode (Fixed Freq & Pwr), Fixed frequency/ User defined power point mode (Fixed Freq, User Pwr), or User defined frequency/ user-defined power point mode (User Freq & Pwr). For details on the calibration data measurement points, see “Calibration/Compensation measurement point mode” on page 78.	SENS:CORR1:COLL:FPO SENS:CORR2:COLL:FPO

**Stimulus - Cal/Compen - Comp Menu [ ]**

Menu Bar (Key)	Setup Toolbar	Function	GPIB Command
<b>Stimulus</b>			
<b>-Cal/Compen.</b> ( Cal/ Compen )	-Comp Menu[ ]		
	<b>Compen:</b>		
	-Meas Open	Measures the OPEN compensation data. When the measurement is completed, there is a check mark (√) to the left of the button.	SENS:CORR2:COLL
	-Meas Short	Measures the SHORT compensation data. When the measurement is completed, there is a check mark (√) to the left of the button.	SENS:CORR2:COLL
	-Done -(Abort Compen Meas)	Done: Available when the measurement of the OPEN, SHORT compensation data is completed. The compensation coefficient is calculated based on the acquired fixture compensation data, which are then stored into memory to enable fixture compensation. (Abort Cal Meas): Available only in OPEN or SHORT data measurement. Aborts the fixture compensation data measurement.	SENS:CORR2:COLL:SAVE (None)
	-Comp Open[ ]	Switches On/Off the open compensation in fixture compensation. Compensation also turns On by simply clicking the <b>Done</b> button after measuring open compensation.	SENS:CORR2:COLL:OPEN
	-Comp Short[ ]	Switches On/Off the SHORT compensation in fixture compensation. SHORT Compensation also turns On by simply clicking the <b>Done</b> button after measuring SHORT compensation.	SENS:CORR2:COLL:SHOR

**Stimulus - Cal/Compen - Cal Kit Menu  
(Impedance/Magnetic)**

Menu Bar (Key)	Setup Toolbar	Function	GPIB Command
<b>Stimulus</b>			
<b>-Cal/Compen.</b> ( <u>Cal/ Compen</u> )	-Cal Kit Menu		
	<b>Cal Kit:</b>		
	-Cal Kit Type	Selects the calibration kit type from Standard (7 mm) or User Defined (User).	SENS:CORR1:CKIT
	-Open G	Available only when the User-Defined calibration kit is selected. Sets the conductance value (G) for the OPEN standard.	SENS:CORR1:CKIT:STAN1:G
	-Open C	Available only when the User-Defined calibration kit is selected. Sets the capacitance value (C) for the OPEN standard.	SENS:CORR1:CKIT:STAN1:C
	-Short R	Available only when the User-Defined calibration kit is selected. Sets the resistance value (R) for the SHORT standard.	SENS:CORR1:CKIT:STAN2:R
	-Short L	Available only when the User-Defined calibration kit is selected. Sets the inductance value (L) for the SHORT standard.	SENS:CORR1:CKIT:STAN2:L
	-Load R	Available only when the User-Defined calibration kit is selected. Sets the resistance value (R) for the LOAD standard.	SENS:CORR1:CKIT:STAN3:R
	-Load L	Available only when the User-Defined calibration kit is selected. Sets the inductance value (L) for the LOAD standard.	SENS:CORR1:CKIT:STAN3:L

Menu References  
Menu References

**Stimulus - Cal/Compen - Cal Kit Menu  
(Derivatives)**

Menu Bar (Key)	Setup Toolbar	Function	GPIB Command
<b>Stimulus</b>  <b>-Cal/Compen.</b> ( <b>Cal/Compen</b> )	-Cal Kit Menu		
	<b>Cal Kit:</b>		
	-Cal Kit Type	Automatically selects the LOAD standard (PTFE) as the dielectric calibration kit. Cannot be changed.	SENS:CORR1:CKIT
	-ε r Real	Sets the real part of the LOAD standard's complex relative permittivity ( $\epsilon_r'$ ).	SENS:CORR1:CKIT:STAN7:PRE
	-ε r Loss	Sets the imaginary part of the LOAD standard's complex relative permittivity ( $\epsilon_r''$ ).	SENS:CORR1:CKIT:STAN7:PLF
-Thickness	Sets the thickness of the LOAD standard.	SENS:CORR1:CKIT:STAN7:THIC	

**Stimulus - Cal/Compen - Comp Kit Menu  
(Impedance Only)**

Menu Bar (Key)	Setup Toolbar	Function	GPIB Command
<b>Stimulus</b>  <b>-Cal/Compen.</b> ( <b>Cal/Compen</b> )	-Comp Kit Menu		
	<b>Comp Kit:</b>		
	-Open G	Sets the conductance value (G) for the OPEN standard.	SENS:CORR2:CKIT:STAN1:G
	-Open C	Sets the capacitance value (C) for the OPEN standard.	SENS:CORR2:CKIT:STAN1:C
	-Short R	Sets the resistance value (R) for the SHORT standard.	SENS:CORR2:CKIT:STAN2:R
-Short L	Sets the inductance value (L) for the SHORT standard.	SENS:CORR2:CKIT:STAN2:L	

## Trigger Menu

### Trigger - Trigger

Menu Bar (Key)	Setup Toolbar	Function	GPIB Command
Trigger -Trigger ( <b>Trigger</b> )	Cannot access.	Available only when the trigger source is set to manual. Trigger is initiated once.	None

### Trigger - Trigger Setup...

Menu Bar (Key)	Setup Toolbar	Function	GPIB Command
Trigger -Trigger Setup... ( <b>Trigger Setup</b> )	Trigger Setup:		
	-Hold	Sets the Hold Mode, where no triggers are accepted, and stops measurement.	INIT:CONT
	-Single	Sets the single trigger mode, where one trigger makes one sweep before setting the hold mode. If sweep averaging is On, the system is set to hold mode after all of the sweeps set in the averaging count are completed.	INIT
	-Continuous	Sets the continuous trigger mode, where triggers are continuously selected. In this mode, sweep can be done continuously.	INIT:CONT
	-Trigger Source	Selects the trigger source. Triggers are selected from internal, manual, external, or GPIB.	TRIG:SOUR
	-Trigger Event	Available only when the trigger source is set to manual, external, or GPIB. Selects the trigger event mode when search is carried out for the trigger event. Trigger Event Mode is selected from every sweep, every measurement point, or every segment.	TRIG:EVEN
	-Trigger Polarity[ ]	Available only when the trigger source is set to external. Sets the polarity (up & down) of the outer trigger signals.	TRIG:SLOP
	-Manual Trigger	Available only when the trigger source is set to manual. The trigger is done once.	TRIG

Menu References  
**Menu References**

**Trigger - Hold**

Menu Bar (Key)	Setup Toolbar	Function	GPIB Command
Trigger -Hold	Cannot access.	Same function as <b>Trigger - Trigger Setup - Hold</b> .	INIT:CONT

**Trigger - Single**

Menu Bar (Key)	Setup Toolbar	Function	GPIB Command
Trigger -Single	Cannot access.	Same function as <b>Trigger - Trigger Setup - Single</b> .	INIT

**Trigger - Continuous**

Menu Bar (Key)	Setup Toolbar	Function	GPIB Command
Trigger -Continuous	Cannot access.	Same function as <b>Trigger - Trigger Setup - Continuous</b> .	INIT:CONT



## Utility Menu

### Utility - Utility...

Menu Bar (Key)	Setup Toolbar	Function	GPIB Command
<b>Utility</b> -Utility ( Utility )	<b>Utility:</b>  -Equivalent Circuit Menu  -Material Option Menu  -Macros  -Visual Basic Editor  -Save Program  -Load Program	<p>Calls up the setup toolbar that sets the equivalent circuit analysis. For details see “Utility - Utility - Equivalent Circuit Menu” on page 412.</p> <p>Calls up the setup toolbar that sets the measurement mode and the measuring materials. Materials measurement is only possible when Option 002 (material measurement software) is installed in the E4991A. For details see “Utility - Utility - Material Option Menu” on page 413.</p> <p>Displays the dialog box that runs and saves the loaded Macro program (VBA program). Lists only the procedures in the standard module defined as Public type. For more on the macro program, refer to “Chapter 3 Using Macros” in the <i>Programming Manual</i>.</p> <p>Displays the editing screen for the programming function of the internal VBA (Visual Basic Applications) program.</p> <p>Calls up the dialog box to store all files of the VBA project (macro programs that have the extension .lcr).</p> <p>Calls up the dialog box to load the stored Macro program (with extension .lcr).</p>	PROG:CAT? PROG:NAME PROG:STAT  None  MMEM:STOR:MACR  MMEM:LOAD:MACR

Utility - Utility - Equivalent Circuit Menu

Menu Bar (Key)	Setup Toolbar	Function	GPIB Command
<b>Utility</b> -Utility ( <b>Utility</b> )	-Equivalent Circuit Menu  <b>Equivalent Circuit:</b> -Select Circuit[ ]  -R1  -C1  -L1  -C0  -Calculate Parameters  -Simulate Freq-Char  -Simulate Freq-Char to All Traces	Calls up the setup toolbar that selects the equivalent circuit model. For details see “Utility - Utility - Equivalent Circuit Menu - Select Circuit[ ]” on page 413.  Enters the parameter R1 for the equivalent circuit model A-E. Also, the equivalent parameter R1 calculated by the <b>Calculate Parameters</b> button is displayed.  Enters the parameter C1 for the equivalent circuit model A-E. Also, the equivalent parameter C1 calculated by the <b>Calculate Parameters</b> button is displayed.  Enters the parameter L1 for the equivalent circuit model A-E. Also, the equivalent parameter L1 calculated by the <b>Calculate Parameters</b> button is displayed.  Enters the parameter C0 for the equivalent circuit model A-E. Also, the equivalent parameter C0 calculated by the <b>Calculate Parameters</b> button is displayed.  Calculates the equivalent circuit parameters based on the measurement results and the selected equivalent circuit model. If the partial search function of the marker is set to On, the equivalent circuit parameters are calculated within that search area.  Simulates, for all active traces, the selected equivalent circuit model frequency characterization based on the equivalent circuit parameter entered or calculated by the <b>Calculate Parameters</b> button. The simulated results are stored into the memory trace and displayed on screen.  Simulates, for all traces, the selected equivalent circuit model frequency characterization based on the equivalent circuit parameter entered or calculated by the <b>Calculate Parameters</b> button. The simulated results are stored into the memory trace and displayed on screen.	CALC{1-5};DATA:EPAR  CALC{1-5};DATA:EPAR  CALC{1-5};DATA:EPAR  CALC{1-5};DATA:EPAR  CALC{1-5};EPAR  CALC{1-5};EPAR:SIM  None



Menu References  
Menu References

Menu Bar (Key)	Setup Toolbar	Function	GPIB Command
	-Outer Diameter	Available only when the measurement is Permeability. Enters the outer diameter of the magnetic material (material under test).	CALC:FORM:PAR:MAG

**Utility - Equivalent Circuit...**

Menu Bar (Key)	Setup Toolbar	Function	GPIB Command
Utility -Equivalent Circuit...	Equivalent Circuit:	Same as <b>Utility - Utility - Equivalent Circuit</b> Menu.	

**Utility - Material Option...**

Menu Bar (Key)	Setup Toolbar	Function	GPIB Command
Utility -Material Option...	Material:	Same as <b>Utility - Utility - Material Option</b> Menu.	

**Utility - VBA Macros...**

Menu Bar (Key)	Setup Toolbar	Function	GPIB Command
Utility -VBA Macros...	Cannot access.	Same as <b>Utility - Utility - Macros</b> .	PROG:CAT? PROG:NAME PROG:STAT

**Utility - Visual Basic Editor...**

Menu Bar (Key)	Setup Toolbar	Function	GPIB Command
Utility -Visual Basic Editor...	Cannot access.	Same as <b>Utility - Utility - Visual Basic Editor</b> .	None

**Utility - Save Program...**

Menu Bar (Key)	Setup Toolbar	Function	GPIB Command
Utility -Save Program...	Cannot access.	Same as <b>Utility - Utility - Save Program.</b>	MMEM:STOR:MACR

**Utility - Load Program...**

Menu Bar (Key)	Setup Toolbar	Function	GPIB Command
Utility -Load Program...	Cannot access.	Same as <b>Utility - Utility - Load Program.</b>	MMEM:LOAD:MACR

## Save/Recall Menu

### Save/Recall - Save/Recall...

Menu Bar (Key)	Setup Toolbar	Function	GPIB Command
<b>Save/Recall</b>			
<b>-Save/Recall..</b> ( Save/Recall )	<b>Save/Recall:</b>		
	-Save State	Calls up the dialog box to store the state file (with extension .sta). The state file can store the E4991A setting, calibration data arrays, calibration coefficient arrays, fixture compensation data arrays, fixture compensation coefficient arrays, user-defined calibration kit settings, user-defined fixture compensation kit settings, data arrays, and memory arrays.	MMEM:STOR
	-Save Data	Calls up the dialog box to store the E4991A's internal data arrays. To store internal data, it is necessary to indicate the file type and the content of the internal data. See Chapter 7, "Saving and Recalling Internal Data," on page 165 for storing internal data.	MMEM:STOR:TRAC:ASC MMEM:STOR:TRAC MMEM:STOR:TRAC:SEL{1-4} MMEM:STOR:CIT{1-3}
	-Save Graphics	Calls up the dialog box to store the current display in jpg format or BMP format.	MMEM:STOR:GRAP
	-Recall State	Calls up the dialog box to load the stored state file (with extension .sta).	MMEM:LOAD
	-Recall Data	Calls up the dialog box to load the binary file (with extension .dat) where the internal data array is stored.	MMEM:LOAD:TRAC
	-xxx*1	Up to 3 recent stored/loaded state files can be registered in the Save/Recall toolbar.	

\*1. The absolute path of the recently stored/loaded file is displayed.

### Save/Recall - Save State...

Menu Bar (Key)	Setup Toolbar	Function	GPIB Command
<b>Save/Recall</b>			
<b>-Save State...</b>	Cannot access.	Same as <b>Save/Recall - Save/Recall - Save State.</b>	MMEM:STOR

**Save/Recall - Save Data...**

Menu Bar (Key)	Setup Toolbar	Function	GPIB Command
Save/Recall -Save Data...	Cannot access.	Same as <b>Save/Recall - Save/Recall - Save Data.</b>	MMEM:STOR:TRAC:ASC MMEM:STOR:TRAC MMEM:STOR:TRAC:SEL{1-4} MMEM:STOR:CIT{1-3}

**Save/Recall - Save Graphics...**

Menu Bar (Key)	Setup Toolbar	Function	GPIB Command
Save/Recall -Save Graphics...	Cannot access.	Same as <b>Save/Recall - Save/Recall - Save Graphics.</b>	MMEM:STOR:GRAP

**Save/Recall - Recall State...**

Menu Bar (Key)	Setup Toolbar	Function	GPIB Command
Save/Recall -Recall State...	Cannot access.	Same as <b>Save/Recall - Save/Recall - Recall State.</b>	MMEM:LOAD

**Save/Recall - Recall Data...**

Menu Bar (Key)	Setup Toolbar	Function	GPIB Command
Save/Recall -Recall Data...	Cannot access.	Same as <b>Save/Recall - Save/Recall - Recall Data.</b>	MMEM:LOAD:TRAC

## System Menu

### System - Toolbar Off

Menu Bar (Key)	Setup Toolbar	Function	GPIB Command
<b>System</b> <b>-Toolbar Off</b> ( <u>Cancel/Close</u> )	Cannot access.	Closes the setup toolbar. Dialog boxes can be closed with the <b>Cancel/Close</b> key.	None

### System - System...

Menu Bar (Key)	Setup Toolbar	Function	GPIB Command
<b>System</b> <b>-System...</b> ( <u>System</u> )	<b>System:</b>  -GPIB Setup Menu  -FTP Server Menu  -Remote Setup Dialog  -Beep[ ]  -About E4991A	Calls up the setup toolbar that sets the GPIB system control mode and address.  Calls up the setup toolbar that sets file transfer via FTP (File Transfer Protocol).  Available only when the remote user interface is On. Calls up the dialog box for connecting the remote user interface.  Sets the beep function [On/Off] that notifies the calibration measurement or Pass/Fail of the limit test function.  Displays the E4991A's product information (firmware version no. and installed option no.).	None   SYST:BEEP:STAT  *IDN? *OPT?



**System - System - GPIB Setup Menu**

Menu Bar (Key)	Setup Toolbar	Function	GPIB Command
<b>System</b> -System... ( <b>System</b> )	-GPIB Setup  <b>GPIB Setup:</b> -Control Mode[ ]  -E4991A Address  -Controller Address	Selects whether the E4991A or an external controller controls the GPIB bus; that is, it sets the GPIB control rights. Selection is made between the mode in which the E4991A is controlled by an outer controller (Addressable Only) and the mode in which the E4991A itself maintains control as a system controller (System Controller). After changing this setting, the system must be restarted.  Sets the E4991A GPIB address when the control mode is set to control by an external controller (Addressable Only).  Sets the controller GPIB address when the control mode is set to control by the E4991A itself (System Controller).	None   None  None

**System - System - FTP Server Menu**

Menu Bar (Key)	Setup Toolbar	Function	GPIB Command
<b>System</b> -System... ( <b>System</b> )	-FTP Server  <b>FTP Server:</b> -FTP Server[ ]  -Abort  -Disconnect	Switches On/Off the file transfer function via FTP (File Transfer Protocol). When On, a file stored in the E4991A hard disk can be transferred interactively to an external computer without using floppy discs.  Halts the FTP file transfer.  Disconnects the file transfer application from the external computer side.	None   None  None

Menu References  
Menu References

**System - Preset**

Menu Bar (Key)	Setup Toolbar	Function	GPIB Command
<b>System</b> -Preset ( <input type="button" value="Preset"/> )	Cannot access.	Returns the E4991A to its initial settings. For more on initial settings, refer to Appendix G, "Initial Settings," on page 439.	SYST:PRES

**System - Exit**

Menu Bar (Key)	Setup Toolbar	Function	GPIB Command
<b>System</b> -Exit	Cannot access.	Exits the E4991A system program and displays a Windows 98 desktop. To exit, a password entry is required. This operation is necessary for such purposes as installing printer drivers and setting the remote user interface addresses or internal clocks.	None

**System - GPIB Setup...**

Menu Bar (Key)	Setup Toolbar	Function	GPIB Command
<b>System</b> -GPIB Setup..	Cannot access.	Same function as <b>System - System - GPIB Setup</b> Menu.	None

**System - FTP Server Setup...**

Menu Bar (Key)	Setup Toolbar	Function	GPIB Command
<b>System</b> -FTP Server Setup...	Cannot access.	Same function as <b>System - System - FTP Server</b> Menu.	None

**System - Remote Setup...**

Menu Bar (Key)	Setup Toolbar	Function	GPIB Command
System -Remote Setup...	Cannot access.	Same function as <b>System - System - Remote Setup Dialog.</b>	None

**System - About E4991A...**

Menu Bar (Key)	Setup Toolbar	Function	GPIB Command
System -About E4991A...	Cannot access.	Same function as <b>System - System - About E4991A.</b>	*IDN? *OPT?

**System - Diagnostic...**

Menu Bar (Key)	Setup Toolbar	Function	GPIB Command
System -Diagnostic...	Cannot access.	Calls up the dialog box for the test function to diagnose the E4991A internal functions. For more on the test function, refer to the <i>Service Manual</i> .	*IDN? *OPT?

Menu References  
**Menu References**

---

## **E Theory on Material Measurement**

This appendix explains the basic principle and concept of material measurement.

## Dielectric Material Measurement

If your E4991A has Option 002 installed, it is possible to measure the relative permittivity of a solid dielectric material taking the shape of a board. Permittivity here refers to the ease of storing energy in an electric field.

### Definition of Permittivity

The application of an alternating-current electric field to a dielectric material causes some dielectric loss and a delay in the dielectric response to the electric field. Permittivity in an alternating-current electric field is defined as complex relative permittivity ( $\epsilon_r^*$ ) (see Equation E-1). The real component of complex relative permittivity ( $\epsilon_r'$ ) represents the amount of energy stored in the dielectric material from the alternating current electric field. On the other hand, the imaginary component ( $\epsilon_r''$ ) indicates energy loss to the alternating current electric field.

#### Equation E-1

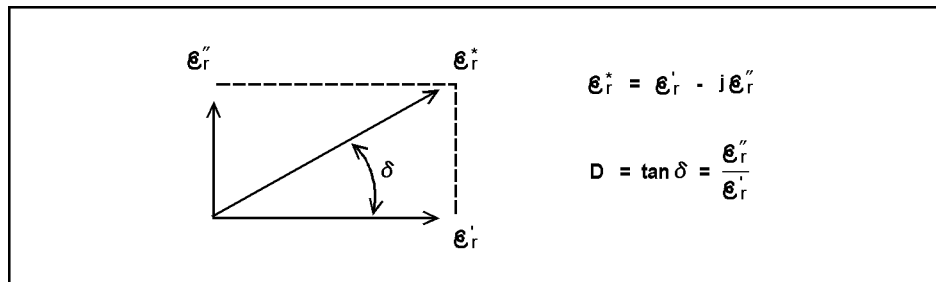
#### Definition of Complex Relative Permittivity

$$\epsilon_r^* = \epsilon_r' - j\epsilon_r''$$

As shown in Figure E-1, complex relative permittivity can be expressed in a vector diagram. The dielectric loss factor (D) of a dielectric material is expressed as a dielectric loss tangent ( $\tan\delta$ ), which is the ratio of the imaginary component ( $\epsilon_r''$ ) to the real component ( $\epsilon_r'$ ) of complex relative permittivity.

Figure E-1

#### Vector Diagram of Complex Relative Permittivity and Dielectric Loss Tangent



e4991a0j506

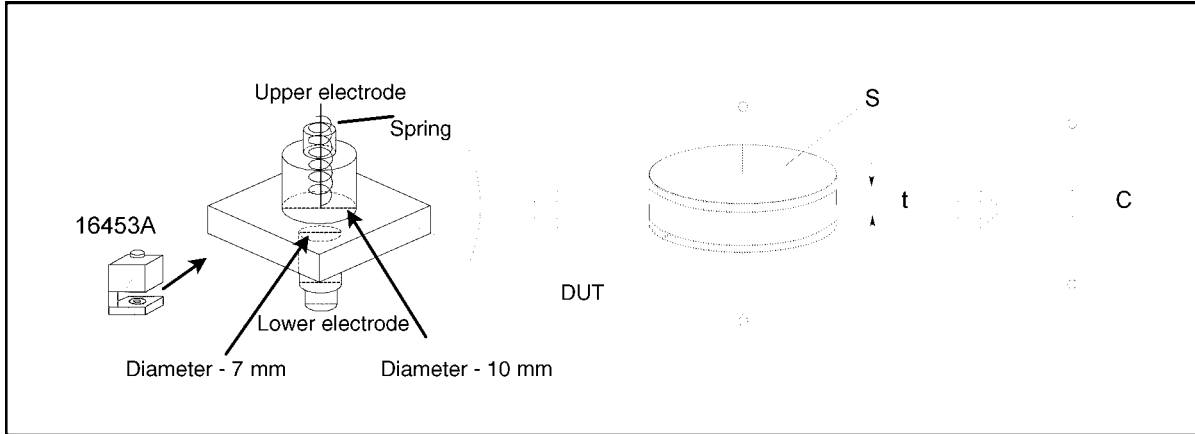
#### NOTE

Dielectric material measurement generally implies the measurement of its relative permittivity.

## Measurement Principle of Dielectric Material

The E4991A uses the measurement technology called the Capacitance Method to measure relative permittivity. This method calculates relative permittivity from capacitance values measured with the E4991A by positioning a DUT between the test fixture's electrodes to form a condenser. Figure E-2 shows a conceptual diagram using a 16453A test fixture.

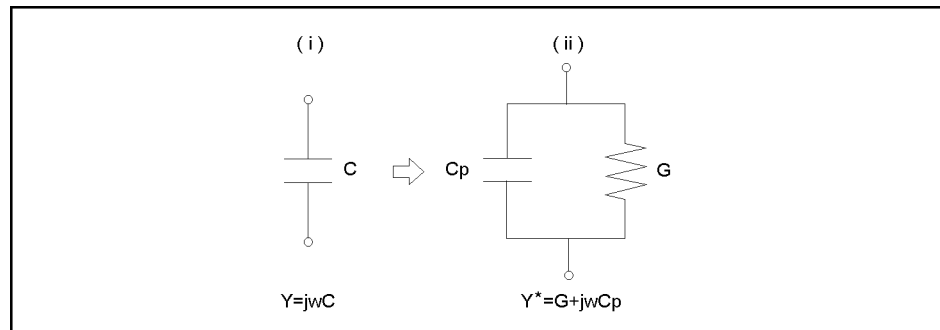
**Figure E-2** Capacitance Method



e4991a0e503

Since the capacitor  $C$  (see Figure E-2) formed using 16453A has a small capacity because of its large impedance, the equivalent circuit in Figure E-3 consists of an equivalent parallel capacitance and an equivalent parallel conductance.

**Figure E-3** Loss of Dielectric Material



e4991a0j505

The admittance  $Y$  of the circuit (i) in Figure E-3 is expressed as Equation E-2, and the complex admittance ( $Y^*$ ) of the circuit (ii) is expressed as Equation E-3.  $C_0$  indicates a capacitance when using air as a dielectric material.

**Equation E-2** Admittance of Circuit (i)

$$Y = j\omega C = j\omega |\epsilon_r^*| C_0$$

**Equation E-3** Complex Admittance of Circuit (ii)

$$Y^* = G + j\omega C_p = j\omega \left( \frac{C_p}{C_0} - j \frac{G}{\omega C_0} \right) C_0$$

Therefore, the complex relative permittivity of a dielectric material ( $\epsilon_r^*$ ) and the real ( $\epsilon_r'$ ) and imaginary ( $\epsilon_r''$ ) components of the complex relative permittivity are calculated as follows.

**Equation E-4**      **Calculation of Complex Relative Permittivity ( $\epsilon_r^*$ )**

$$\epsilon_r^* = \left( \frac{C_p}{C_0} - j \frac{G}{\omega C_0} \right)$$

**Equation E-5**      **Calculation of Effective Relative Permittivity ( $\epsilon_r'$ )**

$$\epsilon_r' = \frac{C_p}{C_0} = \frac{tC_p}{\epsilon_0 S}$$

**Equation E-6**      **Calculation of Relative Permittivity Loss ( $\epsilon_r''$ )**

$$\epsilon_r'' = \frac{G}{\omega C_0} = \frac{t}{\omega \epsilon_0 S R_p} \quad \left( G \rightarrow \frac{1}{R_p} \right)$$

**NOTE**

The electrode area  $S$  of the 16453A test fixture is included in the calculation as the area of the lower electrode.

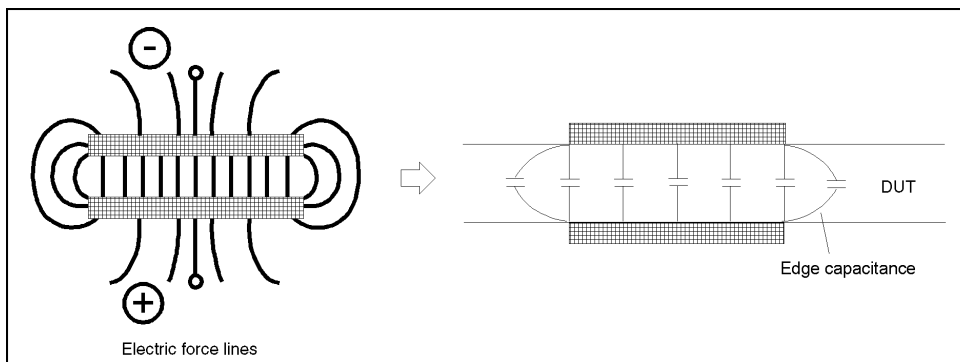
**Error Components of 16453A Test Fixture**

Error components of the 16453A test fixture include errors due to edge capacitance on edge electrodes (stray capacitance), residual parameters of the test fixture such as electrical length, residual impedance, stray admittance, and an air gap caused when sandwiching the DUT between the electrodes.

**Error Due to Edge Capacitance**

Figure E-4 shows lines of electric force when measuring a capacity value of a dielectric material. As shown in Figure E-4, edge capacitance occurs around electrode edges, resulting in a larger capacitance value than it really has. The E4991A internally calculates edge capacitance, thus eliminating the need to consider errors due to edge capacitance when using the 16453A test fixture.

**Figure E-4**      **Occurrence of Edge Capacitance**



e4991ace507



### Errors Due to Residual Parameters of Test Fixture

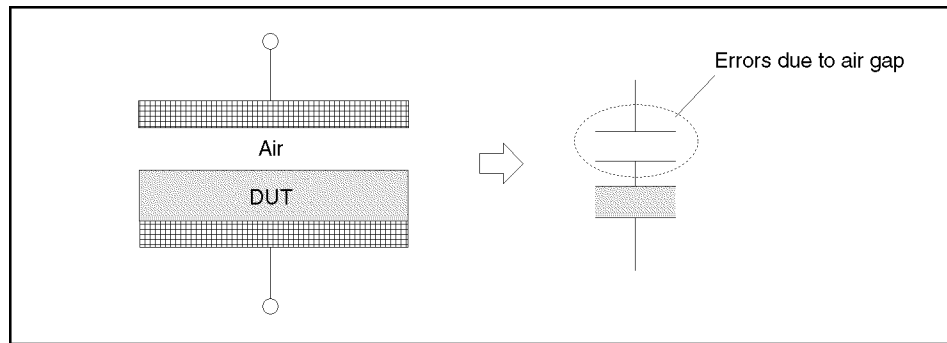
Since the 16453A test fixture has errors due to electrical length, residual impedance, and stray admittance, these errors can be minimized by performing OPEN, SHORT and LOAD calibrations on the DUT contact surface of the test fixture.

### Errors Due to Air Gap

The 16453A test fixture uses the Electrode Contact Method to sandwich a DUT between electrodes. In this method, even if the DUT is processed as flat as possible, an air gap is formed between the DUT and the electrodes, affecting the measured capacitance value as an error component.

Figure E-5

### Errors Due to Air Gap



e4991a0e509

There are several methods to minimize error due to air gap:

- Form thin film electrodes on a dielectric material.
- Maximize the spring pressure on the test fixture to the extent that it does not deform the DUT.
- When measuring a thin (several hundred  $\mu\text{m}$ ) and highly-pressure-resistant DUT with a smooth surface, lay three to four DUTs one on the top of the other.

If the first method is used, it is necessary to process the DUT into a shape suitable for the positioning of the electrodes formed on the DUT and the 16453A structure.

## Magnetic Material Measurement

If your E4991A has Option 002 installed, the relative permeability of a magnetic material (a toroidal core) can be measured. Permeability here refers to the ease of storing energy in the magnetic field.

### Definition of Permeability

The application of an alternating-current magnetic field to a magnetic material will cause some magnetic loss and delayed induction of magnetic flux. Permeability in the alternating-current magnetic field is defined as complex relative permeability ( $\mu_r^*$ ) (see Equation E-7). The real component of the complex relative permeability ( $\mu_r'$ ) represents the amount of energy stored in the magnetic material from the alternating-current magnetic field. On the other hand, the imaginary component ( $\mu_r''$ ) indicates energy loss to the alternating current magnetic field.

Equation E-7

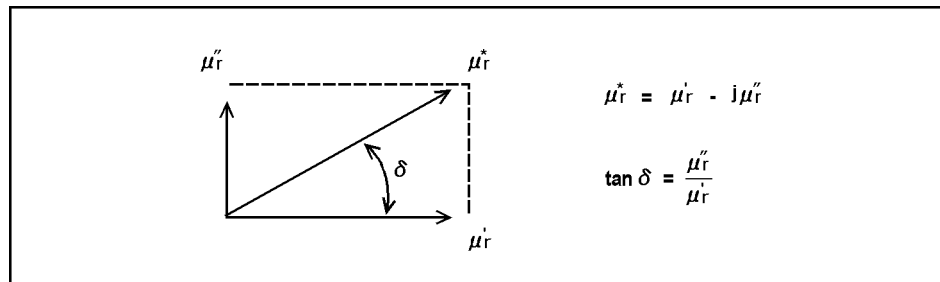
### Definition of Complex Relative Permeability

$$\mu_r^* = \mu_r' - j\mu_r''$$

As shown in Figure E-6, complex relative permeability can be expressed in a vector diagram. The loss factor (D) of a magnetic material is expressed as a loss tangent ( $\tan\delta$ ), which is the ratio of the imaginary component ( $\mu_r''$ ) to the real component ( $\mu_r'$ ) of the complex relative permeability.

Figure E-6

### Vector Diagram of Complex Relative Permeability and Loss Tangent



e4991a0j512

### NOTE

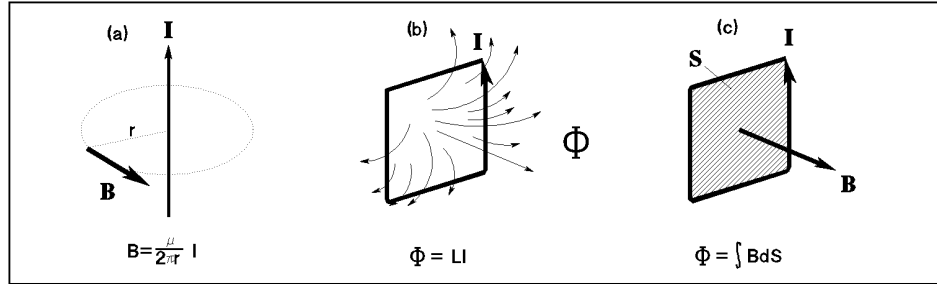
Magnetic material measurement generally implies the measurement of its relative permeability.

### Measurement Principle of Magnetic Material

To measure relative permeability, the E4991A uses a measurement technology called the Inductance Method. In this method, a DUT (toroidal core) is wrapped with a wire, and relative permeability is calculated from the inductance values at the end of the core. This section explains the measurement principle when using the 16454A test fixture.

Figure E-7

#### Relationship among Current, Magnetic Flux, and Magnetic Flux Density



Generally, the magnetic flux density (  $B$  ) induced by the current running in a line of unlimited length, as shown in (a) of Figure E-7, is expressed as Equation E-8.

Equation E-8

#### Magnetic Flux Density Induced by Current Running in Line of Unlimited Length

$$B = \frac{\mu I}{2\pi r}$$

On the other hand, the magnetic flux (  $\Phi$  ) induced by current running in the closed loop shown in (b) of Figure E-7 is expressed as Equation E-9. Note that  $L$  indicates the self-inductance of the closed loop.

Equation E-9

#### Magnetic Flux Induced by Current in Closed Loop

$$\Phi = LI$$

Furthermore, this magnetic flux (  $\Phi$  ) also can be expressed as the integration of magnetic flux density (  $B$  ) with respect to area, as shown in Figure E-7 (See Equation E-10).

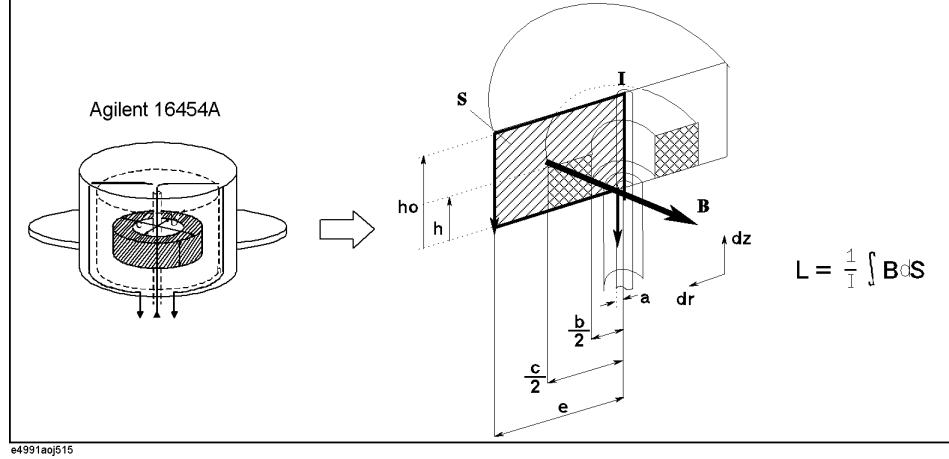
Equation E-10

#### Relationship between Magnetic Flux and Magnetic Flux Density

$$\Phi = \int B ds$$

When a DUT (toroidal core) is mounted in a 16454A, an ideal (no magnetic flux leak) inductance with a wire rolled once is formed, as shown in Figure E-8.

**Figure E-8 Measurement Principle When Using 16454A Test Fixture**



The self-inductance of a measurement circuit including the DUT is derived as Equation E-11 from Equation E-8, Equation E-9, Equation E-10, and the physical shape of the 16454A.

**Equation E-11 Self-Inductance of Measurement Circuit**

$$L = \frac{1}{I} \int B ds = \int_a^e \int_0^{h_0} \frac{\mu}{2\pi r} dr dz$$

By unfolding Equation E-11 with  $\mu_0$  as permeability of free space and  $\mu_r$  as relative permeability of the DUT, Equation E-12 can be obtained.

**Equation E-12 Self-Inductance of Measurement Circuit**

$$L = \int_{\frac{c}{2}}^e \int_0^{h_0} \frac{\mu_0}{2\pi r} dr dz + \int_{\frac{b}{2}}^{\frac{c}{2}} \int_0^h \frac{\mu_0 \mu_r}{2\pi r} dr dz + \int_{\frac{b}{2}}^{\frac{c}{2}} \int_h^{h_0} \frac{\mu_0}{2\pi r} dr dz + \int_a^{\frac{b}{2}} \int_0^{h_0} \frac{\mu_0}{2\pi r} dr dz$$

By further unfolding Equation E-12, Equation E-13 can be obtained.

**Equation E-13 Self-Inductance of Measurement Circuit**

$$L = \frac{\mu_0}{2\pi} \left\{ (\mu_r - 1) h \ln \frac{c}{b} + h_0 \ln \frac{e}{a} \right\}$$

By transforming Equation E-13 to calculate the relative permeability ( $\mu_r$ ) of the DUT, Equation E-14 can be obtained.

**Equation E-14 Relative Permeability of DUT**

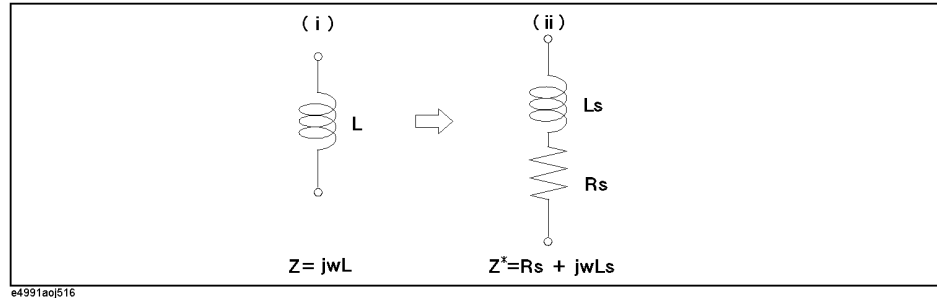
$$\mu_r = \frac{2\pi(L - L_{ss})}{\mu_0 h \ln \frac{c}{b}} + 1$$

$L_{ss}$  in Equation E-15 indicates self-inductance when a DUT is not mounted in the test fixture.

**Equation E-15 Self-Inductance When DUT Is Not Mounted in Test Fixture**

$$L_{ss} = \frac{\mu_0}{2\pi} h_0 \ln \frac{e}{a}$$

**Figure E-9 Loss of Magnetic Material**



The impedance  $Z$  of the circuit (i) in Figure E-9 is expressed as Equation E-16, and the complex impedance  $Z^*$  of the circuit (ii) is expressed as Equation E-17.

**Equation E-16 Impedance of Circuit (i)**

$$Z = j\omega L$$

**Equation E-17 Complex Impedance of Circuit (ii)**

$$Z^* = R_s + j\omega L_s = j\omega \left( \frac{R_s}{j\omega} + L_s \right)$$

As alternating current causes inductance loss, the self-inductance  $L$  of the measurement circuit is expressed as complex impedance, as shown in Equation E-18.

**Equation E-18 Self-Inductance of Measurement Circuit Expressed as Complex Impedance**

$$L = \frac{Z^*}{j\omega}$$

Substituting “L” in Equation E-18 into Equation E-14 yields Equation E-19.

**Equation E-19 Complex Relative Permeability of DUT**

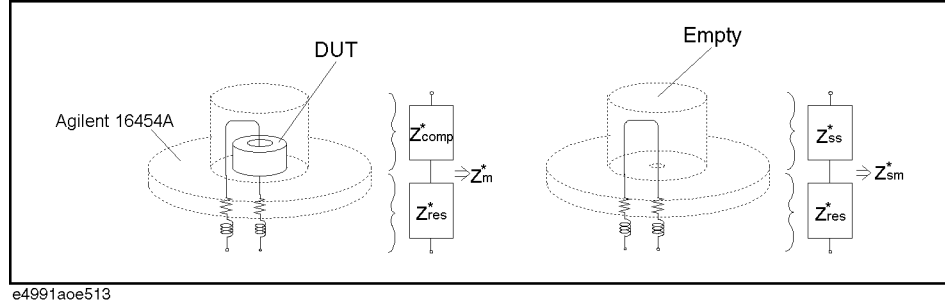
$$\mu_r^* = \frac{2\pi(Z^* - j\omega L_{ss})}{j\omega\mu_0 h \ln \frac{e}{b}} + 1$$

### Structure of 16454A Test Fixture

As shown in Figure E-10, 16454A has a residual impedance  $Z_{res}^*$  as serial impedance.

Figure E-10

#### 16454A Residual Impedance



Given the ideal impedance  $Z_{ss}^*$  of the 16454A test fixture with no DUT mounted, the residual impedance  $Z_{res}^*$  can be calculated from the measured impedance  $Z_{sm}^*$  with no DUT mounted in the 16454A (in SHORT state).

Equation E-20

#### 16454A Residual Impedance

$$Z_{res}^* = Z_{sm}^* - Z_{ss}^*$$

Errors due to residual impedance can be minimized by SHORT compensation. The impedance after error compensation  $Z_{comp}^*$  can be calculated from the measured impedance  $Z_m^*$  with a DUT mounted in the 16454A, as shown in Equation E-21.

Equation E-21

#### Compensated Impedance

$$Z_{comp}^* = Z_m^* - Z_{res}^*$$

Assuming that  $Z_{ss}^*$  consists only of inductance elements ( $Z_{ss}^* = j\omega L_{ss}$ ), the complex relative permeability of the DUT can be calculated using Equation E-19 and compensated impedance,  $Z_{comp}^* (=Z^*)$ , as shown in Equation E-22.

Equation E-22

#### Complex Permeability of DUT

$$\mu_r^* = \frac{2\pi(Z_m^* - Z_{sm}^*)}{j\omega\mu_0 h \ln \frac{c}{b}} + 1$$

---

## **F** Information on Maintenance

This appendix explains the measures you should take to maintain the Agilent E4991A.

---

## Cleaning this Instrument

This section describes how to clean the instrument.

---

### WARNING

**To protect yourself from electrical shock, be sure to unplug the power cable from the outlet before cleaning the instrument.**

**Never clean the internal components of the instrument.**

---

### Cleaning an LCD

Use one of the following methods to clean the display surface regularly.

- For normal cleaning, wipe the surface gently with a soft cloth that is dry or wetted with a small amount of water and wrung tightly.
- When stains are difficult to remove, gently wipe the surface with cloth dampened with a small amount of ethanol or isopropyl alcohol.

---

### NOTE

Do not use chemicals other than ethanol and isopropyl alcohol to wet the cleaning cloth.

### Maintenance of Connectors/Ports

A 7-mm connector is used for the test head of the E4991A. The N-type connector is used for the front panel. In the RF band, dirt or damage to connectors significantly affects measurement accuracy. Take special care about the following.

- Always keep the connectors free from stains and dust.
- Do not touch the contact surface on the connectors.
- Do not plug damaged or scratched connectors into the test ports.
- Use compressed air for cleaning connectors. Do not use abrasives under any circumstance.

Observe the above instruction for the connectors and ports not on the test head or the front panel.

### Procedure to replace center conductor collet of 7-mm connector.

#### Required tools

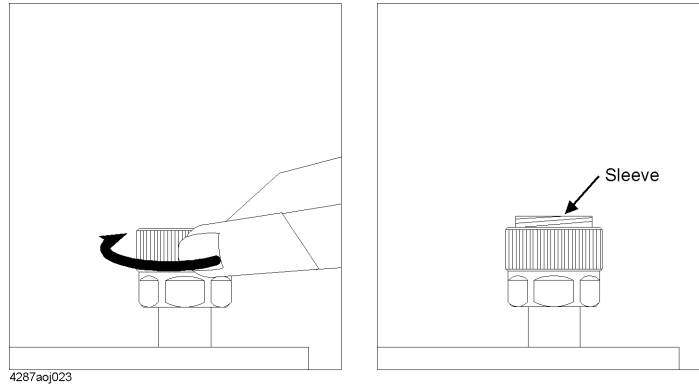
	Agilent part number
Collet removal tool	5060-0370
6-slot precision collet	85050-20001



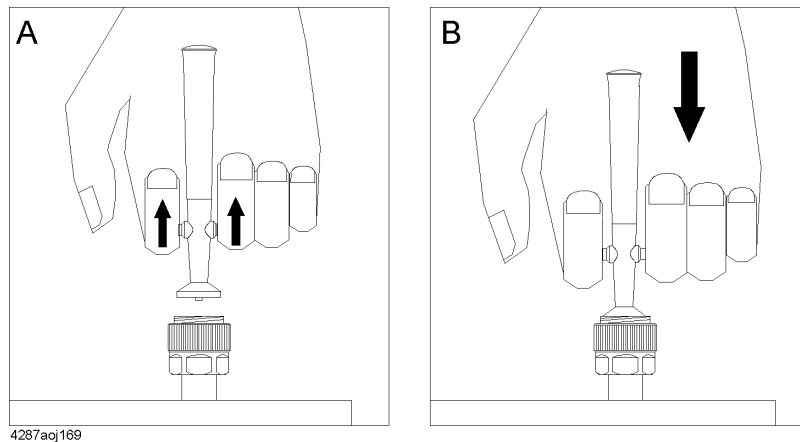
### Removing center conductor collet

Follow these steps to remove the center conductor collet of the 7-mm connector.

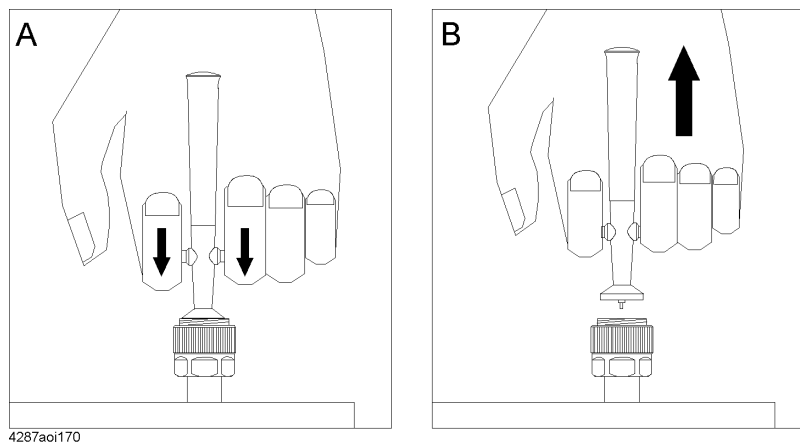
- Step 1.** Turn the outer part of the 7-mm connector clockwise viewed from above to completely expose the connector sleeve.



- Step 2.** Pull up the handle of the collet replacement tool (Figure A below) and, while keeping pulling the handle, insert the replacement tool slowly until it touches the end of the connector (Figure B below).



- Step 3.** After releasing the handle (Figure A below), pull up the collet removal tool (Figure B below) to remove the old collet.

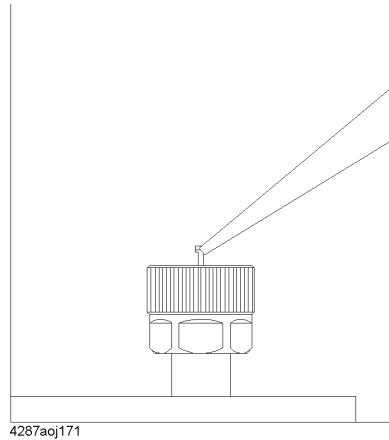


Information on Maintenance  
**Cleaning this Instrument**

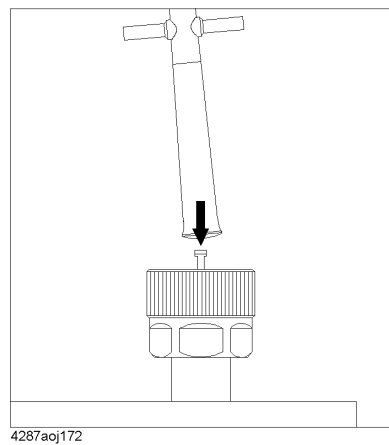
**Installing center conductor collet**

Follow these steps to install the center conductor collet of the 7-mm connector.

**Step 1.** Insert the collet into the center conductor of the connector.



**Step 2.** Push the collet slowly as far as it will go.



**Cleaning a Display Other than an LCD**

To remove stains on parts other than the LCD, test ports, and other connectors/ports of the instrument, wipe them gently with a soft cloth that is dry or wetted with a small amount of water and wrung tightly.

## **Cautions Applicable to Requesting Repair, Replacement, Regular Calibration, etc.**

### **Devices to be Sent Back for Repair or Regular Calibration**

If it is necessary to send the unit to the Service Center of Agilent Technologies for repair or regular calibration, please follow the instructions below.

#### **Devices you must send**

When you ask our service center for repair or periodic calibration of the instrument, send the E4991A with the following accessories attached. No other accessories have to be sent.

- o Test head
- o Calibration kit

For Option 010, send the following accessories in addition to the above.

- o Option 010 test head (with extension cable)
- o N (male) - SMA (female) conversion adapter (x 3)

For Option 007, send the following accessories in addition to the above.

- o Measurement cable (heat-resistant)
- o Extension cable
- o N (male) - SMA (female) conversion adapter (x 3)
- o N (female) - SMA (female) conversion adapter (x 3)

#### **Packing**

Use the original package and shock absorbers, or equivalent antistatic packing materials, when sending the unit.

#### **Shipping Address**

For the location of the nearest Agilent Technologies Service Center, contact the Customer Contact listed at the end of this brochure.

### **Recommended Calibration Period**

The recommended calibration period for this instrument is one year. The user is recommended to request the Company's Service Center to perform regular calibration every year.

Information on Maintenance

**Cautions Applicable to Requesting Repair, Replacement, Regular Calibration, etc.**

---

## **G** Initial Settings

This appendix lists initial settings, settings that can be saved/recalled, and settings that can be backed up.

## **Initial Settings, Settings that can be Saved/Recalled, Settings that can be Backed Up**

The following table shows the following items.

- Initial settings (factory settings)
- Settings set by the **Preset** key on the front panel or reset by the **:SYST:PRES** GPIB command).
- Settings reset by the **\*RST** GPIB command.
- Settings that can be saved/recalled

The table uses the following symbols.

√: Settings that can be saved/recalled

blank: Settings that cannot be saved/recalled

- Settings that can be restored to calibration/compensation status by the **Recover Cal/Comp State** button

The table uses the following symbols.

√: Settings that can be saved/recalled

blank: Settings that cannot be saved/recalled

- Settings that can be backed up

The table uses the following symbols.

√: Settings that can be backed up

blank: Settings that cannot be backed up

- Available methods for making a setting

The table uses the following symbols.

L: Settings that can be set by the local user interface.

R: Settings that can be set by the remote user interface.

G: Settings that can be set by a remote controller using a GPIB command.

---

### **NOTE**

The symbol “←” in the table indicates that the value is the same as that indicated in the space to the left.

Initial Settings

**Initial Settings, Settings that can be Saved/Recalled, Settings that can be Backed Up**

Related key	Box/button name of toolbar or setting	Factory settings	Reset		Save/Recall	Restore cal/comp settings	Back up	Available setting methods
			Preset	*RST				
Trace	Active Trace	Trace 1	←	←	√			L/R/G
Meas/Format	Meas Parameter	Trace 1:  Z  Trace 2: $\theta z$ [°]	←	←	√			L/R/G
	Format	Z : Lin Y-Axis $\theta z$ : Lin Y-Axis	←	←	√			L/R/G
	Expand Phase	Off	←	←	√			L/R/G
	Phase Unit	Degree	←	←	√			L/R/G
	Sweep Average	Off	←	←	√			L/R/G
	Swp Avg Count	16	←	←	√			L/R/G
Scale	Full Scale	Z : 1 M $\Omega$ $\theta z$ : 400 °	←	←	√			L/R/G
	Ref Val	Z : 500 k $\Omega$ $\theta z$ : 0 °	←	←	√			L/R/G
	Ref Pos	5	←	←	√			L/R/G
	Scale For	Data	←	←	√			L/R/G
	Scale Entry	Scale/Ref	←	←	√			L/R/G
	Reference Line	On	←	←	√			L/R/G

## Initial Settings

### Initial Settings, Settings that can be Saved/Recalled, Settings that can be Backed Up

Related key	Box/button name of toolbar or setting	Factory settings	Reset		Save/Recall	Restore cal/comp settings	Back up	Available setting methods
			Presets	*RST				
Display	Number Of Traces	2 Scalar	←	←	√			L/R/G
	Display Scalar Trace	Overlay	←	←	√			L/R/G
	Define Trace	Data	←	←	√			L/R/G
	Math Offset	0	←	←	√			L/R/G
	List Values	Off	←	←	√			L/R/G
	E4991A default local printer (driver name)	HP DeskJet 550C Printer	No effect	No effect			√	L/G
	Scalar 1 Data (color setting)	R:255, G:255, B:0	←	←	√			L/R/G
	Scalar 1 Mem (color setting)	R:0, G:255, B: 0	←	←	√			L/R/G
	Scalar 2 Data (color setting)	R:0, G:255, B:255	←	←	√			L/R/G
	Scalar 2 Mem (color setting)	R:255, G:0, B:0	←	←	√			L/R/G
	Scalar 3 Data (color setting)	R:255, G:0, B:255	←	←	√			L/R/G
	Scalar 3 Mem (color setting)	R:0, G:0, B:255	←	←	√			L/R/G
	Complex 1 Data (color setting)	R:255, G:255, B: 0	←	←	√			L/R/G
	Complex 1 Mem (color setting)	R:0, G:255, B:0	←	←	√			L/R/G
	Complex 2 Data (color setting)	R:0, G:255, B:255	←	←	√			L/R/G
	Complex 2 Mem (color setting)	R:255, G:0, B:0	←	←	√			L/R/G
	Background (color setting)	R:0, G:0, B:0	←	←	√			L/R/G
	Grid (color setting)	R:128, G:128, B:128	←	←	√			L/R/G
Freq Disp Resolution	10 kHz	←	←	√			L/R/G	



Initial Settings

**Initial Settings, Settings that can be Saved/Recalled, Settings that can be Backed Up**

Related key	Box/button name of toolbar or setting	Factory settings	Reset		Save/Recall	Restore cal/comp settings	Back up	Available setting methods
			Preset	*RST				
<b>Marker</b>	Marker On/Off	All Off (Marker 1 is on immediately after the marker toolbar is displayed)	←	←	√			L/R/G
	Select Marker	Marker 1 (immediately after the maker toolbar is displayed)	←	←	√			L/R/G
	Stimulus	Marker 1: 1.5005 GHz (immediately after the maker toolbar is displayed)	←	←	√			L/R/G
	Marker On	Data	←	←	√			L/R/G
	Delta Mode	Off	←	←	√			L/R/G
	Marker (Continuous/Dicrete)	Continuous	←	←	√			L/R/G
	Marker Couple	On	←	←	√			L/R/G
<b>Marker Fctn</b>	Search Type	Maximum	←	←	√			L/R/G
	Search Track	Off	←	←	√			L/R/G
	Partial Search	Off	←	←	√			L/R/G
	Target Value	0 Ω	←	←	√			L/R/G
	Peak Delta X	10 MHz	←	←	√			L/R/G
	Peak Delta Y	1 Ω	←	←	√			L/R/G
	Marker List	Off	←	←	√			L/R/G
	Statistics	Off	←	←	√			L/R/G
	Smith/Polar (maker display parameter)	Real Imag	←	←	√			L/R/G
	Marker X Axis	Stimulus	←	←	√			L/R/G
	Limit Test	Off	←	←	√			L/R/G
	Test Marker	All Off	←	←	√			L/R/G
	Upper (maker limit test upper limit value)	All 0 (immediately after the test marker is set on)	←	←	√			L/R/G
	Lower (maker limit test lower limit value)	All 0 (immediately after the test marker is set on)	←	←	√			L/R/G

## Initial Settings

### Initial Settings, Settings that can be Saved/Recalled, Settings that can be Backed Up

Related key	Box/button name of toolbar or setting	Factory settings	Reset		Save/Recall	Restore cal/comp settings	Back up	Available setting methods
			Preset	*RST				
Start/Stop	Start	1 MHz	←	←	√	√		L/R/G
	Stop	3 GHz	←	←	√	√		L/R/G
	Center	1.5005 GHz	←	←	√	√		L/R/G
	Span	2.999 GHz	←	←	√	√		L/R/G
	Stimulus Display	Start/Stop	←	←	√			L/R/G
Sweep	Number Of Points	201	←	←	√	√		L/R/G
	Point Averaging	1	←	←	√	√		L/R/G
	Sweep Time	Auto	←	←	√	√		L/R/G
	Sweep Parameter	Frequency	←	←	√	√		L/R/G
	Sweep Type	Linear	←	←	√	√		L/R/G
	Sweep Direction	Up	←	←	√	√		L/R/G
	Start (segment sweep)	1 MHz (first added segment)	←	←	√	√		L/R/G
	Stop (segment sweep)	3 GHz (first added segment)	←	←	√	√		L/R/G
	Number Of Points (segment sweep)	2 (first added segment)	←	←	√	√		L/R/G
	Point Average (segment sweep)	1 (first added segment)	←	←	√	√		L/R/G
	Osc Level (segment sweep)	100 mV (first added segment)	←	←	√	√		L/R/G
	Osc Unit (segment sweep)	Voltage (first added segment)	←	←	√	√		L/R/G
	Bias Level (segment sweep)	100 $\mu$ A (first added segment)	←	←	√	√		L/R/G
	Bias Limit (segment sweep)	1 V (first added segment)	←	←	√	√		L/R/G
	Bias Source (segment sweep)	Current (first added segment)	←	←	√	√		L/R/G
Segment Display	Freq Base	←	←	√			L/R/G	

**Initial Settings, Settings that can be Saved/Recalled, Settings that can be Backed Up**

Related key	Box/button name of toolbar or setting	Factory settings	Reset		Save/Recall	Restore cal/comp settings	Back up	Available setting methods
			Preset	*RST				
Source	Osc Level	100.0 mV (Voltage)	←	←	√	√		L/R/G
	Osc Unit	Voltage	←	←	√	√		L/R/G
	CW Freq	1 MHz	←	←	√	√		L/R/G
	Bias Level	100 $\mu$ A (current source) 0 V (voltage source)	←	←	√	√		L/R/G
	Bias Limit	1 V (current source) 2 mA (voltage source)	←	←	√	√		L/R/G
	Bias Source	Current	←	←	√	√		L/R/G
	Bias Monitor	Off	←	←	√	√		L/R/G
	Dc Bias	Off	←	←	√	√		L/R/G

## Initial Settings

### Initial Settings, Settings that can be Saved/Recalled, Settings that can be Backed Up

Related key	Box/button name of toolbar or setting	Factory settings	Reset		Save/Recall	Restore cal/comp settings	Back up	Available setting methods
			Preset	*RST				
Cal/ Compen	Cal Menu (calibration status)	Uncal	← *1	← *1	√	√		L/R/G
	Cal Type	Fixed Freq & Pwr	←	←	√	√		L/R/G
	Comp Menu (compensation status)	Off	←	←	√	√		L/R/G
	Cal Kit Type (7 mm / User /PTFE)	7 mm (when the Material Type is set to Permeability: PTFE)	←	←	√	√		L/R/G
	Open G (calibration kit)	0 S (when the Cal Kit Type is set to User)	←	←	√	√		L/R/G
	Open C (calibration kit)	0 F (when the Cal Kit Type is set to User)	←	←	√	√		L/R/G
	Short R (calibration kit)	0 Ω (when the Cal Kit Type is set to User)	←	←	√	√		L/R/G
	Short L (calibration kit)	0 H (when the Cal Kit Type is set to User)	←	←	√	√		L/R/G
	Load R (calibration kit)	50 Ω (when the Cal Kit Type is set to User)	←	←	√	√		L/R/G
	Load L (calibration kit)	0 H (when the Cal Kit Type is set to User)	←	←	√	√		L/R/G
	er Real (calibration kit)	2.1 (when the Material Type is set to Permeability)	No effect	←	√	√		L/R/G
	er Loss (calibration kit)	0 (when the Material Type is set to Permeability)	No effect	←	√	√		L/R/G
	Thickness (calibration kit)	800 μ (when the Material Type is set to Permeability)	No effect	←	√	√		L/R/G
	Open G (compensation kit)	0 S	←	←	√	√		L/R/G
	Open C (compensation kit)	0 F	←	←	√	√		L/R/G
	Short R (compensation kit)	0 Ω	←	←	√	√		L/R/G
	Short L (compensation kit)	0 H	←	←	√	√		L/R/G
	Fixture Type	None	←	←	√	√		L/R/G
	Fixture Length	0 m	←	←	√	√		L/R/G
	Port Extension	0 sec	←	←	√	√		L/R/G

Initial Settings

**Initial Settings, Settings that can be Saved/Recalled, Settings that can be Backed Up**

Related key	Box/button name of toolbar or setting	Factory settings	Reset		Save/Recall	Restore cal/comp settings	Back up	Available setting methods
			Preset	*RST				
Trigger Setup	Hold/Single/Continuous (trigger mode)	Continuous	←	←	√	√		L/R/G
	Trigger Source	Internal	←	←	√	√		L/R/G
	Trigger Event	On Sweep (immediately after the Trigger Source is set, except to internal)	←	←	√	√		L/R/G
	Trigger Polarity	Positive (immediately after the Trigger Source is set to External)	←	←	√	√		L/R/G
	Trigger system continuous activation On/Off (Init:cont)	On	←	Off	√	√		G
Utility	Select Circuit (equivalent circuit selection)	A	←	←	√			L/R/G
	R1 (equivalent circuit parameter)	0 Ω	←	←	√			L/R/G
	C1 (equivalent circuit parameter)	0 F	←	←	√			L/R/G
	L1 (equivalent circuit parameter)	0 H	←	←	√			L/R/G
	C0 (equivalent circuit parameter)	0 F	←	←	√			L/R/G
	Material Type	Impedance	←	←	√	√		L/R/G
	Thickness	1 μm (immediately after the Material Type is set to Permeability)	←	←	√	√		L/R/G
	Height	3.65 mm (immediately after the Material Type is set to Permeability)	←	←	√	√		L/R/G
	Inner Diameter	3.04 mm (immediately after the Material Type is set to Permeability)	←	←	√	√		L/R/G
	Outer Diameter	9 mm (immediately after the Material Type is set to Permeability)	←	←	√	√		L/R/G

## Initial Settings

### Initial Settings, Settings that can be Saved/Recalled, Settings that can be Backed Up

Related key	Box/button name of toolbar or setting	Factory settings	Reset		Save/Recall	Restore cal/comp settings	Back up	Available setting methods
			Presets	*RST				
System	Control Mode (GPIB)	Addressable only	No effect	←			√	L
	Address: E4991A (GPIB)	17	No effect	←			√	L
	Address: Controller (GPIB)	21	No effect	←			√	L
	Data transfer format	ASCII	No effect	ASCII				G
	Byte order when data transfer format is set to binary	NORMAL	No effect	NORMAL				G
	FTP Server	On	No effect	←			√	L
	Host Name (remote U/I)	localhost	No effect	←			√	R
	Port Number (remote U/I)	4991	No effect	←			√	R
	Time Interval (remote U/I)	5	No effect	←			√	R
	Beep	On	←	←	√	√		L/R/G
	Time and date of the internal clock	unspecified	No effect	←			√	L
	IP address	192.168.0.1	No effect	←			√	L
	Gateway address	-	No effect	←			√	L
	Subnet mask	255.255.255.0	No effect	←			√	L
	Computer name	E4991A	No effect	←			√	L
	Service request enable register number	0	No effect	←				G
	Standard event status enable register number	0	No effect	←				G
	Operation status register enable register number	0	No effect	←				G
	Operation status register positive transition filter number	32767	No effect	←				G
	Operation status register negative transition filter number	0	No effect	←				G
Questionable status enable register number	0	No effect	←				G	

**Initial Settings, Settings that can be Saved/Recalled, Settings that can be Backed Up**

Related key	Box/button name of toolbar or setting	Factory settings	Reset		Save/Recall	Restore cal/comp settings	Back up	Available setting methods
			Presets	*RST				
Save/Recall	E4991A current directory at state saving	D:\Documents	No effect	No effect			√	L/G
	File type of the data to be saved ( <b>ASCII/Binary</b> )	Binary	←	←	√			L/R/G
	Contents of the data to be saved ( <b>Contents</b> )	Trace Data, Trace Memory	←	←	√			L/R/G
	Format of the graphics to be saved ( <b>Format</b> )	Jpeg	←	←	√			L/R/G
	Height of the graphics to be saved ( <b>Height</b> )	421	←	←	√			L/R/G
	Width of the graphics to be saved ( <b>Width</b> )	516	←	←	√			L/R/G
	Latest file name(s) displayed on the buttons in the Save/Recall toolbar	(None)	No effect	←	√		√	L/R

\*1. "No effect" when **Cal Kit Type** is 7 mm and calibration is on while in the fixed frequency/fixed power point mode (**Cal Menu [Fix]**).

Initial Settings

**Initial Settings, Settings that can be Saved/Recalled, Settings that can be Backed Up**



---

## H Comparison Information of 4291B and E4991A

Comparison information of the Agilent 4291B and the Agilent E4991A (excluding GPIB command comparison) is given in this appendix. Refer to Appendix D of the *Programming Manual* (“4291B vs. E4991A GPIB Command Comparison Chart”) for a comparison of the instruments’ GPIB commands.

## Major Differences

### Channels and Traces

#### Changes in concept

The 4291B has two channels. Both channels can sweep together or separately under two independent conditions (for example, frequency sweep and OCS level sweep). Impedance measurement results of each channel are converted into the selected parameter and then displayed.

On the other hand, the closest thing to a channel concept in the E4991A is its having five traces (3 scalar and 2 complex). The difference between channel and trace is that conditions, including the sweep condition, can be set independently in the channel concept, while all such conditions are common to all traces in the trace concept.

#### Changes in functions

- The 4291B can simultaneously display a maximum of two kinds of parameters, but the E4991A can simultaneously display a maximum of five kinds of parameters (3 scalar, 2 complex).
- The 4291B can sweep based on two kinds of sweep parameters (for example, frequency sweep and OSC level sweep), but the E4991A cannot do this.

### Calibration/Compensation

#### Changes in concept

In the 4291B, the calibration/compensation procedure (calibrate on the designated calibration plane and compensate error elements of the test fixture) was complicated for some users, so they used the instrument without appropriate calibration/compensation. In the E4991A, the calibration/compensation procedure is simplified to prevent such difficulties. In the normal procedure, Open/Short/Load compensation is executed after executing Open/Short/Load/Low loss capacitor calibration. In the E4991A, error compensation can be done by executing Open/Short/Load calibration on the test fixture material contact plane.

#### Changes in functions

- The 4291B has LOAD compensation, but the E4991A doesn't because of the concept described above.
- Just one reference value of the LOAD calibration is set to cover the entire frequency range in the 4291B, but separate reference values of LOAD calibration can be set for each frequency point in the E4991A (this setting can be made by just issuing a GPIB command).
- The 4291B has two modes: USER mode (both frequency and OSC level are set by the user) and FIXED POINT mode (both frequency and OSC level are fixed). On the other hand, the E4991A has an additional user setting mode in which frequency is fixed and OSC level is set by users.

---

#### NOTE

For details on the E4991A's calibration/compensation functions, see Chapter 4,

---

“Calibration and Compensation,” on page 75.

## Marker

### Marker

One main marker and 7 sub-markers are available with the 4291B. Marker functions such as marker search are available for only the main marker.

On the other hand, eight markers are available with the E4991A. There is no main/sub concept as with the 4291B, but instead the E4991A has a new active marker concept. Any marker can be specified as the active marker, and marker functions such as marker search can be carried out with the active marker in the same manner as with the 4291B’s main marker. In other words, each of the eight markers can be used as a main marker.

### $\Delta$ Marker

A  $\Delta$  marker is used as a base to indicate relative value against any point in the 4291B.

On the other hand, a reference marker is used as a base to indicate relative value against any point in the E4991A. The same functions as those of a normal marker are available to the reference marker if it is specified as the active marker. Consequently, there is no tracking  $\Delta$  marker function as with the 4291B. Also, the E4991A’s reference marker can be used as the ninth marker if  $\Delta$  mode is set to the OFF condition.

---

#### NOTE

For details on the E4991A’s marker functions, see Chapter 6, “Analysis of Measurement Results,” on page 127.

---

## Limit test

The maximum and minimum limit values for several measurement points (a maximum 18 points) can be specified and the judgment of PASS/FAIL can be made by using the lines connecting these points (limit lines) with the 4291B. The entire sweep range is the object of PASS/FAIL judgment because the maximum and minimum limit lines are drawn through the entire sweep range and this judgment is made based on whether the measurement results (data trace) are within the range. The overall judgment result for all measurement points (on screen and GPIB output) and the judgment result for each measurement point (only GPIB output) are available.

On the other hand, the maximum and minimum limit values at the marker location are specified and the PASS/FAIL judgment is made in the E4991A. Only the measurement result at the marker location is the object of PASS/FAIL judgment. Nine markers (8 markers, 1 reference marker) are available. Objects of judgment are a maximum of nine. The entire sweep range cannot be the object of judgment as with the 4291B. The overall judgment result for all marker locations (on measurement screen and GPIB output) and the judgment result for each marker location (on limit test table screen and GPIB output) are available.

---

#### NOTE

For details on the E4991A’s limit test functions, see “Setting a Limit to the Trace and Making a Pass/Fail Determination” on page 160.

---

## Function Comparison List

Table H-1 compares the functions of the 4291B with those of the E4991A.

**Table H-1 Function Comparison List**

			4291B	E4991A
Measurement performance	Frequency	Range	<b>1 MHz to 1.8 GHz</b>	<b>1 MHz to 3 GHz</b>
		Resolution	1 mHz	1 mHz
	OSC level	Voltage ranges (in open condition)	<b>0.2 mVrms to 1 Vrms (@≤1 GHz)</b> <b>0.2 mVrms to 0.5 Vrms (@&gt;1 GHz)</b>	<b>4.47 mVrms to 502 mVrms (@≤1 GHz)</b> <b>4.47 mVrms to 447 mVrms (@&gt;1 GHz)</b>
		Electric current ranges (in short condition)	<b>4 μArms to 20 mArms (@≤1 GHz)</b> <b>4 μArms to 10 mArms (@&gt;1 GHz)</b>	<b>89.4 μArms to 10 mArms (@≤1 GHz)</b> <b>89.4 μArms to 8.4 mArms (@&gt;1 GHz)</b>
		Power ranges (in 50Ω end terminal condition)	<b>-67 dBm to 7 dBm (@≤1 GHz)</b> <b>-67 dBm to 1 dBm (@&gt;1 GHz)</b>	<b>-40 dBm to 1 dBm (@≤1 GHz)</b> <b>-40 dBm to 0 dBm (@&gt;1 GHz)</b>
	DC Bias	Voltage range	0 V to ±40 V	0 V to ±40 V
		Electric current ranges	<b>-100 mA to -20 μA</b> <b>20 μA to 100 mA</b>	<b>-50 mA to -100 μA</b> <b>100 μA to 50 mA</b>
	Basic accuracy		0.8%	0.8%
	Impedance measurement range		<b>100 mΩ to 40 kΩ (@ 1 MHz, &lt;10%)</b>	<b>130 mΩ to 20 kΩ (@ 1 MHz, &lt;10%)</b>
Test station (head)	Cables		<b>1.8 m</b>	<b>0 m</b> (Direct connection)
	Terminals		7 mm	7 mm
	Heads		<b>High impedance type</b> <b>Low impedance type</b>	<b>Only one type</b>
Number of channels			2	No channel concept
Traces			Data trace Memory trace ( <b>multiple</b> ) User trace	Data trace Memory trace
Measurement parameter	Number of parameters that can be displayed on screen		Maximum <b>2</b>	Maximum <b>5</b> (scalar: 3, complex:2)
	Selectable parameters		Impedance measurement: $ Z $ , $\theta_z$ , R, X, $ Y $ , $\theta_y$ , G, B, $ \Gamma $ , $\theta_\Gamma$ , $\Gamma_x$ , $\Gamma_y$ , Cp, Cs, Lp, Ls, Rp, Rs, D, Q Dielectric/Magnetic material measurement (option): $\epsilon_r'$ , $\epsilon_r''$ , $\tan\delta(\epsilon)$ , $ \epsilon_r $ , $\mu_r'$ , $\mu_r''$ , $\tan\delta(\mu)$ , $ \mu_r $	Impedance measurement: $ Z $ , $\theta_z$ , R, X, $ Y $ , $\theta_y$ , G, B, $ \Gamma $ , $\theta_\Gamma$ , $\Gamma_x$ , $\Gamma_y$ , Cp, Cs, Lp, Ls, Rp, Rs, D, Q Dielectric/Magnetic material measurement (option): $\epsilon_r'$ , $\epsilon_r''$ , $\tan\delta(\epsilon)$ , $ \epsilon_r $ , $\mu_r'$ , $\mu_r''$ , $\tan\delta(\mu)$ , $ \mu_r $

**Table H-1 Function Comparison List**

		4291B	E4991A	
Display	LCD	8.4 inch (color)	8.4 inch (color)	
	Display formats		Linear Logarithms Polar chart Smith chart Admittance chart Complex plane	Linear Logarithms Polar chart Smith chart Admittance chart Complex plane
	Phase display	Unit	Degree Radian	Degree Radian
		Expanded phase indication function	Yes	Yes
	Divided display function of each trace		Yes	Yes
	List display function of measurement results		Yes	Yes
	Data calculation function among traces		<b>Addition: DATA+MEM</b> Subtraction: Data-MEM Division: DATA/MEM <b>Multiplication: DATA*MEM</b>	Subtraction: Data-MEM Division: DATA/MEM (Only complex)  $\Delta\%: (DATA-MEM)/DATA*100$ (Only scalar)
	Gain and offset calculation functions		<b>Gain</b> and offset calculation	Offset calculation
	Title display function		Yes	Yes
	Label display function		<b>Yes</b>	<b>No</b>
	Trace selection		Data Memory Data & Memory <b>User</b>	Data Memory Data & Memory (calculation results of trace and memory cannot be displayed simultaneously)
	Grid display switch function		<b>Yes</b>	<b>No</b>
	Screen color adjustment functions		Yes	Yes
	Frequency display	blank (non-display)	<b>Available</b>	<b>Not available</b>
		Number of digits	<b>Fixed</b>	<b>Not fixed</b> (can change)
Automatic scale adjustment function		Yes	Yes (Possible to execute on all trace in one time.)	
Equivalent circuit analysis function	Equivalent circuit types	Inductor with large core loss Inductor and resistor Large resistor Capacitor Resonator	Inductor with large core loss Inductor and resistor Large resistor Capacitor Resonator	
	Functions	Equivalent circuit parameter calculation Frequency characteristic simulation	Equivalent circuit parameter calculation Frequency characteristic simulation	
Averaging	Sweep averaging	Averaging factor: 1 to 999	Averaging factor: 1 to 999	
	Point averaging	Averaging factor: 1 to <b>999</b>	Averaging factor: 1 to <b>100</b>	

Comparison Information of 4291B and E4991A  
**Function Comparison List**

**Table H-1 Function Comparison List**

				4291B	E4991A
Calibration	Types			Open Short Load Low loss capacitor	Open Short Load Low loss capacitor
	Measurement points of calibration data			Frequency and OSC level are fixed.  Frequency and OSC level are set by users.	Frequency and OSC level are fixed. <b>Frequency is fixed and OSC level is set by users.</b> Frequency and OSC level are set by users.
	Calibration kit			7 mm User	7 mm User
	Definition of user calibration kit	Definition parameters	Open	G-C	G-C
			Short	R-L	R-L
Load			<b>R-X</b>	<b>R-L</b>	
Save function		<b>Yes</b>	<b>No</b> (User calibration kit setup is saved by saving Instrument setup.)		
Compensation	Types			Open Short <b>Load</b>	Open Short
	Measurement points of compensation data			Frequency and OSC level are fixed. Frequency and OSC level are set by users.	No selection (Combined with setup of calibration data measurement points. Cannot be set independently.)
	Definition of user compensation kit	Definition parameters	Open	G-C	G-C
			Short	R-L	R-L
			Load	R-L	No Load compensation
	Save function		<b>Yes</b>	<b>No</b> (User calibration kit setup is saved by saving Instrument setup.)	
Port extension compensation			Yes	Yes	
Fixture selection (Electrical length compensation)	Selectable fixtures			16191A, 16192A, 16193A, 16194A,  16453A (Option), 16454A (Option), User	16191A, 16192A, 16193A, 16194A, <b>16196A, 16196B, 16196C, 16197A,</b> 16453A (Option), 16454A (Option), User
	Save function of user fixture definition contents			<b>Yes</b>	<b>No</b> (User fixture setup is saved by saving Instrument state.)

**Table H-1 Function Comparison List**

			4291B	E4991A	
Sweep	Sweep time		Automatic/Manual	Automatic/Manual	
	Delay		Point delay Sweep delay	Point delay Sweep delay <b>Segment delay</b>	
	Measurement points		2 to 801	2 to 801	
	Combination between channels		Combined/Independent	No channel concept	
	Sweep parameter		Frequency OSC level DC bias voltage (Option) DC bias current (Option)	Frequency OSC level DC bias voltage (Option) DC bias current (Option)	
	Sweep type	For frequency sweep	Linear Log List	Linear Log List (Name is changed to segment)	
		For OSC level sweep	Linear <b>Log</b>	Linear (Sweep range can be set in dBm, so that same function as Log sweep is available.)	
		For DC voltage/current sweep	Linear	Linear	
	Sweep direction	For frequency sweep	Up	Up/ <b>Down</b>	
		For other sweeps	Up/Down	Up/Down	
	List sweep	Number of segments	<b>15</b>	<b>16</b>	
		Display methods	Frequency base (Linear format)  Order base	Frequency base (Linear format) <b>Frequency base (Log format)</b> Order base	
	Unit setup	Frequency	Sweep range	Hz	Hz
			Fixed value	Hz	Hz
		OSC level	Sweep range	V	V/A/ <b>dBm</b>
Fixed value			V/A/dBm	V/A/dBm	
DC bias		Sweep range	V/A	V/A	
		Fixed value	V/A	V/A	
Trigger	Sweep mode		Continuous Hold Single <b>Number of groups</b>	Continuous Hold Single (Sweep averaging factor in case that it is on)	
	Trigger source		Internal Manual External GPIB	Internal Manual External GPIB	
	Trigger event mode		On point On sweep	On point On sweep <b>On segment</b>	
	Polarity of External trigger		Positive Negative	Positive Negative	

H. Comparison Information of 4291B and E4991A

Comparison Information of 4291B and E4991A  
Function Comparison List

**Table H-1 Function Comparison List**

		4291B	E4991A	
Marker	Number of markers	Main marker: 1 Sub-markers: 7  $\Delta$ marker: 1	Markers: 8 (No distinction between main and sub, the markers designated as active markers have the same functions as previous main markers.) Reference marker: 1	
	Objective trace of markers	Data trace/Memory trace	Data trace/Memory trace	
	Coupled marker trace	Yes	Yes	
	Marker movement mode	Continuous/Discrete	Continuous/Discrete	
	$\Delta$ marker (Reference marker)	Mode	$\Delta$ /Fixed $\Delta$	$\Delta$ /Fixed $\Delta$
		Movement	Move the main marker with tracking (Tracking $\Delta$ marker)	Independently move with normal marker function by specifying the reference marker as active marker.
	Setup of sweep range with using marker	Setting stimulus value of the marker location as center value/start value/stop value	Available	Available
		After searching peak value, setting stimulus value of the marker location as center value	Available	Not available (The same function is available in combination with the peak search function.)
		Setting range between the marker and $\Delta$ marker as sweep range	Available	Available
		Setting subtraction between the marker and $\Delta$ marker stimulus values as the center value	<b>Available</b>	<b>Not available</b>
		After changing stimulus value of marker location to the center value, zoom sweep range.	Available	Not available (Zooming of the area defined by mouse is available. But setup of sweep range does not change.)
	Setting the marker location's measurement value as the scale reference value	Available	Available	
	Search	Type of search	Maximum value/Minimum value/Target value/Peak value (Positive or negative is selectable by definition of the peak.)	Maximum value/Minimum value/Target value/Positive peak value
		Search tracking function	Available	Available
		Bandwidth search function	<b>Available</b>	<b>Not available</b>
		Partial search function	Available	Available
	List display	Available (Traces of both channels cannot be displayed simultaneously while the list is displayed.)	Available	
	Statistical analysis	Average value Standard deviation Peak-Peak value	Average value Standard deviation Peak-Peak value	



**Table H-1 Function Comparison List**

		4291B	E4991A	
Marker (Continued)	Display formats of the marker for indicating complex numbers	Real part and imaginary part Absolute value (Linear display) and phase Absolute value (Log display) and phase Resistance and reactance Conductance and susceptance Reflection coefficient and phase	Real part and imaginary part Absolute value (Linear display) and phase Absolute value (Log display) and phase Resistance and reactance Conductance and susceptance Reflection coefficient and phase	
	Display formats of stimulus value	Stimulus value Time Relaxation time	Stimulus value Time Relaxation time	
	Level monitor functions	<b>OSC voltage value</b> <b>OSC current value</b> DC bias voltage value DC bias current value	(OSC level can not be monitored)  DC bias voltage value DC bias current value	
Limit test		PASS/FAIL judgment of <b>all measurement points by using limit lines</b>	PASS/FAIL judgment of <b>a maximum nine measurement points by using markers</b>	
Beep sound		Three types (Operation completion type/Warning type/Limit test type)	One type (Common to all functions)	
Print		Color Black and white	Color ( <b>inverse</b> ) Black and white	
Save/ Recall	Storage device		<b>Internal memory (volatile)</b> Floppy disk	
	File format		DOS <b>LIF</b>	
	File types	Save	Instrument setup state Measurement data (ASCII/Binary)  Image on LCD screen (tiff)	Instrument setup state Measurement data (ASCII/Binary/ <b>CITIfile</b> ) Image on LCD screen (jpeg/BMP)
		Recall	Instrument setup state Measurement data (Binary)	Instrument setup state Measurement data (Binary)
	Automatic recall function		Yes	Yes
	File management functions		Copy Delete Create folder Change current folder	Copy Delete Create folder Change current folder
	File transfer		<b>By GPIB command</b>	<b>By FTP (through LAN)</b>
	Floppy disk formatting function		<b>Yes</b>	<b>No</b>
Interfaces		GPIB  Centronics  <b>General parallel I/O</b>	GPIB <b>LAN (10Base-T/100Base-Tx)</b> Centronics	
Remote control		GPIB	GPIB, <b>LAN (Remote U/I)</b>	
Programming		<b>Instrument BASIC</b>	<b>VBA Macro</b>	
GPIB command types		SCPI, <b>Simple</b>	SCPI	

Comparison Information of 4291B and E4991A  
Function Comparison List

**Table H-1 Function Comparison List**

		4291B	E4991A
Data input and output	Data transfer format	ASCII IEEE 32 bit floating-point IEEE 64 bit floating-point <b>MS-DOS</b>	ASCII IEEE 32 bit floating-point IEEE 64 floating-point (Byte order can be selected, so MS-DOS format can be used.)
	Output/Input data	Data trace array Memory trace array Data array Memory array (Only output) Raw data array Calibration coefficient array  Compensation coefficient array  Compensation standard array Level monitor array	Data trace array ( <b>only output</b> ) Memory trace array ( <b>only output</b> )  Raw data array ( <b>only output</b> ) Calibration coefficient array <b>Calibration data array (only output)</b> Compensation coefficient array <b>Compensation data array (only output)</b> <b>Calibration standard array</b> Compensation standard array Level monitor array ( <b>only output</b> )
Status report functions	Register structure	Status byte register Standard event status register Operation status register <b>Instrument event status register</b>	Status byte register Standard event status register Operation status register <b>Questionable status register</b> <b>Questionable status hardware register</b> <b>Questionable status limit register</b> <b>Questionable status search register</b>
	Information to be obtained	Error generation Sweep completion Point measurement completion Calibration/Compensation completion Waiting trigger Limit test failure Marker search failure <b>Data input completion</b> <b>Printing</b> <b>Executing Program</b>	Error generation Sweep completion Point measurement completion Calibration/Compensation completion Waiting trigger Limit test failure Marker search failure <b>Valid Calibration/Compensation</b> <b>Hardware failure</b>
Internal clock		Yes	Yes
Outer dimensions	Main body	426 (W) × 235 (H) × <b>553 (D)</b> mm	426 (W) × 235 (H) × <b>445 (D)</b> mm
	Test station (Head)	<b>275 (W) × 95 (H) × 205 (D)</b> mm	<b>160 (W) × 64 (H) × 163 (D)</b> mm
Weight	Main body	<b>21.5 kg</b>	<b>17 kg</b>
	Test station (Head)	<b>3.7 kg</b>	<b>1 kg</b>

---

# I Messages

The E4991A can display error messages as well as messages that indicate the internal operating status of the equipment. This appendix explains what these messages mean by listing them in alphabetical order. The *Programming Manual* lists error messages in order of error number.

Messages showing the status of the E4991A are displayed in the lower-left area of the E4991A LCD screen. These messages include error messages that occur during the execution of GPIB commands and others that indicate the internal status of the equipment.

Error messages are indicated following the character string “[Err]” and can be read out by a GPIB command. Other kinds of messages are indicated without the “[Err]” character string and cannot be read out by a GPIB command. This section explains the meaning of each message and how to resolve the problem it indicates.

---

## Alphabetical Order

Errors with negative error numbers are basically general errors for GPIB instruments defined by IEEE488.2. On the other hand, errors with positive error numbers have been defined specifically for the E4991A.

### A

6

#### **Additional standards needed**

Before completing data measurement that requires calculation of the calibration coefficient, a GPIB command is sent to turn the calibration function On. For example, when only measurement of the Open Standard and Short Standard, but not the Load Standard, of the calibration kit has been completed, the SENS:CORR1:COLL:SAVE command is attempted in order to set the calibration function On.

Measure all of the necessary calibration data.

### B

-168

#### **Block data not allowed**

Block data is received at a position where the E4991A cannot allow a block data element.

### C

10

#### **Cal measure aborted**

One of the following problems has occurred.

- During measurement of the necessary calibration/fixture compensation data, or during and after the calculation of calibration/fixture compensation coefficients (with calibration function turned On), the settings of calibration/fixture compensation acquired data points (**Fixed, Full Range, Fixed, User Pwr** or **User Freq & Pwr**) have been altered. All measured calibration/fixture compensation data acquired thus far and/or the calibration/fixture compensation function have been invalidated.
- While the calibration/fixture compensation acquired data point setting is in the user-defined point condition (**User Freq & Pwr**), the sweep condition (Sweep Range, Sweep Parameter, Measurement Points, and Sweep Type) has been altered during measurement of the necessary calibration/fixture compensation data, or during and after the calculation of calibration/fixture compensation coefficients (with the

calibration function turned On). All measured calibration/fixture compensation data acquired thus far and/or the calibration/fixture compensation function have been invalidated.

- During measurement of the necessary calibration data, the measurement has been interrupted by the **Abort Cal Meas** button. The calibration data have been invalidated.

In order to recover the calibration/fixture compensation function or the equipment setting valid just prior to the event, click the **Recover Cal/Compen** state button. Also, if necessary, retry measurement of the calibration/fixture compensation data.

7 **Calibration required**

While the calibration function is not set to On, a GPIB command has been sent even though that command can only be executed while the calibration function is On. For example, when the calibration function is Off, the SENS:CORR2:COLL command has been attempted in order to measure fixture compensation data.

After measuring all necessary data, turn the calibration function On.

31 **Can't calculate equivalent parameters**

The measured data are not suitable for approximate calculation into the equivalent circuit parameters selected in the equivalent circuit model.

Retry measurement or select an appropriate equivalent circuit model.

62 **Can't execute data examination**

Even though the data for statistic analysis has been acquired, an attempt has been made to read out the statistic analysis results by changing the setting conditions (such as sweep start rate) and using the CALC{1-5}:MST:DATA? command before the measurement has been updated.

After changing the setting conditions, wait for the measurement to be updated and then read out the statistic analysis results.

-148 **Character data not allowed**

Character data has been received at a position where the E4991A cannot allow a character data element. For example, when the program message "CALC1:MARK:FUNC:TARG MAX" is sent instead of the correct program message "CALC1:MARK:FUNC:TARG le-12", the character data element is regarded by the E4991A as invalid.

Refer to the command reference and check the parameter to be used for that command.

-100 **Command error**

An error has occurred for which the E4991A could not grammatically specify the error message. This shows that a command error defined by IEEE488.2,5.1.1.4 has occurred.

13 **Comp measure aborted**

During measurement of the necessary fixture compensation data, the measurement has been interrupted by the **Abort Compen Meas** button. The fixture compensation data has been invalidated.

Retry measuring the fixture compensation data if necessary.

- 11                   **Compensation Required**
- Before finishing the measurement of fixture compensation data, a command has been sent to turn the fixture compensation function On. For example, before measurement of Open Compensation Data has been finished, the SENS:CORR2:COLL:OPEN command has been attempted in order to set the Open Compensation Function in the fixture compensation functions to On.
- Measure the necessary fixture compensation data.
- D**
- 230               **Data corrupt or stale**
- Data may be invalid. Also, a newly reading procedure may have been started but not completed since the most recent access.
- 222               **Data out of range**
- A data element well out of the E4991A's defined range (but not violating the standard) has been received.
- 104               **Data type error**
- The parser has recognized a data element that is not supposed to exist. For example, even though numerical figure or character string data are expected, block data have been sent.
- Define the type of recognized data.
- E**
- 200               **Execution error**
- An execution error has occurred for which the E4991A could not specify the error message. This code shows that an execution error defined in IEEE488.2, 11.5.1.1.5 has occurred.
- 123               **Exponent too large**
- The absolute figure of the exponent has exceeded 32,000. (refer to IEEE488.2, 7.2.4.1).
- 178               **Expression data not allowed**
- An expression data element has been received at a position where the E4991A does not allow expression data elements.
- 170               **Expression error**
- During structure analysis of the expression data, there has been an error that does not apply to a situation between errors -171 and - 179.

## F

-256

### File name not found

A designated file could not be found and the command has not been correctly executed. For example, attempts have been made to read and write on a file that does not exist or a disk has not been properly inserted.

95

### Frequency sweep only

A command that is only valid when the sweep parameter is in frequency has been sent. For example, when a sweep parameter other than frequency is set, the `CALC{1-5}:MARK:UNIT` command is attempted in order to set the marker X-axis display to relaxation time ( $1/2\pi f$ ).

First, use the `SWE:TYPE` command to set the sweep parameter to frequency.

## G

-105

### GET not allowed

While receiving a program message, the Group Execution Trigger (GET command in HTBasic) has been inputted (refer to IEEE488.2, 7.7). For example, a wait command such as `*OPC?`, or `*WAI` has been sent.

## I

-224

### Illegal parameter value

The parameter value is not appropriate. For example, when the program message `*DISP:TRAC1:Y:SPAC OBAS` has been sent instead of the correct program message `*DISP:TRAC1:Y:SPAC LOG`, the parameter rate is regarded by the E4991A as inappropriate.

Refer to the command reference and confirm that the parameter value is correctly inputted.

71

### Impedance measurement mode only

A command has been sent that is only valid for Impedance Measurement Mode. For example, during the Magnetic Material Measurement Mode, the `SENS:CORR2:CKIT:STAN1:C` command has been attempted in order to define the user defined fixture compensation kit.

Select Impedance Measurement Mode.

-213

### Init ignored

Because another measurement is already underway, the Measurement Initialize Request (`*INIT` command) has been ignored. For example, this happens when changing the setting of `*INIT:CONT` to `OFF` and the `*TRIG:SOUR` command to `BUS` or when attempting a trigger with the `*TRG` command. If the `*INIT` command is sent to the E4991A before the sweep is completed (without a wait time), it is regarded as an invalid command.

-161

### Invalid block data

Even though the block data is expected, the received block data is invalid for some reason (refer to IEEE488.2, 7.7.6.2). For example, before the length of block data has been filled, an END message is received.

## Messages

### Invalid character

#### -101 **Invalid character**

In the error message character string, an invalid character has been found. For example, when a message "SENS:CORR1:COLL:FPO USER" is sent toward the proper program message; "SENS:CORR1:COLL:FPO&USER", the ampersand symbol (&) will be perceived by E4991A as an invalid character. In case the parameter is inputted at the end, provide space between the command and the parameter.

#### -121 **Invalid character in number**

There are invalid characters in the received data and type. For example, an alphabetic character has been found in a decimal numeric or a "9" has been found in octal data.

#### -171 **Invalid expression**

An expression data element is invalid (refer to IEEE488.2, 7.7.7.2). For example, the brackets are not paired or the character violates the standard.

#### 106 **Invalid file name**

During the execution of file save/recall command, the character string contained an inappropriate file name. For example, when executing a recall command, the file name extension was incorrect.

Specify an appropriate file name.

Also, when saving data on a floppy disk, this error message will be shown if the disk is not properly inserted or the disk is write-protected.

#### 77 **Invalid material size**

The definition of the size of the test material in a Magnetic Material Measurement is invalid. For example, an attempt has been made to set the outer diameter of the test material to a smaller figure than the inner diameter.

Set the outer diameter of the magnetic material to a larger size than that of the inner diameter.

#### -103 **Invalid separator**

When the parser (compiler) is expecting a separating symbol, a character that is not a separating symbol has been sent. For example, when the program message "SENS:CORR1:COLL:FPO USER \*OPC?" is sent instead of two program messages correctly separated by a semi-colon as "SENS:CORR1:COLL:FPO USER;\*OPC?" the instrument cannot perceive the separation. When sending two program messages simultaneously, be sure to insert a separating symbol such as a semi-column (;) between the two messages.

#### -151 **Invalid string data**

Even though character string data are expected, the received character string is invalid for some reason (refer to IEEE488.2, 7.7.2.4). For example, the END message has been received before the closing quotation mark character appeared.

#### -131 **Invalid suffix**

The suffix (here meaning Unit) does not following the sentence structure defined by IEEE488.2, 7.7.3.2, or the suffix is not appropriate for the E4991A. For example, when the program message "SOUR:VOLT:STAR 10dbm" has been sent instead of the correct program message "SOUR:VOLT:STAR 10mV", the suffix is regarded by the E4991A as invalid. Refer to the command reference to confirm the unit that should be used for this



command.

## M

-272

### Macro execution error

An execution error related to the E4991A's macro functions has occurred.

-261

### Math error in expression

A program data element that is a syntactically legal expression could not be executed due to a math error such as an attempted divide-by-zero.

-109

### Missing parameter

A parameter is insufficient for a command, or the parameter has not been inputted. For example, the **SWE:POIN** command requires 1 parameter, so when the program message "SWE:POIN" has been sent instead of the correct program message "SWE:POIN 201", it is regarded as invalid by the E4991A because no parameter has been inputted.

Make sure to input a parameter for any command that requires one.

32

### Must be more than 2 points for analysis

Measurement points within the sweep range are set to 2 (if the partial search function is On within the designated Searching range), so calculation of the equivalent circuit parameter (**Calculate Parameter** button or **CALC{1-5}:EPAR** command) could not be executed.

Measurement points within the sweep range (if the partial search function is On within the designated Searching range) must be set to 3 or above.

## N

92

### No active marker

Because the marker is not displayed, the sent command has been ignored. For example, when the marker is not displayed, the **CALC{1-5}:MARK:SET** command has been attempted in order to change the instrument setting of the E4991A.

First use the **CALC{1-5}:MARK{1-8}** command to show the marker on the display.

61

### No data available in memory

This occurs when the marker's Statistic Analysis Function (**Statistics** button) is Off and an attempt has been made to read out the statistic analysis result by using the **CALC{1-5}:MST:DATA?** command.

Turn the Marker's Statistic Analysis Function to On and acquire data for statistic analysis.

113

### No data trace displayed

Because the data trace is not displayed, the sent command has been ignored. For example, when the data trace is not displayed, the **CALC{1-5}:MARK:ON** command has been attempted in order to set a trace displaying a marker as the data trace.

First use the **CALC{1-5}:MATH:FUNC** command to display the data trace.

0

### (no error)

No error has occurred.

This message is not normally shown on the LCD display but returned after the

## Messages

### No fixed delta marker

SYST:ERR? command has been sent by GPIB. When the equipment finds no occurrence of an error, a message is returned as error number 0.

94

#### No fixed delta marker

Because the reference marker is not set to fixed  $\Delta$  mode, the sent command has been ignored. For example, when the fixed  $\Delta$  mode is not set, the CALC{1-5}:MARK:REF:Y command has been attempted in order to set the reference marker to the designated measurement values.

First use the CALC{1-5}:MARK:REF command to display the reference marker. Next, use the CALC{1-5}:MARK:REF:TYPE command to change the setting to fixed  $\Delta$  mode.

90

#### No marker delta - parameter not set

This occurs when the reference marker's  $\Delta$  mode is Off and the CALC{1-5}:MARK:SET command or CALC{1-5}:MARK:FUNC:DOM:SPAN command has been attempted in order to set the  $\Delta$  value to span value within the sweep range or within the partial search range.

First use the CALC{1-5}:MARK:REF command to display the reference marker. Next, use the CALC{1-5}:MARK:REF:TYPE command to set the  $\Delta$  Mode or Fixed  $\Delta$  Mode to On.

114

#### No memory trace displayed

Due to the fact that memory trace is not displayed, a command that has been sent was ignored. For example, when the memory trace is not displayed, the DISP:TRAC{1-5}:Y:FOR command is attempted in order to set the scale setting subject as the data trace.

First use the CALC{1-5}:MATH:FUNC command to display the memory trace.

30

#### No Valid Memory Trace

This occurs when there are no data stored in the Memory Trace and the CALC{1-5}:MATH:FUNC command has been attempted in order to display the Memory Trace.

Before displaying the Memory Trace, use the CALC{1-5}:MATH:MEM command to store the data into the Memory Trace.

140

#### Not allowed for the current trigger source

An invalid command for the presently selected trigger source has been sent. For example, when the trigger source is set to internal trigger (**Internal**), the TRIG:EVENT command has been attempted in order to set the trigger event mode (detecting point for triggering) at each measurement point (**On Point**) or at each (**On Segment**). This operation is valid only when internal trigger is not set as the trigger source.

After setting the trigger source to **Manual**, **External** or **GPIB Bus**, change the Trigger Event Mode.

14

#### Not allowed in power sweep

An invalid command has been sent to the oscillator level sweep while it is in progress. For example, during the oscillator level sweep, the SWE:TYPE command has been attempted in order to set the sweep type to log sweep. This operation is invalid during the oscillator level sweep.

Confirm that the command is valid for the oscillator level sweep.

70

#### Not allowed in this measurement mode

A command has been sent that cannot be executed in the currently set measurement mode. For example, in the Dielectric Measurement Mode, the SENS:CORR1:CKIT command has been attempted in order to set the calibration kit to the defined calibration kit used.

Select a measurement mode in which the command is valid.

80 **Not available for this fixture**

An invalid command has been sent to the currently selected text fixture. For example, when the 16197A is selected, the CALC{1-5}:FORM command is attempted in order to set a prohibited measurement parameter (e.g. complex dielectric constant).

Select an appropriate measurement parameter or display format.

79 **Not available for this format**

The selected measurement parameter or display format could not be executed. For example, in the Dielectric Measurement Mode or in Magnetic Material Measurement Mode, the DISP:TRAC{1-5}:GRAT:FORM command is attempted in order to set a prohibited display format (Smith Chart or Admittance Chart).

Select an appropriate measurement parameter or display format.

47 **Not enough data**

The amount of data transferred to the E4991A by an external controller was less than the amount expected by the E4991A.

Match the amount of data to be transferred with the E4991A measurement points.

-120 **Numeric data error**

An error has been caused by numeric data (including nondecimal numeric types). In errors - 121 to - 129, an unspecified numeric error has occurred.

-128 **Numeric data not allowed**

A numeric data element has been received at a position where the E4991A does not allow numeric data elements. For example, when the program message "CALC1:FORM 3" has been sent instead of the correct program message "CALC1:FORM RS", the numeric data element is received by E4991A as invalid. Refer to the command reference and confirm which parameter should be used for a particular command.

## O

48 **Option not installed**

Because a particular option has not been installed, the sent command has been ignored. For example, when the option 001 (DC bias function) is not installed, the SOUR:VOLT:OFFS command has been attempted in order to set up the DC bias voltage values.

Please contact your nearest Agilent Technologies branch office or the company where you purchased the instrument to install the necessary options.

-321 **Out of memory**

There is a shortage of memory (RAM).

## P

-108 **Parameter not allowed**

## Messages

### Permeability measurement mode only

The parameters have exceeded the number necessary for a command.

For example, when the program message "**SWE:TYPE LIN,SEGM**" is sent instead of the proper program message "SWE:TYPE LIN", 2 parameters are sent even though only 1 parameter is required for this command. Therefore, the number of parameters is regarded as invalid by the E4991A.

Refer to the command reference and check the number of parameters required.

73

### Permeability measurement mode only

A command that is only valid for Magnetic Material Measurement Mode has been sent. For example, in the Dielectric Measurement Mode, the **CALC:FORM:PAR:MGA** command has been attempted in order to set the size of the magnetic substance.

Select Magnetic Material Measurement Mode.

72

### Permittivity measurement mode only

A command that is only valid for Dielectric Measurement Mode has been sent. For example, in the Magnetic Material Measurement Mode, the **SENS:CORR1:CKIT:STAN7:THIC** command has been attempted in order to set the thickness of the load standard for Dielectric Measurement.

Select Dielectric Measurement Mode.

22

### Printer error

The printer has not responded to the control from the E4991A.

Confirm whether the printer's power is On or Off, the connection status of the cable, and the paper supply.

-112

### Program mnemonic too long

The length of a header has exceeded 12 characters. The length of a header here refers to the length of the series of characters that are separated by colons (:).

Refer to IEEE488.2,7.6.4.1 for further details.

## Q

-430

### Query DEADLOCKED

This indicates a condition that has created a "DEADLOCK" Query error (refer to IEEE488.2, 6.3.1.7). This error occurs, for example, when both input and output buffers become full and when the E4991A is no longer able to carry out a process.

-400

### Query error

The E4991A has found a Query error for which it is not able to specify the error message. This code shows that a Query error defined in IEEE488.2, 11.5.1.1.7 or 6.3 has occurred.

-410

### Query INTERRUPTED

This indicates a condition that has created an "INTERRUPTED" Query error (refer to IEEE488.1, 6.3.2.3). This error is generated when, for example, the data byte "DAB" or Get is received after the Query but before its response is fully sent.

-420

### Query UNTERMINATED

This indicates a condition that has created an "UNTERMINATED" Query error (refer to IEEE488.1, 6.3.3.2). This error occurs when the E4991A is designated as a talker (if

**Query UNTERMINATED after indefinite response**

designated as a controller, data transmission is possible via the interface) and receives incomplete program messages. For example, when a command that does not require a Query, such as "**\*CLS**", has been sent as "**\*CLS?**", it is regarded as an incomplete message by the E4991A.

Check the command reference.

**-440 Query UNTERMINATED after indefinite response**

This indicates that a query has been received in the same program message after a query requesting an indefinite response has been executed (refer to IEEE488.2, 6.5.7.5.7).

**R****105 Recall error**

An error has occurred during reading out (recall) of a file. For example, this occurs when an attempt is made to read out a file containing invalid data (such as the extension (.sta) for instrument state files that were saved with equipment other than the E4991A).

Confirm that there is no problem in the file contents.

**S****104 Save error**

While saving a file, an error has been detected on the media in which the data is to be stored. For example, when saving the file to a floppy disk, the space available in the floppy disk is not sufficient.

Check the amount of available space in the media in which the data is to be stored.

**118 Segment table empty or insufficient table**

Because the segment sweep table has not been created, a sent command has been ignored. For example, before the segment sweep table is created, the **SWE:TYPE** command is attempted in order to set a sweep type as the segment sweep.

Before carrying out a segment sweep, create the segment sweep table.

**-221 Settings conflict**

Even though the program data element has been received and it conforms to the standard, execution is not possible with the present condition of the E4991A.

**-150 String data error**

An error caused by a received series of character data elements (quotation mark character) has occurred. In errors - 151 to - 159, an unspecified character string error has occurred.

**-158 String data not allowed**

A string data element has been found at a position where the E4991A does not allow string data elements. For example, when the program message "**TRIG:SOUR "MAN"**" has been sent instead of the correct program message "**TRIG:SOUR MAN**", the double quote (") is regarded by the E4991A as invalid.

Refer to the command reference and confirm whether the double quote (") is required in the parameter of a particular command.

**-138 Suffix not allowed**

## Messages

### Suffix too long

A suffix has been added after numeric data where a suffix (here meaning Unit) cannot be inputted. For example, when the program message "**DISP:TRAC1:Y:PDIV 0.01rad**" has been sent instead of the correct program message "DISP:TRAC1:Y:PDIV 0.01", the suffix is regarded by E4991A as invalid.

Refer to the command reference and confirm that the suffix can be added to the numeric data element.

#### -134 **Suffix too long**

The suffix (here meaning Unit) display is written with more than 12 characters (refer to IEEE488.2, 7.7.2.4).

#### -102 **Syntax error**

An unrecognized command or data type has occurred. For example, when the program message "**SYST:POFF**" is sent instead of the proper program message "**SYST::POFF**", a colon (:) has been incorrectly inserted, and it will be perceived by the E4991A as an unrecognized command.

Delete one colon (:) in order to send the appropriate command.

#### -310 **System error**

In the E4991A, one of the so called "System Errors" has occurred.

## T

#### -124 **Too many digits**

The mantissa of a decimal numeric data element exceeds 255 excluding leading zeros (refer to IEEE488.27.7.2.4).

#### 69 **Too many segments or points**

While editing the list sweep table, a setting has been attempted that exceeds the maximum number of segments (16), the maximum number of measurement points (201) per segment, or the maximum number of total measurement points (801) in all segments.

During setting, the numbers of segments or measurement points should not exceed the maximum figures.

#### -223 **Too much data**

This occurs when the amount of data exceeds the E4991A's memory capacity, even though the program data received in a block, expression, or character string conforms to the standard. The occurrence of this error indicates that the problem is restricted to the memory or memory related devices.

#### -211 **Trigger ignored**

The trigger command "**\*TRG**" or an external trigger signal has been received and detected by the E4991A but was ignored because of the timing (for example, the E4991A trigger was not in the waiting condition).

Prepare for the trigger command or external trigger signal when the trigger is in the waiting condition.

## U

-113

### Undefined header

A command not defined by the E4991A has been received, although grammatical structure does not provide any problem. For example, when the program message "**DISP:TRAC1:X:AUTO**" has been sent instead of the correct program message "**DISP:TRAC1:Y:AUTO**", it is received by the E4991A as an undefined command.

Refer to the command reference and check the correct commands.

15

### User cal mode only

Setting has been attempted by using commands to define each standard of the calibration kit before selecting a user defined calibration kit.

First select the calibration kit that will be used as the user defined calibration kit. Then define each standard value for this calibration kit.

## Messages indicating the internal status of the equipment

Messages that indicate the internal status of the equipment include equipment irregularities as well as the results of processing (or current processing status). These messages do not have numbers.

### Messages indicating measurement failure

#### DC bias overload

During application of DC bias voltage, a sudden change in the connection condition of the DUT has lowered the direct-current impedance, resulting in momentary over-current at the DC bias source.

Do not remove the DUT during application of DC bias. If this error occurs frequently during normal measurement, this may be due to instrument failure. In this event, please contact your nearest Agilent Technologies branch office or the company where you purchased the instrument.

#### PLL Unlock

An error has been detected in the internal PLL (Phase Lock Loop) circuit of the E4991A. The PLL is used to generate a stable frequency source. This can occur due to an error of the external reference signal or when the power is turned ON in a low-temperature environment.

If the external reference signal has not been inputted or shows no error, instrument tuning or repair is necessary. If the message does not disappear in a few minutes after turning the power ON, instrument tuning or repair is necessary. In this event, please contact your nearest Agilent Technologies branch office or the company where you purchased the instrument.

#### Power on test failed

An error has been detected during the self-test after turning on the power.

Please contact your nearest Agilent Technologies branch office or the company where you purchased the instrument.

#### RF overload

There has been a ranging failure in the internal circuit due to a sudden change in impedance caused by removing the DUT or some other reason during measurement.

Do not remove the DUT during measurement. If this error occurs frequently during normal measurement, there may be instrument failure. In this event, please contact your nearest Agilent Technologies branch office or the company where you purchased the instrument.



## **Messages indicating the results (or current status) of processing**

### **Cal done**

Calculation and storage of a calibration coefficient completed.

### **Cal measure aborted**

Measurement of calibration data aborted.

### **Comp done**

Calculation and storage of a fixture compensation coefficient completed.

### **Comp measure aborted**

Measurement of a fixture compensation coefficient aborted.

### **Peak not found**

Peak search function executed, but no defined peak was found.

### **Target value not found**

Target search function executed, but no target measurement value was found.

### **Trigger hold**

Measurement is in hold mode, in which a trigger is not accepted.

### **Wait -- measuring cal standard**

Calibration data are now being measured.

### **Wait -- measuring comp standard**

Fixture compensation data are now being measured.

Messages

**Wait -- measuring comp standard**

**Symbols**

$\Delta T$ , 299, 303  
 $\Delta T_{max}$ , 299, 303  
 [ .. ], 169  
 [Cal/Compel] key, 24  
 [Display] key, 24  
 [Marker Fctn] key, 24  
 [Marker] key, 24  
 [Meas/Format] key, 24  
 [Preset] key, 26  
 [Save/Recall] key, 26  
 [Scale] key, 24  
 [Source] key, 24  
 [Start/Stop] key, 24  
 [Sweep] key, 24  
 [System] key, 26  
 [Trace] key, 24  
 [Trigger Setup] key, 24  
 [Trigger] key, 24  
 [Utility] key, 26  
 ~LINE, 29

**Numerics**

007, 333  
 010, 321  
 1 Port option button  
   CITIfile, 181  
 2 Port A option button  
   CITIfile, 181  
 2 Port B option button  
   CITIfile, 181  
 3.5" built-in floppy disk drive, 23

**A**

A button  
   function list by menu, 413  
 Abort button  
   function list by menu, 419  
 Abort Cal Meas button  
   function list by menu, 406  
 Abort Compen Meas button  
   function list by menu, 406  
 About E4991A button  
   function list by menu, 418  
 Accurac  
   Open/Short/Load/Low-Loss Capacitor Calibration is  
   Performed, 245  
 Accuracy  
   Open/Short/Load Calibration is performed, 244  
 active trace  
   selection and confirmation, 45  
 Active trace axis  
   LCD Display display areas, 38  
 Add Segment button  
   function list by menu, 400  
 Address:Controller box

  function list by menu, 419  
 Address:E4991A box  
   function list by menu, 419  
 Agilent E4991A-007 Compensation Library, 341  
 All Off button, 129  
   function list by menu, 389  
 All option button  
   in Print dialog box, 189  
 analysis of measured results, 127  
 arrow keys, 25  
 ASCII format data saving, 175  
 ASCII/Binary option button, 172  
 assistance, 6  
 auto scale, 107  
 automatic recall, 170  
 autorec.sta, 170  
 Autoscale All button  
   function list by menu, 380  
 Autoscale button  
   function list by menu, 380  
 Averaging  
   Specification, 253  
 averaging  
   point  
     calculation formula, 73  
   point averaging, 73  
   sweep-to-sweep  
     calculation formula, 71  
   sweep-to-sweep averaging, 71

**B**

B button  
   function list by menu, 413  
 Backed Up  
   Settings, 440  
 Beep[ ] button  
   function list by menu, 418  
 BEGIN  
   CITIfile, 181  
 Bias Level box (**Stimulus-Source...**)  
   function list by menu, 403  
 Bias Level box (**Stimulus-Sweep Setup-Segment Table**  
   Menu-More)  
   function list by menu, 402  
 Bias Limit box (**Stimulus-Source...**)  
   function list by menu, 403  
 Bias Limit box (**Stimulus-Sweep Setup-Segment Table**  
   Menu-More)  
   function list by menu, 402  
 Bias Monitor button, 60  
 Bias Monitor[ ] button (**Stimulus-Source...**)  
   function list by menu, 403  
 Bias OFF  
   Instrument status bar, 39  
 Bias ON  
   Instrument status bar, 39  
 Bias Source box (**Stimulus-Source...**)

- function list by menu, 403
- Bias Source box (**Stimulus-Sweep Setup**-Segment Table Menu-More)
  - function list by menu, 402
- Blue box
  - function list by menu, 386
- BMP format
  - Save Display Information, 183
- Bottom box, 109
- Bottom box (when display format is linear)
  - function list by menu, 380
- Bottom box (when display is log format)
  - function list by menu, 381
- button
  - function list by menu, 380
- C**
- C button
  - function list by menu, 413
- C0 box
  - function list by menu, 412
- C1 box
  - function list by menu, 412
- Cal Fix
  - Instrument status bar, 39
- Cal Kit Menu[ ] button
  - function list by menu, 404
- Cal Kit Type box (**Stimulus-Cal/Compen**-Cal Kit Menu)
  - function list by menu, 407, 408
- Cal OFF
  - Instrument status bar, 39
- Cal User
  - Instrument status bar, 39
- Cal/Compen key
  - function list by menu, 404
- Calculate Parameters button
  - function list by menu, 412
- Calibration
  - Temperature characteristic test kit, 340
  - Using Probe Sgation, 328
- calibration, 77
- Calibration and Compensation
  - Measurement Support Functions, 252
- calibration and compensation
  - outline of function, 76
  - types of function, 76
  - using 7 mm terminal as the calibration reference plane, 81
  - using DUT connecting terminal as the calibration reference plane, 83
- Calibration Menu[ ] button
  - function list by menu, 404
- Calibration Reset button
  - function list by menu, 406
- Calibration Status/Kit button
  - function list by menu, 387
- Calibration Type box
  - function list by menu, 406
- Calibration/Compensation
  - difference between 4286A and 4287A, 452
- Calibration/Compensation data measurement point
  - Measurement Support Functions, 252
- Calibration/Compensation measurement point mode
  - Using Probe Station, 329
- Cancel/Close key
  - function list by menu, 418
- Cascade Microtech
  - Recommended Probe Stations, 323
- Center box (**Stimulus-Start/Stop...**)
  - function list by menu, 397
- Center button (**Marker-Marker-Mraker To Menu**)
  - function list by menu, 391
- certification, 4
- Change temperature arbitrary
  - Temperature Profile (Tctest.Start), 357
- Change temperature stepwise
  - Temperature Profile (Tctest.Start), 356
- CITIFILE
  - CITIfile keyword, 180
- CITIfile
  - circuit model, 179
  - conversion expression, 179
  - file structure, 180
  - how to create, 179, 181
- CITIfile format data saving, 179
- Cleaning, 434
- click key, 25
- Cmpn OFF
  - Instrument status bar, 39
- Cmpn ON
  - Instrument status bar, 39
- Collate check box
  - in Print dialog box, 189
- color LCD display, 23
- Color Setting Menu button
  - function list by menu, 384
- Compen Kit Menu[ ] button
  - function list by menu, 404
- Compen Open[ ] button
  - function list by menu, 406
- Compen Short[ ] button
  - function list by menu, 406
- Compensaiton.Start
  - Main Menu, 369
- Compensation
  - Temperature characteristic test kit, 340
- Compensation Status/Kit button
  - function list by menu, 387
- Compensation.Start, 351, 369
  - Enter temperature, 370
  - Load temperature compensation data, 369
- Complex 4
  - function list by menu, 378
- Complex 5
  - function list by menu, 378

- 
- CompMeas.bas, 346
  - Conditions for Defining Accuracy
    - Measurement accuracy, 244, 263
    - Temperature Measurement, 276
    - Typical measurement accuracy(Option 007), 282
  - Conditions for Defining Typical Accuracy
    - Measurement accuracy with Temperature Measurement Test Kit, 285
  - Connectors
    - Maintenance, 434
  - Contents check box, 172
  - Continuous button
    - function list by menu, 409
  - continuous sweep
    - executing, 63
  - Control Mode[ ] button
    - function list by menu, 419
  - Copy Data - Memory button
    - function list by menu, 384
  - Copy to Clipboard Graph (bmp) button
    - function list by menu, 386
  - Copy to Clipboard Graph (jpg) button
    - function list by menu, 386
  - Copy to Clipboard List Values button
    - function list by menu, 386
  - Copy to Clipboard Operating Params button
    - function list by menu, 386
  - Copy to FDD button, 169
  - CW Freq box (**Stimulus-Source...**)
    - function list by menu, 403
  - CW frequency
    - setting, 65
  - D**
  - D button
    - function list by menu, 413
  - DATA
    - CITIfile keyword, 180
  - Data
    - in Contents check box, 172
  - data arrays, 166
  - data flow, 167
  - Data section
    - CITIfile, 180
  - data trace arrays, 166
  - DC bias
    - level monitor, 60
    - setting, 60
  - DC Bias Monitor
    - Specification, 241
  - Dc Bias[ ] button (**Stimulus-Source...**)
    - function list by menu, 403
  - DC Current Bias
    - Specification, 241
  - DC Voltage Bias
    - Specification, 241, 242
  - Default box
    - function list by menu, 386
  - Define Trace box
    - function list by menu, 384
  - definition of calibration/compensation kit, 91
  - Definition of Each Parameter
    - Specification, 245
  - Definition of Parameter, 245, 246, 283
  - Definition of Parameter (Option 007), 277
  - Del
    - Instrument status bar, 39
  - Delete button, 169
  - Delete Segment button
    - function list by menu, 400
  - Delta Aux Value box
    - function list by menu, 391
  - Delta Mode box, 131
    - function list by menu, 390
  - Delta Mode Menu button
    - function list by menu, 389
  - $\Delta T$ , 299, 303
  - $\Delta T_{max}$ , 299, 303
  - Delta To Span button
    - function list by menu, 391
  - Delta Value box
    - function list by menu, 391
  - Dimensions
    - Specification, 259
  - Disconnect button
    - function list by menu, 419
  - Display
    - Specification, 253
  - display color
    - changing, 126
  - Display key
    - function list by menu, 384
  - Display Scalar Trace[ ] button
    - function list by menu, 384
  - documentation map, 7
  - Done button (**Stimulus-Cal/Compen-Calibration Menu[ ]**)
    - function list by menu, 406
  - Done button (**Stimulus-Cal/Compen-Fixture Compen Menu[ ]**)
    - function list by menu, 406
  - Drive box, 169
  - Dx, 245
  - E**
  - E button
    - function list by menu, 413
  - E4991A-007 Compensation Library, 341
  - Ea, 245
  - Ea (Option 007), 277
  - Eb, 246
  - Eb (Option007), 277
  - Ec, 246
  - Ec (Option 007), 283
  - Ed, 283
-

- Electrical Delay box
  - function list by menu, 405
- electrical length compensation, 87
- EMC
  - Specification, 258
- END
  - CITIfile, 181
- Enter Password to exit dialog box, 191
- Enter temperature
  - Compensation.Start, 370
- Entry/navigation block, 25
- Environment Conditions
  - Specification, 257
- Equivalent Circuit Analysis
  - Specification, 254
- Equivalent Circuit Menu button
  - function list by menu, 411
- equivalent circuit parameter
  - analyzing, 157
- er Loss box (**Stimulus-Cal/Compen-Cal Kit Menu**)
  - function list by menu, 408
- er Real box (**Stimulus-Cal/Compen-Cal Kit Menu**)
  - function list by menu, 408
- Error Correction
  - Measurement Support Functions, 252
- error message
  - list, 461
- exclusive remedies, 5
- Execute of temperature compensation
  - Tctest.Start, 363
- Exit
  - function list by menu, 420
- Expand Phase[ ] button
  - function list by menu, 379
- Ext Ref In, 30
- Ext Trig, 29
- External monitor output terminal, 29
- External reference signal input connector, 30
  - Specification, 255
- External trigger input connector, 29
  - Specification, 256
- external trigger input signal
  - selecting polarity, 64
- ExtRef
  - Instrument status bar, 39
- F**
- File format
  - Temperature compensation data file, 345
- Fixed frequency point mode
  - Calibration/Compensation data measurement point, 252
- Fixed frequency power point mode
  - Calibration/Compensation data measurement point, 252
- Fixed power point mode
  - Calibration/Compensation data measurement point, 252
- Fixture Compen Menu[ ] button
  - function list by menu, 404
- fixture compensation, 89
- Fixture Type box
  - function list by menu, 405
- floppy disk drive, 23
- Format
  - Temperature compensation data file, 345
  - Temperature Profile, 358
- Format box
  - function list by menu, 379
- FREQ
  - CITIfile, 180
- Freq Disp Resolution box
  - function list by menu, 384
- Frequency
  - Specification, 239, 276
- Frequency Range
  - Material Measurement, 263
  - Material Measurement with Temperature Measurement Test Kit, 285
- front panel
  - names and functions of blocks, 22
- FTP Server Menu button
  - function list by menu, 418
- FTP Server[ ] button
  - function list by menu, 419
- Full Scale box, 109
  - function list by menu, 380
- Fxt Length box
  - function list by menu, 405
- G**
- General Characteristics
  - Specification, 257
- GPIB
  - setting, 194
  - Specification, 255
- GPIB address(chamber)
  - Changing, 372
- GPIB connector, 29
- GPIB Setup Menu button
  - function list by menu, 418
- graph
  - overlay display, 114
  - split display, 114
- Graph Coordination Format
  - selecting, 104
- Green box
  - function list by menu, 386
- H**
- Header section
  - CITIfile, 180
- Heat-resistant cable
  - Cautions, 335
  - Installation, 337
- Height box
  - function list by menu, 413

- High stability frequency reference output connector, 29
  - Specification, 256
- history,
  - manual printing, 2
- Hold
  - Instrument status bar, 39
- Hold button
  - function list by menu, 409
- How to Use This Operation Manual, 19
- HP DeskJet 895C Series
  - printers available, 187
- HP DeskJet 930C Series
  - printers available, 187
- HP DeskJet 970C Series
  - printers available, 187
- I**
- Impedance Measurement Accuracy
  - Calculated Examples, 247
  - Calculated Examples (Option 007), 278
  - Temperature Characteristic Measurement, 277
- Initial Settings, 440
- Inner Diameter box
  - function list by menu, 413
- Installation
  - Temperature characteristic test kit, 335
- Installation and Quick Start Guide, 7
- Instrument status bar
  - LCD Display display areas, 39
- Int Ref Out, 30
- Interface
  - Specification, 255
- internal data flow, 167
- Internal reference signal output connector, 30
  - Specification, 256
- Internal Test button
  - function list by menu, 418
- IP address
  - Setting, 197, 314
- Item box
  - function list by menu, 386
- J**
- JPG format
  - Save Display Information, 183
- K**
- keyboard port, 31
- Keyboard... button, 169
- KYBD, 31
- L**
- L1 box
  - function list by menu, 412
- LAN
  - setup procedures, 309
- LAN interface
  - Specification, 255
- LAN port, 29
- LCD display, 23
- Left button
  - function list by menu, 392
- Limit Marker Test
  - Specification, 254
- limit test
  - marker limit test, 160
- Limit Test [ ] button
  - function list by menu, 395
- Limit Test Menu button
  - function list by menu, 394
- limitation of warranty, 5
- list
  - displaying measurement value in list, 115
- list sweep, 66
- List Values[ ] button
  - function list by menu, 384
- Load L box (**Stimulus-Cal/Compen-Cal Kit Menu**)
  - function list by menu, 407
- Load Program button
  - function list by menu, 411
- Load R box (**Stimulus-Cal/Compen-Cal Kit Menu**)
  - function list by menu, 407
- Load temperature compensation data
  - Compensation.Start, 369
  - Tctest.Start, 364
- Lower box
  - function list by menu, 395
- Low-loss capacitor calibration
  - Measurement Support Functions, 252
- M**
- Macros button
  - function list by menu, 411
- MAG
  - CITIfile, 180
- Main Menu
  - Compensation.Start, 369
  - Tctest.Start, 352
- Main Unit Dimensions
  - Specifications and Supplemental Information, 259
- maintenance, 433
- manual changes, 307
- manual printing history, 2
- Manual Trigger button
  - function list by menu, 409
- Marker
  - Specification, 254
- marker
  - analysis target trace, 139
  - change stimulus value display, 156
  - deleting from trace, 129
  - delta marker, 131
  - limit test, 160

- marker continuous mode, 135
- marker interlocking on/off, 136
- marker list display, 130
- marker value display mode, 137
- moving marker, 129
- reading trace data, 128
- setting reference line value by marker, 112
- turning off, 129
- Marker [Continuous] button, 135
- Marker [Discrete] button, 135
- Marker Couple [Off] button, 136
- Marker Couple [On] button, 136
- Marker Couple[ ] button
  - function list by menu, 389
- Marker Fctn key
  - function list by menu, 392
- Marker key
  - function list by menu, 389
- Marker List[ ] button
  - function list by menu, 393
- Marker On
  - [Data/Memory] button, 139
- Marker On[ ] button
  - function list by menu, 389
- Marker to Left Range button
  - function list by menu, 394
- Marker To Menu button
  - function list by menu, 389
- Marker to Peak Delta button
  - function list by menu, 395
- Marker to Right Range button
  - function list by menu, 394
- Marker value
  - LCD Display display areas, 34
- Marker X Axis box
  - function list by menu, 394
- Marker[ ] button
  - function list by menu, 389
- Markers
  - LCD Display display areas, 38
- Mass Storage
  - Specification, 254
- Material Measurement
  - Measurement Accuracy, 263
    - Typical Effects of Temperature Change, 298
  - typical, 263
- material measurement
  - setting shape parameter, 43
- Material Measurement Parameter
  - Specification, 263
- material measurement parameter
  - setting, 43, 102
- Material Measurement Parameter with Temperature
  - Measurement Test Kit
    - Specification, 285
- Material Measurement with Temperature Measurement Test Kit
  - Measurement Accuracy, 285
- Material Option Menu button
  - function list by menu, 411
- Material Type box
  - function list by menu, 413
- Math Offset box
  - function list by menu, 384
- Meas Load button
  - function list by menu, 405
- Meas Low Loss C button
  - function list by menu, 405
- Meas Open button (**Stimulus-Cal/Compen-Calibration** Menu[ ])
  - function list by menu, 405
- Meas Open button (**Stimulus-Cal/Compen-Fixture** Compen Menu[ ])
  - function list by menu, 406
- Meas Parameter box
  - function list by menu, 379
- Meas Short button (**Stimulus-Cal/Compen-Calibration** Menu[ ])
  - function list by menu, 405
- Meas Short button (**Stimulus-Cal/Compen-Fixture** Compen Menu[ ])
  - function list by menu, 406
- Meas/Format key
  - function list by menu, 379
- Meas/Format menu, 379
- Meas/Format...
  - function list by menu, 379
- Measurement Accuracy
  - Material Measurement, 263
    - Typical Effects of Temperature Change, 298
  - Material Measurement with Temperature Measurement Test Kit, 285
  - Specification, 244
- Measurement accuracy, 276
- Measurement block, 23
- Measurement cable(heat-resistant)
  - Cautions, 335
  - Installation, 337
- Measurement Conditions
  - Tctest.Start, 352
- measurement parameter
  - procedure, 100
- Measurement Parameters
  - Specification, 238
- Measurement Range
  - Specification, 238
- Measurement Support Functions
  - Specifications and Supplemental Information, 252
- Measurement Terminal
  - Specification, 255
- Memory
  - in Contents check box, 172
- memory arrays, 166
- memory trace



- using, 116
- memory trace arrays, 166
- Menu bar
  - LCD Display display areas, 32
- message, 461
- Mini-DIN keyboard port, 31
- Mini-DIN mouse port, 30
- Mkr Delta to Search Range button
  - function list by menu, 394
- More button (**Display-Display...**)
  - function list by menu, 384
- More button (**Marker-Function...**)
  - function list by menu, 393
- More button (**Marker-Marker...**)
  - function list by menu, 389
- More button (**Stimulus-Sweep Setup**-Segment Table Menu)
  - function list by menu, 400
- Mount cable tie, 339
- MOUSE, 30
- Mouse
  - Setup Step, 200
- mouse port, 30
  
- N**
- NAME
  - CITIfile keyword, 180
- Name box
  - in Print dialog box, 188
- names and functions of LCD Display display areas, 32
- Network
  - Configuring, 216
- New Folder button, 169
- Next button
  - function list by menu, 392
- Nominal
  - Definitions, 238
- Non-active trace axes
  - LCD Display display areas, 38
- Non-operating storage condition
  - Specification, 257
- Num Of Traces box
  - function list by menu, 384
- Number of copies box
  - in Print dialog box, 189
- Number of points (NOP)
  - setting, 57
- Number Of Points box (**Stimulus-Sweep Setup...**)
  - function list by menu, 399
- Number Of Points box (**Stimulus-Sweep Setup**-Segment Table Menu)
  - function list by menu, 400
  
- O**
- Offset button
  - function list by menu, 392
- Open C box (**Stimulus-Cal/Compen**-Cal Kit Menu)
  - function list by menu, 407
- Open C box (**Stimulus-Cal/Compen**-Compen Kit Menu)
  - function list by menu, 408
- Open G box (**Stimulus-Cal/Compen**-Cal Kit Menu)
  - function list by menu, 407
- Open G box (**Stimulus-Cal/Compen**-Compen Kit Menu)
  - function list by menu, 408
- Open/Short Compensation
  - , 252
- Open/Short/Load Calibration
  - Measurement Support Functions, 252
  - Using Probe Sgation, 328
- open/short/load/low-loss capacitor calibration, 84, 330
- operating parameter
  - printing, 186
- Operation Param Menu button
  - function list by menu, 384
- Operation Parameters button
  - function list by menu, 387
- Operational Manual, 7
- Option 007, 333
- option 007, 375
- Option 010, 321
  - Overview, 322
- Option 1D5, 29
- Osc Level box, 59
- Osc Level box (**Stimulus-Source...**)
  - function list by menu, 403
- Osc Level box (**Stimulus-Sweep Setup**-Segment Table Menu-More)
  - function list by menu, 402
- Osc Unit box, 59
- Osc Unit box (**Stimulus-Source...**)
  - function list by menu, 403
- Osc Unit box (**Stimulus-Sweep Setup**-Segment Table Menu-More)
  - function list by menu, 402
- Oscillator Level
  - Specification, 239, 276
- oscillator level
  - selecting unit, 59
  - setting, 58
  - setting values, 59
- Outer Diameter box
  - function list by menu, 414
- Output File
  - Tctest.Start, 352
- Output Impedance
  - Specification, 240
- Overview
  - Temperature characteristic test kit, 334
- Ovld
  - Instrument status bar, 39
  
- P**
- Pages option button
  - in Print dialog box, 189

- Parallel, 29
  - partial search area
    - setting, 153
  - Partial Search[ ] button
    - function list by menu, 394
  - Peak Delta X box
    - function list by menu, 395
  - Peak Delta Y box
    - function list by menu, 395
  - peak search, 144
  - Permeability Measurement Accuracy
    - Calculated Examples, 271, 293
  - Permeability parameters
    - Material Measurement Parameter, 263
    - Material Measurement Parameter with Temperature Measurement Test Kit, 285
    - Typical accuracy, 265, 287
    - Typical accuracy (with Option 007), 302
  - Permittivity Measurement Accuracy
    - Calculated Examples, 266, 288
  - Permittivity parameters
    - Material Measurement Parameter, 263
    - Material Measurement Parameter with Temperature Measurement Test Kit, 285
    - Typical accuracy, 264, 286
    - Typical accuracy (with Option 007), 298
  - phase
    - continuous display, 122
    - selecting unit, 123
  - Phase Unit[ ] button
    - function list by menu, 379
  - Point Average box (**Stimulus-Sweep Setup...**)
    - function list by menu, 399
  - Point Average box (**Stimulus-Sweep Setup-Segment Table Menu**)
    - function list by menu, 400
  - point averaging
    - calculation formula, 73
    - procedure, 73
  - Point Delay box
    - function list by menu, 400
  - Port extension compensation
    - Measurement Support Functions, 252
  - port extension compensation, 86
  - Power cable receptacle, 29
  - Power requirements
    - Specification, 259
  - preset
    - initialization of E4991A, 42
  - Preset (front panel key), 42
  - Preset key
    - function list by menu, 420
  - Print dialog box, 188
  - Print Graph (Color) button, 188, 236
    - function list by menu, 385
  - Print Graph (Mono) button, 188, 236
    - function list by menu, 385
  - Print List Values button, 188, 236
    - function list by menu, 385
  - Print Operating Params button, 188, 236
    - function list by menu, 385
  - Print range option button
    - in Print dialog box, 189
  - Print to file check box
    - in Print dialog box, 189
  - Print/Clipbd Menu button, 188
    - function list by menu, 384
  - PRINTER, 29
  - printer driver
    - installation, 191
  - Printer parallel port, 29
    - Specification, 255
  - printers
    - printers available, 187
  - printers available, 187
  - printing
    - how to print, 187
    - measurement list, 186
    - operating parameter list, 186
    - printing measurement graph and internal data, 186
  - printing measurement graph and internal data, 186
  - prn file
    - printing, 189
  - Probe Heads
    - Option 010 recommended, 323
  - Probe Station Connection Kit, 321
  - Probe Stations
    - Option 010 recommended, 323
  - Program Setup File Safe/Load
    - Tctest.Start, 352
  - Programming Manual, 7
  - Properties button
    - in Print dialog box, 189
- ## Q
- Q Measurement Accuracy
    - Calculated Examples, 251
  - Quick Start Guide, 7
  - Qx, 245
- ## R
- R1 box
    - function list by menu, 412
  - reading the value on trace, 128
  - rear panel
    - names and functions, 28
  - Rear Panel Connectors
    - Specification, 255
  - Recall Data button
    - function list by menu, 416
  - Recall State button
    - function list by menu, 416
  - Recover Cal/Compen State button
    - function list by menu, 405

- 
- Recovery
    - System recovery, 312
    - tctest.lcr, 375
  - RecoveryÅSample programÅtctest.lcr), 375
  - Red box
    - function list by menu, 386
  - Ref Oven, 29
  - Ref Pos box, 109
    - function list by menu, 380
  - Ref Val box, 109
    - function list by menu, 380
  - Ref X box
    - function list by menu, 382
  - Ref Y box
    - function list by menu, 382
  - Reference button
    - function list by menu, 392
  - Reference Line button, 110
  - Remote Setup Dialog button
    - function list by menu, 418
  - Reserved ports, 31
  - RI
    - CITIfile, 180
  - Right button
    - function list by menu, 393
  - rotary knob, 25
  
  - S**
  - S[1,1]
    - CITIfile, 180
  - S[1,2]
    - CITIfile, 180
  - S[2,1]
    - CITIfile, 180
  - S[2,2]
    - CITIfile, 180
  - safe mode, 23
  - Safety
    - Specification, 258, 259
  - safety
    - symbols, 4
  - safety summary, 3
  - Sample program
    - Acquiring temperature compensation data, 346
    - Execution of temperature compensation, 343
  - save and recall
    - Overview, 166
  - Save Data button
    - function list by menu, 416
  - Save Display Information, 183
  - Save Graphics, 183
  - Save Graphics button
    - function list by menu, 416
  - Save Program button
    - function list by menu, 411
  - Save State button, 169
    - function list by menu, 416
  - Save State dialog box, 169
  - Save/Recall dialog box operation, 169
  - Save/Recall key
    - function list by menu, 416
  - Saved/Recalled
    - Settings, 440
  - saving and recalling
    - Overview, 166
  - saving and recalling internal data, 165
  - saving binary data, 172
  - saving setting states, 169
  - Scalar 1
    - function list by menu, 378
  - Scalar 2
    - function list by menu, 378
  - Scalar 3
    - function list by menu, 378
  - scale
    - auto adjustment, 107
    - manual setting, 108
  - Scale box (when display is complex plain format)
    - function list by menu, 382
  - Scale box (when display is polar format)
    - function list by menu, 381
  - Scale Entry [Scale/Ref/Top/Bottom] Bottom, 109
  - Scale For box
    - function list by menu, 380
  - Scale key (when display format is linear)
    - function list by menu, 380
  - Scale key (when display is complex plain format)
    - function list by menu, 382
  - Scale key (when display is log format)
    - function list by menu, 381
  - Scale key (when display is polar format)
    - function list by menu, 381
  - Scale key (when display is Smith/Admittance chart format)
    - function list by menu, 382
  - Scale menu, 380
  - Scale reference line value
    - LCD Display display areas, 38
  - search
    - max. value, 140
    - min. value, 140
    - peak search, 144
    - search target measurement value, 142
    - search tracking, 155
  - Search button
    - function list by menu, 392
  - Search Def & Range Menu button
    - function list by menu, 393
  - search for max. value, 140
  - search min. value, 140
  - Search Track[ ] button
    - function list by menu, 393
  - Search Type box
    - function list by menu, 392
  - SEG

- CITIfile, 181
- SEG\_LIST\_BEGIN
  - CITIfile, 181
- SEG\_LIST\_END
  - CITIfile, 181
- Segment Delay box
  - function list by menu, 400
- Segment Display box
  - function list by menu, 399
- Segment No. box
  - function list by menu, 400
- Segment Sweep
  - Specification, 243
- segment sweep
  - concept, 66
  - executing, 66
- Segment Table Menu button
  - function list by menu, 399
- Select Circuit[ ] button
  - function list by menu, 412
- Select Marker box (**Marker-Function-More-Limit Test Menu**)
  - function list by menu, 395
- Select Marker box (**Marker-Marker...**)
  - function list by menu, 389
- Selected Marker[ ] button
  - function list by menu, 389
- Serial number plate, 31, 308
- Set a State File
  - Tctest.Start, 359
- Set output file
  - Tctest.Start, 366
- Settings
  - Backed Up, 440
  - Saved/Recalled, 440
- Setup toolbar
  - LCD Display display areas, 35
- Short L box (**Stimulus-Cal/Compen-Cal Kit Menu**)
  - function list by menu, 407
- Short L box (**Stimulus-Cal/Compen-Compen Kit Menu**)
  - function list by menu, 408
- Short R box (**Stimulus-Cal/Compen-Cal Kit Menu**)
  - function list by menu, 407
- Short R box (**Stimulus-Cal/Compen-Compen Kit Menu**)
  - function list by menu, 408
- Simulate F-Characteristics button
  - function list by menu, 412
- Simulate F-Characteristics to All Traces button
  - function list by menu, 412
- Single button
  - function list by menu, 409
- single sweep
  - executing, 63
- Smith/Polar box, 137
  - function list by menu, 393
- Source Characteristics
  - Specification, 239
- Source key
  - function list by menu, 403
- Span box (**Stimulus-Start/Stop...**)
  - function list by menu, 398
- Specification
  - Definitions, 238
- Specifications, 237
- Standby switch, 23
- Start box (**Stimulus-Start/Stop...**)
  - function list by menu, 397
- Start box (**Stimulus-Sweep Setup-Segment Table Menu**)
  - function list by menu, 400
- Start button (**Marker-Marker-Mraker To Menu**)
  - function list by menu, 391
- Start Measurement
  - Tctest.Start, 352
- Start/Stop key
  - function list by menu, 397
- statistics data
  - display, 151
- Statistics[ ] button
  - function list by menu, 393
- Stimulus block, 24
- Stimulus box (**Marker-Function-More-Limit Test Menu**)
  - function list by menu, 395
- Stimulus box (**Marker-Marker...**)
  - function list by menu, 389
- Stimulus box (**Marker-Marker-Delta Mode Menu**)
  - function list by menu, 391
- Stimulus Display[ ] button
  - function list by menu, 398
- Stop box (**Stimulus-Start/Stop...**)
  - function list by menu, 397
- Stop box (**Stimulus-Sweep Setup-Segment Table Menu**)
  - function list by menu, 400
- Stop button (**Marker-Marker-Mraker To Menu**)
  - function list by menu, 391
- stop sweep
  - executing, 63
- subnet mask
  - Setting, 197, 314
- Svc
  - Instrument status bar, 39
- sweep area
  - selecting display, 118
  - setting, 52, 65
  - setting by marker, 54
- Sweep Average Restart button
  - function list by menu, 379
- Sweep Average[ ] button
  - function list by menu, 379
- Sweep Conditions
  - Specification, 243
- Sweep Delay box
  - function list by menu, 400
- sweep direction
  - selecting, 49

- 
- Sweep Direction[ ] button
    - function list by menu, 399
  - Sweep key
    - function list by menu, 399
  - sweep parameter
    - selecting, 46
  - Sweep Parameter box
    - function list by menu, 399
  - Sweep start value
    - LCD Display display areas, 38
  - Sweep stop value
    - LCD Display display areas, 38
  - Sweep Time box
    - function list by menu, 400
  - Sweep Time[ ] button (**Stimulus-Sweep Setup...**)
    - function list by menu, 399
  - Sweep Time[ ] button (**Stimulus-Sweep Setup-Sweep Time[ ]**)
    - function list by menu, 400
  - sweep type
    - setting, 48
  - Sweep Type box
    - function list by menu, 399
  - sweep-to-sweep averaging
    - calculation formula, 71
  - Swp Avg Count box
    - function list by menu, 379
  - System block, 26
  - System key
    - function list by menu, 418
  - system program
    - how to shut down, 197, 314
  - System Recovery
    - How to Execute, 204
  - System recovery, 312
- T**
- target search, 142
  - Target Value box
    - function list by menu, 394
  - tctest.lcr, 351
    - How to modify, 371
    - How to use, 351
    - Recovery, 375
  - Tctest.Start, 351
    - Execute of temperature compensation, 363
    - Load temperature compensation data, 364
    - Main Menu, 352
    - Measurement Conditions, 352
    - Output File, 352
    - Program Setup File Save/Load, 352
    - Set a State File, 359
    - Set Output File, 366
    - Start Measurement, 352
    - Temp Change Compensation, 352
    - Temperature Profile
      - Change temperature arbitrary, 357
      - Change temperature stepwise, 356
      - Tuning on/off the temperature compensation data, 364
  - Temp Change Compensation
    - Tctest.Start, 352
  - Temp Change Compensation(Tctest.Start)
    - Acquire temperature compensation data, 361
  - TempComp.bas, 343
  - Temperature Characteristic Measurement
    - Accuracy, 276
    - Specification, 276
  - Temperature characteristic test kit, 333
    - Calibration/compensation, 340
    - Installation, 335
    - Overview, 334
    - Temperature compensation, 341
  - Temperature compensation, 341
  - Temperature compensation data file
    - Format, 345
  - Temperature Measurement Accuracy
    - typical, 282
  - Temperature Profile, 356, 358
    - Format, 358
  - Temperature Profile File, 361
  - Test fixture stand (option 007), 337
  - Test Head Dimensions
    - Specifications and Supplemental Information, 261
  - Test head holder (option 007), 336
  - Test head interface, 26
  - Test head stand (option 007), 336
  - Test Marker[ ] button
    - function list by menu, 395
  - Test Ports
    - Maintenance, 434
  - Thickness box (**Stimulus-Cal/Compen-Cal Kit Menu**)
    - function list by menu, 408
  - Thickness box (**Utility-Utility-Material Option Menu**)
    - function list by menu, 413
  - title
    - trace title, 124
  - Title bar
    - LCD Display display areas, 32
  - Title button
    - function list by menu, 384
  - Toolbar Off
    - function list by menu, 418
  - Top box, 109
  - Top box (when display format is linear)
    - function list by menu, 380
  - Top box (when display is log format)
    - function list by menu, 381
  - trace
    - Average, standard deviation, p-p, 151
    - comparison and operation, 116
    - setting types and numbers, 96
    - zooming, 113
  - Trace 1
    - LCD Display display areas, 38
-

Trace 2  
  LCD Display display areas, 38  
Trace Data  
  in Contents check box, 172  
Trace key  
  function list by menu, 378  
Trace Memory  
  in Contents check box, 172  
Trace menu, 378  
Trigger  
  Specification, 253  
trigger event  
  selecting, 62  
Trigger Event box  
  function list by menu, 409  
Trigger key  
  function list by menu, 409  
Trigger Polarity[ ] button  
  function list by menu, 409  
Trigger Setup key  
  function list by menu, 409  
trigger source  
  selecting, 61  
Trigger Source box  
  function list by menu, 409  
Tuning on/off the temperature compensation data  
  Tctest.Start, 364  
typeface conventions, 6  
Typical  
  Definitions, 238  
Typical Measurement Accuracy  
  Material Measurement with Temperature Measurement Test  
  Kit, 285  
Typical measurement accuracy  
  Temperature dependence effects (Option 007), 283

## U

Unused ports, 31  
Upper box  
  function list by menu, 395  
USB ports, 30  
User-defined point mode  
  Calibration/Compensation data measurement point, 252  
Utility key, 26  
  function list by menu, 411

## V

VAR  
  CITIfile keyword, 180  
version number  
  CITIfile, 180  
VIDEO, 29  
Visual Basic Editor button  
  function list by menu, 411

## W

warranty, 5  
  limitation of, 5  
Weight  
  Specification, 259  
Window Maximize button  
  function list by menu, 384  
Window Restore button  
  function list by menu, 384  
Windows or OS/2 Bitmap format  
  Save Display Information, 183

## Y

|Y| Measurement Accuracy  
  Calculated Examples, 247  
  Calculated Examples (Option 007), 278  
Yo, 246  
Yo (Option 007), 277

## Z

|Z| Measurement Accuracy  
  Calculated Examples, 247  
  Calculated Examples (Option 007), 278  
Zero Span sweep  
  setting, 47  
zooming  
  zooming of trace, 113  
Zs, 246  
Zs (Option 007), 277