

# Agilent E4991A RF Impedance/Material Analyzer

Data Sheet



**Agilent Technologies**

## Definitions

All specifications apply over a 5 °C to 40 °C range (unless otherwise stated) and 30 minutes after the instrument has been turned on.

### Specification (spec.)

Warranted performance. Specifications include guardbands to account for the expected statistical performance distribution, measurement uncertainties, and changes in performance due to environmental conditions.

Supplemental information is intended to provide information useful in applying the instrument, but that is not covered by the product warranty. The information is denoted as typical, or nominal.

### Typical (typ.)

Expected performance of an average unit which does not include guardbands. It is not covered by the product warranty.

### Nominal (nom.)

A general, descriptive term that does not imply a level of performance. It is not covered by the product warranty.

## Measurement Parameters and Range

### Measurement parameters

#### Impedance parameters:

$|Z|$ ,  $|Y|$ ,  $L_S$ ,  $L_P$ ,  $C_S$ ,  $C_P$ ,  $R_S(R)$ ,  $R_P$ ,  $X$ ,  $G$ ,  $B$ ,  $D$ ,  $Q$ ,  $\theta_Z$ ,  
 $\theta_Y$ ,  $|\Gamma|$ ,  $\Gamma_X$ ,  $\Gamma_Y$ ,  $\theta_V$

#### Material parameters (option E4991A-002):

(see "Option E4991A-002 material measurement (typical)" on page 17)

Permittivity parameters:  $|\epsilon_r|$ ,  $\epsilon_r'$ ,  $\epsilon_r''$ ,  $\tan\delta$

Permeability parameters:  $|\mu_r|$ ,  $\mu_r'$ ,  $\mu_r''$ ,  $\tan\delta$

### Measurement range

#### Measurement range ( $|Z|$ ):

130 m $\Omega$  to 20 k $\Omega$ .

(Frequency = 1 MHz,

Point averaging factor  $\geq 8$ ,

Oscillator level = -3 dBm; = -13 dBm; or = -23 dBm,

Measurement accuracy  $\leq \pm 10\%$ ,

Calibration is performed within 23 °C  $\pm$  5 °C,

Measurement is performed within  $\pm 5$  °C of calibration temperature)

## Source Characteristics

### Frequency

**Range:** 1 MHz to 3 GHz

**Resolution:** 1 mHz

**Accuracy:**

without Option E4991A-1D5:

±10 ppm (23 °C ±5 °C)

±20 ppm (5 °C to 40 °C)

with Option E4991A-1D5:

±1 ppm (5 °C to 40 °C)

**Stability:**

with Option E4991A-1D5:

±0.5 ppm/year (5 °C to 40 °C)(typical)

### Oscillator level

**Range:**

Power (when 50 Ω load is connected to test port):

–40 dBm to 1 dBm (frequency ≤ 1 GHz)

–40 dBm to 0 dBm (frequency > 1 GHz<sup>1</sup>)

Current (when short is connected to test port):

0.0894 mArms to 10 mArms (frequency ≤ 1 GHz)

0.0894 mArms to 8.94 mArms (frequency > 1 GHz<sup>1</sup>)

Voltage (when open is connected to test port):

4.47 mVrms to 502 mVrms (frequency ≤ 1 GHz)

4.47 mVrms to 447 mVrms (frequency > 1 GHz<sup>1</sup>)

**Resolution:** 0.1 dB<sup>2</sup>

**Accuracy:**

(Power, when 50 Ω load is connected to test port)

Frequency ≤ 1 GHz:

±2 dB (23 °C ±5 °C)

±4 dB (5 °C to 40 °C)

Frequency > 1 GHz:

±3 dB (23 °C ±5 °C)

±5 dB (5 °C to 40 °C)

with Option E4991A-010:

Frequency ≤ 1 GHz

±3.5 dB (23 °C ± 5 °C)

±5.5 dB (5 °C to 40 °C)

Frequency > 1 GHz

±5.6 dB (23 °C ± 5 °C)

±7.6 dB (5 °C to 40 °C)

### Output impedance

**Output impedance:** 50 Ω (nominal)

## DC Bias (Option E4991A-001)

### DC voltage bias

**Range:** 0 to ±40 V

**Resolution:** 1 mV

**Accuracy:**

±{0.1% + 6 mV + (Idc[mA] × 20 Ω)[mV]}  
(23 °C ±5 °C)

±{0.2% + 12 mV + (Idc[mA] × 40 Ω)[mV]}  
(5 °C to 40 °C)

### DC current bias

**Range:** 100 μA to 50 mA, –100 μA to –50 mA

**Resolution:** 10 μA

**Accuracy:**

±{0.2% + 20 μA + (Vdc[V] / 10 kΩ)[mA]}  
(23 °C ±5 °C)

±{0.4% + 40 μA + (Vdc[V] / 5 kΩ)[mA]}  
(5 °C to 40 °C)

### DC bias monitor

**Monitor parameters:** Voltage and current

**Voltage monitor accuracy:**

±{0.5% + 15 mV + (Idc[mA] × 2 Ω)[mV]}  
(23 °C ±5 °C, typical)

±{1.0% + 30 mV + (Idc[mA] × 4 Ω)[mV]}  
(5 °C to 40 °C, typical)

**Current monitor accuracy:**

±{0.5% + 30 μA + (Vdc[V] / 40 k Ω)[mA]}  
(23 °C ±5 °C, typical)

±{1.0% + 60 μA + (Vdc[V] / 20 k Ω)[mA]}  
(5 °C to 40 °C, typical)

1. It is possible to set more than 0 dBm (447 mV, 8.94 mA) oscillator level at frequency > 1 GHz. However, the characteristics at this setting are not guaranteed.

2. When the unit is set at mV or mA, the entered value is rounded to 0.1 dB resolution.

# Probe Station Connection Kit (Option E4991A-010)

## Oscillator level

### Power accuracy:

- Frequency  $\leq 1$  GHz:  
 $\pm 5.5$  dB (5 °C to 40 °C)
- Frequency  $> 1$  GHz:  
 $\pm 7.6$  dB (5 °C to 40 °C)

## Sweep Characteristics

### Sweep conditions

#### Sweep parameters:

Frequency, oscillator level (power, voltage, current), DC bias voltage, DC bias current

**Sweep range setup:** Start/stop or center/span

#### Sweep types:

**Frequency sweep:** linear, log, segment  
**Other parameters sweep:** linear, log

**Sweep mode:** Continuous, single

#### Sweep directions:

**Oscillator level, DC bias (voltage and current):** up sweep, down sweep  
**Other parameters sweep:** up sweep

**Number of measurement points:** 2 to 801

#### Delay time:

**Types:** point delay, sweep delay, segment delay  
**Range:** 0 to 30 sec  
**Resolution:** 1 msec

### Segment sweep

#### Available setup parameters for each segment:

Sweep frequency range, number of measurement points, point averaging factor, oscillator level (power, voltage, or current), DC bias (voltage or current), DC bias limit (current limit for voltage bias, voltage limit for current bias)

**Number of segments:** 1 to 16

**Sweep span types:** Frequency base or order base

## Measurement Accuracy

### Conditions for defining accuracy

**Temperature:** 23 °C  $\pm 5$  °C

**Accuracy-specified plane:** 7-mm connector of test head

### Accuracy defined measurement points:

Same points at which the calibration is done.

### Accuracy when open/short/load calibration is performed

<b> Z ,  Y :</b>	$\pm(E_a + E_b)$ [%] (see Figures 1 through 4 for examples of calculated accuracy)
<b><math>\theta</math>:</b>	$\pm \frac{(E_a + E_b)}{100}$ [rad]
<b>L, C, X, B:</b>	$\pm (E_a + E_b) \times \sqrt{(1 + D_x^2)}$ [%]
<b>R, G:</b>	$\pm (E_a + E_b) \times \sqrt{(1 + Q_x^2)}$ [%]
<b>D:</b>	$\pm \frac{(1 + D_x^2) \tan \left( \frac{E_a + E_b}{100} \right)}{1 \mp D_x \tan \left( \frac{E_a + E_b}{100} \right)}$
at $\left  D_x \tan \left( \frac{E_a + E_b}{100} \right) \right  < 1$	
at $D_x \leq 0.1$	$\pm \frac{E_a + E_b}{100}$
<b>Q:</b>	$\pm \frac{(1 + Q_x^2) \tan \left( \frac{E_a + E_b}{100} \right)}{1 \mp Q_x \tan \left( \frac{E_a + E_b}{100} \right)}$
at $\left  Q_x \tan \left( \frac{E_a + E_b}{100} \right) \right  < 1$	
at $\frac{10}{E_a + E_b} \geq Q_x \geq 10$	$\pm Q_x^2 \frac{E_a + E_b}{100}$

**Accuracy when open/short/load/low-loss capacitor calibration is performed  
(Point averaging factor  $\geq 8$ , typical)**

$$|Z|, |Y|: \quad \pm(E_a + E_b) [\%]$$

$$\theta: \quad \pm \frac{E_c}{100} [\text{rad}]$$

$$\mathbf{L}, \mathbf{C}, \mathbf{X}, \mathbf{B}: \quad \pm \sqrt{(E_a + E_b)^2 + (E_c D_x)^2} [\%]$$

$$\mathbf{R}, \mathbf{G}: \quad \pm \sqrt{(E_a + E_b)^2 + (E_c Q_x)^2} [\%]$$

$$\mathbf{D}: \quad \text{at } \left| D_x \tan \left( \frac{E_c}{100} \right) \right| < 1 \quad \pm \frac{(1 + D_x^2) \tan \left( \frac{E_c}{100} \right)}{1 \mp D_x \tan \left( \frac{E_c}{100} \right)}$$

$$\text{at } D_x \leq 0.1 \quad \pm \frac{E_c}{100}$$

$$\mathbf{Q}: \quad \text{at } \left| Q_x \tan \left( \frac{E_c}{100} \right) \right| < 1 \quad \pm \frac{(1 + Q_x^2) \tan \left( \frac{E_c}{100} \right)}{1 \mp Q_x \tan \left( \frac{E_c}{100} \right)}$$

$$\text{at } \frac{10}{E_c} \geq Q_x \geq 10 \quad \pm Q_x^2 \frac{E_c}{100}$$

(See Figure 5)

**Definition of each parameter**

**D<sub>x</sub>** = Measurement value of D

**Q<sub>x</sub>** = Measurement value of Q

**E<sub>a</sub>** = (Within  $\pm 5$  °C from the calibration temperature. Measurement accuracy applies when the calibration is performed at 23 °C  $\pm 5$  °C. When the calibration is performed beyond 23 °C  $\pm 5$  °C, measurement error doubles.)

**at oscillator level  $\geq -33$  dBm:**

- $\pm 0.65$  [%] (1 MHz  $\leq$  Frequency  $\leq$  100 MHz)
- $\pm 0.8$  [%] (100 MHz  $<$  Frequency  $\leq$  500 MHz)
- $\pm 1.2$  [%] (500 MHz  $<$  Frequency  $\leq$  1 GHz)
- $\pm 2.5$  [%] (1 GHz  $<$  Frequency  $\leq$  1.8 GHz)
- $\pm 5$  [%] (1.8 GHz  $<$  Frequency  $\leq$  3 GHz)

**at oscillator level  $< -33$  dBm:**

- $\pm 1$  [%] (1 MHz  $\leq$  Frequency  $\leq$  100 MHz)
- $\pm 1.2$  [%] (100 MHz  $<$  Frequency  $\leq$  500 MHz)
- $\pm 1.2$  [%] (500 MHz  $<$  Frequency  $\leq$  1 GHz)
- $\pm 2.5$  [%] (1 GHz  $<$  Frequency  $\leq$  1.8 GHz)
- $\pm 5$  [%] (1.8 GHz  $<$  Frequency  $\leq$  3 GHz)

$$\mathbf{E}_b = \pm \left[ \frac{Z_s}{|Z_x|} + Y_o \cdot |Z_x| \right] \times 100 [\%]$$

( $|Z_x|$ : measurement value of  $|Z|$ )

$$\mathbf{E}_c = \pm \left[ 0.06 + \frac{0.08 \times F}{1000} \right] [\%]$$

(F: frequency [MHz], typical)

**Z<sub>s</sub>** = (Within  $\pm 5$  °C from the calibration temperature. Measurement accuracy applies when the calibration is performed at 23 °C  $\pm 5$  °C. When the calibration is performed beyond 23 °C  $\pm 5$  °C, the measurement accuracy decreases to half that described.

F: frequency [MHz].)

**at oscillator level = -3 dBm, -13 dBm, or -23 dBm:**

- $\pm (13 + 0.5 \times F)$  [m $\Omega$ ] (averaging factor  $\geq 8$ )
- $\pm (25 + 0.5 \times F)$  [m $\Omega$ ] (averaging factor  $\leq 7$ )

**at oscillator level  $\geq -33$  dBm**

- $\pm (25 + 0.5 \times F)$  [m $\Omega$ ] (averaging factor  $\geq 8$ )
- $\pm (50 + 0.5 \times F)$  [m $\Omega$ ] (averaging factor  $\leq 7$ )

**at oscillator level  $< -33$  dBm**

- $\pm (50 + 0.5 \times F)$  [m $\Omega$ ] (averaging factor  $\geq 8$ )
- $\pm (100 + 0.5 \times F)$  [m $\Omega$ ] (averaging factor  $\leq 7$ )

**Y<sub>o</sub>** = (Within  $\pm 5$  °C from the calibration temperature.

Measurement accuracy applies when the calibration is performed at 23 °C  $\pm 5$  °C. When the calibration is performed beyond 23 °C  $\pm 5$  °C, the measurement accuracy decreases to half that described. F: frequency [MHz].)

**at oscillator level = -3 dBm, -13 dBm, -23 dBm:**

- $\pm (5 + 0.1 \times F)$  [ $\mu$ S] (averaging factor  $\geq 8$ )
- $\pm (10 + 0.1 \times F)$  [ $\mu$ S] (averaging factor  $\leq 7$ )

**at oscillator level  $\geq -33$  dBm:**

- $\pm (10 + 0.1 \times F)$  [ $\mu$ S] (averaging factor  $\geq 8$ )
- $\pm (30 + 0.1 \times F)$  [ $\mu$ S] (averaging factor  $\leq 7$ )

**at oscillator level  $< -33$  dBm**

- $\pm (20 + 0.1 \times F)$  [ $\mu$ S] (averaging factor  $\geq 8$ )
- $\pm (60 + 0.1 \times F)$  [ $\mu$ S] (averaging factor  $\leq 7$ )

# Measurement Accuracy *(continued)*

## Calculated impedance measurement accuracy

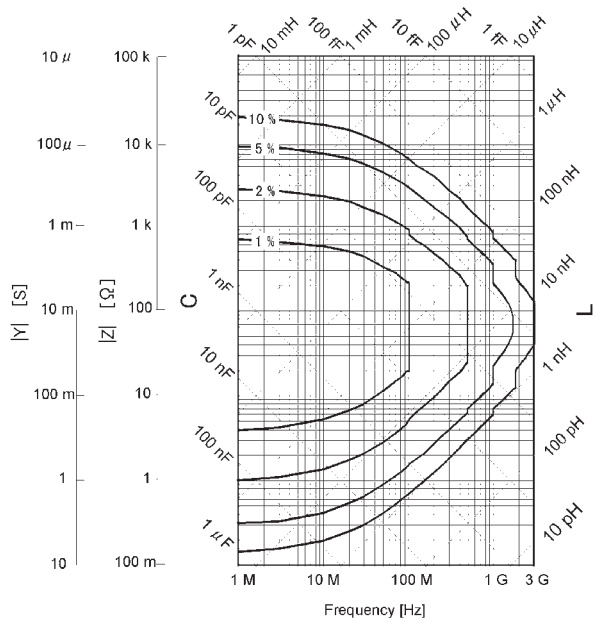

**Figure 1.**  $|Z|$ ,  $|Y|$  Measurement accuracy when open/short/load calibration is performed. Oscillator level =  $-23$  dBm,  $-13$  dBm,  $-3$  dBm. Point averaging factor  $\geq 8$  within  $\pm 5$   $^{\circ}$ C from the calibration temperature.

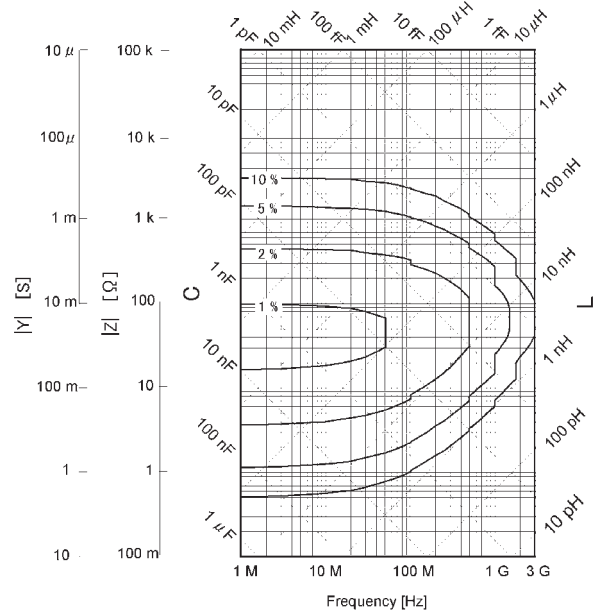

**Figure 3.**  $|Z|$ ,  $|Y|$  Measurement accuracy when open/short/load calibration is performed. Oscillator level  $\geq -33$  dBm. Point averaging factor  $\leq 7$  within  $\pm 5$   $^{\circ}$ C from the calibration temperature.

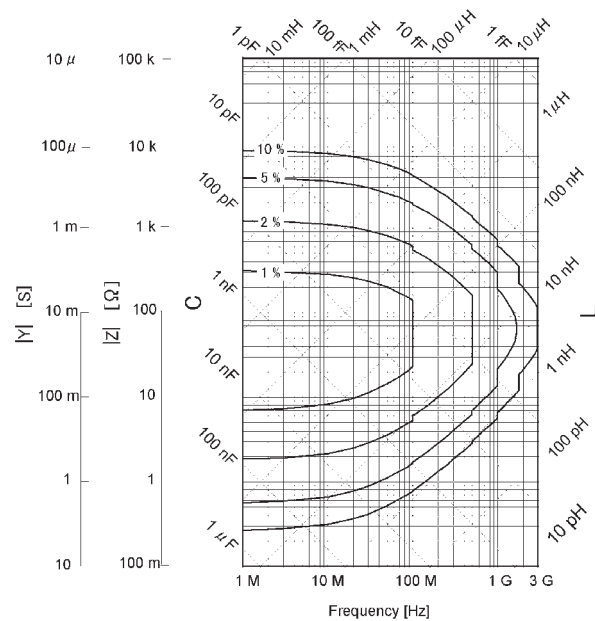

**Figure 2.**  $|Z|$ ,  $|Y|$  Measurement accuracy when open/short/load calibration is performed. Oscillator level  $\geq -33$  dBm. Point averaging factor  $\geq 8$  within  $\pm 5$   $^{\circ}$ C from the calibration temperature.

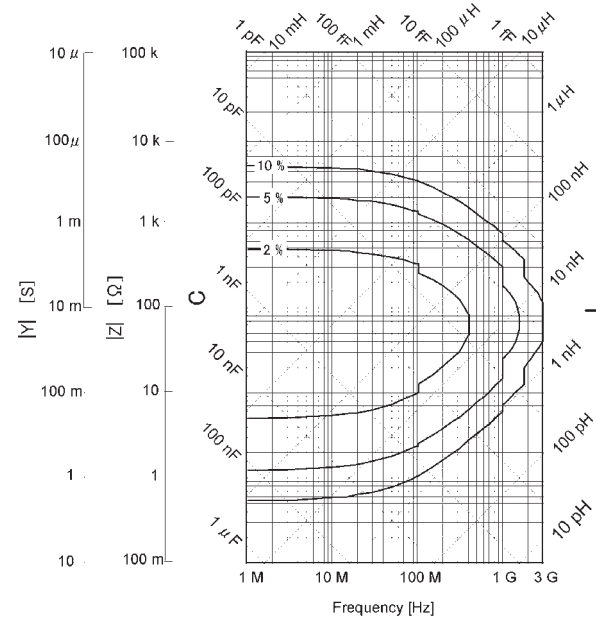

**Figure 4.**  $|Z|$ ,  $|Y|$  Measurement accuracy when open/short/load calibration is performed. Oscillator level  $< -33$  dBm within  $\pm 5$   $^{\circ}$ C from the calibration temperature.

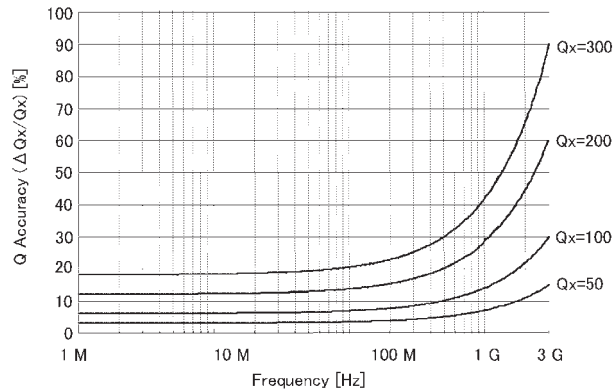

**Figure 5. Q Measurement accuracy when open/short/load/low-loss capacitor calibration is performed (typical).**

## Measurement Support Functions

### Error correction

#### Available calibration and compensation

##### Open/short/load calibration:

Connect open, short, and load standards to the desired reference plane and measure each kind of calibration data. The reference plane is called the calibration reference plane.

##### Low-loss capacitor calibration:

Connect the dedicated standard (low-loss capacitor) to the calibration reference plane and measure the calibration data.

##### Port extension compensation (fixture selection):

When a device is connected to a terminal that is extended from the calibration reference plane, set the electrical length between the calibration plane and the device contact. Select the model number of the registered test fixtures in the E4991A's setup toolbar or enter the electrical length for the user's test fixture.

##### Open/short compensation:

When a device is connected to a terminal that is extended from the calibration reference plane, make open and/or short states at the device contact and measure each kind of compensation data.

#### Calibration/compensation data measurement point

##### User-defined point mode:

Obtain calibration/compensation data at the same frequency and power points as used in actual device measurement, which are determined by the sweep setups. Each set of calibration/compensation data is applied to each measurement at the same point. If measurement points (frequency and/or power) are changed by altering the sweep setups, calibration/compensation data become invalid and calibration or compensation data acquisition is again required.

## Measurement Support Functions *(continued)*

### Fixed frequency and fixed power point mode:

Obtain calibration/compensation data at fixed frequency and power points covering the entire frequency and power range of the E4991A. In device measurement, calibration or compensation is applied to each measurement point by using interpolation. Even if the measurement points (frequency and/or power) are changed by altering the sweep setups, you don't need to retake the calibration or compensation data.

### Fixed frequency and user-defined power point mode:

Obtain calibration/compensation data at fixed frequency points covering the entire frequency range of the E4991A and at the same power points as used in actual device measurement which are determined by the sweep setups. Only if the power points are changed, calibration/compensation data become invalid and calibration or compensation data acquisition is again required.

## Trigger

### Trigger mode:

Internal, external (external trigger input connector), bus (GPIB), manual (front key)

## Averaging

### Types:

Sweep-to-sweep averaging, point averaging

### Setting range:

**Sweep-to-sweep averaging:** 1 to 999 (integer)

**Point averaging:** 1 to 100 (integer)

## Display

### LCD display :

**Type/size:** color LCD, 8.4 inch (21.3 cm)

**Resolution:** 640 (horizontal) × 480 (vertical)

### Number of traces:

**Data trace:** 3 scalar traces + 2 complex traces (maximum)

**Memory trace:** 3 scalar traces + 2 complex traces (maximum)

### Trace data math:

Data – memory, data/memory (for complex parameters), delta% (for scalar parameters), offset

### Format:

**For scalar parameters:** linear Y-axis, log Y-axis

**For complex parameters:** Z, Y: polar, complex;  $\Gamma$ : polar, complex, Smith, admittance

### Other display functions:

Split/overlay display (for scalar parameters), phase expansion



## Marker

### Number of markers:

- Main marker:** one for each trace (marker 1)
- Sub marker:** seven for each trace (marker 2 to marker 8)
- Reference marker:** one for each trace (marker R)

### Marker search:

- Search type:** maximum, minimum, target, peak
- Search track:** performs search with each sweep

### Other functions:

- Marker continuous mode, marker coupled mode, marker list, marker statistics

## Equivalent circuit analysis

### Circuit models:

- 3-component model (4 models),
- 4-component model (1 model)

### Analysis types:

- Equivalent circuit parameters calculation, frequency characteristics simulation

## Limit marker test

### Number of markers for limit test:

- 9 (marker R, marker 1 to 8)

### Setup parameters for each marker:

- Stimulus value, upper limit, and lower limit

## Mass storage

### Built-in flexible disk drive:

- 3.5 inch, 720 KByte or 1.44 MByte, DOS format

### Hard disk drive: 2 GByte (minimum)

### Stored data:

- State (binary), measurement data (binary, ASCII or CITI file), display graphics (bmp, jpg), VBA program (binary)

## Interface

### GPIB

**Standard conformity:** IEEE 488.1-1987, IEEE 488.2-1987

### Available functions (function code)<sup>1</sup>:

- SH1, AH1, T6, TE0, L4, LE0, SR1, RLO, PP0, DT1, DC1, C0, E2

**Numerical data transfer format:** ASCII

**Protocol:** IEEE 488.2-1987

### Printer parallel port

**Interface standard:** IEEE 1284 Centronics

**Connector type:** 25-pin D-sub connector, female

### LAN interface

### Standard conformity:

- 10 Base-T or 100 Base-TX (automatically switched), Ethertwist, RJ45 connector

**Protocol:** TCP/IP

**Functions:** FTP

### USB Port

**Interface standard:** USB 1.1

**Connector type:** Standard USB A, female

### Available functions:

- Provides connection to printers and USB/GPIB Interface.

---

1. Refer to the standard for the meaning of each function code.

## Measurement Terminal (At Test Head)

**Connector type:** 7-mm connector

## Rear Panel Connectors

### External reference signal input connector

**Frequency:** 10 MHz  $\pm$ 10 ppm (typical)

**Level:** 0 dBm to +6 dBm (typical)

**Input impedance:** 50  $\Omega$  (nominal)

**Connector type:** BNC, female

### Internal reference signal output connector

**Frequency:** 10 MHz (nominal)

**Accuracy of frequency:**

Same as frequency accuracy described in  
"Frequency" on page 3

**Level:** +2 dBm (nominal)

**Output impedance:** 50  $\Omega$  (nominal)

**Connector type:** BNC, female

### High stability frequency reference output connector (Option E4991A-1D5)

**Frequency:** 10 MHz (nominal)

**Accuracy of frequency:**

Same as frequency accuracy described in  
"Frequency" on page 3

**Level:** +2 dBm (nominal)

**Output impedance:** 50  $\Omega$  (nominal)

**Connector type:** BNC, female

## External trigger input connector

### Level:

LOW threshold voltage: 0.5 V

HIGH threshold voltage: 2.1 V

Input level range: 0 V to +5 V

### Pulse width (Tp):

≥ 2 μsec (typical). See Figure 6 for definition of Tp.

**Polarity:** Positive or negative (selective)

**Connector type:** BNC, female

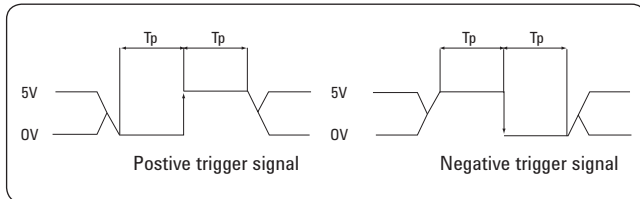

Figure 6. Definition of pulse width (Tp)

## General Characteristics

### Environment conditions

#### Operating condition

**Temperature:** 5 °C to 40 °C

#### Humidity:

(at wet bulb temperature ≤ 29 °C, without condensation)

**Flexible disk drive non-operating condition:**

15% to 90% RH

**Flexible disk drive operating condition:**

20% to 80% RH

**Altitude:** 0 m to 2,000 m (0 feet to 6,561 feet)

**Vibration:** 0.5 G maximum, 5 Hz to 500 Hz

**Warm-up time:** 30 minutes

#### Non-operating storage condition

**Temperature:** -20 °C to +60 °C

#### Humidity:

(at wet bulb temperature ≤ 45 °C, without condensation)

15% to 90% RH

**Altitude:** 0 m to 4,572 m (0 feet to 15,000 feet)

**Vibration:** 1 G maximum, 5 Hz to 500 Hz

## General Characteristics *(continued)*

### Other Specifications

#### EMC

European Council Directive 89/336/EEC



IEC 61326-1:1997+A1

CISPR 11:1990 / EN 55011:1991 Group 1, Class A

IEC 61000-4-2:1995 / EN 61000-4-2:1995

4 kV CD / 4 kV AD

IEC 61000-4-3:1995 / EN 61000-4-3:1996

3 V/m, 80-1000 MHz, 80% AM

IEC 61000-4-4:1995 / EN 61000-4-4:1995

1 kV power / 0.5 kV Signal

IEC 61000-4-5:1995 / EN 61000-4-5:1995

0.5 kV Normal / 1 kV Common

IEC 61000-4-6:1996 / EN 61000-4-6:1996

3 V, 0.15-80 MHz, 80% AM

IEC 61000-4-11:1994 / EN 61000-4-11:1994

100% 1cycle

**Note:** When tested at 3 V/m according to EN 61000-4-3:1996, the measurement accuracy will be within specifications over the full immunity test frequency range of 80 MHz to 1000 MHz except when the analyzer frequency is identical to the transmitted interference signal test frequency.



AS/NZS 2064.1/2 Group 1, Class A

#### Safety



European Council Directive 73/23/EEC

IEC 61010-1:1990+A1+A2 / EN 61010-1:1993+A2

INSTALLATION CATEGORY II, POLLUTION

DEGREE 2

INDOOR USE

IEC60825-1:1994 CLASS 1 LED PRODUCT



CAN/CSA C22.2 No. 1010.1-92

#### Power requirements

90 V to 132 V, or 198 V to 264 V (automatically switched),  
47 Hz to 63 Hz, 350 VA maximum

#### Weight

Main unit: 17 kg (nominal)

Test head: 1 kg (nominal)

#### Dimensions

Main unit: See Figure 7 through Figure 9

Test head: See Figure 10

Option E4991A-007 test head dimensions: See Figure 11

Option E4991A-010 test head dimensions: See Figure 12

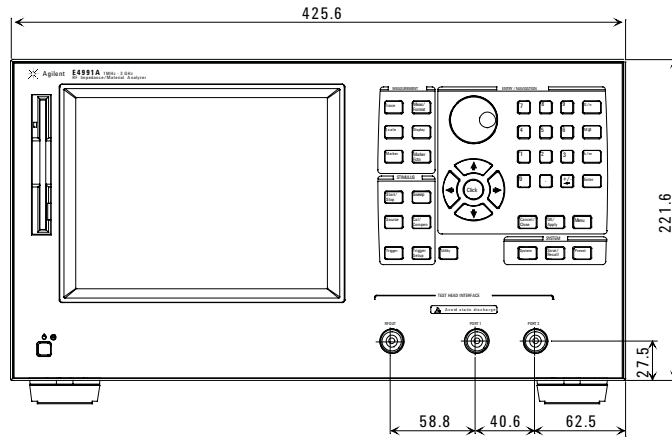

Figure 7. Main unit dimensions (front view, in millimeters, nominal)

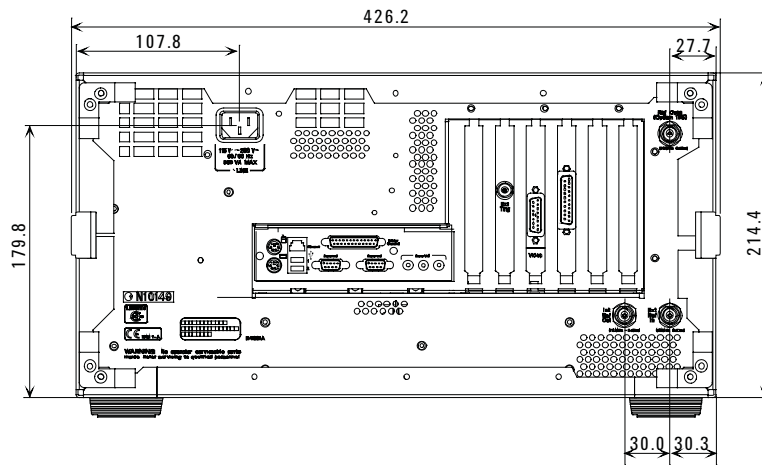

Figure 8. Main unit dimensions (rear view, in millimeters, nominal)

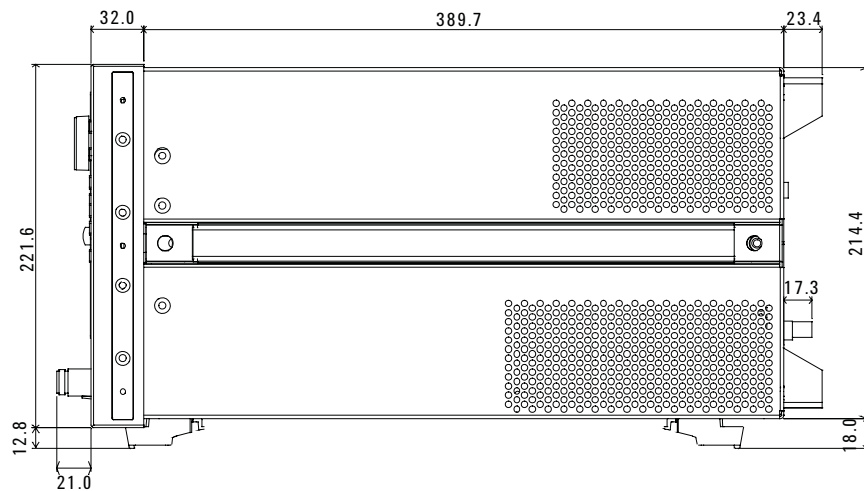
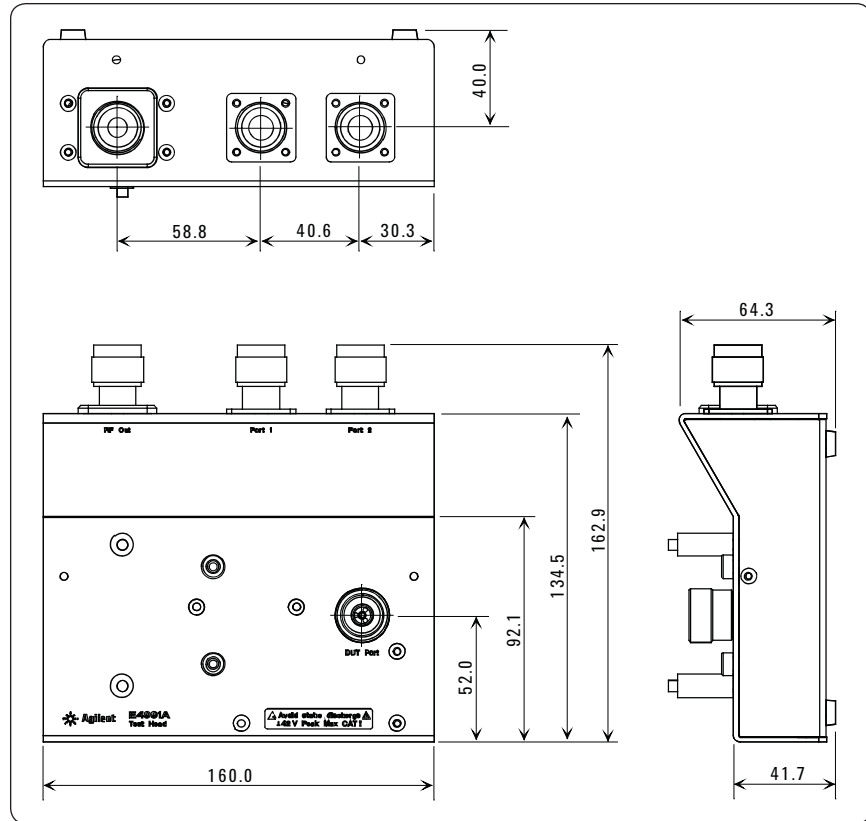
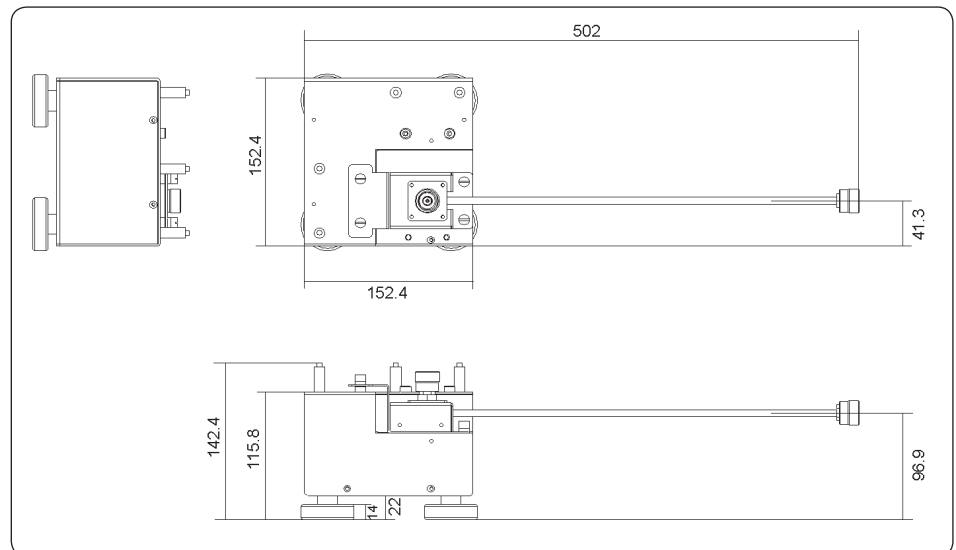

Figure 9. Main unit dimensions (side view, in millimeters, nominal)

## General Characteristics *(continued)*



**Figure 10. Test head dimensions (in millimeters, nominal)**



**Figure 11. Option E4991A-007 test head dimensions (in millimeters, nominal)**

## General Characteristics *(continued)*

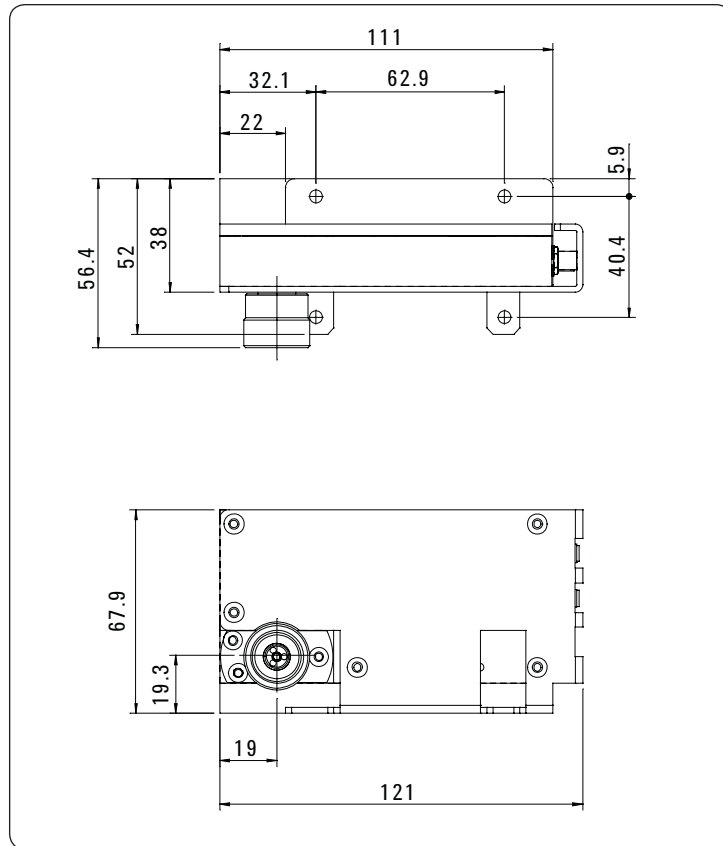

Figure 12. Option E4991A-010 test head dimensions (in millimeters, nominal)

## Furnished accessories

<b>Model/option number</b>	<b>Description</b>	<b>Quantity</b>
Agilent E4991A	Agilent E4991A impedance/material analyzer (main unit)	1
	Test head	1
	Agilent 16195B 7-mm calibration kit	1
	Torque wrench	1
	E4991A recovery disk	1
	Power cable	1
	CD-ROM (English/Japanese PDF manuals) <sup>1</sup>	1

---

1. The CD-ROM includes an operation manual, an installation and quick start guide, and a programming manual. A service manual is not included.



## Option E4991A-002 Material Measurement (Typical)

### Measurement parameter

**Permittivity parameters:**  $|\epsilon_r|$ ,  $\epsilon_r'$ ,  $\epsilon_r''$ ,  $\tan\delta$

**Permeability parameters:**  $|\mu_r|$ ,  $\mu_r'$ ,  $\mu_r''$ ,  $\tan\delta$

### Frequency range

**Using with Agilent 16453A:** 1 MHz to 1 GHz (typical)

**Using with Agilent 16454A:** 1 MHz to 1 GHz (typical)

### Measurement accuracy

#### Conditions for defining accuracy:

##### Calibration:

Open, short, and load calibration at the test port  
(7-mm connector)

##### Calibration temperature:

Calibration is performed at an environmental temperature within the range of  $23\text{ °C} \pm 5\text{ °C}$ .

Measurement error doubles when calibration temperature is below  $18\text{ °C}$  or above  $28\text{ °C}$ .

##### Temperature:

Temperature deviation: within  $\pm 5\text{ °C}$  from the calibration temperature

Environment temperature: Measurement accuracy applies when the calibration is performed at  $23\text{ °C} \pm 5\text{ °C}$ . When the calibration is below  $18\text{ °C}$  or above  $23\text{ °C}$ , measurement error doubles.

##### Measurement frequency points:

Same as calibration points

**Oscillator level:** Same as the level set at calibration

**Point averaging factor:**  $\geq 8$

**Electrode pressure setting of 16453A:** maximum

#### Typical accuracy of permittivity parameters:

$$\epsilon_r' \text{ accuracy } \left[ = \frac{\Delta\epsilon'_{rm}}{\epsilon'_{rm}} \right]:$$

$$\pm \left[ 5 + \left( 10 + \frac{0.1}{f} \right) \frac{t}{\epsilon'_{rm}} + 0.25 \frac{\epsilon'_{rm}}{t} + \frac{100}{\left| 1 - \left( \frac{13}{f \sqrt{\epsilon'_{rm}}} \right)^2 \right|} \right] [\%]$$

(at  $\tan\delta < 0.1$ )

Loss tangent accuracy of  $\epsilon_r$  ( $= \Delta\tan\delta$ ):

$$\pm(E_a + E_b) \text{ (at } \tan\delta < 0.1)$$

where,

$$E_a =$$

at Frequency  $\leq 1\text{ GHz}$ :

$$0.002 + \frac{0.001}{f} \cdot \frac{t}{\epsilon'_{rm}} + 0.004f + \frac{0.1}{\left| 1 - \left( \frac{13}{f \sqrt{\epsilon'_{rm}}} \right)^2 \right|}$$

$$E_b = \left( \frac{\Delta\epsilon'_{rm}}{\epsilon'_{rm}} \cdot \frac{1}{100} + \epsilon'_{rm} \frac{0.002}{t} \right) \tan\delta$$

$f$  = Measurement frequency [GHz]

$t$  = Thickness of MUT (material under test) [mm]

$\epsilon'_{rm}$  = Measured value of  $\epsilon'_r$

$\tan\delta$  = Measured value of dielectric loss tangent

**Typical accuracy of permeability parameters:**

$\mu_r'$  accuracy

$$\left( = \frac{\Delta\mu'_{rm}}{\mu'_{rm}} \right):$$
$$4 + \frac{0.02}{f} \times \frac{25}{F\mu'_{rm}} + F\mu'_{rm} \left( 1 + \frac{15}{F\mu'_{rm}} \right)^2 f^2 [\%]$$

(at  $\tan\delta < 0.1$ )

Loss tangent accuracy of  $\mu_r$  ( $= \Delta\tan\delta$ ):

$$\pm(E_a + E_b) \text{ (at } \tan\delta < 0.1)$$

where,

$$E_a = 0.002 + \frac{0.001}{F\mu'_{rm} f} + 0.004 f$$

$$E_b = \frac{\Delta\mu'_{rm}}{\mu'_{rm}} \cdot \frac{\tan\delta}{100}$$

$f$  = Measurement frequency [GHz]

$F$  =  $h \ln \frac{c}{b}$  [mm]

$h$  = Height of MUT (material under test) [mm]

$b$  = Inner diameter of MUT (material under test) [mm]

$c$  = Outer diameter of MUT (material under test) [mm]

$\mu'_{rm}$  = Measured value of  $\mu_r'$

$\tan\delta$  = Measured value of loss tangent

## Option E4991A-002 Material Measurement (typical) (continued)

Examples of calculated permittivity measurement accuracy

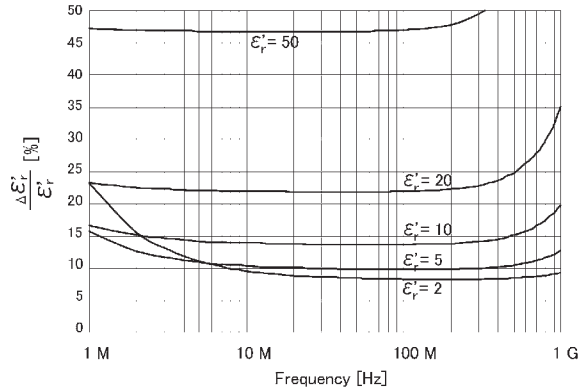

Figure 13. Permittivity accuracy  $\left(\frac{\Delta \epsilon'_r}{\epsilon'_r}\right)$  vs. frequency (at  $t = 0.3$  mm, typical)

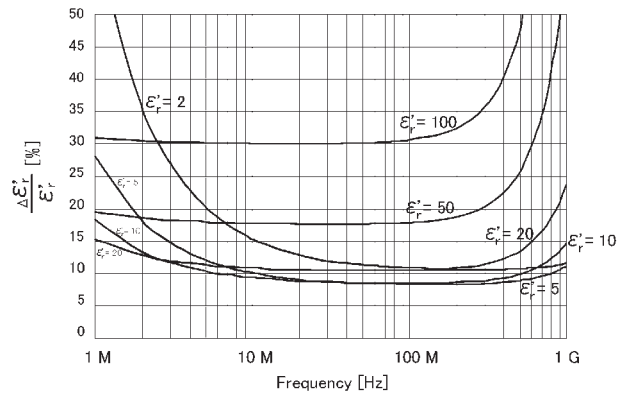

Figure 14. Permittivity accuracy  $\left(\frac{\Delta \epsilon'_r}{\epsilon'_r}\right)$  vs. frequency (at  $t = 1$  mm, typical)

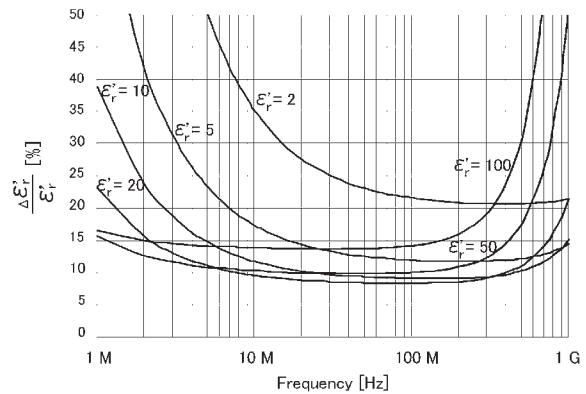

Figure 15. Permittivity accuracy  $\left(\frac{\Delta \epsilon'_r}{\epsilon'_r}\right)$  vs. frequency (at  $t = 3$  mm, typical)

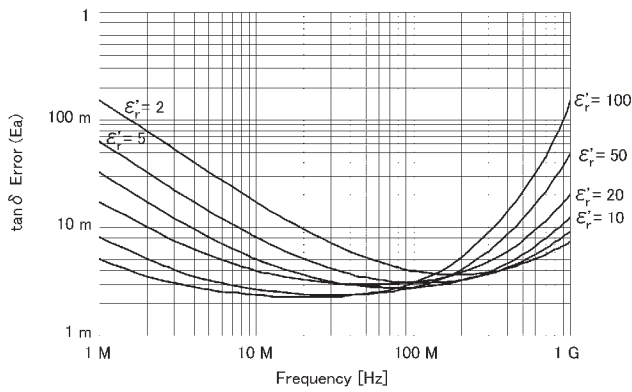

Figure 16. Dielectric loss tangent ( $\tan\delta$ ) accuracy vs. frequency (at  $t = 0.3$  mm, typical)<sup>1</sup>

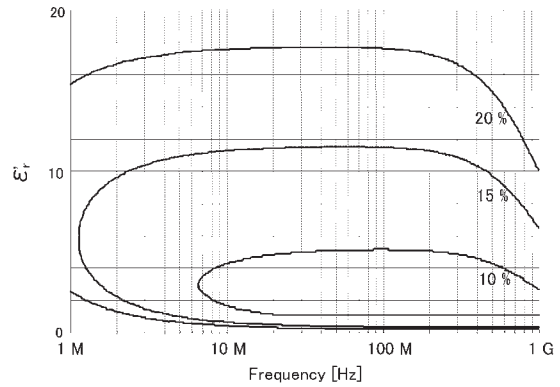

Figure 19. Permittivity ( $\epsilon_r'$ ) vs. frequency (at  $t = 0.3$  mm, typical)

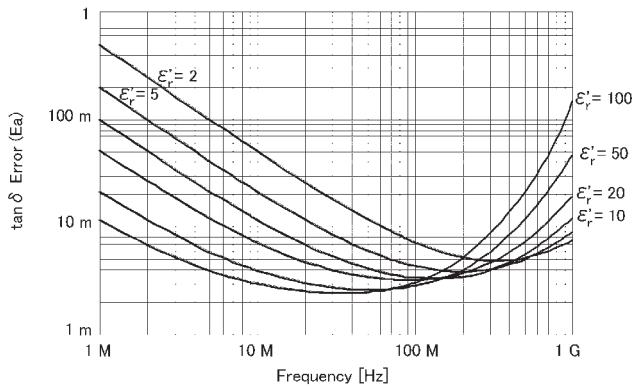

Figure 17. Dielectric loss tangent ( $\tan\delta$ ) accuracy vs. frequency (at  $t = 1$  mm, typical)<sup>1</sup>

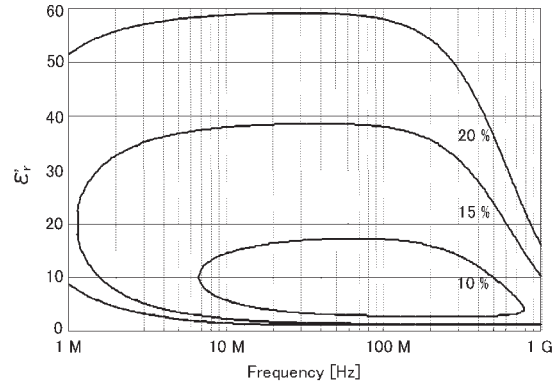

Figure 20. Permittivity ( $\epsilon_r'$ ) vs. frequency (at  $t = 1$  mm, typical)

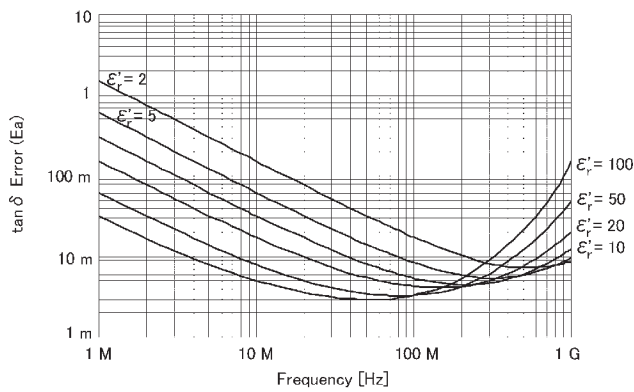

Figure 18. Dielectric loss tangent ( $\tan\delta$ ) accuracy vs. frequency (at  $t = 3$  mm, typical)<sup>1</sup>

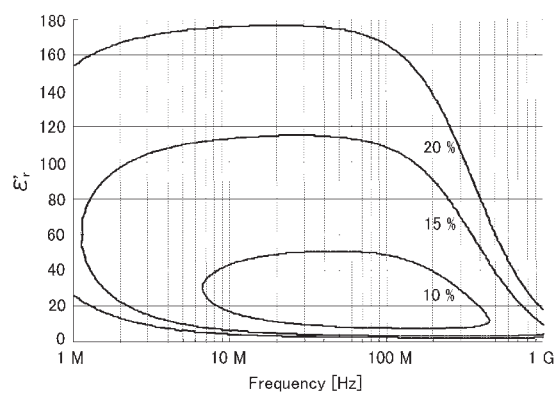

Figure 21. Permittivity ( $\epsilon_r'$ ) vs. frequency (at  $t = 3$  mm, typical)

1. This graph shows only frequency dependence of  $E_a$  to simplify it. The typical accuracy of  $\tan\delta$  is defined as  $E_a + E_b$ ; refer to "Typical accuracy of permittivity parameters" on page 17.

# Option E4991A-002 Material Measurement (typical) (continued)

Examples of calculated permeability measurement accuracy

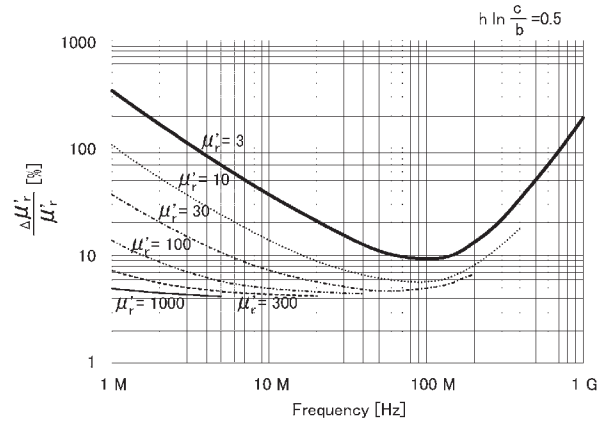

Figure 22. Permeability accuracy ( $\frac{\Delta\mu'_r}{\mu'_r}$ ) vs. frequency (at  $F = 0.5$ , typical)

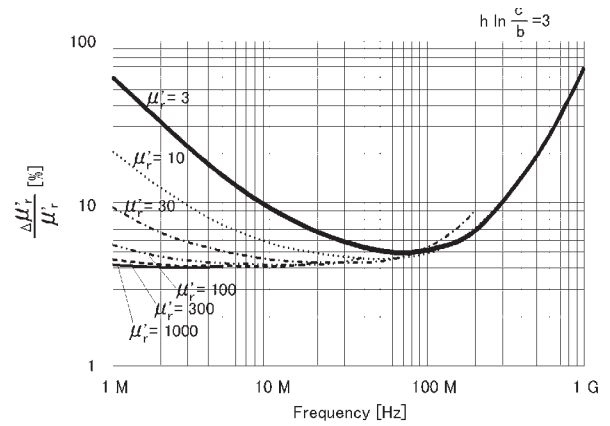

Figure 23. Permeability accuracy ( $\frac{\Delta\mu'_r}{\mu'_r}$ ) vs. frequency (at  $F = 3$ , typical)

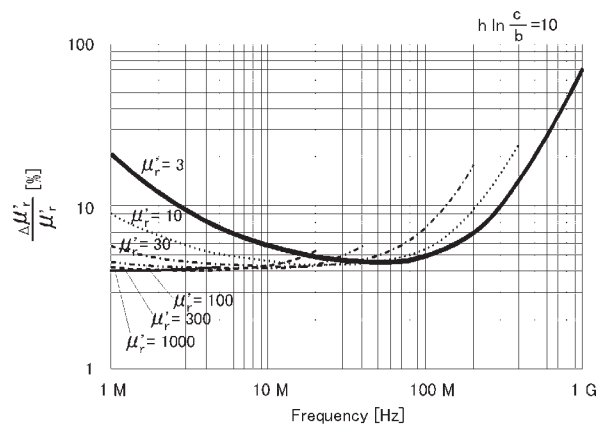

Figure 24. Permeability accuracy ( $\frac{\Delta\mu'_r}{\mu'_r}$ ) vs. frequency (at  $F = 10$ , typical)

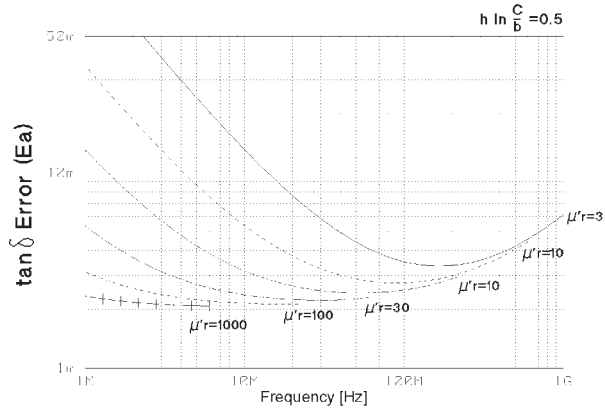

Figure 25. Permeability loss tangent ( $\tan\delta$ ) accuracy vs. frequency (at  $F = 0.5$ , typical)<sup>1</sup>

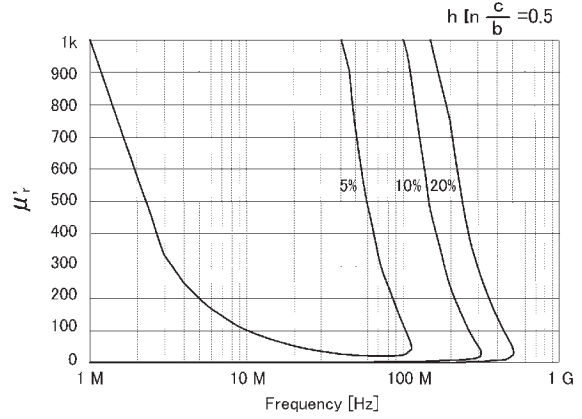

Figure 28. Permeability ( $\mu'_r$ ) vs. frequency (at  $F = 0.5$ , typical)

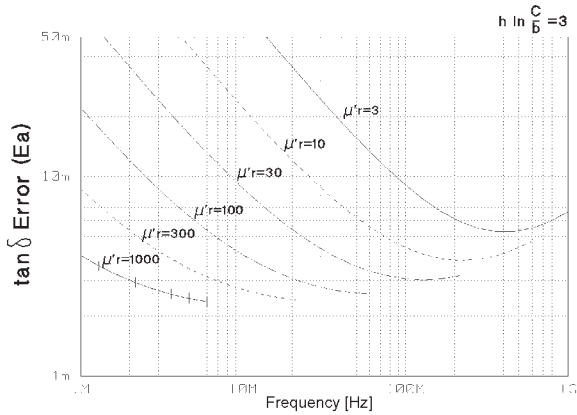

Figure 26. Permeability loss tangent ( $\tan\delta$ ) accuracy vs. frequency (at  $F = 3$ , typical)<sup>1</sup>

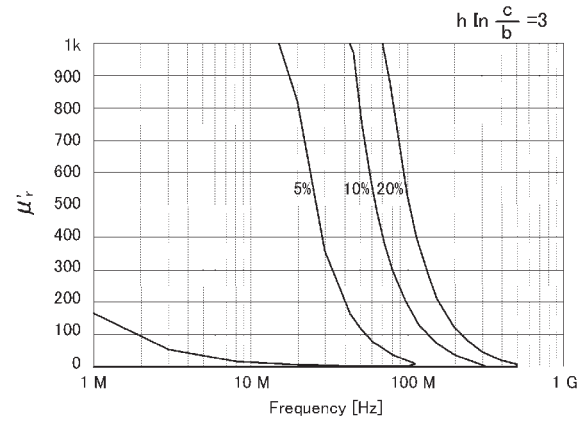

Figure 29. Permeability ( $\mu'_r$ ) vs. frequency (at  $F = 3$ , typical)

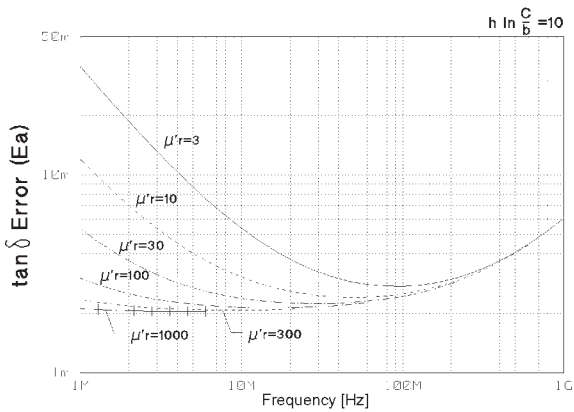

Figure 27. Permeability loss tangent ( $\tan\delta$ ) accuracy vs. frequency (at  $F = 10$ , typical)<sup>1</sup>

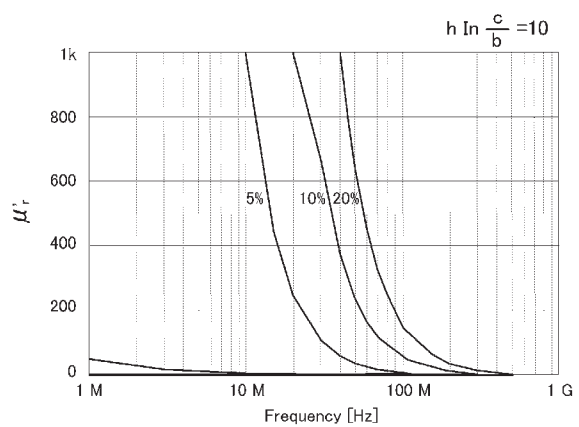

Figure 30. Permeability ( $\mu'_r$ ) vs. frequency (at  $F = 10$ , typical)

1. This graph shows only frequency dependence of  $E_a$  to simplify it. The typical accuracy of  $\tan\delta$  is defined as  $E_a + E_b$ ; refer to "Typical accuracy of permeability parameters" on page 18.

# Option E4991A-007 Temperature Characteristic Test Kit

This section contains specifications and supplemental information for the E4991A Option E4991A-007. Except for the contents in this section, the E4991A standard specifications and supplemental information are applied.

## Operation temperature

### Range:

–55 °C to +150 °C (at the test port of the high temperature cable)

## Source characteristics

### Frequency

Range: 1 MHz to 3 GHz

### Oscillator level

#### Source power accuracy at the test port of the high temperature cable:

Frequency ≤ 1 GHz:

+2 dB/–4 dB (23 °C ±5 °C)

+4 dB/–6 dB (5 °C to 40 °C)

Frequency > 1 GHz:

+3 dB/–6 dB (23 °C ±5 °C)

+5 dB/–8 dB (5 °C to 40 °C)

## Measurement accuracy (at 23 °C ±5 °C)

### Conditions<sup>1</sup>

The measurement accuracy is specified when the following conditions are met:

**Calibration:** open, short and load calibration is completed at the test port (7-mm connector) of the high temperature cable

**Calibration temperature:** calibration is performed at an environmental temperature within the range of 23 °C ±5 °C. Measurement error doubles when calibration temperature is below 18 °C or above 28 °C.

**Measurement temperature range:** within ±5 °C of calibration temperature

**Measurement plane:** same as calibration plane

**Oscillator level:** same as the level set at calibration

### Impedance, admittance and phase angle accuracy:

$|Z|, |Y| \pm (E_a + E_b) [\%]$   
(see Figure 31 through Figure 34 for calculated accuracy)

$\theta \pm \frac{(E_a + E_b)}{100} [\text{rad}]$

where,

$E_a$  = at oscillator level ≥ –33 dBm:

±0.8 [%] (1 MHz ≤  $f$  ≤ 100 MHz)

±1 [%] (100 MHz <  $f$  ≤ 500 MHz)

±1.2 [%] (500 MHz <  $f$  ≤ 1 GHz)

±2.5 [%] (1 GHz <  $f$  ≤ 1.8 GHz)

±5 [%] (1.8 GHz <  $f$  ≤ 3 GHz)

at oscillator level < –33 dBm:

±1.2 [%] (1 MHz ≤  $f$  ≤ 100 MHz)

±1.5 [%] (100 MHz <  $f$  ≤ 500 MHz)

±1.5 [%] (500 MHz <  $f$  ≤ 1 GHz)

±2.5 [%] (1 GHz <  $f$  ≤ 1.8 GHz)

±5 [%] (1.8 GHz <  $f$  ≤ 3 GHz)

(Where,  $f$  is frequency)

$E_b = \pm \left[ \frac{Z_s}{|Z_x|} + Y_o \times |Z_x| \right] \times 100 [\%]$

Where,

$|Z_x|$  = Absolute value of impedance

$Z_s$  = At oscillator level = –3 dBm, –13 dBm, or –23 dBm:

± (30 + 0.5 ×  $F$ ) [mΩ] (point averaging factor ≥ 8)

± (40 + 0.5 ×  $F$ ) [mΩ] (point averaging factor ≤ 7)

At oscillator level ≥ –33 dBm:

± (35 + 0.5 ×  $F$ ) [mΩ] (point averaging factor ≥ 8)

± (70 + 0.5 ×  $F$ ) [mΩ] (point averaging factor ≤ 7)

At oscillator level < –33 dBm:

± (50 + 0.5 ×  $F$ ) [mΩ] (point averaging factor ≥ 8)

± (150 + 0.5 ×  $F$ ) [mΩ] (point averaging factor ≤ 7)

(Where,  $F$  is frequency in MHz)

$Y_o$  = At oscillator level = –3 dBm, –13 dBm, –23 dBm:

± (12 + 0.1 ×  $F$ ) [μS] (point averaging factor ≥ 8)

± (20 + 0.1 ×  $F$ ) [μS] (point averaging factor ≤ 7)

At oscillator level ≥ –33 dBm:

± (15 + 0.1 ×  $F$ ) [μS] (point averaging factor ≥ 8)

± (40 + 0.1 ×  $F$ ) [μS] (point averaging factor ≤ 7)

At oscillator level < –33 dBm:

± (35 + 0.1 ×  $F$ ) [μS] (point averaging factor ≥ 8)

± (80 + 0.1 ×  $F$ ) [μS] (point averaging factor ≤ 7)

(Where,  $F$  is frequency in MHz)

1. The high temperature cable must be kept at the same position throughout calibration and measurement.

# Calculated Impedance/Admittance Measurement Accuracy

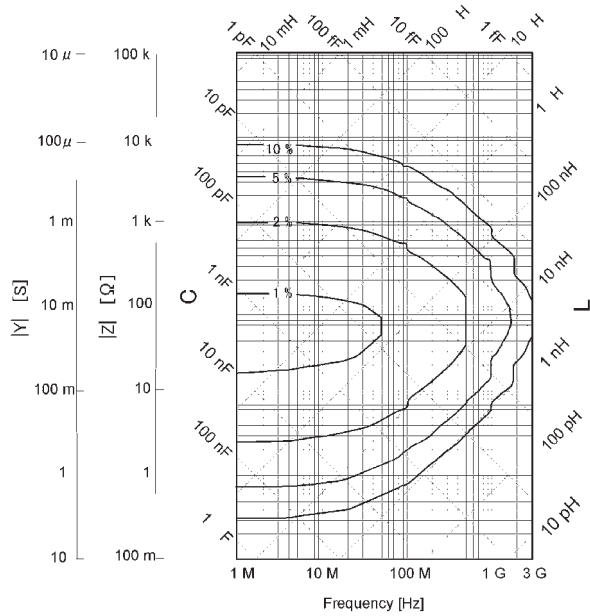

**Figure 31.**  $|Z|$ ,  $|Y|$  measurement accuracy when open/short/load calibration is performed. Oscillator level =  $-23$  dBm,  $-13$  dBm,  $-3$  dBm. Point averaging factor  $\geq 8$  within  $\pm 5$  °C of calibration temperature.

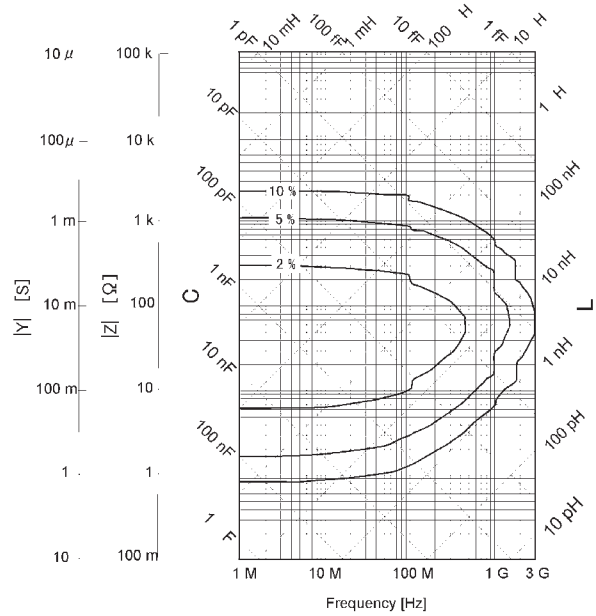

**Figure 33.**  $|Z|$ ,  $|Y|$  measurement accuracy when open/short/load calibration is performed. Oscillator level  $\geq -33$  dBm. Point averaging factor  $\leq 7$  within  $\pm 5$  °C of calibration temperature.

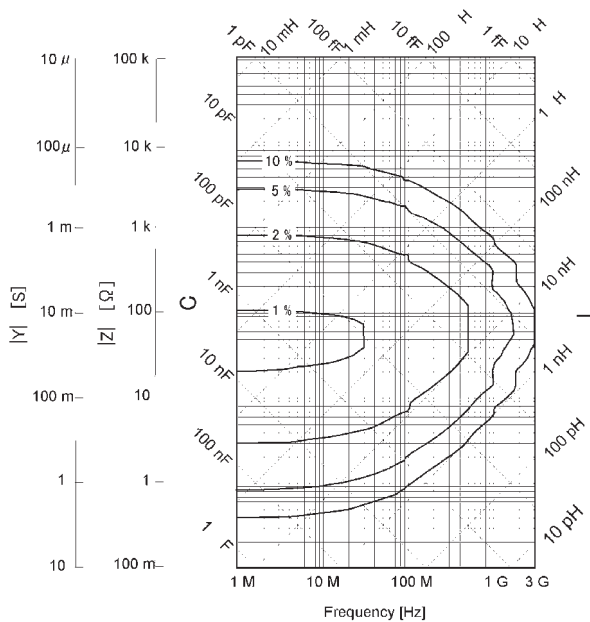

**Figure 32.**  $|Z|$ ,  $|Y|$  measurement accuracy when open/short/load calibration is performed. Oscillator level  $\geq -33$  dBm. Point averaging factor  $\geq 8$  within  $\pm 5$  °C of calibration temperature.

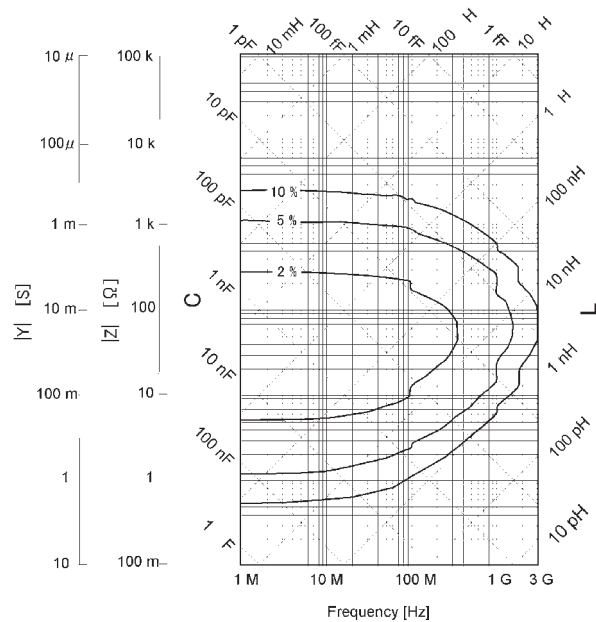

**Figure 34.**  $|Z|$ ,  $|Y|$  measurement accuracy when open/short/load calibration is performed. Oscillator level  $< -33$  dBm. Point averaging factor  $\geq 8$  within  $\pm 5$  °C of calibration temperature.



## Typical Effects of Temperature Change on Measurement Accuracy

When the temperature at the test port (7-mm connector) of the high temperature cable changes from the calibration temperature, typical measurement accuracy involving temperature dependence effects (errors) is applied. The typical measurement accuracy is represented by the sum of error due to temperature coefficients ( $E_a'$ ,  $Y_o'$  and  $Z_s'$ ), hysteresis error ( $E_{ah}$ ,  $Y_{oh}$  and  $Z_{sh}$ ) and the specified accuracy.

### Conditions

The typical measurement accuracy is applied when the following conditions are met:

#### Conditions of $E_a'$ , $Z_s'$ and $Y_o'$ :

**Measurement temperature:**  $-55\text{ }^{\circ}\text{C}$  to  $5\text{ }^{\circ}\text{C}$  or  $40\text{ }^{\circ}\text{C}$  to  $150\text{ }^{\circ}\text{C}$  at test port. For  $5\text{ }^{\circ}\text{C}$  to  $40\text{ }^{\circ}\text{C}$ ,  $E_a'$ ,  $Y_o'$  and  $Z_s'$  are 0 (neglected).

**Temperature change:**  $\geq 5\text{ }^{\circ}\text{C}$  from calibration temperature when the temperature compensation is off.  
 $\geq 20\text{ }^{\circ}\text{C}$  from calibration temperature when the temperature compensation is set to on.

**Calibration temperature:**  $23\text{ }^{\circ}\text{C} \pm 5\text{ }^{\circ}\text{C}$

**Calibration mode:** user calibration

**Temperature compensation:** temperature compensation data is acquired at the same temperature points as measurement temperatures.

#### Conditions of $E_{ah}$ , $Z_{sh}$ and $Y_{oh}$ :

**Measurement temperature:**  $-55\text{ }^{\circ}\text{C}$  to  $150\text{ }^{\circ}\text{C}$  at the test port

**Calibration temperature:**  $23\text{ }^{\circ}\text{C} \pm 5\text{ }^{\circ}\text{C}$

**Calibration mode:** user calibration

**Typical measurement accuracy (involving temperature dependence effects)<sup>1</sup>:**

$$|Z|, |Y|: \pm (E_a + E_b + E_c + E_d) [\%]$$

$$\theta : \pm \frac{(E_a + E_b + E_c + E_d)}{100} [\text{rad}]$$

Where,

$$E_c = E_a' \times \Delta T + E_{ah}$$

$$E_d = \pm \left[ \frac{Z_s' \times \Delta T + Z_{sh}}{|Z_x|} + (Y_o' \times \Delta T + Y_{oh}) \times |Z_x| \right] \times 100 [\%]$$

Where,

$$|Z_x| = \text{Absolute value of measured impedance}$$

Here,  $E_a'$ ,  $Z_s'$  and  $Y_o'$  are given by the following equations:

	Without temperature compensation	With temperature compensation	
		1 MHz ≤ f < 500 MHz	500 MHz ≤ f ≤ 3 GHz
$E_a'$	0.006 + 0.015 × f [%/°C]	0.006 + 0.015 × f [%/°C]	0.006 + 0.015 × f [%/°C]
$Z_s'$	1 + 10 × f [mΩ/°C]	1 + 10 × f [mΩ/°C]	5 + 2 × f [mΩ/°C]
$Y_o'$	0.3 + 3 × f [μS/°C]	0.3 + 3 × f [μS/°C]	1.5 + 0.6 × f [μS/°C]

$f$  = Measurement frequency in GHz

$E_{ah}$ ,  $Z_{sh}$  and  $Y_{oh}$  are given by following equations:

$$E_{ah} = E_a' \times \Delta T_{max} \times 0.3 [\%]$$

$$Z_{sh} = Z_s' \times \Delta T_{max} \times 0.3 [\text{m}\Omega]$$

$$Y_{oh} = Y_o' \times \Delta T_{max} \times 0.3 [\mu\text{S}]$$

$\Delta T$  = Difference of measurement temperature-from calibration temperature

$\Delta T_{max}$  = Maximum temperature change (°C) at the test port from calibration temperature after the calibration is performed.

Typical Frequency Characteristics of Temperature Coefficient

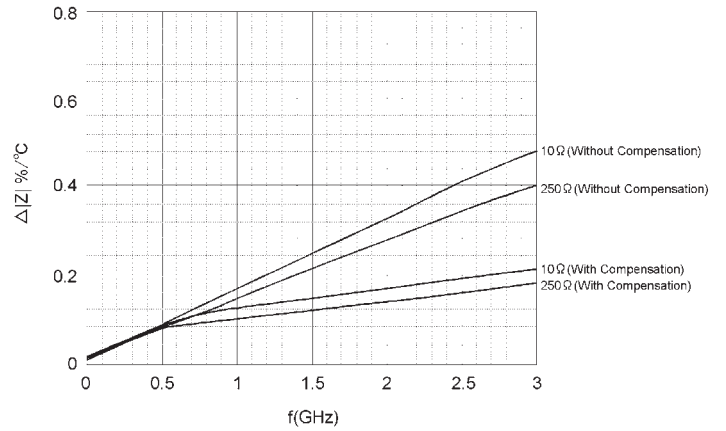

**Figure 35. Typical frequency characteristics of temperature coefficient,  $(E_c+E_d)/\Delta T$ , when  $|Z_x| = 10 \Omega$  and  $250 \Omega$ ,  $E_{ah} = Z_{sh} = Y_{oh} = 0$  are assumed<sup>2</sup>.**

1. See graphs in Figure 35 for the calculated values of  $(E_c+E_d)$  exclusive of the hysteresis errors  $E_{ah}$ ,  $Z_{sh}$  and  $Y_{oh}$ , when measured impedance is 10 Ω and 250 Ω.

2. Read the value of  $\Delta|Z|/\%^\circ\text{C}$  at the material measurement frequency and multiply it by  $\Delta T$  to derive the value of  $(E_c+E_d)$  when  $E_{ah} = Y_{oh} = Z_{sh} = 0$ .

# Typical Material Measurement Accuracy When Using Options E4991A-002 and E4991A-007

Material measurement accuracy contains the permittivity and permeability measurement accuracy when the E4991A with Option E4991A-002 and E4991A-007 is used with the 16453A or 16454A test fixture.

## Measurement parameter

**Permittivity parameters:**  $|\epsilon_r|$ ,  $\epsilon'_r$ ,  $\epsilon''$ ,  $\tan\delta$

**Permeability parameters:**  $|\mu_r|$ ,  $\mu'_r$ ,  $\mu''$ ,  $\tan\delta$

## Frequency

**Use with Agilent 16453A:** 1 MHz to 1 GHz (typical)

**Use with Agilent 16454A:** 1 MHz to 1 GHz (typical)

## Operation temperature

**Range:** -55 °C to +150 °C

(at the test port of the high temperature cable)

## Typical material measurement accuracy (at 23 °C ±150 °C)

### Conditions

**The measurement accuracy is specified when the following conditions are met:**

**Calibration:** Open, short and load calibration is completed at the test port (7-mm connector) of the high temperature cable

**Calibration temperature:** Calibration is performed at an environmental temperature within the range of 23 °C ±5 °C. Measurement error doubles when calibration temperature is below 18 °C or above 28 °C.

**Measurement temperature range:** Within ±5 °C of calibration temperature

**Measurement frequency points:** Same as calibration points (User Cal)

**Oscillator level:** Same as the level set at calibration

**Point averaging factor:** ≥ 8

## Typical permittivity measurement accuracy<sup>1</sup>:

$$\epsilon'_r \text{ accuracy} \quad \left( E_\epsilon = \frac{\Delta\epsilon'_{rm}}{\epsilon'_{rm}} \right)$$

$$\pm \left[ 5 + \left( 10 + \frac{0.5}{f} \right) \times \frac{t}{\epsilon'_{rm}} + 0.25 \times \frac{\epsilon'_{rm}}{t} + \frac{100}{\left| 1 - \left( \frac{13}{f \sqrt{\epsilon'_{rm}}} \right)^2 \right|} \right]$$

[%] (at  $\tan\delta < 0.1$ )

Loss tangent accuracy of  $\dot{\epsilon}_r (= \Delta\tan\delta)$  :

$$\pm (E_a + E_b) \text{ (at } \tan\delta < 0.1)$$

where,

$$E_a =$$

at Frequency ≤ 1 GHz

$$0.002 + \frac{0.0025}{f} \times \frac{t}{\epsilon'_{rm}} + (0.008 \times f) + \frac{0.1}{\left| 1 - \left( \frac{13}{f \sqrt{\epsilon'_{rm}}} \right)^2 \right|}$$

$$E_b = \left[ \frac{\Delta\epsilon'_{rm}}{\epsilon'_{rm}} \times \frac{1}{100} + \epsilon'_{rm} \frac{0.002}{t} \right] \times \tan\delta$$

$f$  = Measurement frequency [GHz]

$t$  = Thickness of MUT (material under test) [mm]

$\epsilon'_{rm}$  = Measured value of  $\epsilon'_r$

$\tan\delta$  = Measured value of dielectric loss tangent

1. The accuracy applies when the electrode pressure of the 16453A is set to maximum.

**Typical permeability measurement accuracy:**

$$\mu_r' \text{ accuracy} \quad E_\mu = \left( \frac{\Delta \mu_{rm}'}{\mu_{rm}'} \right):$$
$$4 + \frac{0.02}{f} \times \frac{25}{F \times \mu_{rm}'} + F \times \mu_{rm}' \times \left( 1 + \frac{15}{F \times \mu_{rm}'} \right)^2 \times f^2$$

[%] (at  $\tan\delta < 0.1$ )

Loss tangent accuracy of  $\dot{\mu}_r$  ( $= \Delta \tan\delta$ ) :

$$\pm (E_a + E_b) \text{ (at } \tan\delta < 0.1)$$

where,

$$E_a = 0.002 + \frac{0.005}{F \times \mu_{rm}' \times f} + 0.004 \times f$$

$$E_b = \frac{\Delta \mu_{rm}'}{\mu_{rm}'} \times \frac{\tan\delta}{100}$$

$f$  = Measurement frequency [GHz]

$$F = h \ln \frac{c}{b} \text{ [mm]}$$

$h$  = Height of MUT (material under test) [mm]

$b$  = Inner diameter of MUT [mm]

$c$  = Outer diameter of MUT [mm]

$\mu_{rm}'$  = Measured value of  $\mu_r'$

$\tan\delta$  = Measured value of loss tangent

# Examples of Calculated Permittivity Measurement Accuracy

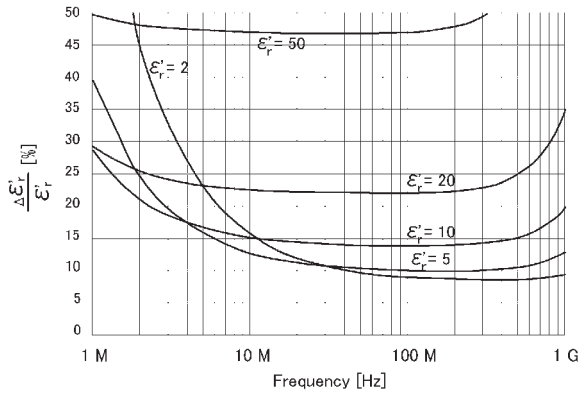

Figure 36. Permittivity accuracy ( $\frac{\Delta \epsilon'_r}{\epsilon'_r}$ ) vs. frequency, (at  $t = 0.3$  mm typical)

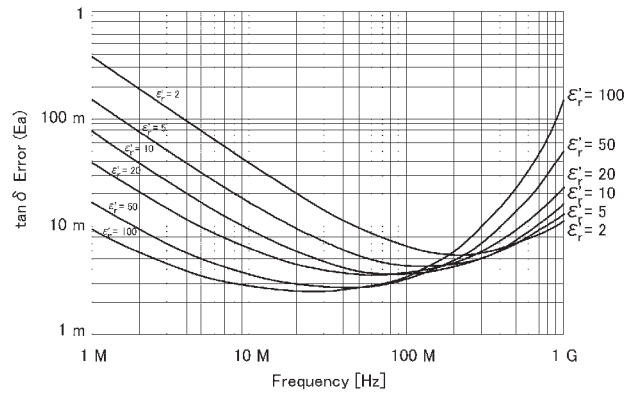

Figure 39. Dielectric loss tangent ( $\tan \delta$ ) accuracy vs. frequency (at  $t = 0.3$  mm, typical)<sup>1</sup>

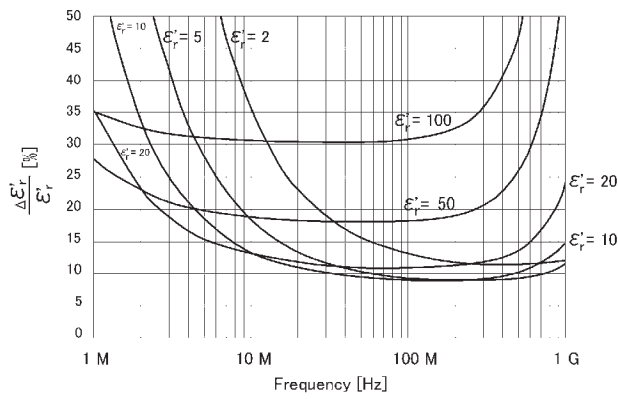

Figure 37. Permittivity accuracy ( $\frac{\Delta \epsilon'_r}{\epsilon'_r}$ ) vs. frequency (at  $t = 1$  mm, typical)

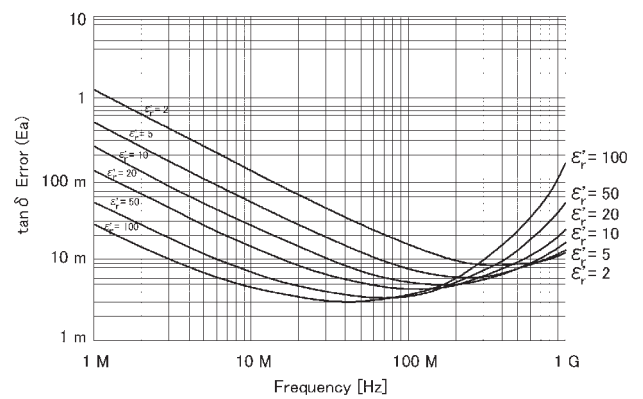

Figure 40. Dielectric loss tangent ( $\tan \delta$ ) accuracy vs. frequency (at  $t = 1$  mm, typical)<sup>1</sup>

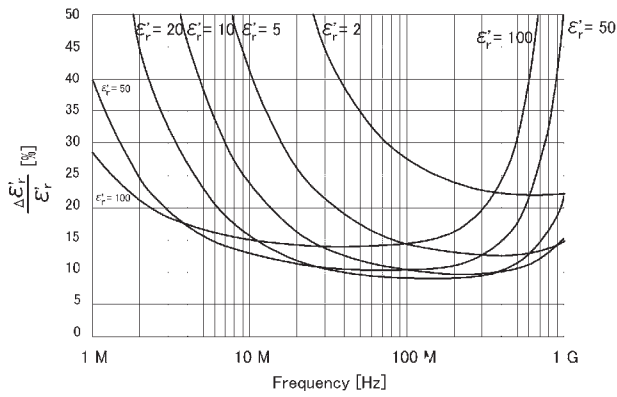

Figure 38. Permittivity accuracy ( $\frac{\Delta \epsilon'_r}{\epsilon'_r}$ ) vs. frequency (at  $t = 3$  mm, typical)

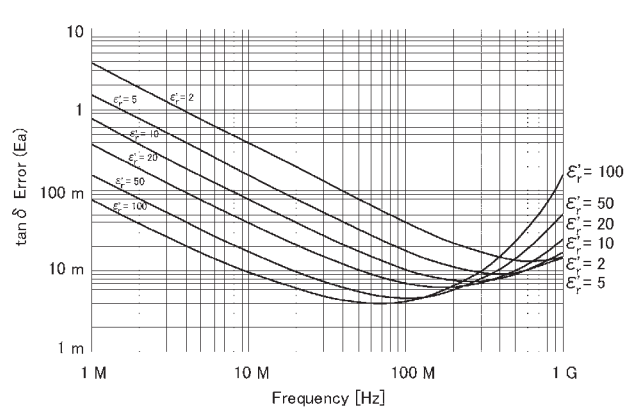

Figure 41. Dielectric loss tangent ( $\tan \delta$ ) accuracy vs. frequency (at  $t = 3$  mm, typical)<sup>1</sup>

1. This graph shows only frequency dependence of  $E_a$  for simplification. The typical accuracy of  $\tan \delta$  is defined as  $E_a + E_b$ ; refer to "Typical permittivity measurement accuracy" on page 27.

## Examples of Calculated Permittivity Measurement Accuracy (*continued*)

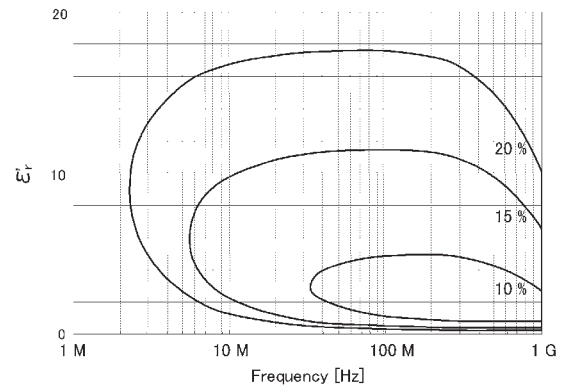

Figure 42. Permittivity ( $\epsilon'_r$ ) vs. frequency (at  $t = 0.3$  mm, typical)

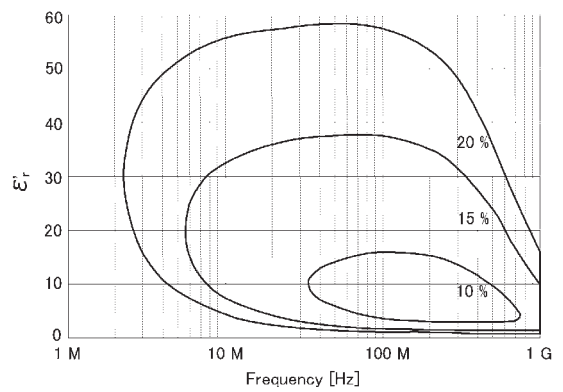

Figure 43. Permittivity ( $\epsilon'_r$ ) vs. frequency (at  $t = 1$  mm, typical)

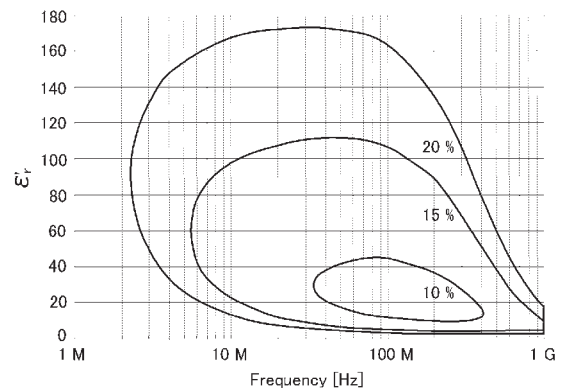

Figure 44. Permittivity ( $\epsilon'_r$ ) vs. frequency (at  $t = 3$  mm, typical)

# Examples of Calculated Permeability Measurement Accuracy

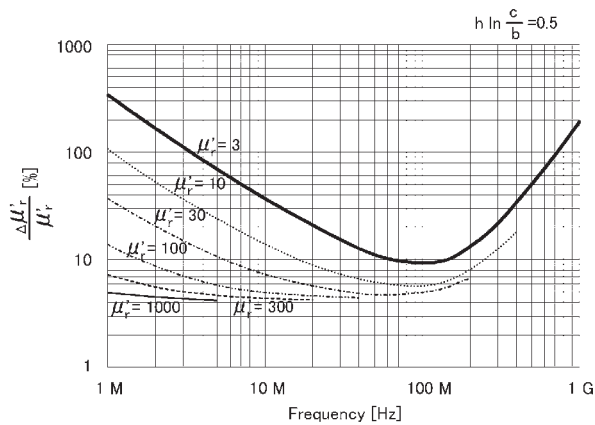

Figure 45. Permeability accuracy ( $\frac{\Delta\mu_r}{\mu_r}$ ) vs. frequency (at  $F = 0.5$ , typical)

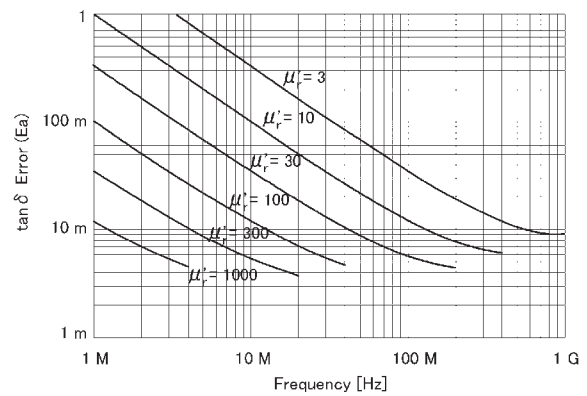

Figure 48. Permeability loss tangent ( $\tan\delta$ ) accuracy vs. frequency (at  $F = 0.5$ , typical)<sup>1</sup>

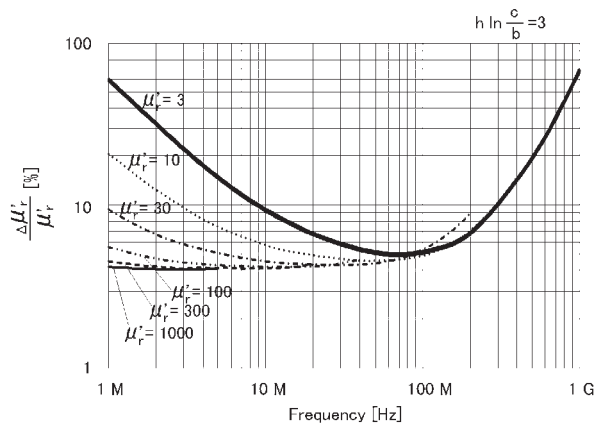

Figure 46. Permeability accuracy ( $\frac{\Delta\mu_r}{\mu_r}$ ) vs. frequency (at  $F = 3$ , typical)

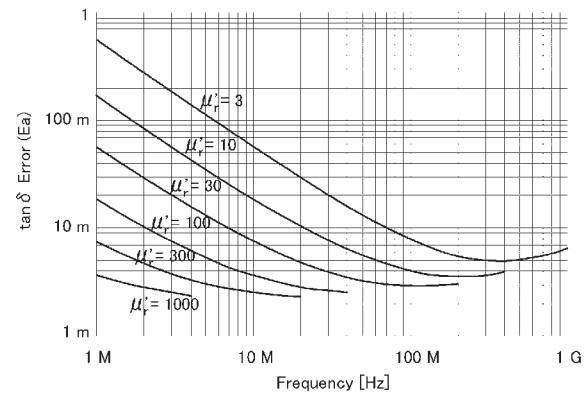

Figure 49. Permeability loss tangent ( $\tan\delta$ ) accuracy vs. frequency (at  $F = 3$ , typical)<sup>1</sup>

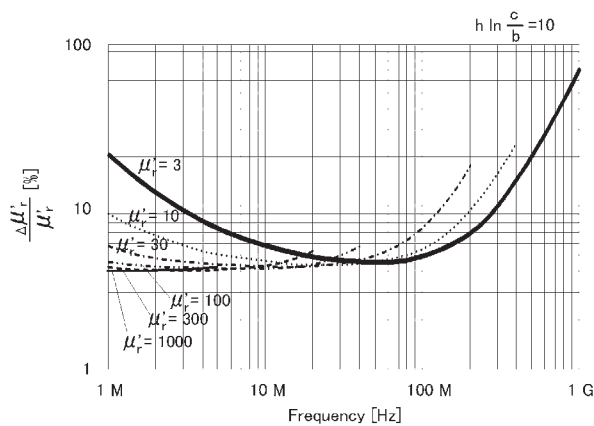

Figure 47. Permeability accuracy ( $\frac{\Delta\mu_r}{\mu_r}$ ) vs. frequency (at  $F = 10$ , typical)

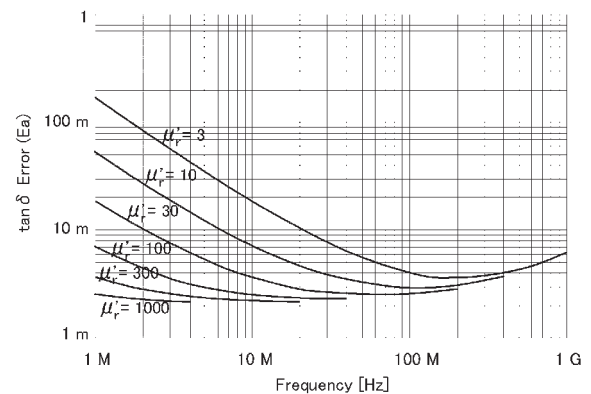

Figure 50. Permeability loss tangent ( $\tan\delta$ ) accuracy vs. Frequency (at  $F = 10$ , typical)<sup>1</sup>

1. This graph shows only frequency dependence of  $E_a$  for simplification. The typical accuracy of  $\tan\delta$  is defined as  $E_a + E_b$ ; refer to "Typical permeability measurement accuracy" on page 28.

## Examples of Calculated Permeability Measurement Accuracy (*continued*)

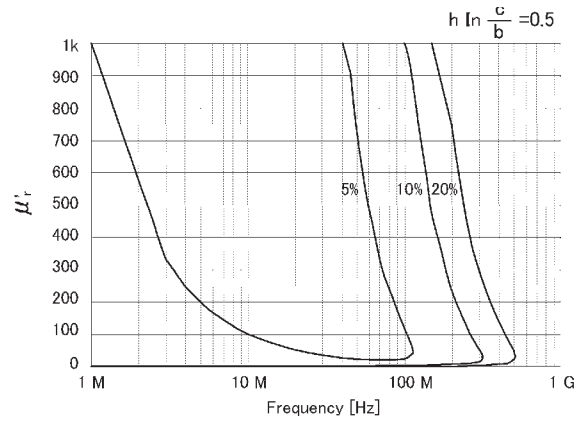

Figure 51. Permeability ( $\mu_r$ ) vs. frequency (at  $F = 0.5$ , typical)

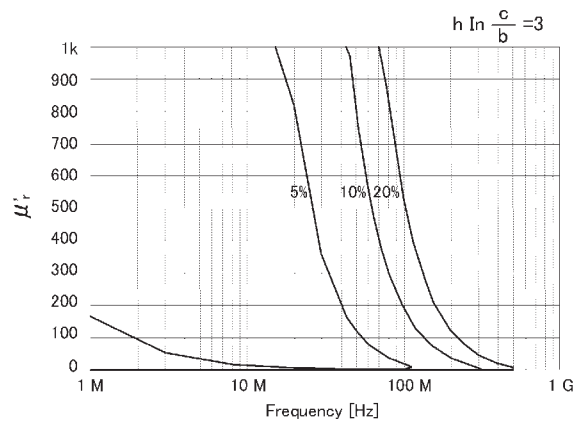

Figure 52. Permeability ( $\mu_r$ ) vs. frequency (at  $F = 3$ , typical)

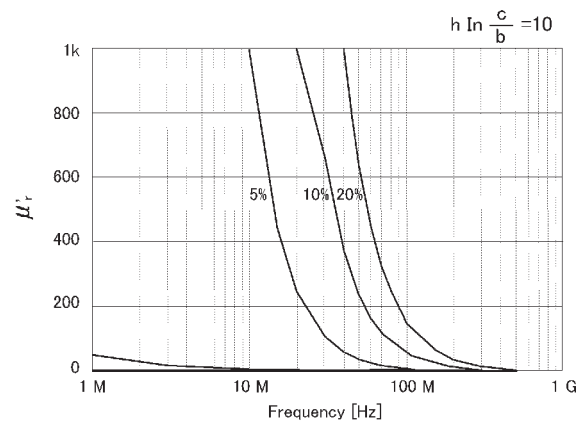

Figure 53. Permeability ( $\mu_r$ ) vs. frequency (at  $F = 10$ , typical)



## Typical Effects of Temperature Change on Permittivity Measurement Accuracy

When the temperature at the test port (7-mm connector) of the high temperature cable changes more than 5 °C from the calibration temperature, the typical permittivity measurement accuracy involving temperature dependence effects (errors) is applied. The typical permittivity accuracy is represented by the sum of error due to temperature coefficient ( $T_c$ ), hysteresis error ( $T_c \times \Delta T_{max}$ ) and the accuracy at 23 °C  $\pm$  5 °C.

**Typical accuracy of permittivity parameters:**

$$\varepsilon_r' \text{ accuracy } \left( = \frac{\Delta \varepsilon_{rm}'}{\varepsilon_{rm}'} \right) : \\ \pm (E_\varepsilon + E_f + E_g) \text{ [\%]}$$

Loss tangent accuracy of  $\varepsilon'' (= \Delta \tan \delta)$  :

$$\pm \frac{(E_\varepsilon + E_f + E_g)}{100}$$

where,

$$E_\varepsilon = \text{Permittivity measurement accuracy at } 23 \text{ }^\circ\text{C} \pm 5 \text{ }^\circ\text{C}$$

$$E_f = T_c \times \Delta T$$

$$E_g = T_c \times \Delta T_{max} \times 0.3$$

$$T_c = K_1 + K_2 + K_3$$

See Figure 54 through Figure 56 for the calculated value of  $T_c$  without temperature compensation

$$K_1 = 1 \times 10^{-6} \times (60 + 150 \times f)$$

$$K_2 =$$

$$3 \times 10^{-6} \times (1 + 10 \times f) \times \left( \frac{\varepsilon_{rm}'}{t} \times \frac{1}{\left| 1 - \left( \frac{f}{f_o} \right)^2 \right|} + 10 \right) \times f$$

$$K_3 =$$

$$5 \times 10^{-3} \times (0.3 + 3 \times f) \times \frac{1}{\left( \frac{\varepsilon_{rm}'}{t} \times \frac{1}{\left| 1 - \left( \frac{f}{f_o} \right)^2 \right|} + 10 \right) \times f}$$

**Typical accuracy of permittivity parameters (continued):**

with temperature compensation

$$K_1 = 1 \times 10^{-6} \times (60 + 150 \times f)$$

$$K_2 = 1 \text{ MHz} \leq f < 500 \text{ MHz}$$

$$3 \times 10^{-6} \times (1 + 10 \times f) \times \left( \frac{\epsilon'_{rm}}{t} \times \frac{1}{\left| 1 - \left( \frac{f}{f_o} \right)^2 \right|} + 10 \right) \times f$$

$$500 \text{ MHz} \leq f \leq 1 \text{ GHz}$$

$$3 \times 10^{-6} \times (5 + 2 \times f) \times \left( \frac{\epsilon'_{rm}}{t} \times \frac{1}{\left| 1 - \left( \frac{f}{f_o} \right)^2 \right|} + 10 \right) \times f$$

$$K_3 = 1 \text{ MHz} \leq f < 500 \text{ MHz}$$

$$\frac{1}{5 \times 10^{-3} \times (0.3 + 3 \times f) \times \left( \frac{\epsilon'_{rm}}{t} \times \frac{1}{\left| 1 - \left( \frac{f}{f_o} \right)^2 \right|} + 10 \right) \times f}$$

$$500 \text{ MHz} \leq f \leq 1 \text{ GHz}$$

$$\frac{1}{5 \times 10^{-3} \times (1.5 + 0.6 \times f) \times \left( \frac{\epsilon'_{rm}}{t} \times \frac{1}{\left| 1 - \left( \frac{f}{f_o} \right)^2 \right|} + 10 \right) \times f}$$

$f$  = Measurement frequency [GHz]

$$f_o = \frac{13}{\sqrt{\epsilon'_r}} \text{ [GHz]}$$

$t$  = Thickness of MUT (material under test) [mm]

$\epsilon'_{rm}$  = Measured value of  $\epsilon'_r$

$\Delta T$  = Difference of measurement temperature from calibration temperature

$\Delta T_{max}$  = Maximum temperature change (°C) at test port from calibration temperature after the calibration is performed.

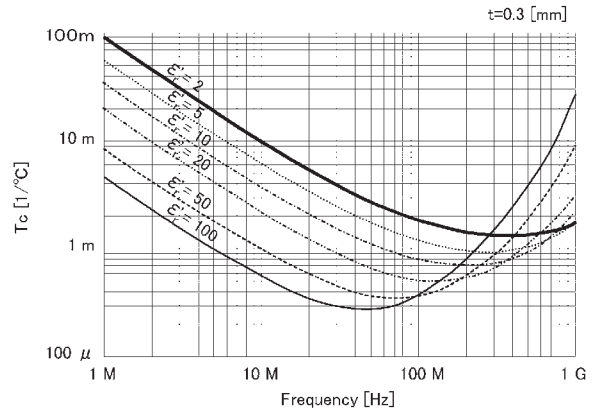

**Figure 54. Typical frequency characteristics of temperature coefficient of  $\epsilon'_r$  (Thickness = 0.3 mm)**

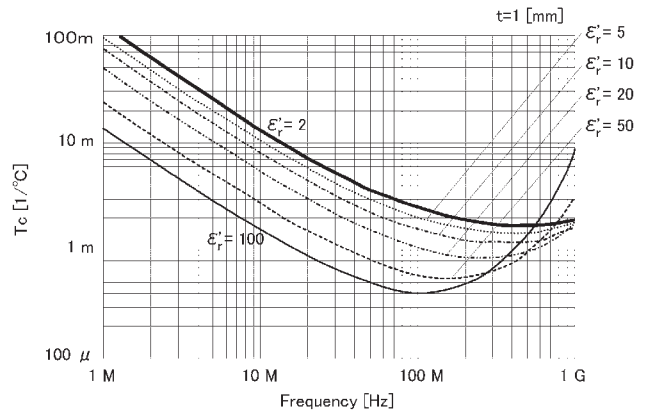

**Figure 55. Typical frequency characteristics of temperature coefficient of  $\epsilon'_r$  (Thickness = 1 mm)**

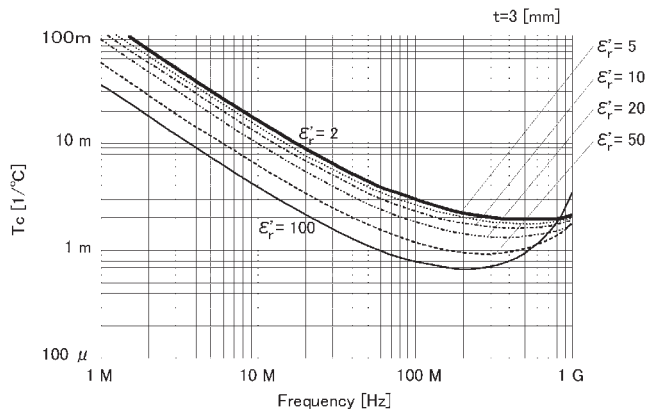

**Figure 56. Typical frequency characteristics of temperature coefficient of  $\epsilon'_r$  (Thickness = 3 mm)**

## Typical Effects of Temperature Change on Permeability Measurement Accuracy

When the temperature at the test port (7-mm connector) of the high temperature cable changes more than 5 °C from the calibration temperature, the typical permeability measurement accuracy involving temperature dependence effects (errors) is applied. The typical permeability accuracy is represented by the sum of error due to temperature coefficient ( $T_c$ ), hysteresis error ( $T_c \times \Delta T_{max}$ ) and the accuracy at 23 °C  $\pm 5$  °C.

### Typical accuracy of permeability parameters:

$$\mu_r' \text{ accuracy} \left( = \frac{\Delta \mu_{rm}'}{\mu_{rm}'} \right):$$

$$\pm (E_\mu + E_h + E_i) [\%]$$

Loss tangent accuracy of  $\mu_r (= \Delta \tan \delta)$  :

$$\pm \frac{(E_\mu + E_h + E_i)}{100}$$

where,

$$E_\mu = \text{Permeability measurement accuracy at } 23 \text{ }^\circ\text{C} \pm 5 \text{ }^\circ\text{C}$$

$$E_h = T_c \times \Delta T$$

$$E_i = T_c \times \Delta T_{max} \times 0.3$$

$$T_c = K_4 + K_5 + K_6$$

See Figure 57 through Figure 59 for the calculated value of  $T_c$

without temperature compensation

$$K_4 = 1 \times 10^{-6} \times (60 + 150 \times f)$$

$$K_5 =$$

$$1 \times 10^{-2} \times (1 + 10 \times f) \times \frac{|1 - 0.01 \times \{F \times (\mu_{rm}' - 1) + 10\} \times f^2|}{\{F \times (\mu_{rm}' - 1) + 20\} \times f}$$

$$K_6 =$$

$$2 \times 10^{-6} \times (0.3 + 3 \times f) \times \frac{\{F \times (\mu_{rm}' - 1) + 20\} \times f}{|1 - 0.01 \times \{F \times (\mu_{rm}' - 1) + 10\} \times f^2|}$$

with temperature compensation

$$K_4 = 1 \times 10^{-6} \times (60 + 150 \times f)$$

$$K_5 =$$

$$1 \text{ MHz} \leq f < 500 \text{ MHz}$$

$$1 \times 10^{-2} \times (1 + 10 \times f) \times \frac{|1 - 0.01 \times \{F \times (\mu_{rm}' - 1) + 10\} \times f^2|}{\{F \times (\mu_{rm}' - 1) + 20\} \times f}$$

$$500 \text{ MHz} \leq f \leq 1 \text{ GHz}$$

$$1 \times 10^{-2} \times (5 + 2 \times f) \times \frac{|1 - 0.01 \times \{F \times (\mu_{rm}' - 1) + 10\} \times f^2|}{\{F \times (\mu_{rm}' - 1) + 20\} \times f}$$

**Typical accuracy of permeability parameters (continued):**

$$K_{\delta} = 1 \text{ MHz} \leq f < 500 \text{ MHz}$$
$$2 \times 10^{-6} \times (0.3 + 3 \times f) \times \frac{\{F \times (\mu'_{rm} - 1) + 20\} \times f}{|1 - 0.01 \times \{F \times (\mu'_{rm} - 1) + 10\} \times f^2|}$$

$$500 \text{ MHz} \leq f \leq 1 \text{ GHz}$$

$$2 \times 10^{-6} \times (1.5 + 0.6 \times f) \times \frac{\{F \times (\mu'_{rm} - 1) + 20\} \times f}{|1 - 0.01 \times \{F \times (\mu'_{rm} - 1) + 10\} \times f^2|}$$

$$f = \text{Measurement frequency [GHz]}$$

$$F = h \ln \frac{c}{b} [\text{mm}]$$

$$h = \text{Height of MUT (material under test) [mm]}$$

$$b = \text{Inner diameter of MUT [mm]}$$

$$c = \text{Outer diameter of MUT [mm]}$$

$$\mu' = \text{Measured value of } \mu'_r$$

$$\Delta T = \text{Difference of measurement temperature from calibration temperature}$$

$$\Delta T_{max} = \text{Maximum temperature change (}^\circ\text{C) at test port from calibration temperature after the calibration is performed.}$$

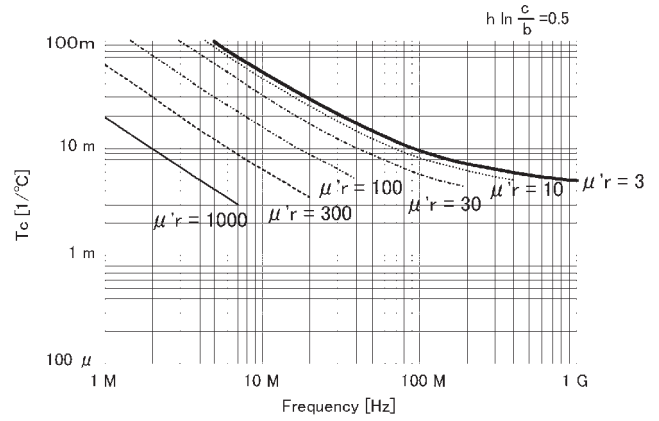

**Figure 57. Typical frequency characteristics of temperature coefficient of  $\mu'_r$  (at  $F = 0.5$ )**

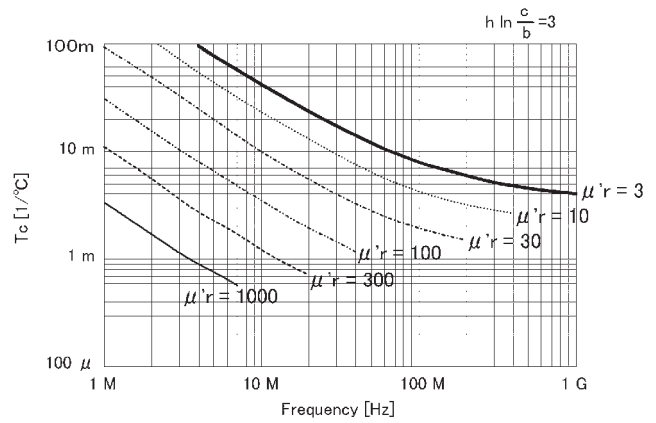

**Figure 58. Typical frequency characteristics of temperature coefficient of  $\mu'_r$  (at  $F = 3$ )**

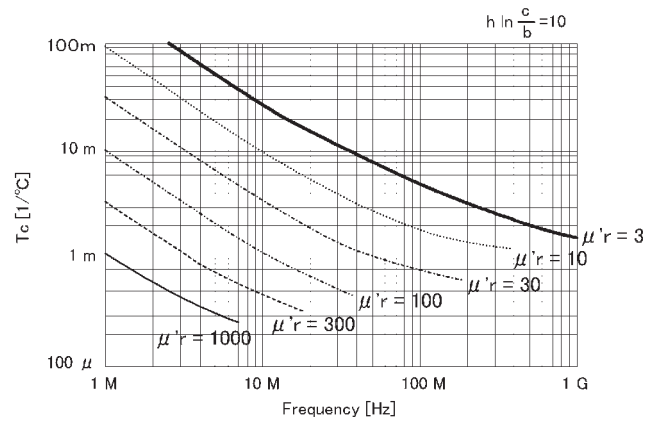

**Figure 59. Typical frequency characteristics of temperature coefficient of  $\mu'_r$  (at  $F = 10$ )**



### Agilent Email Updates

[www.agilent.com/find/emailupdates](http://www.agilent.com/find/emailupdates)

Get the latest information on the products and applications you select.



[www.lxistandard.org](http://www.lxistandard.org)

LAN eXtensions for Instruments puts the power of Ethernet and the Web inside your test systems. Agilent is a founding member of the LXI consortium.

### Agilent Channel Partners

[www.agilent.com/find/channelpartners](http://www.agilent.com/find/channelpartners)

Get the best of both worlds: Agilent's measurement expertise and product breadth, combined with channel partner convenience.



Agilent Advantage Services is committed to your success throughout your equipment's lifetime. To keep you competitive, we continually invest in tools and processes that speed up calibration and repair and reduce your cost of ownership. You can also use Infoline Web Services to manage equipment and services more effectively. By sharing our measurement and service expertise, we help you create the products that change our world.

[www.agilent.com/find/advantageservices](http://www.agilent.com/find/advantageservices)



[www.agilent.com/quality](http://www.agilent.com/quality)

[www.agilent.com](http://www.agilent.com)

[www.agilent.com/find/impedance](http://www.agilent.com/find/impedance)

For more information on Agilent Technologies' products, applications or services, please contact your local Agilent office.

The complete list is available at:

[www.agilent.com/find/contactus](http://www.agilent.com/find/contactus)

#### Americas

Canada	(877) 894 4414
Brazil	(11) 4197 3500
Mexico	01800 5064 800
United States	(800) 829 4444

#### Asia Pacific

Australia	1 800 629 485
China	800 810 0189
Hong Kong	800 938 693
India	1 800 112 929
Japan	0120 (421) 345
Korea	080 769 0800
Malaysia	1 800 888 848
Singapore	1 800 375 8100
Taiwan	0800 047 866
Other AP Countries	(65) 375 8100

#### Europe & Middle East

Belgium	32 (0) 2 404 93 40
Denmark	45 70 13 15 15
Finland	358 (0) 10 855 2100
France	0825 010 700*
	*0.125 €/minute
Germany	49 (0) 7031 464 6333
Ireland	1890 924 204
Israel	972-3-9288-504/544
Italy	39 02 92 60 8484
Netherlands	31 (0) 20 547 2111
Spain	34 (91) 631 3300
Sweden	0200-88 22 55
United Kingdom	44 (0) 131 452 0200

For other unlisted Countries:

[www.agilent.com/find/contactus](http://www.agilent.com/find/contactus)

Revised: June 8, 2011

Product specifications and descriptions in this document subject to change without notice.

© Agilent Technologies, Inc. 2011  
Published in USA, June 13, 2011  
5980-1233E



Agilent Technologies